

### FEATURES

#### Gain set with 1 resistor

Gain = 5 to 1000

#### Inputs

Voltage range to 150 mV below negative rail

25 nA maximum input bias current

30 nV/ $\sqrt{\text{Hz}}$ , RTI noise @ 1 kHz

#### Power supplies

Dual supply:  $\pm 2\text{ V}$  to  $\pm 12\text{ V}$

Single supply: 3 V to 24 V

500  $\mu\text{A}$  maximum supply current

### APPLICATIONS

Low power medical instrumentation

Transducer interface

Thermocouple amplifiers

Industrial process controls

Difference amplifiers

Low power data acquisition

### CONNECTION DIAGRAM

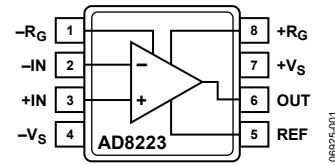

Figure 1. 8-Lead SOIC (R) and 8-Lead MSOP (RM) Packages

Table 1. Instrumentation Amplifiers by Category

General-Purpose	Zero Drift	Mil Grade	Low Power	High Voltage PGA
AD8220 <sup>1</sup>	AD8231 <sup>1</sup>	AD620	AD627 <sup>1</sup>	AD8250
AD8221	AD8553 <sup>1</sup>	AD621	AD623 <sup>1</sup>	AD8251
AD8222	AD8555 <sup>1</sup>	AD524	AD8223	AD8253
AD8224 <sup>1</sup>	AD8556 <sup>1</sup>	AD526		
AD8228	AD8557 <sup>1</sup>	AD624		

<sup>1</sup> Rail-to-rail output.

### GENERAL DESCRIPTION

The AD8223 is an integrated single-supply instrumentation amplifier that delivers rail-to-rail output swing on a single supply (3 V to 24 V). The AD8223 conforms to the 8-lead industry standard pinout configuration.

The AD8223 is simple to use: one resistor sets the gain. With no external resistor, the AD8223 is configured for  $G = 5$ . With an external resistor, the AD8223 can be programmed for gains up to 1000.

The AD8223 has a wide input common-mode range and can amplify signals that have a 150 mV common-mode voltage below ground. Although the design of the AD8223 is optimized

to operate from a single supply, the AD8223 still provides excellent performance when operated from a dual voltage supply ( $\pm 2\text{ V}$  to  $\pm 12\text{ V}$ ).

Low power consumption (1.5 mW at 3 V), wide supply voltage range, and rail-to-rail output swing make the AD8223 ideal for battery-powered applications. The rail-to-rail output stage maximizes the dynamic range when operating from low supply voltages. The AD8223 replaces discrete instrumentation amplifier designs and offers superior linearity, temperature stability, and reliability in a minimum of space.

#### Rev. 0

Information furnished by Analog Devices is believed to be accurate and reliable. However, no responsibility is assumed by Analog Devices for its use, nor for any infringements of patents or other rights of third parties that may result from its use. Specifications subject to change without notice. No license is granted by implication or otherwise under any patent or patent rights of Analog Devices. Trademarks and registered trademarks are the property of their respective owners.

**TABLE OF CONTENTS**

Features .....	1	Gain Selection .....	14
Applications.....	1	Input Voltage Range.....	14
Connection Diagram .....	1	Reference Terminal .....	15
General Description .....	1	Input Protection .....	15
Revision History .....	2	RF Interference (RFI).....	15
Specifications.....	3	Ground Returns for Input Bias Currents .....	16
Single Supply .....	3	Applications Information .....	17
Dual Supply .....	5	Basic Connection .....	17
Absolute Maximum Ratings.....	7	Differential Output .....	17
Thermal Resistance .....	7	Output Buffering .....	17
ESD Caution.....	7	Cables.....	17
Pin Configuration and Function Descriptions.....	8	A Single-Supply Data Acquisition System .....	18
Typical Performance Characteristics .....	9	Amplifying Signals with Low Common-Mode Voltage.....	18
Theory of Operation .....	14	Outline Dimensions .....	19
Amplifier Architecture .....	14	Ordering Guide .....	20

**REVISION HISTORY****10/08—Revision 0: Initial Version**

# SPECIFICATIONS

## SINGLE SUPPLY

$T_A = 25^\circ\text{C}$ ,  $-V_S = 0\text{ V}$ ,  $+V_S = +5\text{ V}$ , and  $R_L = 10\text{ k}\Omega$  to  $2.5\text{ V}$ , unless otherwise noted.

Table 2

Parameter	Conditions	AD8223A			AD8223B			Unit
		Min	Typ	Max	Min	Typ	Max	
<b>COMMON-MODE REJECTION RATIO</b>								
DC to 60 Hz with 1 k $\Omega$ Source Imbalance	$V_{CM} = 0\text{ V to }3\text{ V}$							
G = 5		80			86			dB
G = 10		86			90			dB
G = 100		90			96			dB
G = 1000		90			96			dB
<b>NOISE</b>								
Voltage Noise, 1 kHz	$V_{IN+} = V_{IN-} = V_{REF} = 0\text{ V}$							
G = 5			50		50			nV/ $\sqrt{\text{Hz}}$
G = 1000			30		30			nV/ $\sqrt{\text{Hz}}$
RTI, 0.1 Hz to 10 Hz								
G = 5				1.0		1.0		$\mu\text{V p-p}$
G = 1000				0.6		0.6		$\mu\text{V p-p}$
Current Noise, 1 kHz			70		70		fA/ $\sqrt{\text{Hz}}$	
0.1 Hz to 10 Hz			1.2		1.2		pA p-p	
<b>VOLTAGE OFFSET</b>								
Total RTI error = $V_{OSI} + V_{OSO}/G$								
Input Offset, $V_{OSI}$	$T_A = -40^\circ\text{C to }+85^\circ\text{C}$			250			100	$\mu\text{V}$
Over Temperature				400			160	$\mu\text{V}$
Average TC		$T_A = -40^\circ\text{C to }+85^\circ\text{C}$		2			1	$\mu\text{V}/^\circ\text{C}$
Output Offset, $V_{OSO}$	$T_A = -40^\circ\text{C to }+85^\circ\text{C}$			1500			1000	$\mu\text{V}$
Over Temperature				2000			1500	$\mu\text{V}$
Average TC		$T_A = -40^\circ\text{C to }+85^\circ\text{C}$		15			10	$\mu\text{V}/^\circ\text{C}$
Offset Referred to Input vs. Supply (PSR)	$+V_S = 4\text{ V to }24\text{ V}$ , $-V_S = 0\text{ V}$							
G = 5		80			86			dB
G = 10		86			90			dB
G = 100		90			96			dB
G = 1000		90			96			dB
<b>INPUT CURRENT</b>								
Input Bias Current	$T_A = -40^\circ\text{C to }+85^\circ\text{C}$	5	12	25	5	12	25	nA
Over Temperature		5		28	5		28	nA
Average Temperature Coefficient		$T_A = -40^\circ\text{C to }+85^\circ\text{C}$		50			50	pA/ $^\circ\text{C}$
Input Offset Current	$T_A = -40^\circ\text{C to }+85^\circ\text{C}$		0.25	2		0.25	2	nA
Over Temperature				2.5			2.5	nA
Average Temperature Coefficient		$T_A = -40^\circ\text{C to }+85^\circ\text{C}$		5			5	pA/ $^\circ\text{C}$
<b>DYNAMIC RESPONSE</b>								
Small Signal -3 dB Bandwidth								
G = 5			125		125			kHz
G = 10			125		125			kHz
G = 100			50		50			kHz
G = 1000			5		5			kHz
Slew Rate			0.2		0.2		V/ $\mu\text{s}$	

# AD8223

Parameter	Conditions	AD8223A			AD8223B			Unit
		Min	Typ	Max	Min	Typ	Max	
Settling Time to 0.01%	Step size = 3.5 V							
G = 5			18			18		μs
G = 10			18			18		μs
G = 100			18			18		μs
G = 1000			85			85		μs
<b>GAIN</b>	$G = 5 + (80 \text{ k}\Omega/R_G)$							
Gain Range		5		1000	5		1000	V/V
Gain Error <sup>1</sup>	$V_{OUT} = 0.05 \text{ V to } 4.5 \text{ V}$							
G = 5				0.07			0.02	%
G = 10			0.10	0.3		0.10	0.2	%
G = 100			0.10	0.3		0.10	0.3	%
G = 1000			0.10	0.3		0.10	0.3	%
Nonlinearity	$V_{OUT} = 0.05 \text{ V to } 4.5 \text{ V}$							
G = 5			12			12		ppm
G = 1000			200			200		ppm
Gain vs. Temperature	$T_A = -40^\circ\text{C to } +85^\circ\text{C}$							
G = 5				10			2	ppm/°C
G > 5 <sup>1</sup>			50			50		ppm/°C
<b>INPUT</b>								
Input Impedance								
Differential			2  2			2  2		GΩ  pF
Common-Mode			2  2			2  2		GΩ  pF
Common-Mode Input Voltage Range <sup>2</sup>	$V_{IN+} = V_{IN-}$	$(-V_S) - 0.15$		$(+V_S) - 1.5$	$(-V_S) - 0.15$		$(+V_S) - 1.5$	V
<b>OUTPUT</b>								
Output Swing	$R_L = 10 \text{ k}\Omega \text{ to ground}$	+0.01		$(+V_S) - 0.5$	+0.01		$(+V_S) - 0.5$	V
	$R_L = 100 \text{ k}\Omega \text{ to ground}$	+0.01		$(+V_S) - 0.15$	+0.01		$(+V_S) - 0.15$	V
<b>REFERENCE INPUT</b>								
$R_{IN}$			60	±20%		60	±20%	kΩ
$I_{IN}$	$V_{IN+} = V_{IN-} = V_{REF} = 0 \text{ V}$		+10	+20		+10	+20	μA
Voltage Range		$-V_S$		$+V_S$	$-V_S$		$+V_S$	V
Gain to Output			$1 \pm 0.0002$			$1 \pm 0.0002$		V
<b>POWER SUPPLY</b>								
Operating Range		+3		+24	+3		+24	V
Quiescent Current			350	500		350	500	μA
Over Temperature	$T_A = -40^\circ\text{C to } +85^\circ\text{C}$			600			600	μA
<b>TEMPERATURE RANGE</b>								
For Specified Performance		-40		+85	-40		+85	°C

<sup>1</sup> Does not include effects of external resistor,  $R_G$ .

<sup>2</sup> Total input range depends on common-mode voltage, differential voltage, and gain. See Figure 18 through Figure 21, and the Input Voltage Range section in the Theory of Operation section for more information.

**DUAL SUPPLY**

$T_A = 25^\circ\text{C}$ ,  $-V_S = -12\text{ V}$ ,  $+V_S = +12\text{ V}$ , and  $R_L = 10\text{ k}\Omega$  to ground, unless otherwise noted.<sup>1</sup>

**Table 3.**

Parameter	Conditions	AD8223A			AD8223B			Unit
		Min	Typ	Max	Min	Typ	Max	
COMMON-MODE REJECTION RATIO								
DC to 60 Hz with 1 k $\Omega$ Source Imbalance	$V_{CM} = -10\text{ V to }10\text{ V}$							
G = 5		80			86			dB
G = 10		86			90			dB
G = 100		90			96			dB
G = 1000		90			96			dB
NOISE	$V_{IN+} = V_{IN-} = V_{REF} = 0\text{ V}$							
Voltage Noise, 1 kHz								
G = 5			50			50		nV/ $\sqrt{\text{Hz}}$
G = 1000			30			30		nV/ $\sqrt{\text{Hz}}$
RTI, 0.1 Hz to 10 Hz								
G = 5			1.0			1.0		$\mu\text{V p-p}$
G = 1000			0.6			0.6		$\mu\text{V p-p}$
Current Noise, 1 kHz								fA/ $\sqrt{\text{Hz}}$
0.1 Hz to 10 Hz			1.2			1.2		pA p-p
VOLTAGE OFFSET	Total RTI error = $V_{OSI} + V_{OSO}/G$							
Input Offset, $V_{OSI}$				250			100	$\mu\text{V}$
Over Temperature	$T_A = -40^\circ\text{C to }+85^\circ\text{C}$			400			160	$\mu\text{V}$
Average TC	$T_A = -40^\circ\text{C to }+85^\circ\text{C}$			2			1	$\mu\text{V}/^\circ\text{C}$
Output Offset, $V_{OSO}$				1500			1000	$\mu\text{V}$
Over Temperature	$T_A = -40^\circ\text{C to }+85^\circ\text{C}$			2000			1500	$\mu\text{V}$
Average TC	$T_A = -40^\circ\text{C to }+85^\circ\text{C}$			15			10	$\mu\text{V}/^\circ\text{C}$
Offset Referred to Input vs. Supply (PSR)	$+V_S = 5\text{ V to }12\text{ V}$ , $-V_S = -5\text{ V to }-12\text{ V}$							
G = 5		80			86			dB
G = 10		86			90			dB
G = 100		90			96			dB
G = 1000		90			96			dB
INPUT CURRENT								
Input Bias Current		5	12	25	5	12	25	nA
Over Temperature	$T_A = -40^\circ\text{C to }+85^\circ\text{C}$	5		28	5		28	nA
Average Temperature Coefficient	$T_A = -40^\circ\text{C to }+85^\circ\text{C}$		50			50		pA/ $^\circ\text{C}$
Input Offset Current			0.25	2		0.25	2	nA
Over Temperature	$T_A = -40^\circ\text{C to }+85^\circ\text{C}$			2.5			2.5	nA
Average Temperature Coefficient	$T_A = -40^\circ\text{C to }+85^\circ\text{C}$		5			5		pA/ $^\circ\text{C}$
DYNAMIC RESPONSE								
Small Signal -3 dB Bandwidth								
G = 5			200			200		kHz
G = 10			200			200		kHz
G = 100			70			70		kHz
G = 1000			7			7		kHz
Slew Rate			0.3			0.3		V/ $\mu\text{s}$
Settling Time to 0.01%	Step size = 10 V							
G = 5			30			30		$\mu\text{s}$
G = 10			30			30		$\mu\text{s}$
G = 100			30			30		$\mu\text{s}$
G = 1000			150			150		$\mu\text{s}$

# AD8223

Parameter	Conditions	AD8223A			AD8223B			Unit	
		Min	Typ	Max	Min	Typ	Max		
<b>GAIN</b>									
Gain Range	$G = 5 + (80 \text{ k}\Omega/R_G)$	5		1000	5		1000	V/V	
Gain Error <sup>2</sup>	$V_{OUT} = -10 \text{ V to } +10 \text{ V}$			0.07			0.02	%	
G = 5			0.10	0.3		0.10	0.2	%	
G = 100			0.10	0.3		0.10	0.3	%	
G = 1000			0.10	0.3		0.10	0.3	%	
Nonlinearity	$V_{OUT} = -10 \text{ V to } +10 \text{ V}$								
G = 5			5			5		ppm	
G = 1000			30			30		ppm	
Gain vs. Temperature	$T_A = -40^\circ\text{C to } +85^\circ\text{C}$								
G = 5				10			2	ppm/ $^\circ\text{C}$	
$G > 5^1$			50			50		ppm/ $^\circ\text{C}$	
<b>INPUT</b>									
Input Impedance									
Differential			2  2			2  2		$G\Omega  \text{pF}$	
Common-Mode			2  2			2  2		$G\Omega  \text{pF}$	
Common-Mode Input Voltage Range <sup>3</sup>	$V_{IN+} = V_{IN-}$	$(-V_S) - 0.15$		$(+V_S) - 1.5$	$(-V_S) - 0.15$		$(+V_S) - 1.5$	V	
<b>OUTPUT</b>									
Output Swing	$R_L = 10 \text{ k}\Omega$ to ground	$(-V_S) + 0.3$		$(+V_S) - 0.8$	$(-V_S) + 0.3$		$(+V_S) - 0.8$	V	
	$R_L = 100 \text{ k}\Omega$ to ground	$(-V_S) + 0.1$		$(+V_S) - 0.3$	$(-V_S) + 0.1$		$(+V_S) - 0.3$	V	
<b>REFERENCE INPUT</b>									
$R_{IN}$	$V_{IN+} = V_{IN-} = V_{REF} = 0 \text{ V}$		60	$\pm 20\%$		60	$\pm 20\%$	k $\Omega$	
$I_{IN}$			+10	+20		+10	+20	$\mu\text{A}$	
Voltage Range			$-V_S$		$+V_S$	$-V_S$		$+V_S$	V
Gain to Output				$1 \pm 0.0002$			$1 \pm 0.0002$		V
<b>POWER SUPPLY</b>									
Operating Range		$\pm 2$		$\pm 12$	$\pm 2$		$\pm 12$	V	
Quiescent Current				650			650	$\mu\text{A}$	
Over Temperature	$T_A = -40^\circ\text{C to } +85^\circ\text{C}$			850			850	$\mu\text{A}$	
<b>TEMPERATURE RANGE</b>									
For Specified Performance		-40		+85	-40		+85	$^\circ\text{C}$	

<sup>1</sup> Because maximum supply voltage is 24 V between the negative and positive supply, these specifications at  $\pm 12\text{V}$  are at the part's limit. Operation at a nominal supply voltage slightly less than  $\pm 12\text{V}$  is recommended to allow for power supply tolerances.

<sup>2</sup> Does not include effects of external resistor,  $R_G$ .

<sup>3</sup> Total input range depends on common-mode voltage, differential voltage, and gain. See Figure 18 through Figure 21 and the Input Voltage Range section in the Theory of Operation section for more information.

## ABSOLUTE MAXIMUM RATINGS

Table 4.

Parameter	Rating
Supply Voltage	±12 V
Internal Power Dissipation	650 mW
Differential Input Voltage	±V <sub>S</sub>
Output Short-Circuit Duration	Indefinite
Storage Temperature Range (R, RM)	−65°C to +125°C
Operating Temperature Range	−40°C to +85°C
Lead Temperature (Soldering, 10 sec)	300°C
ESD (Human Body Model)	1.5 kV
ESD (Charge Device Model)	500 V
ESD (Machine Model)	100 V

Stresses above those listed under Absolute Maximum Ratings may cause permanent damage to the device. This is a stress rating only; functional operation of the device at these or any other conditions above those indicated in the operational section of this specification is not implied. Exposure to absolute maximum rating conditions for extended periods may affect device reliability.

## THERMAL RESISTANCE

$\theta_{JA}$  is specified for the worst-case conditions, that is, a device soldered in a circuit board for surface-mount packages.

Specification is for the device in free air.

Table 5. Thermal Resistance

Package Type	$\theta_{JA}$	Unit
8-Lead SOIC (R)	155	°C/W
8-Lead MSOP (RM)	200	°C/W

## ESD CAUTION



**ESD (electrostatic discharge) sensitive device.** Charged devices and circuit boards can discharge without detection. Although this product features patented or proprietary protection circuitry, damage may occur on devices subjected to high energy ESD. Therefore, proper ESD precautions should be taken to avoid performance degradation or loss of functionality.

## PIN CONFIGURATION AND FUNCTION DESCRIPTIONS

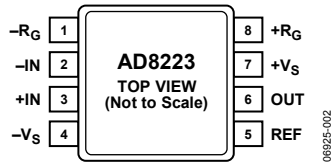

Figure 2. Pin Configuration

Table 6. Pin Function Descriptions

Pin No.	Mnemonic	Descriptions
1	-R <sub>G</sub>	Gain Resistor Terminal.
2	-IN	Negative Input.
3	+IN	Positive Input.
4	-V <sub>S</sub>	Negative Supply.
5	REF	Reference. Connect to a low impedance source. Output is referenced to this node.
6	OUT	Output.
7	+V <sub>S</sub>	Positive Supply.
8	+R <sub>G</sub>	Gain Resistor Terminal.



# TYPICAL PERFORMANCE CHARACTERISTICS

$T_A = 25^\circ\text{C}$ ,  $V_S = \pm 5\text{ V}$ ,  $R_L = 10\text{ k}\Omega$ , unless otherwise noted.

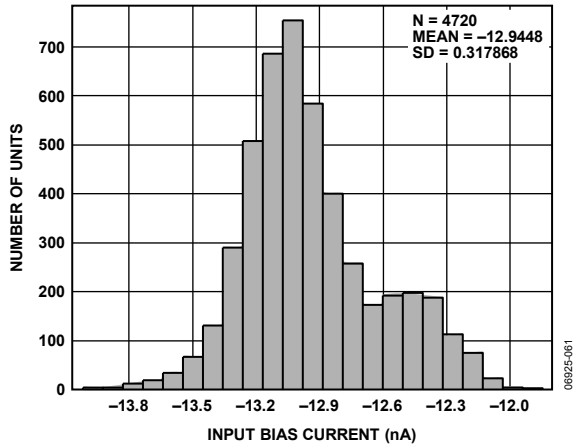

Figure 3. Typical Distribution of Input Bias Current

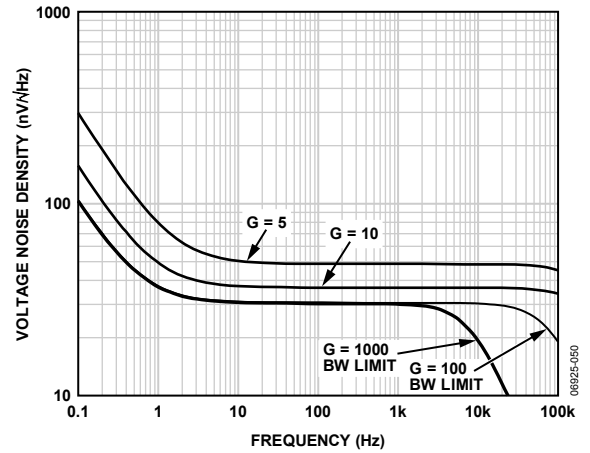

Figure 6. Voltage Noise Density vs. Frequency

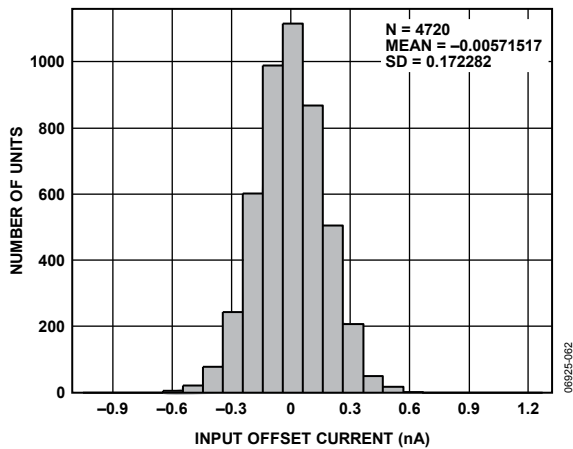

Figure 4. Typical Distribution of Input Offset Current

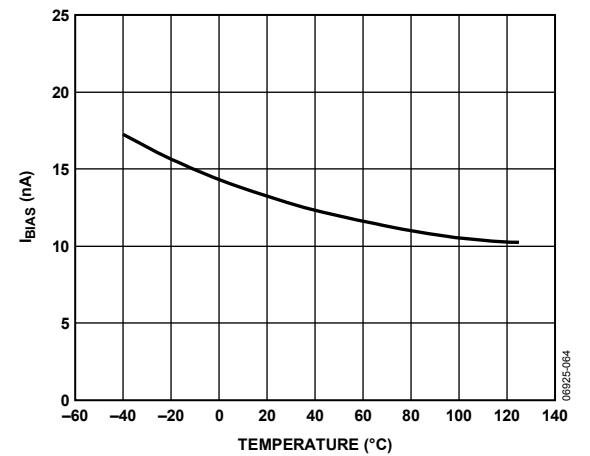

Figure 7.  $I_{BIAS}$  vs. Temperature

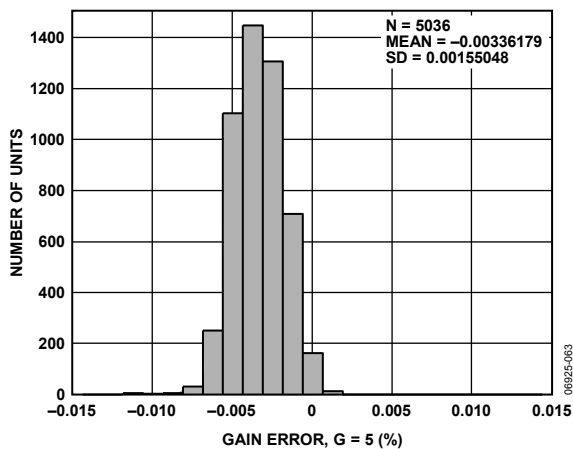

Figure 5. Typical Distribution for Gain Error ( $G = 5$ )

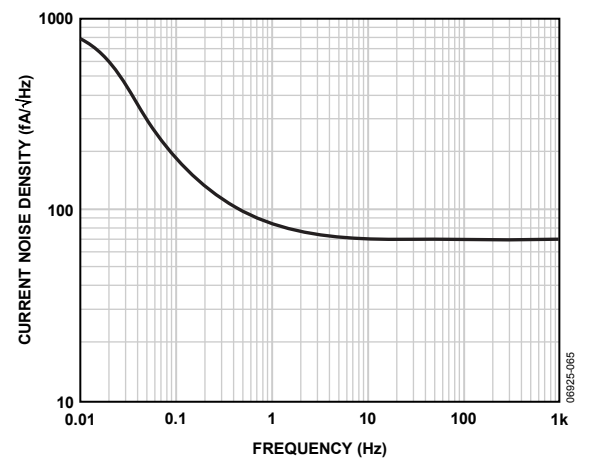

Figure 8. Current Noise Density vs. Frequency

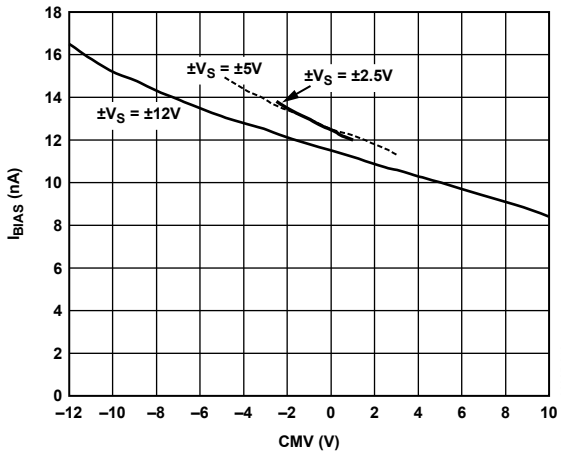

Figure 9.  $I_{BIAS}$  vs. CMV

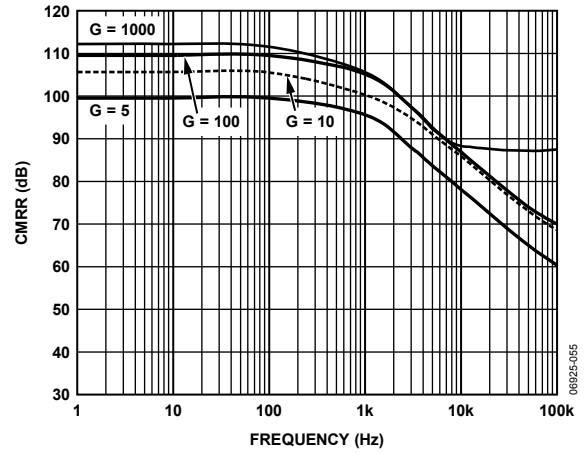

Figure 12. CMRR vs. Frequency,  $\pm V_S = \pm 12V$

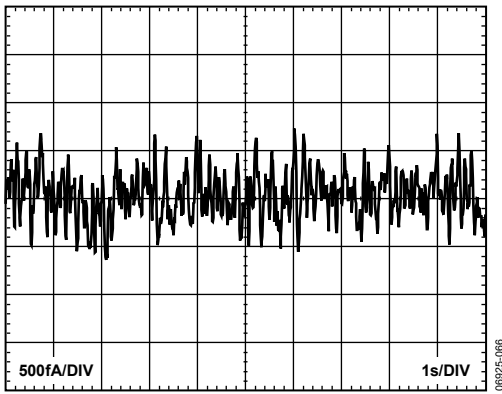

Figure 10. 0.1 Hz to 10 Hz Current Noise

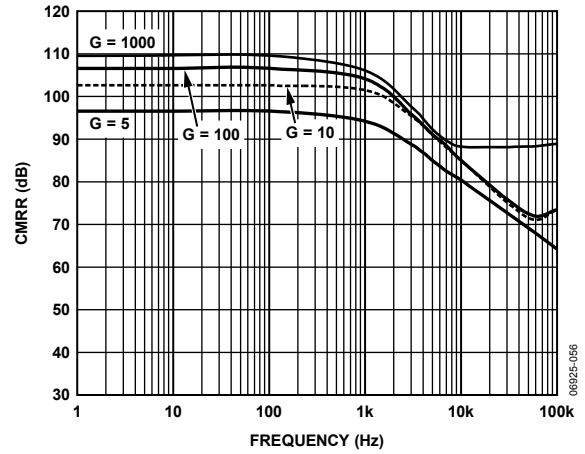

Figure 13. CMRR vs. Frequency,  $+V_S = +5V$

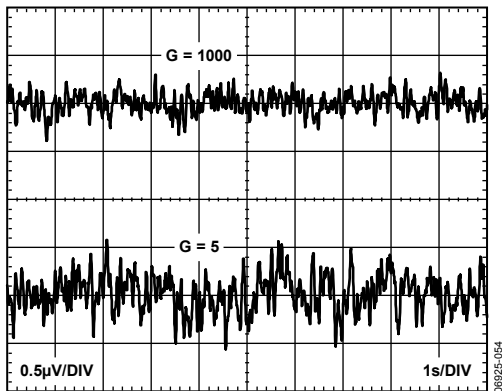

Figure 11. 0.1 Hz to 10 Hz RTI and RTO Voltage Noise

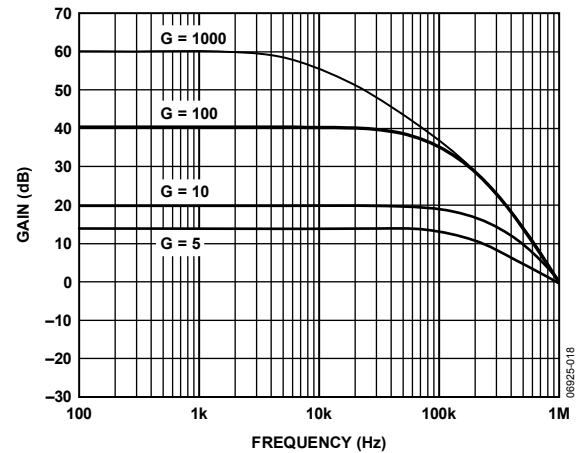

Figure 14. Gain vs. Frequency,  $\pm V_S = \pm 12V$

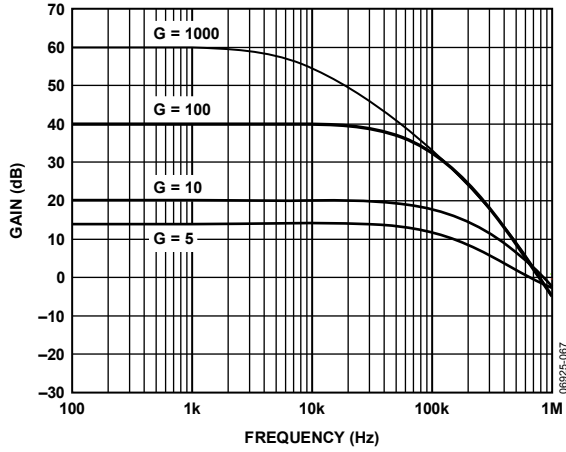

Figure 15. Gain vs. Frequency,  $+V_S = +5\text{ V}$

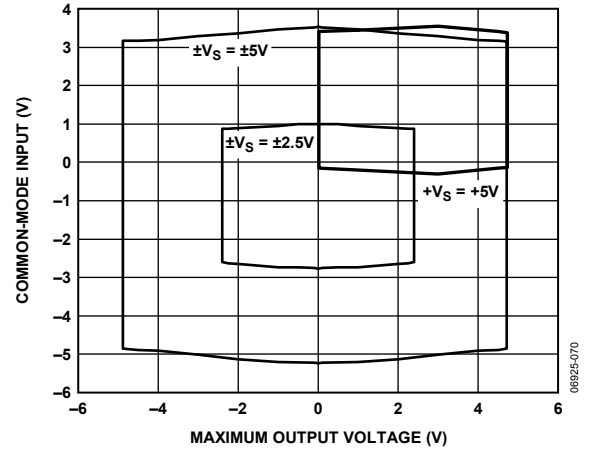

Figure 18. Common-Mode Input vs. Maximum Output Voltage,  $G = 5$ , Small Supplies

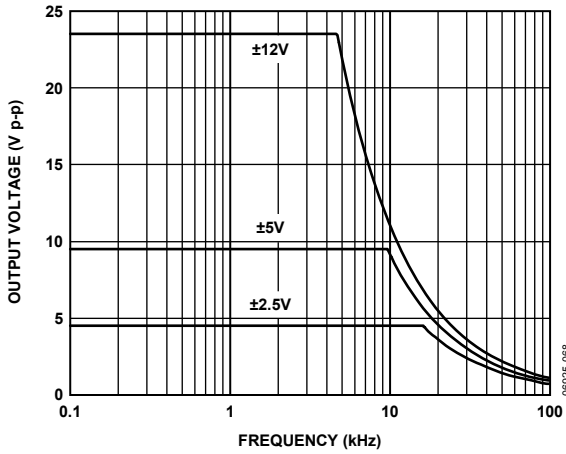

Figure 16. Large Signal Frequency Response

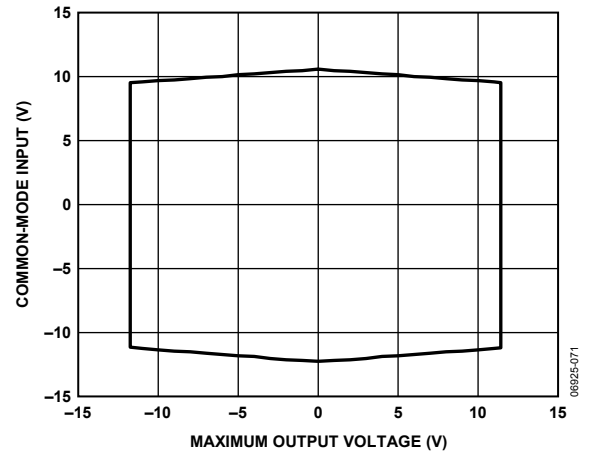

Figure 19. Common-Mode Input vs. Maximum Output Voltage,  $G = 5$ ,  $\pm V_S = \pm 12\text{ V}$

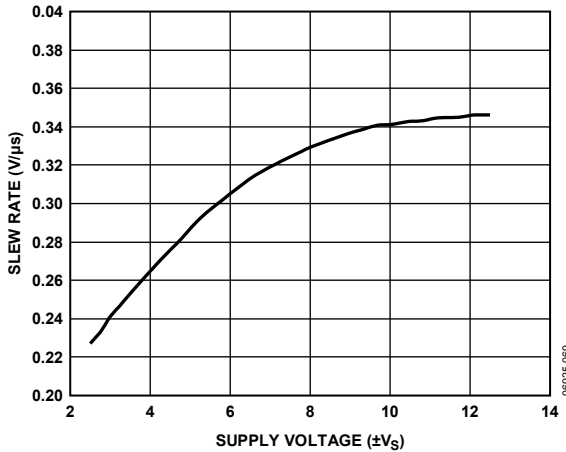

Figure 17. Slew Rate vs. Supply Voltage

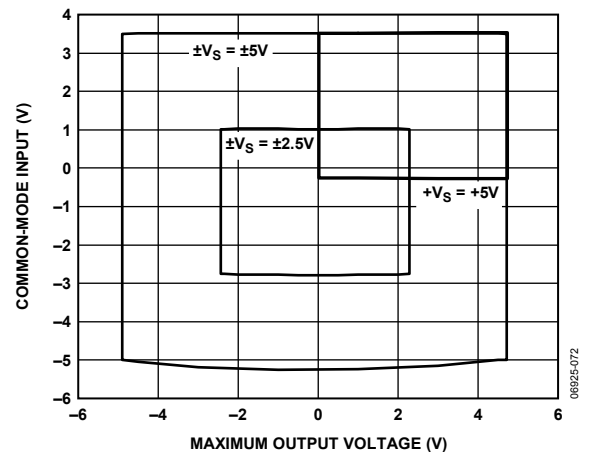

Figure 20. Common-Mode Input vs. Maximum Output Voltage,  $G = 100$ , Small Supplies

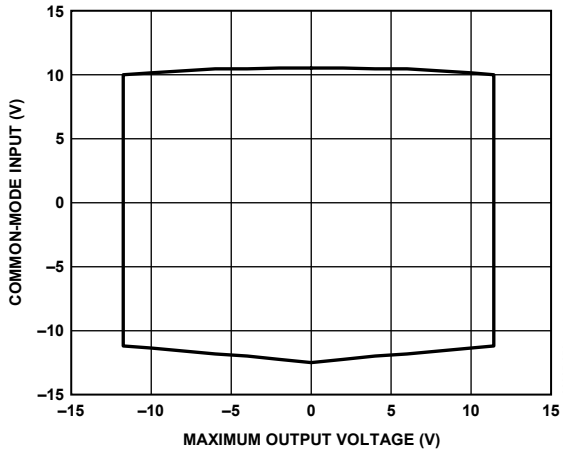

Figure 21. Common-Mode Input vs. Maximum Output Voltage,  $G = 100$ ,  $\pm V_S = \pm 12\text{ V}$

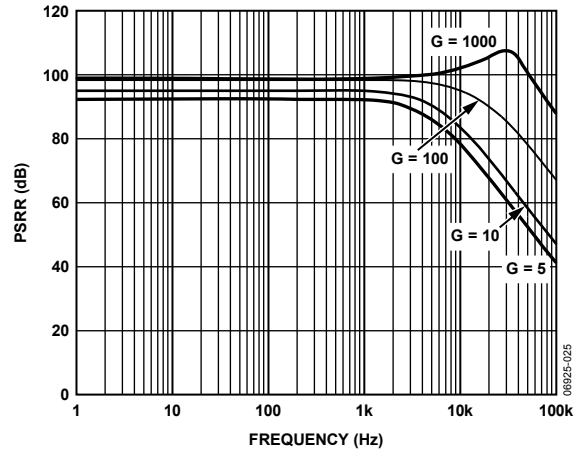

Figure 24. Negative PSRR vs. Frequency,  $\pm V_S = \pm 12\text{ V}$

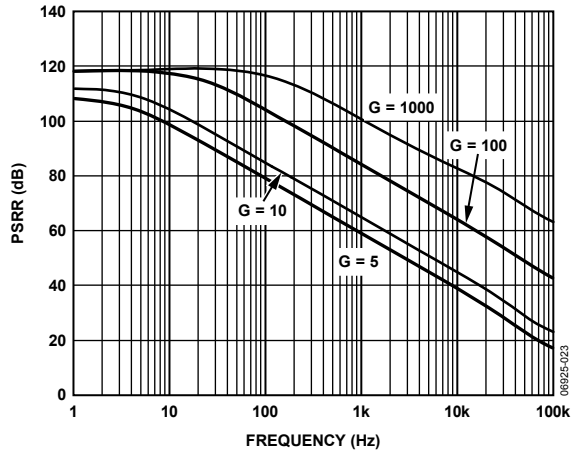

Figure 22. Positive PSRR vs. Frequency,  $\pm V_S = \pm 12\text{ V}$

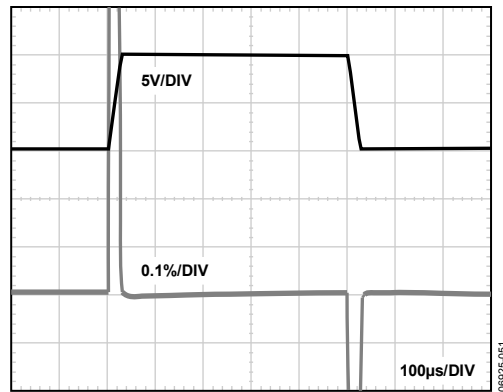

Figure 25. Large Signal Response,  $G = 5$

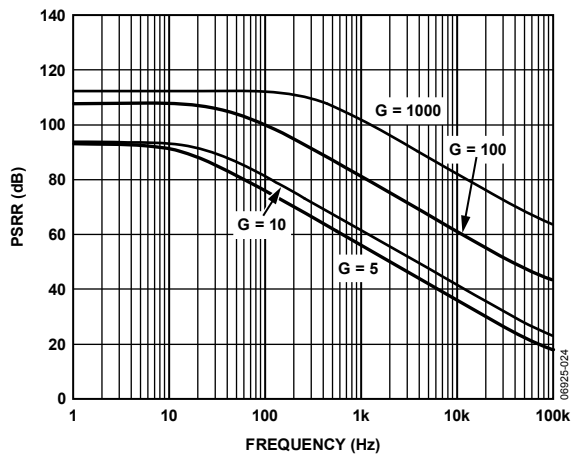

Figure 23. Positive PSRR vs. Frequency,  $+V_S = +5\text{ V}$

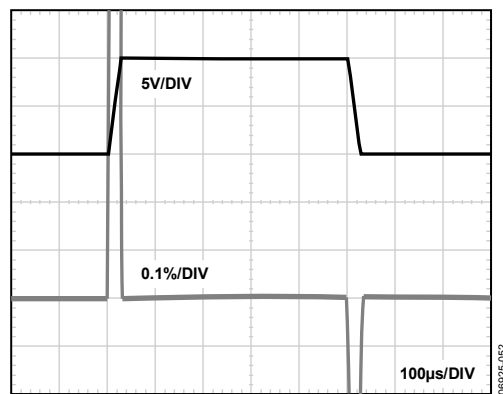

Figure 26. Large Signal Pulse Response,  $G = 100$ ,  $C_L = 100\text{ pF}$

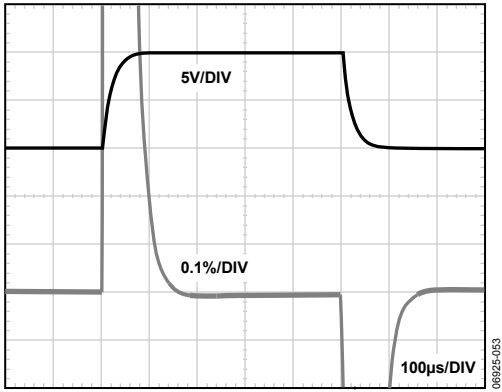

Figure 27. Large Signal Pulse Response,  $G = 1000$ ,  $C_L = 100$  pF

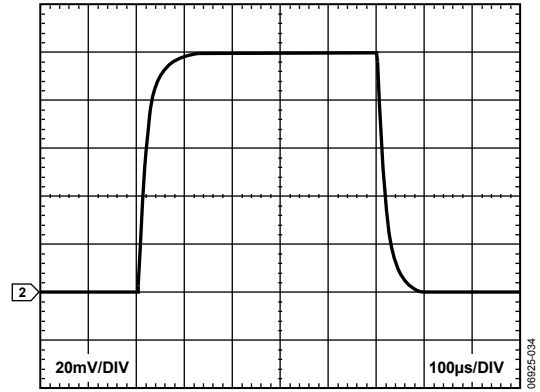

Figure 29. Small Signal Pulse Response,  $G = 1000$ ,  $R_L = 25$  k $\Omega$ ,  $C_L = 100$  pF

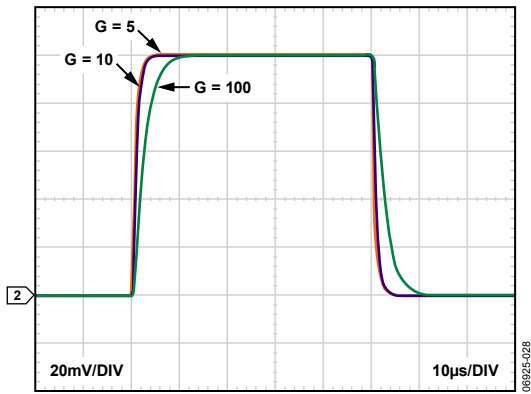

Figure 28. Small Signal Pulse Response,  $G = 5, 10, 100$ ;  $R_L = 10$  k $\Omega$

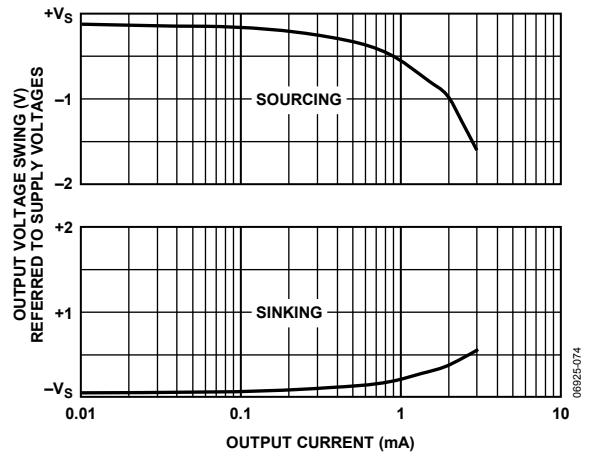

Figure 30. Output Voltage Swing vs. Output Current

## THEORY OF OPERATION

### AMPLIFIER ARCHITECTURE

The AD8223 is an instrumentation amplifier based on a classic 3-op amp approach, modified to ensure operation even at common-mode voltages at the negative supply rail. The architecture allows lower voltage offsets, better CMRR, and higher gain accuracy than competing instrumentation amplifiers in its class.

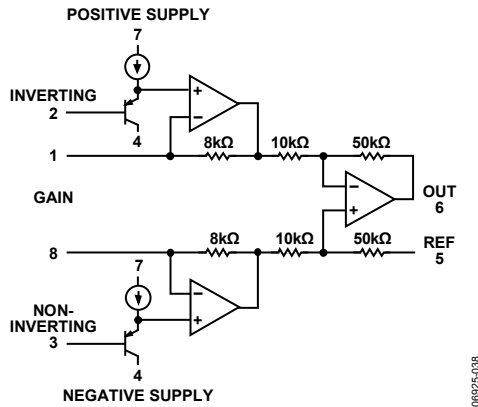

Figure 31. Simplified Schematic

Figure 31 shows a simplified schematic of the AD8223. The AD8223 has three stages. In the first stage, the input signal is applied to PNP transistors. These PNP transistors act as voltage buffers and allow input voltages below ground. The second stage consists of a pair of 8 kΩ resistors, the  $R_G$  resistor, and a pair of amplifiers. This stage allows the amplification of the AD8223 to be set with a single external resistor. The third stage is a differential amplifier composed of an op amp, two 10 kΩ resistors, and two 50 kΩ resistors. This stage removes the common-mode signal and applies an additional gain of 5.

The transfer function of the AD8223 is

$$V_{OUT} = G(V_{IN+} - V_{IN-}) + V_{REF}$$

where:

$$G = 5 + \frac{80 \text{ k}\Omega}{R_G}$$

### GAIN SELECTION

Placing a resistor across the  $R_G$  terminals sets the gain of the AD8223, which can be calculated by referring to Table 7 or by using the following gain equation:

$$R_G = \frac{80 \text{ k}\Omega}{G - 5}$$

Table 7. Gains Achieved Using 1% Resistors

1% Standard Table Value of $R_G$ ( $\Omega$ )	Desired Gain	Calculated Gain
26.7 k	8	7.99
15.8 k	10	10.1
5.36 k	20	19.9
2.26 k	40	40.4
1.78 k	50	49.9
845	100	99.7
412	200	199
162	500	499
80.6	1000	998

The AD8223 defaults to  $G = 5$  when no gain resistor is used. Add the tolerance and gain drift of the  $R_G$  resistor to the specifications of the AD8223 to determine the total gain accuracy of the system. When the gain resistor is not used, gain depends only on internal resistor matching, so gain error and gain drift are minimal.

### INPUT VOLTAGE RANGE

The 3-op amp architecture of the AD8223 applies gain and then removes the common-mode voltage. Therefore, internal nodes in the AD8223 experience a combination of both the gained signal and the common-mode signal. This combined signal can be limited by the voltage supplies even when the individual input and output signals are not. To determine whether the signal can be limited, refer to Figure 18 through Figure 21. Alternatively, use the parameters in the Specifications section to verify that the input and output are not limited and then use the following formula to make sure the internal nodes are not limited.

To check if it is limited by the internal nodes,

$$-V_S + 0.01 \text{ V} < 0.6 + V_{CM} \pm \frac{|V_{DIFF}| \times \text{Gain}}{10} < +V_S - 0.1 \text{ V}$$

If more common-mode range is required, a solution is to apply less gain in the instrumentation amplifier and more in a later stage.

## REFERENCE TERMINAL

The output voltage of the AD8223 is developed with respect to the potential on the reference terminal. This is useful when the output signal needs to be offset to a precise midsupply level. For example, a voltage source can be tied to the REF pin to level-shift the output so that the AD8223 can drive a single-supply ADC. The REF pin is protected with ESD diodes and should not exceed either  $+V_S$  or  $-V_S$  by more than 0.3 V.

For best performance, keep the source impedance to the REF terminal below  $5\ \Omega$ . As shown in Figure 31, the reference terminal, REF, is at one end of a  $50\ \text{k}\Omega$  resistor. Additional impedance at the REF terminal adds to this resistor and results in poorer CMRR performance.

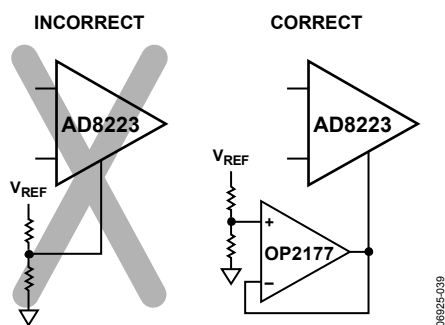

Figure 32. Driving the Reference Pin

## INPUT PROTECTION

Internal supply referenced clamping diodes allow the input, reference, output, and gain terminals of the AD8223 to safely withstand overvoltages of 0.3 V above or below the supplies. This is true for all gains, and for power-on and power-off. This last case is particularly important because the signal source and amplifier can be powered separately.

If the overvoltage is expected to exceed this value, limit the current through these diodes to about 10 mA using external current limiting resistors. This is shown in Figure 33. The size of this resistor is defined by the supply voltage and the required overvoltage protection.

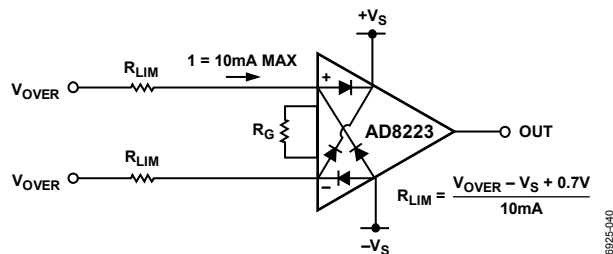

Figure 33. Input Protection

## RF INTERFERENCE (RFI)

RF rectification is often a problem when amplifiers are used in applications where there are strong RF signals. The disturbance can appear as a small dc offset voltage. High frequency signals can be filtered with a low-pass, R-C network placed at the input of the instrumentation amplifier, as shown in Figure 34. The filter limits the input signal bandwidth according to the following relationship:

$$FilterFreq_{Diff} = \frac{1}{2\pi R(2C_D + C_C)}$$

$$FilterFreq_{CM} = \frac{1}{2\pi RC_C}$$

where  $C_D \geq 10C_C$ .

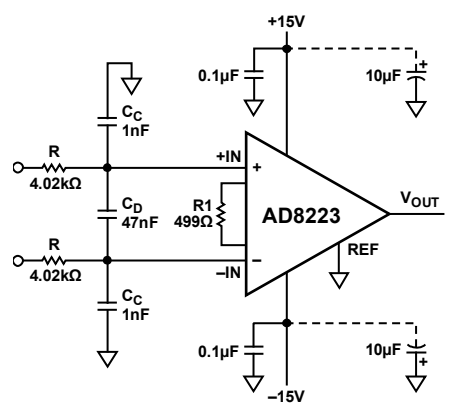

Figure 34. RFI Suppression

Figure 34 shows an example in which the differential filter frequency is approximately 400 Hz, and the common-mode filter frequency is approximately 40 kHz. The typical dc offset shift over frequency is less than  $1.5\ \mu\text{V}$ , and the RF signal rejection of the circuit is better than 71 dB.

The resistors were selected to be large enough to isolate the circuit input from the capacitors but not large enough to significantly increase the circuit noise. Choose values of R and  $C_C$  to minimize RFI. Mismatch between the  $R \times C_C$  at positive input and the  $R \times C_C$  at negative input degrades the CMRR of the AD8223. Because of their higher accuracy and stability, COG/NPO type ceramic capacitors are recommended for the  $C_C$  capacitors. The dielectric for the  $C_D$  capacitor is not as critical.

# AD8223

## GROUND RETURNS FOR INPUT BIAS CURRENTS

Input bias currents are those dc currents that must flow to bias the input transistors of an amplifier. These are usually transistor base currents. When amplifying floating input sources such as transformers or ac-coupled sources, there must be a direct dc path into each input so that the bias current can flow. Figure 35 shows how a bias current path can be provided for the cases of transformer coupling, capacitive ac-coupling, and a thermocouple application.

In dc-coupled resistive bridge applications, providing this path is generally not necessary because the bias current simply flows from the bridge supply through the bridge and into the amplifier. However, if the impedances that the two inputs see are large and differ by a large amount ( $>10\text{ k}\Omega$ ), the offset current of the input stage causes dc errors proportional to the input offset voltage of the amplifier.

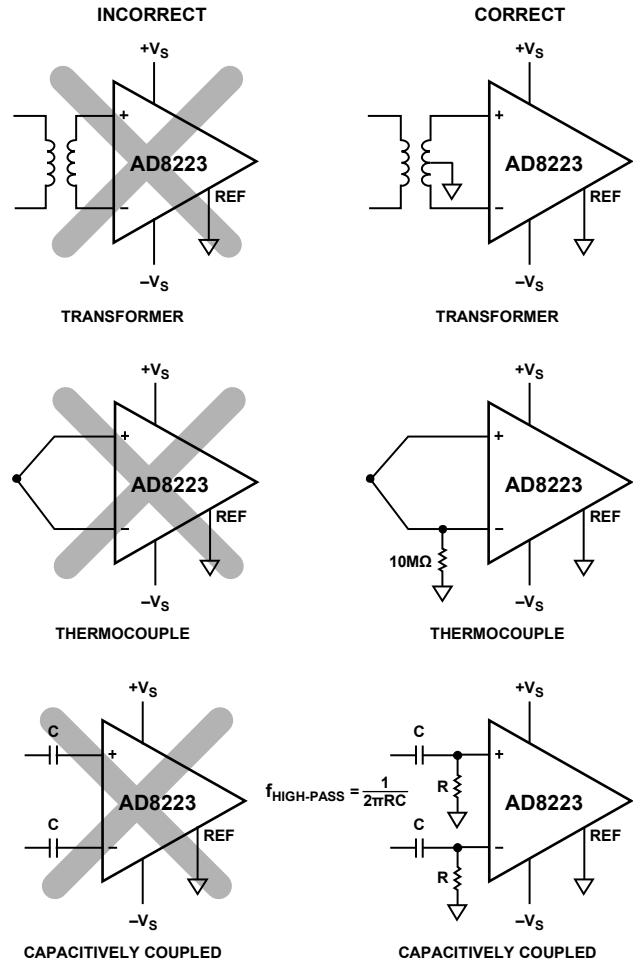
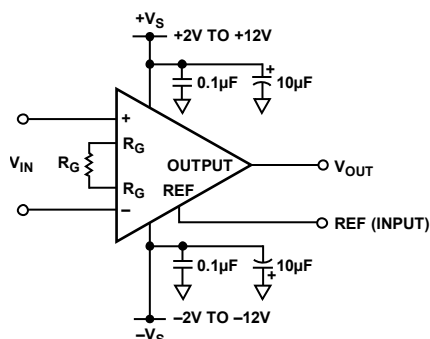

Figure 35. Creating an  $I_{\text{BIAS}}$  Path

06925-042



## APPLICATIONS INFORMATION



A. DUAL SUPPLY

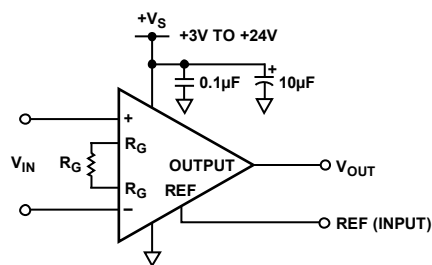

B. SINGLE SUPPLY

Figure 36. Basic Connections

06925-043

### BASIC CONNECTION

Figure 36 shows the basic connection circuit for the AD8223. The  $+V_S$  and  $-V_S$  terminals are connected to the power supply. The supply can be either bipolar ( $V_S = \pm 2\text{ V to } \pm 12\text{ V}$ ) or single supply ( $-V_S = 0\text{ V}$ ,  $+V_S = +3\text{ V to } +24\text{ V}$ ). Power supplies should be capacitively decoupled close to the power pins of the device. For best results, use surface-mount  $0.1\ \mu\text{F}$  ceramic chip capacitors and  $10\ \mu\text{F}$  electrolytic tantalum capacitors.

The input voltage, which can be either single-ended (tie either  $-IN$  or  $+IN$  to ground) or differential, is amplified by the programmed gain. The output signal appears as the voltage difference between the output pin and the externally applied voltage on the REF input.

### DIFFERENTIAL OUTPUT

Figure 37 shows how to create a differential output in-amp. An [OP1177](#) op amp creates the inverted output. Because the op amp drives the AD8223 reference pin, the AD8223 can still ensure that the differential voltage is correct. Errors from the op amp or mismatched resistors are common to both outputs and are thus common mode. These common-mode errors should be rejected by the next device in the signal chain.

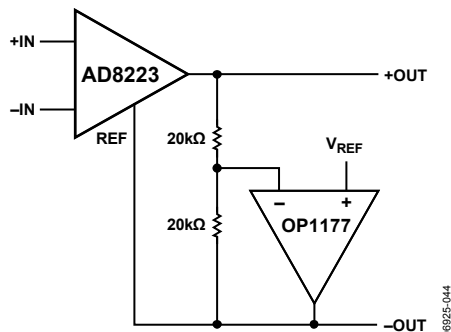

Figure 37. Differential Output Using Op Amp

06925-044

### OUTPUT BUFFERING

The AD8223 is designed to drive loads of  $10\text{ k}\Omega$  or greater. If the load is less than this value, buffer the AD8223 output with a precision single-supply op amp such as the [OP113](#). This op amp can swing from  $0\text{ V}$  to  $4\text{ V}$  on its output while driving a load as small as  $600\ \Omega$ .

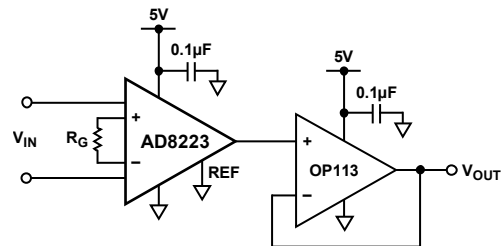

Figure 38. Output Buffering

06925-045

### CABLES

#### Receiving from a Cable

In many applications, shielded cables are used to minimize noise; for best CMR over frequency, the shield should be properly driven. Figure 39 shows an active guard drive that is configured to improve ac common-mode rejection by bootstrapping the capacitances of input cable shields, thus minimizing the capacitance mismatch between the inputs.

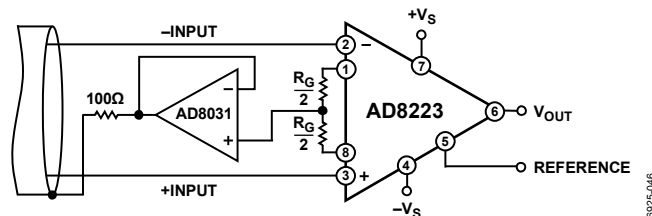

Figure 39. Common-Mode Shield Driver

06925-046

# AD8223

## Driving a Cable

All cables have a certain capacitance per unit length, which varies widely with cable type. The capacitive load from the cable may cause peaking in the output response of the AD8223. To reduce the peaking, use a resistor between the AD8223 and the cable. Because cable capacitance and desired output response vary widely, this resistor is best determined empirically. A good starting point is 75  $\Omega$ .

The AD8223 operates at a low enough frequency that transmission line effects are rarely an issue; therefore, the resistor need not match the characteristic impedance of the cable.

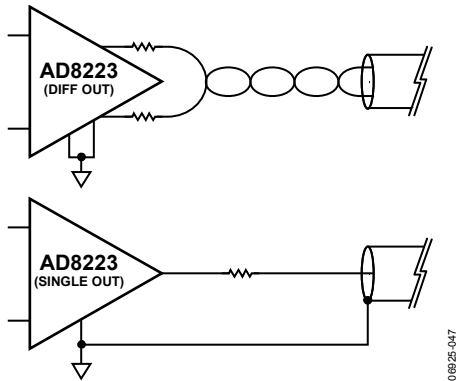

Figure 40. Driving a Cable

## A SINGLE-SUPPLY DATA ACQUISITION SYSTEM

Interfacing bipolar signals to single-supply analog-to-digital converters (ADCs) presents a challenge. The bipolar signal must be mapped into the input range of the ADC. Figure 41 shows how this translation can be achieved.

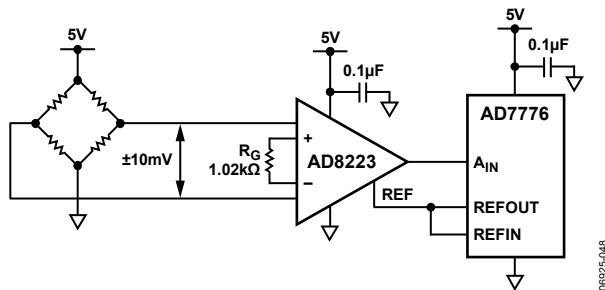

Figure 41. A Single-Supply Data Acquisition System

The bridge circuit is excited by a +5 V supply. The full-scale output voltage from the bridge ( $\pm 10$  mV), therefore, has a common-mode level of 2.5 V. The AD8223 removes the common-mode component and amplifies the input signal by a factor of 100 ( $R_G = 1.02$  k $\Omega$ ). This results in an output signal of  $\pm 1$  V. To prevent this signal from running into the AD8223 ground rail, the voltage on the REF pin must be raised to at least 1 V. In this example, the 2 V reference voltage from the AD7776 ADC is used to bias the AD8223 output voltage to 2 V  $\pm$  1 V, which corresponds to the input range of the ADC.

## AMPLIFYING SIGNALS WITH LOW COMMON-MODE VOLTAGE

Because the common-mode input range of the AD8223 extends 0.15 V below ground, it is possible to measure small differential signals that have low, or no, common-mode components. Figure 42 shows a thermocouple application in which one side of the J-type thermocouple is grounded.

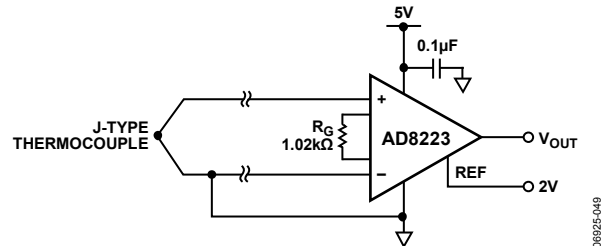
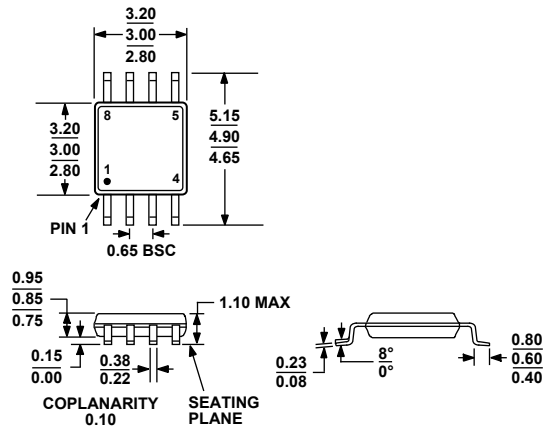

Figure 42. Amplifying Bipolar Signals with Low Common-Mode Voltage

Over a temperature range of  $-200^{\circ}\text{C}$  to  $+200^{\circ}\text{C}$ , the J-type thermocouple delivers a voltage ranging from  $-7.890$  mV to  $+10.777$  mV. A programmed gain on the AD8223 of 100 ( $R_G = 845$ ) and a voltage on the AD8223 REF pin of 2 V results in the AD8223 output voltage ranging from 1.110 V to 3.077 V relative to ground.

# OUTLINE DIMENSIONS



COMPLIANT TO JEDEC STANDARDS MO-187-AA

Figure 43. 8-Lead Mini Small Outline Package [MSOP] (RM-8)

Dimensions shown in millimeters

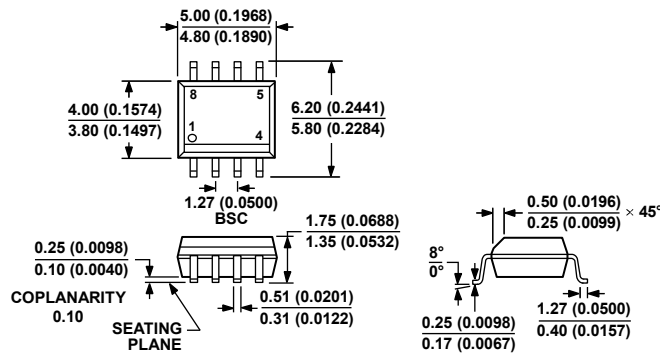

COMPLIANT TO JEDEC STANDARDS MS-012-AA

CONTROLLING DIMENSIONS ARE IN MILLIMETERS; INCH DIMENSIONS (IN PARENTHESES) ARE ROUNDED-OFF MILLIMETER EQUIVALENTS FOR REFERENCE ONLY AND ARE NOT APPROPRIATE FOR USE IN DESIGN.

Figure 44. 8-Lead Standard Small Outline Package [SOIC\_N] Narrow Body (R-8)

Dimensions shown in millimeters and (inches)

012407-A

# AD8223

## ORDERING GUIDE

Model	Temperature Range	Package Description	Package Option	Branding
AD8223AR	-40°C to +85°C	8-Lead SOIC_N	R-8	
AD8223AR-RL	-40°C to +85°C	8-Lead SOIC_N, 13" Tape and Reel	R-8	
AD8223AR-R7	-40°C to +85°C	8-Lead SOIC_N, 7" Tape and Reel	R-8	
AD8223ARM	-40°C to +85°C	8-Lead MSOP	RM-8	YOU
AD8223ARM-RL	-40°C to +85°C	8-Lead MSOP, 13" Tape and Reel	RM-8	YOU
AD8223ARM-R7	-40°C to +85°C	8-Lead MSOP, 7" Tape and Reel	RM-8	YOU
AD8223ARMZ <sup>1</sup>	-40°C to +85°C	8-Lead MSOP	RM-8	YOQ
AD8223ARMZ-RL <sup>1</sup>	-40°C to +85°C	8-Lead MSOP, 13" Tape and Reel	RM-8	YOQ
AD8223ARMZ-R7 <sup>1</sup>	-40°C to +85°C	8-Lead MSOP, 7" Tape and Reel	RM-8	YOQ
AD8223ARZ <sup>1</sup>	-40°C to +85°C	8-Lead SOIC_N	R-8	
AD8223ARZ-RL <sup>1</sup>	-40°C to +85°C	8-Lead SOIC_N, 13" Tape and Reel	R-8	
AD8223ARZ-R7 <sup>1</sup>	-40°C to +85°C	8-Lead SOIC_N, 7" Tape and Reel	R-8	
AD8223BR	-40°C to +85°C	8-Lead SOIC_N	R-8	
AD8223BR-RL	-40°C to +85°C	8-Lead SOIC_N, 13" Tape and Reel	R-8	
AD8223BR-R7	-40°C to +85°C	8-Lead SOIC_N, 7" Tape and Reel	R-8	
AD8223BRM	-40°C to +85°C	8-Lead MSOP	RM-8	YOV
AD8223BRM-RL	-40°C to +85°C	8-Lead MSOP, 13" Tape and Reel	RM-8	YOV
AD8223BRM-R7	-40°C to +85°C	8-Lead MSOP, 7" Tape and Reel	RM-8	YOV
AD8223BRMZ <sup>1</sup>	-40°C to +85°C	8-Lead MSOP	RM-8	YOR
AD8223BRMZ-RL <sup>1</sup>	-40°C to +85°C	8-Lead MSOP, 13" Tape and Reel	RM-8	YOR
AD8223BRMZ-R7 <sup>1</sup>	-40°C to +85°C	8-Lead MSOP, 7" Tape and Reel	RM-8	YOR
AD8223BRZ <sup>1</sup>	-40°C to +85°C	8-Lead SOIC_N	R-8	
AD8223BRZ-RL <sup>1</sup>	-40°C to +85°C	8-Lead SOIC_N, 13" Tape and Reel	R-8	
AD8223BRZ-R7 <sup>1</sup>	-40°C to +85°C	8-Lead SOIC_N, 7" Tape and Reel	R-8	

<sup>1</sup> Z = RoHS Compliant Part.

Компания «Life Electronics» занимается поставками электронных компонентов импортного и отечественного производства от производителей и со складов крупных дистрибьюторов Европы, Америки и Азии.

С конца 2013 года компания активно расширяет линейку поставок компонентов по направлению коаксиальный кабель, кварцевые генераторы и конденсаторы (керамические, пленочные, электролитические), за счёт заключения дистрибьюторских договоров

Мы предлагаем:

- Конкурентоспособные цены и скидки постоянным клиентам.
- Специальные условия для постоянных клиентов.
- Подбор аналогов.
- Поставку компонентов в любых объемах, удовлетворяющих вашим потребностям.
- Приемлемые сроки поставки, возможна ускоренная поставка.
- Доставку товара в любую точку России и стран СНГ.
- Комплексную поставку.
- Работу по проектам и поставку образцов.
- Формирование склада под заказчика.
- Сертификаты соответствия на поставляемую продукцию (по желанию клиента).
- Тестирование поставляемой продукции.
- Поставку компонентов, требующих военную и космическую приемку.
- Входной контроль качества.
- Наличие сертификата ISO.

В составе нашей компании организован Конструкторский отдел, призванный помогать разработчикам, и инженерам.

Конструкторский отдел помогает осуществить:

- Регистрацию проекта у производителя компонентов.
- Техническую поддержку проекта.
- Защиту от снятия компонента с производства.
- Оценку стоимости проекта по компонентам.
- Изготовление тестовой платы монтаж и пусконаладочные работы.



Тел: +7 (812) 336 43 04 (многоканальный)

Email: [org@lifeelectronics.ru](mailto:org@lifeelectronics.ru)