

ADA4851-1/ADA4851-2/ADA4851-4

FEATURES

Qualified for automotive applications

High speed

130 MHz, -3 dB bandwidth

375 V/ μ s slew rate

55 ns settling time to 0.1%

Excellent video specifications

0.1 dB flatness: 11 MHz

Differential gain: 0.08%

Differential phase: 0.09°

Fully specified at +3 V, +5 V, and ± 5 V supplies

Rail-to-rail output

Output swings to within 60 mV of either rail

Low voltage offset: 0.6 mV

Wide supply range: 2.7 V to 12 V

Low power: 2.5 mA per amplifier

Power-down mode

Available in space-saving packages

6-lead SOT-23, 8-lead MSOP, and 14-lead TSSOP

APPLICATIONS

Automotive infotainment systems

Automotive driver assistance systems

Consumer video

Professional video

Video switchers

Active filters

Clock buffers

GENERAL DESCRIPTION

The ADA4851-1 (single), ADA4851-2 (dual), and ADA4851-4 (quad) are low cost, high speed, voltage feedback rail-to-rail output op amps. Despite their low price, these parts provide excellent overall performance and versatility. The 130 MHz, -3 dB bandwidth and high slew rate make these amplifiers well suited for many general-purpose, high speed applications.

The ADA4851 family is designed to operate at supply voltages as low as +3 V and up to ± 5 V. These parts provide true single-supply capability, allowing input signals to extend 200 mV below the negative rail and to within 2.2 V of the positive rail. On the output, the amplifiers can swing within 60 mV of either supply rail.

With their combination of low price, excellent differential gain (0.08%), differential phase (0.09°), and 0.1 dB flatness out to 11 MHz, these amplifiers are ideal for consumer video applications.

The ADA4851-1W, ADA4851-2W, and ADA4851-4W are automotive grade versions, qualified for automotive applications.

Rev. J

Information furnished by Analog Devices is believed to be accurate and reliable. However, no responsibility is assumed by Analog Devices for its use, nor for any infringements of patents or other rights of third parties that may result from its use. Specifications subject to change without notice. No license is granted by implication or otherwise under any patent or patent rights of Analog Devices. Trademarks and registered trademarks are the property of their respective owners.

PIN CONFIGURATIONS

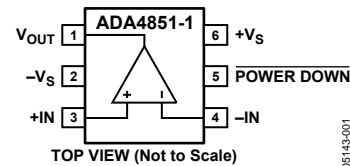

Figure 1. ADA4851-1, 6-Lead SOT-23 (RJ-6)

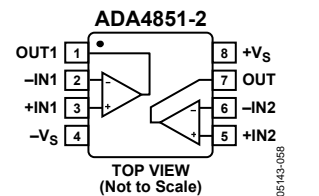

Figure 2. ADA4851-2, 8-Lead MSOP (RM-8)

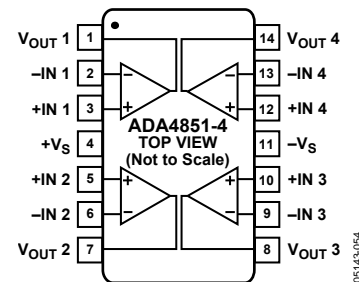

Figure 3. ADA4851-4, 14-Lead TSSOP (RU-14)

See the Automotive Products section for more details. The ADA4851 family is designed to work over the extended temperature range (-40°C to $+125^{\circ}\text{C}$).

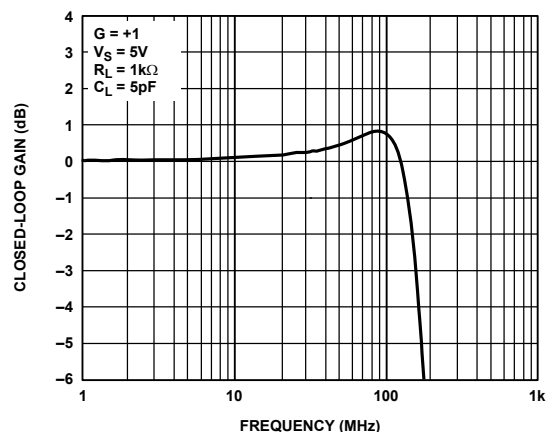

Figure 4. Small-Signal Frequency Response

TABLE OF CONTENTS

Features	1
Applications.....	1
Pin Configurations	1
General Description	1
Revision History	2
Specifications.....	4
Specifications with +3 V Supply.....	4
Specifications with +5 V Supply.....	6
Specifications with ±5 V Supply.....	8
Absolute Maximum Ratings.....	10
Thermal Resistance	10

REVISION HISTORY

10/10—Rev. I to Rev. J

Added Output Characteristics, Linear Output Current Parameter, Table 2.....	7
Added Output Characteristics, Linear Output Current Parameter, Table 3.....	9

5/10—Rev. H to Rev. I

Changes to Power-Down Bias Current Parameter, Table 1	3
Moved Automotive Products Section	20

4/10—Rev. G. to Rev. H

Added Automotive Product Information.....	Throughout
Changes to Table 1 Through Table 3.....	3
Updated Outline Dimensions	19
Changes to Ordering Guide	20

9/09—Rev. F. to Rev. G

Moved Automotive Products Section	18
Updated Outline Dimensions	19

5/09—Rev. E. to Rev. F

Changes to Features, Applications, and General Description Sections	1
Changes to Table 1.....	3
Changes to Table 2.....	5
Changes to Table 3.....	7
Changes to Figure 27 and Figure 28.....	13
Changes to Figure 47, Added Automotive Products Section ...	18
Updated Outline Dimensions	19
Changes to Ordering Guide	20

ESD Caution.....	10
Typical Performance Characteristics	11
Circuit Description.....	17
Headroom Considerations.....	17
Overload Behavior and Recovery	18
Single-Supply Video Amplifier	19
Video Reconstruction Filter.....	19
Outline Dimensions	20
Ordering Guide	21
Automotive Products.....	21

8/07—Rev. D to Rev. E

Changes to Applications.....	1
Changes to Common-Mode Rejection Ratio, Conditions.....	5
Changes to Headroom Considerations Section	13

4/06—Rev. C to Rev. D

Added Video Reconstruction Filter Section.....	15
--	----

5/05—Rev. B to Rev. C

Changes to General Description	1
Changes to Input Section	14

4/05—Rev. A to Rev. B

Added ADA4851-2, Added 8-Lead MSOP	Universal
Changes to Features	1
Changes to General Description	1
Changes to Table 1.....	3
Changes to Table 2.....	4
Changes to Table 3.....	5
Changes to Table 4 and Figure 5.....	6
Changes to Figure 12, Figure 15, and Figure 17	8
Changes to Figure 18.....	9
Changes to Figure 28 Caption	10
Changes to Figure 33.....	11
Changes to Figure 36 and Figure 38, Added Figure 39	12
Changes to Circuit Description Section	13
Changes to Headroom Considerations Section	13
Changes to Overload Behavior and Recovery Section	14
Added Single-Supply Video Amplifier Section	15
Updated Outline Dimensions	16
Changes to Ordering Guide	17

1/05—Rev. 0 to Rev. A

Added ADA4851-4 Universal
Added 14-Lead TSSOP..... Universal
Changes to Features 1
Changes to General Description 1
Changes to Figure 3..... 1
Changes to Specifications..... 3
Changes to Figure 4..... 6
Changes to Figure 8..... 7
Changes to Figure 11 8

Changes to Figure 22 9
Changes to Figure 23, Figure 24, and Figure 25..... 10
Changes to Figure 27 and Figure 28 10
Changes to Figure 29, Figure 30, and Figure 31..... 11
Changes to Figure 34 11
Added Figure 37 12
Changes to Ordering Guide..... 15
Updated Outline Dimensions..... 15

10/04—Revision 0: Initial Version

ADA4851-1/ADA4851-2/ADA4851-4

SPECIFICATIONS

SPECIFICATIONS WITH +3 V SUPPLY

$T_A = 25^\circ\text{C}$, $R_F = 0\ \Omega$ for $G = +1$, $R_F = 1\ \text{k}\Omega$ for $G > +1$, $R_L = 1\ \text{k}\Omega$, unless otherwise noted.

Table 1.

Parameter	Conditions/Comments	Min	Typ	Max	Unit
DYNAMIC PERFORMANCE					
–3 dB Bandwidth	$G = +1$, $V_{OUT} = 0.1\ \text{V p-p}$	104	130		MHz
	ADA4851-1W/2W/4W only: T_{MIN} to T_{MAX}	95			MHz
	$G = +1$, $V_{OUT} = 0.5\ \text{V p-p}$	80	105		MHz
	ADA4851-1W/2W/4W only: T_{MIN} to T_{MAX}	72			MHz
	$G = +2$, $V_{OUT} = 1\ \text{V p-p}$, $R_L = 150\ \Omega$		40		MHz
Bandwidth for 0.1 dB Flatness	$G = +2$, $V_{OUT} = 1\ \text{V p-p}$, $R_L = 150\ \Omega$		15		MHz
Slew Rate	$G = +2$, $V_{OUT} = 1\ \text{V step}$		100		V/ μs
Settling Time to 0.1%	$G = +2$, $V_{OUT} = 1\ \text{V step}$, $R_L = 150\ \Omega$		50		ns
NOISE/DISTORTION PERFORMANCE					
Harmonic Distortion, HD2/HD3	$f_C = 1\ \text{MHz}$, $V_{OUT} = 1\ \text{V p-p}$, $G = -1$		–73/–79		dBc
Input Voltage Noise	$f = 100\ \text{kHz}$		10		nV/ $\sqrt{\text{Hz}}$
Input Current Noise	$f = 100\ \text{kHz}$		2.5		pA/ $\sqrt{\text{Hz}}$
Differential Gain	$G = +3$, NTSC, $R_L = 150\ \Omega$, $V_{OUT} = 2\ \text{V p-p}$		0.44		%
Differential Phase	$G = +3$, NTSC, $R_L = 150\ \Omega$, $V_{OUT} = 2\ \text{V p-p}$		0.41		Degrees
Crosstalk (RTI)—ADA4851-2/ADA4851-4	$f = 5\ \text{MHz}$, $G = +2$, $V_{OUT} = 1.0\ \text{V p-p}$		–70/–60		dB
DC PERFORMANCE					
Input Offset Voltage			0.6	3.3	mV
	ADA4851-1W/2W/4W only: T_{MIN} to T_{MAX}			7.3	mV
Input Offset Voltage Drift			4		$\mu\text{V}/^\circ\text{C}$
Input Bias Current			2.3	4.0	μA
	ADA4851-1W/2W/4W only: T_{MIN} to T_{MAX}			5.0	μA
Input Bias Current Drift			6		nA/ $^\circ\text{C}$
Input Bias Offset Current			20		nA
Open-Loop Gain	$V_{OUT} = 0.25\ \text{V to } 0.75\ \text{V}$	80	105		dB
	ADA4851-1W/2W/4W only: T_{MIN} to T_{MAX}	78			dB
	ADA4851-1W only: T_{MIN} to T_{MAX}	75			
INPUT CHARACTERISTICS					
Input Resistance	Differential/common-mode		0.5/5.0		M Ω
Input Capacitance			1.2		pF
Input Common-Mode Voltage Range			–0.2 to +0.8		V
Input Overdrive Recovery Time (Rise/Fall)	$V_{IN} = +3.5\ \text{V}$, $-0.5\ \text{V}$, $G = +1$		60/60		ns
Common-Mode Rejection Ratio	$V_{CM} = 0\ \text{V to } 0.5\ \text{V}$	–81	–103		dB
	ADA4851-1W/2W/4W only: T_{MIN} to T_{MAX}	–65			dB
POWER-DOWN—ADA4851-1 ONLY					
Power-Down Input Voltage	Power-down		<1.1		V
	Power-up		>1.6		V
Turn-Off Time			0.7		μs
Turn-On Time			60		ns
Power-Down Bias Current	Enabled	$\overline{\text{POWER DOWN}} = 3\ \text{V}$	4	10	μA
		ADA4851-1W only: T_{MIN} to T_{MAX}		10	μA
Power-Down		$\overline{\text{POWER DOWN}} = 0\ \text{V}$	–14	–20	μA
		ADA4851-1W only: T_{MIN} to T_{MAX}		–20	μA

ADA4851-1/ADA4851-2/ADA4851-4

Parameter	Conditions/Comments	Min	Typ	Max	Unit
OUTPUT CHARACTERISTICS					
Output Overdrive Recovery Time (Rise/Fall)	$V_{IN} = +0.7\text{ V}, -0.1\text{ V}, G = +5$		70/100		ns
Output Voltage Swing		0.05 to 2.91	0.03 to 2.94		V
Short-Circuit Current	ADA4851-1W/2W/4W only: T_{MIN} to T_{MAX} Sinking/sourcing	0.06 to 2.89		90/70	V mA
POWER SUPPLY					
Operating Range		2.7		12	V
Quiescent Current per Amplifier			2.4	2.7	mA
Quiescent Current (Power-Down)	ADA4851-1W/2W/4W only: T_{MIN} to T_{MAX} POWER DOWN = low		0.2	2.7	mA
Positive Power Supply Rejection	ADA4851-1W only: T_{MIN} to T_{MAX} $+V_S = +2.5\text{ V to }+3.5\text{ V}, -V_S = -0.5\text{ V}$	-81	-100	0.3	dB
Negative Power Supply Rejection	ADA4851-1W/2W/4W only: T_{MIN} to T_{MAX} $+V_S = +2.5\text{ V}, -V_S = -0.5\text{ V to }-1.5\text{ V}$	-81	-100		dB
	ADA4851-1W/2W/4W only: T_{MIN} to T_{MAX}	-80			dB
		-80			dB

ADA4851-1/ADA4851-2/ADA4851-4

SPECIFICATIONS WITH +5 V SUPPLY

$T_A = 25^\circ\text{C}$, $R_F = 0\ \Omega$ for $G = +1$, $R_F = 1\ \text{k}\Omega$ for $G > +1$, $R_L = 1\ \text{k}\Omega$, unless otherwise noted.

Table 2.

Parameter	Conditions	Min	Typ	Max	Unit
DYNAMIC PERFORMANCE					
-3 dB Bandwidth	$G = +1$, $V_{OUT} = 0.1\ \text{V p-p}$	96	125		MHz
	ADA4851-1W/2W/4W only: T_{MIN} to T_{MAX}	90			MHz
	$G = +1$, $V_{OUT} = 0.5\ \text{V p-p}$	72	96		MHz
	ADA4851-1W/2W/4W only: T_{MIN} to T_{MAX}	64			MHz
	$G = +2$, $V_{OUT} = 1.4\ \text{V p-p}$, $R_L = 150\ \Omega$		35		MHz
Bandwidth for 0.1 dB Flatness	$G = +2$, $V_{OUT} = 1.4\ \text{V p-p}$, $R_L = 150\ \Omega$		11		MHz
Slew Rate	$G = +2$, $V_{OUT} = 2\ \text{V step}$		200		V/ μs
Settling Time to 0.1%	$G = +2$, $V_{OUT} = 2\ \text{V step}$, $R_L = 150\ \Omega$		55		ns
NOISE/DISTORTION PERFORMANCE					
Harmonic Distortion, HD2/HD3	$f_C = 1\ \text{MHz}$, $V_{OUT} = 2\ \text{V p-p}$, $G = +1$		-80/-100		dBc
Input Voltage Noise	$f = 100\ \text{kHz}$		10		nV/ $\sqrt{\text{Hz}}$
Input Current Noise	$f = 100\ \text{kHz}$		2.5		pA/ $\sqrt{\text{Hz}}$
Differential Gain	$G = +2$, NTSC, $R_L = 150\ \Omega$, $V_{OUT} = 2\ \text{V p-p}$		0.08		%
Differential Phase	$G = +2$, NTSC, $R_L = 150\ \Omega$, $V_{OUT} = 2\ \text{V p-p}$		0.11		Degrees
Crosstalk (RTI)—ADA4851-2/ADA4851-4	$f = 5\ \text{MHz}$, $G = +2$, $V_{OUT} = 2.0\ \text{V p-p}$		-70/-60		dB
DC PERFORMANCE					
Input Offset Voltage			0.6	3.4	mV
	ADA4851-1W/2W/4W only: T_{MIN} to T_{MAX}			7.4	mV
Input Offset Voltage Drift			4		$\mu\text{V}/^\circ\text{C}$
Input Bias Current			2.2	3.9	μA
	ADA4851-1W/2W/4W only: T_{MIN} to T_{MAX}			4.9	μA
Input Bias Current Drift			6		nA/ $^\circ\text{C}$
Input Bias Offset Current			20		nA
Open-Loop Gain	$V_{OUT} = 1\ \text{V to } 4\ \text{V}$	97	107		dB
	ADA4851-1W/2W/4W only: T_{MIN} to T_{MAX}	90			dB
INPUT CHARACTERISTICS					
Input Resistance	Differential/common-mode		0.5/5.0		M Ω
Input Capacitance			1.2		pF
Input Common-Mode Voltage Range			-0.2 to +2.8		V
Input Overdrive Recovery Time (Rise/Fall)	$V_{IN} = +5.5\ \text{V}$, $-0.5\ \text{V}$, $G = +1$		50/45		ns
Common-Mode Rejection Ratio	$V_{CM} = 0\ \text{V to } 2\ \text{V}$	-86	-105		dB
	ADA4851-1W/2W/4W only: T_{MIN} to T_{MAX}	-80			dB
POWER-DOWN—ADA4851-1 ONLY					
Power-Down Input Voltage	Power-down		<1.1		V
	Power-up		>1.6		V
Turn-Off Time			0.7		μs
Turn-On Time			50		ns
Power-Down Bias Current	Enabled	$\overline{\text{POWER DOWN}} = 5\ \text{V}$	33	40	μA
		ADA4851-1W only: T_{MIN} to T_{MAX}		40	μA
Power-Down	Power-Down	$\overline{\text{POWER DOWN}} = 0\ \text{V}$	-22	-30	μA
		ADA4851-1W only: T_{MIN} to T_{MAX}		-30	μA

ADA4851-1/ADA4851-2/ADA4851-4

Parameter	Conditions	Min	Typ	Max	Unit
OUTPUT CHARACTERISTICS					
Output Overdrive Recovery Time (Rise/Fall)	$V_{IN} = +1.1\text{ V}, -0.1\text{ V}, G = +5$		60/70		ns
Output Voltage Swing		0.09 to 4.91	0.06 to 4.94		V
Linear Output Current	ADA4851-1W/2W/4W only: T_{MIN} to T_{MAX}	0.11 to 4.89			V
Short-Circuit Current	1% THD with 1 MHz, $V_{OUT} = 2\text{ V p-p}$ Sinking/sourcing		66		mA
			110/90		mA
POWER SUPPLY					
Operating Range		2.7		12	V
Quiescent Current per Amplifier			2.5	2.8	mA
Quiescent Current (Power-Down)	ADA4851-1W/2W/4W only: T_{MIN} to T_{MAX} POWER DOWN = low		0.2	2.8	mA
Positive Power Supply Rejection	ADA4851-1W only: T_{MIN} to T_{MAX} $+V_S = +5\text{ V to }+6\text{ V}, -V_S = 0\text{ V}$	-82	-101	0.3	dB
Negative Power Supply Rejection	ADA4851-1W/2W/4W only: T_{MIN} to T_{MAX} $+V_S = +5\text{ V}, -V_S = -0\text{ V to }-1\text{ V}$	-82			dB
	ADA4851-1W/2W/4W only: T_{MIN} to T_{MAX}	-81	-101		dB
		-81			dB

ADA4851-1/ADA4851-2/ADA4851-4

SPECIFICATIONS WITH ± 5 V SUPPLY

$T_A = 25^\circ\text{C}$, $R_F = 0\ \Omega$ for $G = +1$, $R_F = 1\ \text{k}\Omega$ for $G > +1$, $R_L = 1\ \text{k}\Omega$, unless otherwise noted.

Table 3.

Parameter	Conditions	Min	Typ	Max	Unit
DYNAMIC PERFORMANCE					
–3 dB Bandwidth	$G = +1, V_{OUT} = 0.1\ \text{V p-p}$	83	105		MHz
	ADA4851-1W/2W/4W only: T_{MIN} to T_{MAX}	75			MHz
	$G = +1, V_{OUT} = 1\ \text{V p-p}$	52	74		MHz
	ADA4851-1W/2W/4W only: T_{MIN} to T_{MAX}	42			MHz
	$G = +2, V_{OUT} = 2\ \text{V p-p}, R_L = 150\ \Omega$		40		MHz
Bandwidth for 0.1 dB Flatness	$G = +2, V_{OUT} = 2\ \text{V p-p}, R_L = 150\ \Omega$		11		MHz
Slew Rate	$G = +2, V_{OUT} = 7\ \text{V step}$		375		V/ μs
Settling Time to 0.1%	$G = +2, V_{OUT} = 2\ \text{V step}$		190		V/ μs
	$G = +2, V_{OUT} = 2\ \text{V step}, R_L = 150\ \Omega$		55		ns
NOISE/DISTORTION PERFORMANCE					
Harmonic Distortion, HD2/HD3	$f_c = 1\ \text{MHz}, V_{OUT} = 2\ \text{V p-p}, G = +1$		–83/–107		dBc
Input Voltage Noise	$f = 100\ \text{kHz}$		10		nV/ $\sqrt{\text{Hz}}$
Input Current Noise	$f = 100\ \text{kHz}$		2.5		pA/ $\sqrt{\text{Hz}}$
Differential Gain	$G = +2, \text{NTSC}, R_L = 150\ \Omega, V_{OUT} = 2\ \text{V p-p}$		0.08		%
Differential Phase	$G = +2, \text{NTSC}, R_L = 150\ \Omega, V_{OUT} = 2\ \text{V p-p}$		0.09		Degrees
Crosstalk (RTI)—ADA4851-2/ADA4851-4	$f = 5\ \text{MHz}, G = +2, V_{OUT} = 2.0\ \text{V p-p}$		–70/–60		dB
DC PERFORMANCE					
Input Offset Voltage			0.6	3.5	mV
	ADA4851-1W/2W/4W only: T_{MIN} to T_{MAX}			7.5	mV
Input Offset Voltage Drift			4		$\mu\text{V}/^\circ\text{C}$
Input Bias Current			2.2	4.0	μA
	ADA4851-1W/2W/4W only: T_{MIN} to T_{MAX}			4.5	μA
Input Bias Current Drift			6		nA/ $^\circ\text{C}$
Input Bias Offset Current			20		nA
Open-Loop Gain	$V_{OUT} = \pm 2.5\ \text{V}$	99	106		dB
	ADA4851-1W/2W/4W only: T_{MIN} to T_{MAX}	90			dB
INPUT CHARACTERISTICS					
Input Resistance	Differential/common-mode		0.5/5.0		M Ω
Input Capacitance			1.2		pF
Input Common-Mode Voltage Range			–5.2 to +2.8		V
Input Overdrive Recovery Time (Rise/Fall)	$V_{IN} = \pm 6\ \text{V}, G = +1$		50/25		ns
Common-Mode Rejection Ratio	$V_{CM} = 0\ \text{V to } -4\ \text{V}$	–90	–105		dB
	ADA4851-1W/2W/4W only: T_{MIN} to T_{MAX}	–86			dB
POWER-DOWN—ADA4851-1 ONLY					
Power-Down Input Voltage	Power-down		< –3.9		V
	Power-up		> –3.4		V
Turn-Off Time			0.7		μs
Turn-On Time			30		ns
Power-Down Bias Current	Enabled		100	130	μA
	ADA4851-1W only: T_{MIN} to T_{MAX}			130	μA
Power-Down	POWER DOWN = +5 V		–50	–60	μA
	ADA4851-1W only: T_{MIN} to T_{MAX}			–60	μA

ADA4851-1/ADA4851-2/ADA4851-4

Parameter	Conditions	Min	Typ	Max	Unit
OUTPUT CHARACTERISTICS					
Output Overdrive Recovery Time (Rise/Fall)	$V_{IN} = \pm 1.2\text{ V}$, $G = +5$		80/50		ns
Output Voltage Swing		-4.87 to +4.88	-4.92 to +4.92		V
Linear Output Current	ADA4851-1W/2W/4W only: T_{MIN} to T_{MAX}	-4.85 to +4.85			V
Short-Circuit Current	1% THD with 1 MHz, $V_{OUT} = 2\text{ V p-p}$ Sinking/sourcing		83 125/110		mA mA
POWER SUPPLY					
Operating Range		2.7		12	V
Quiescent Current per Amplifier			2.9	3.2	mA
Quiescent Current (Power-Down)	ADA4851-1W/2W/4W only: T_{MIN} to T_{MAX} POWER DOWN = low		0.2	3.2	mA
Positive Power Supply Rejection	ADA4851-1W only: T_{MIN} to T_{MAX} $+V_S = +5\text{ V}$ to $+6\text{ V}$, $-V_S = -5\text{ V}$	-82	-101	0.325	dB
Negative Power Supply Rejection	ADA4851-1W/2W/4W only: T_{MIN} to T_{MAX} $+V_S = +5\text{ V}$, $-V_S = -5\text{ V}$ to -6 V	-82	-102	0.325	dB
	ADA4851-1W/2W/4W only: T_{MIN} to T_{MAX}	-81			dB

ABSOLUTE MAXIMUM RATINGS

Table 4.

Parameter	Rating
Supply Voltage	12.6 V
Power Dissipation	See Figure 5
Common-Mode Input Voltage	-V _S - 0.5 V to +V _S + 0.5 V
Differential Input Voltage	+V _S to -V _S
Storage Temperature Range	-65°C to +125°C
Operating Temperature Range	-40°C to +125°C
Lead Temperature	JEDEC J-STD-20
Junction Temperature	150°C

Stresses above those listed under Absolute Maximum Ratings may cause permanent damage to the device. This is a stress rating only; functional operation of the device at these or any other conditions above those indicated in the operational section of this specification is not implied. Exposure to absolute maximum rating conditions for extended periods may affect device reliability.

THERMAL RESISTANCE

θ_{JA} is specified for the worst-case conditions; that is, θ_{JA} is specified for device soldered in circuit board for surface-mount packages.

Table 5. Thermal Resistance

Package Type	θ _{JA}	Unit
6-lead SOT-23	170	°C/W
8-lead MSOP	150	°C/W
14-lead TSSOP	120	°C/W

Maximum Power Dissipation

The maximum safe power dissipation for the ADA4851-1/ADA4851-2/ADA4851-4 is limited by the associated rise in junction temperature (T_J) on the die. At approximately 150°C, which is the glass transition temperature, the plastic changes its properties. Even temporarily exceeding this temperature limit may change the stresses that the package exerts on the die, permanently shifting the parametric performance of the amplifiers. Exceeding a junction temperature of 150°C for an extended period can result in changes in silicon devices, potentially causing degradation or loss of functionality.

The power dissipated in the package (P_D) is the sum of the quiescent power dissipation and the power dissipated in the die due to the drive of the amplifier at the output. The quiescent power is the voltage between the supply pins (V_S) times the quiescent current (I_S).

$$P_D = \text{Quiescent Power} + (\text{Total Drive Power} - \text{Load Power})$$

$$P_D = (V_S \times I_S) + \left(\frac{V_S}{2} \times \frac{V_{OUT}}{R_L} \right) - \frac{V_{OUT}^2}{R_L}$$

RMS output voltages should be considered. If R_L is referenced to -V_S, as in single-supply operation, the total drive power is V_S × I_{OUT}. If the rms signal levels are indeterminate, consider the worst case, when V_{OUT} = V_S/4 for R_L to midsupply.

$$P_D = (V_S \times I_S) + \frac{(V_S/4)^2}{R_L}$$

In single-supply operation with R_L referenced to -V_S, the worst case is V_{OUT} = V_S/2.

Airflow increases heat dissipation, effectively reducing θ_{JA}. In addition, more metal directly in contact with the package leads and through holes under the device reduces θ_{JA}.

Figure 5 shows the maximum safe power dissipation in the package vs. the ambient temperature for the 6-lead SOT-23 (170°C/W), the 8-lead MSOP (150°C/W), and the 14-lead TSSOP (120°C/W) on a JEDEC standard 4-layer board. θ_{JA} values are approximations.

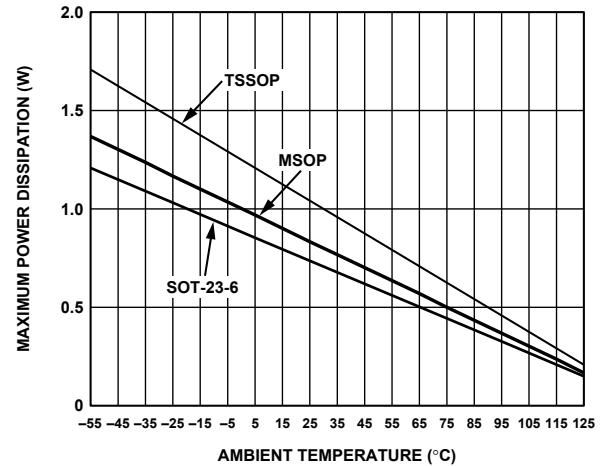

Figure 5. Maximum Power Dissipation vs. Temperature for a 4-Layer Board

ESD CAUTION



ESD (electrostatic discharge) sensitive device. Charged devices and circuit boards can discharge without detection. Although this product features patented or proprietary protection circuitry, damage may occur on devices subjected to high energy ESD. Therefore, proper ESD precautions should be taken to avoid performance degradation or loss of functionality.

TYPICAL PERFORMANCE CHARACTERISTICS

$T_A = 25^\circ\text{C}$, $R_F = 0\ \Omega$ for $G = +1$, $R_F = 1\ \text{k}\Omega$ for $G > +1$, $R_L = 1\ \text{k}\Omega$, unless otherwise noted.

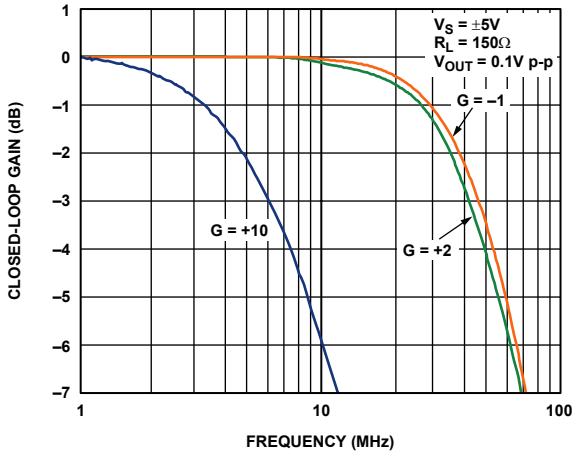

Figure 6. Small-Signal Frequency Response for Various Gains

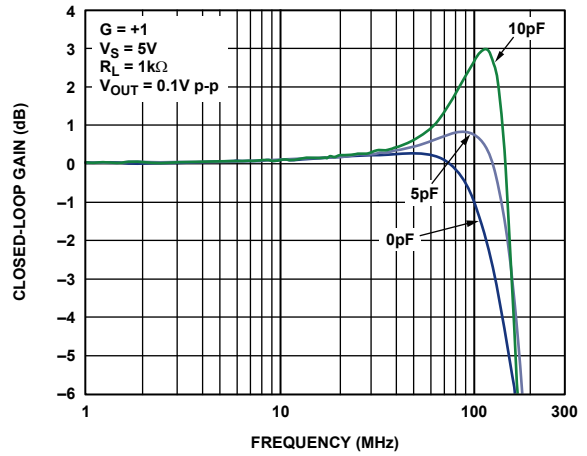

Figure 9. Small-Signal Frequency Response for Various Capacitive Loads

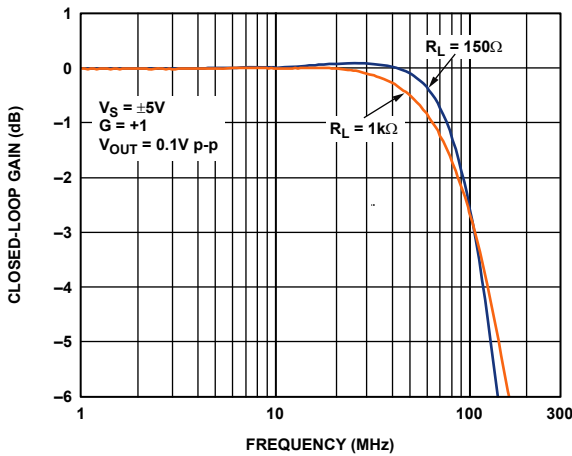

Figure 7. Small-Signal Frequency Response for Various Loads

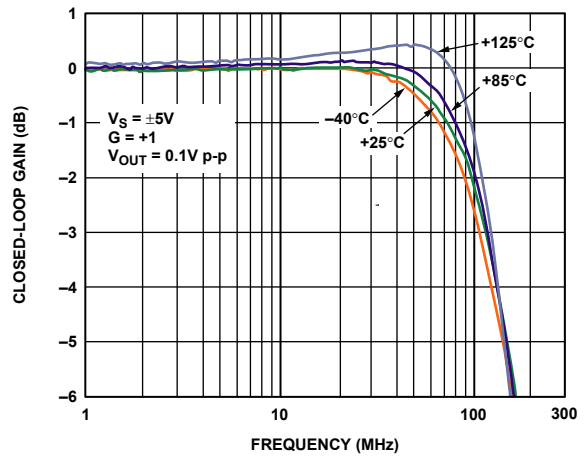

Figure 10. Small-Signal Frequency Response for Various Temperatures

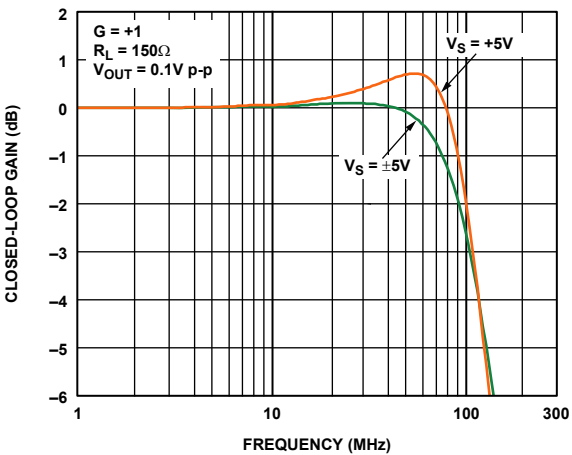

Figure 8. Small-Signal Frequency Response for Various Supplies

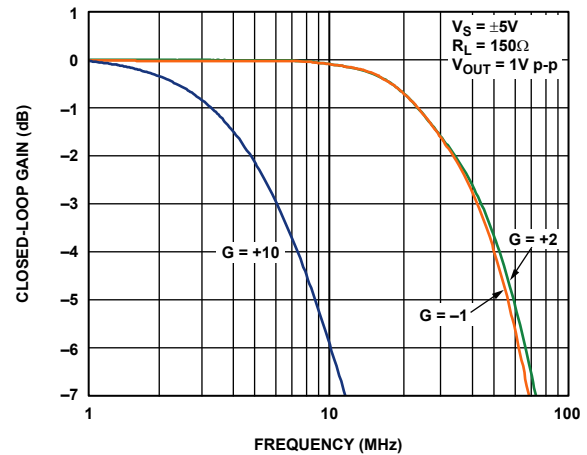

Figure 11. Large-Signal Frequency Response for Various Gains

ADA4851-1/ADA4851-2/ADA4851-4

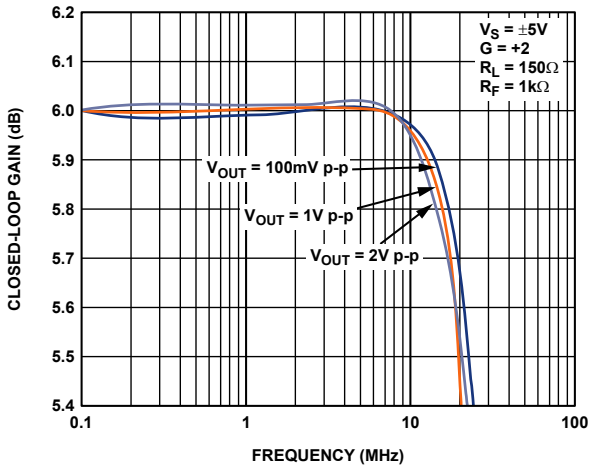

Figure 12. 0.1 dB Flatness Response for Various Output Amplitudes

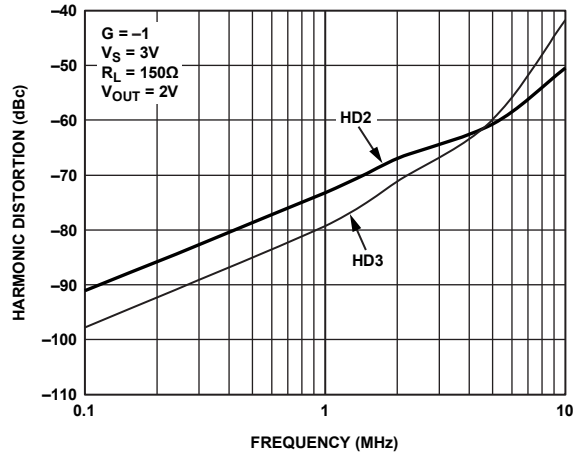

Figure 15. Harmonic Distortion vs. Frequency

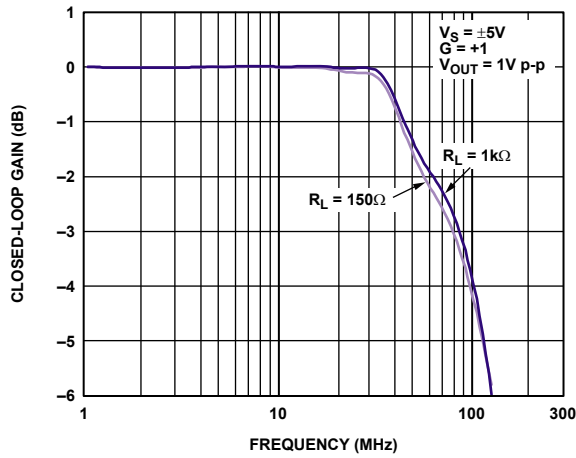

Figure 13. Large Frequency Response for Various Loads

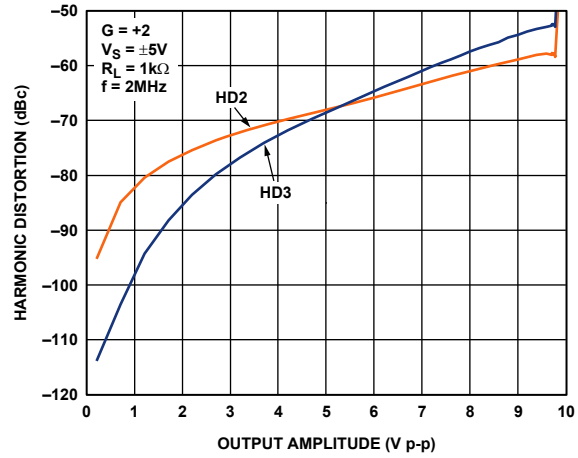

Figure 16. Harmonic Distortion vs. Output Amplitude

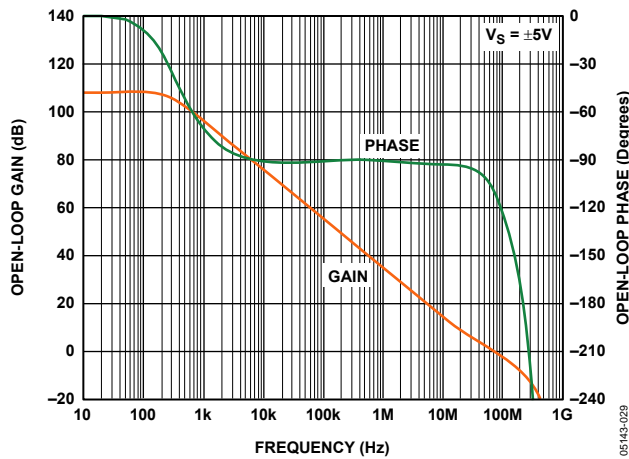

Figure 14. Open-Loop Gain and Phase vs. Frequency

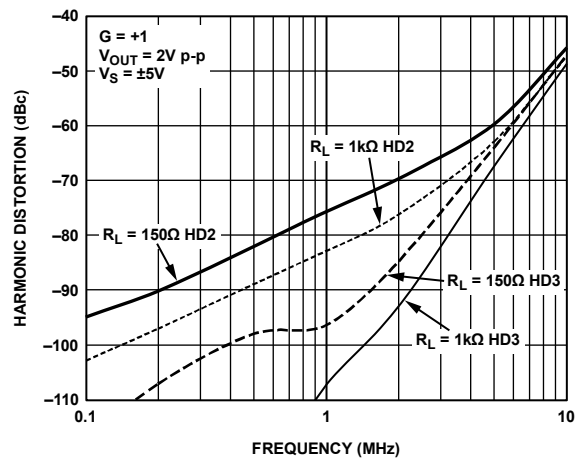

Figure 17. Harmonic Distortion vs. Frequency for Various Loads

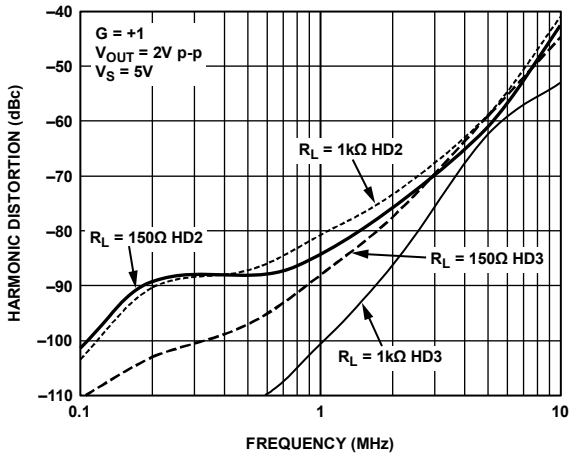

Figure 18. Harmonic Distortion vs. Frequency for Various Loads

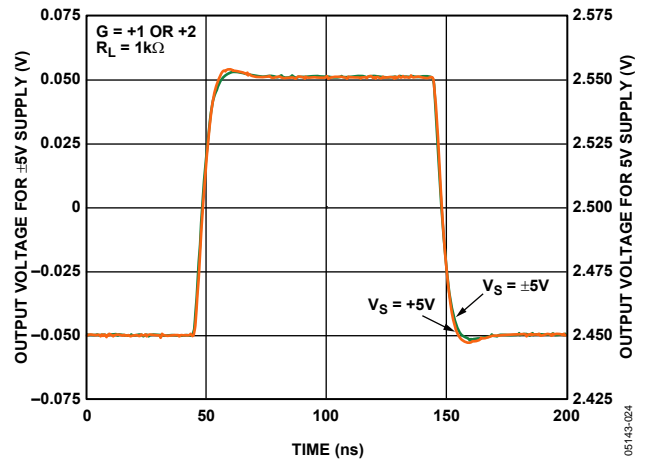

Figure 21. Small-Signal Transient Response for Various Supplies

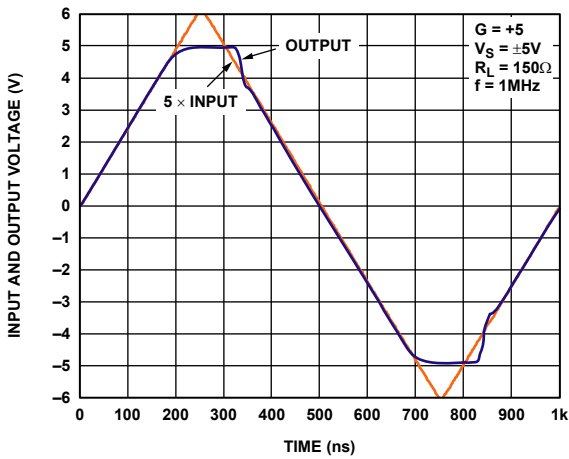

Figure 19. Output Overdrive Recovery

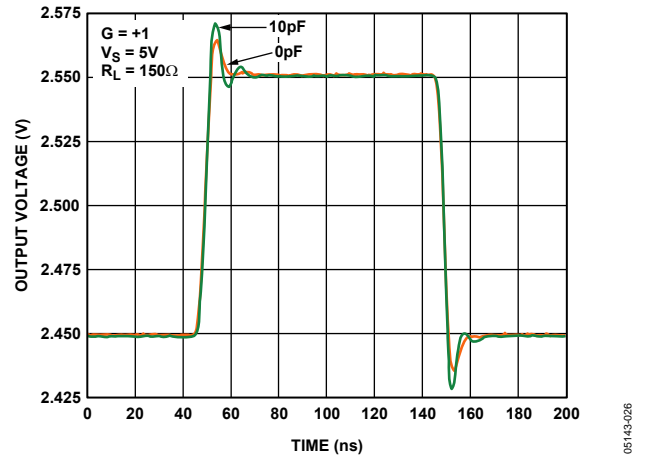

Figure 22. Small-Signal Transient Response for Various Capacitive Loads

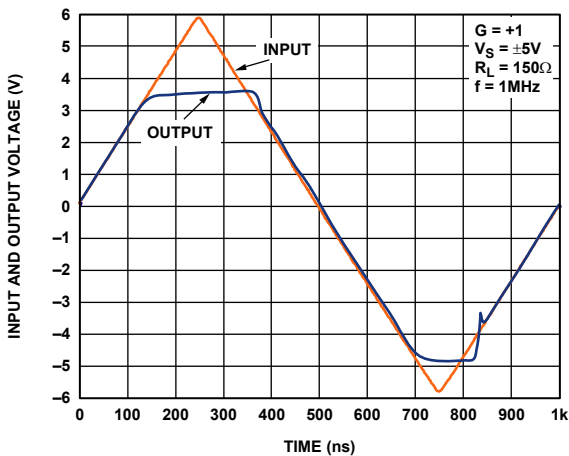

Figure 20. Input Overdrive Recovery

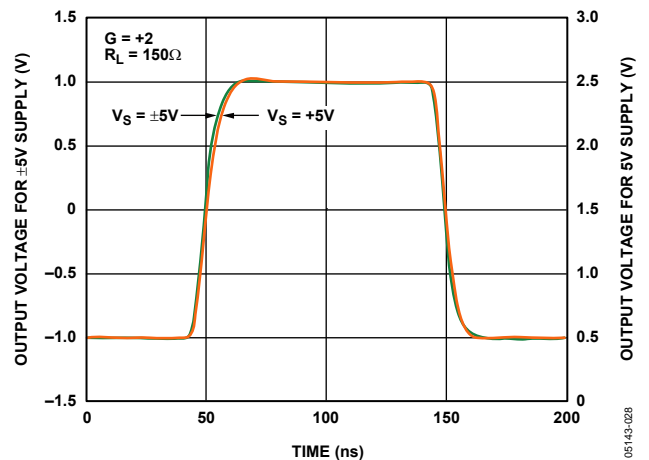

Figure 23. Large-Signal Transient Response for Various Supplies

ADA4851-1/ADA4851-2/ADA4851-4

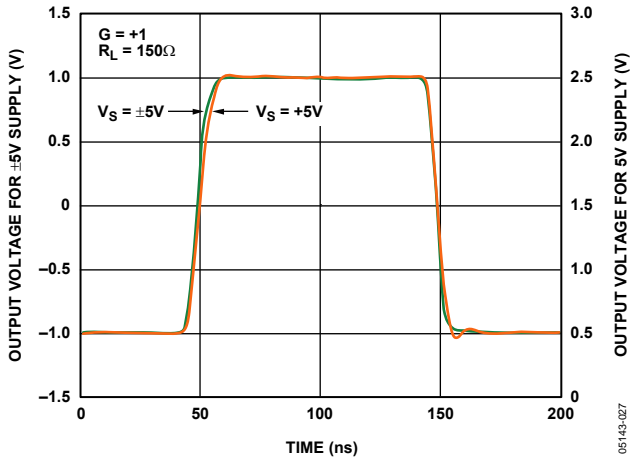

Figure 24. Large-Signal Transient Response for Various Supplies

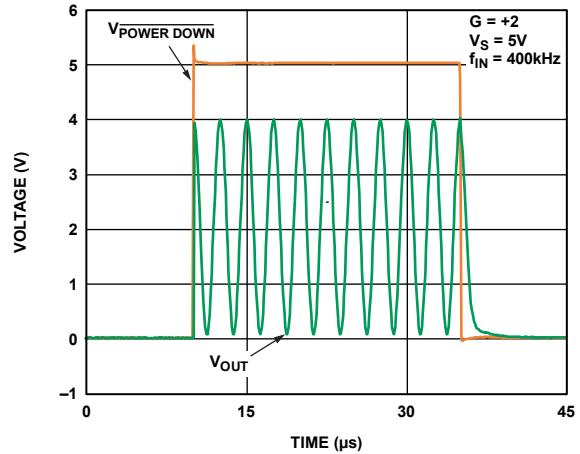

Figure 27. ADA4851-1, Power-Up/Power-Down Time

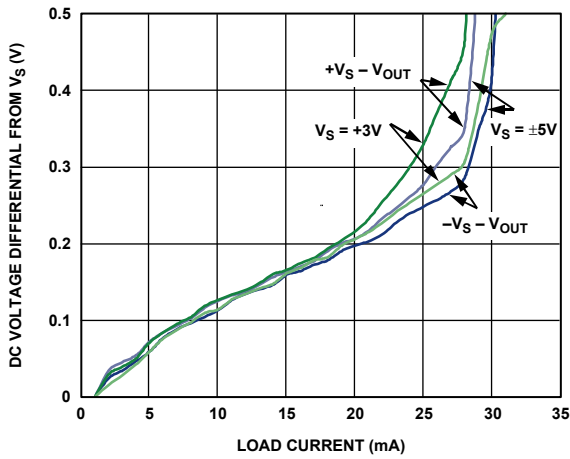

Figure 25. Output Saturation Voltage vs. Load Current

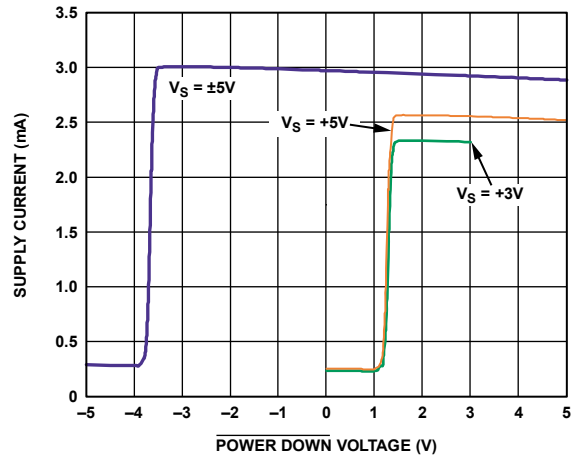

Figure 28. ADA4851-1, Supply Current vs. POWER_DOWN Pin Voltage

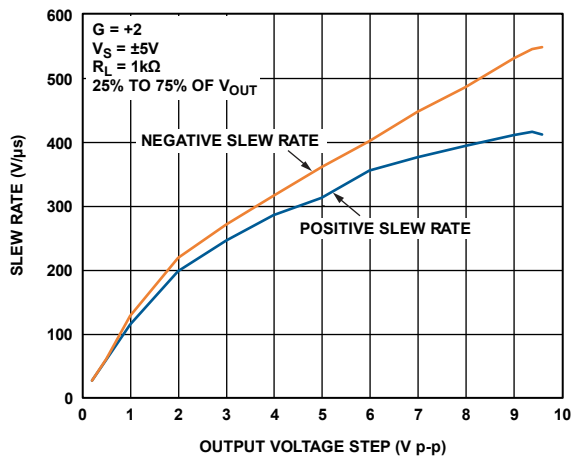

Figure 26. Slew Rate vs. Output Voltage Step

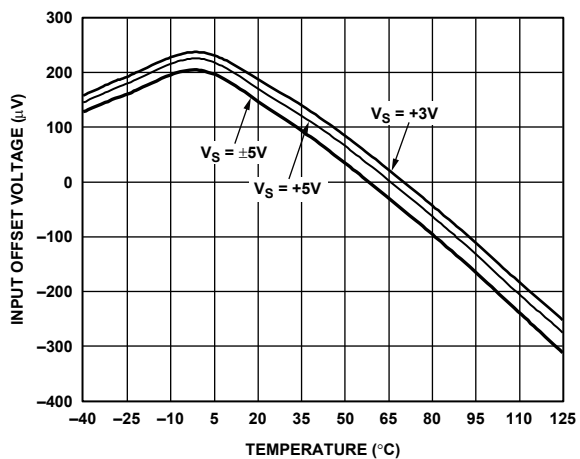

Figure 29. Input Offset Voltage vs. Temperature for Various Supplies

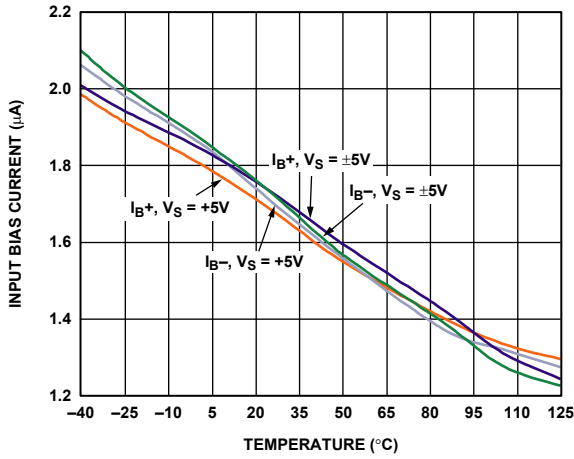

Figure 30. Input Bias Current vs. Temperature for Various Supplies

05143-036

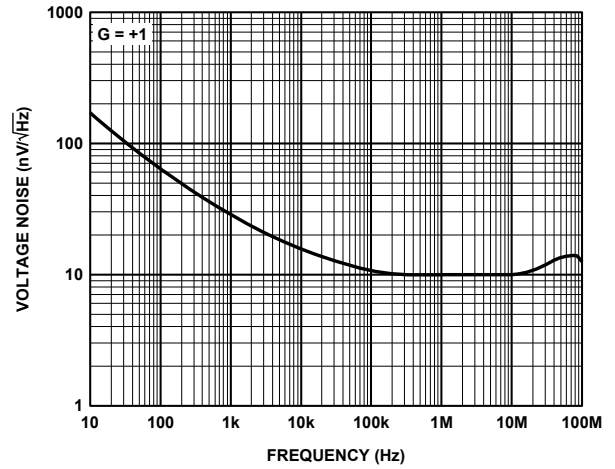

Figure 33. Voltage Noise vs. Frequency

05143-044

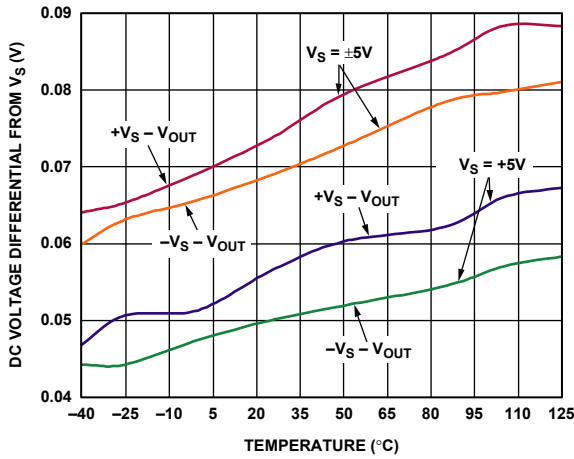

Figure 31. Output Saturation vs. Temperature for Various Supplies

05143-037

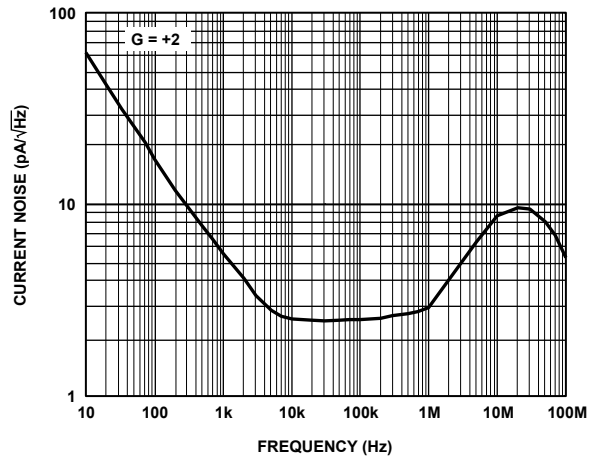

Figure 34. Current Noise vs. Frequency

05143-045

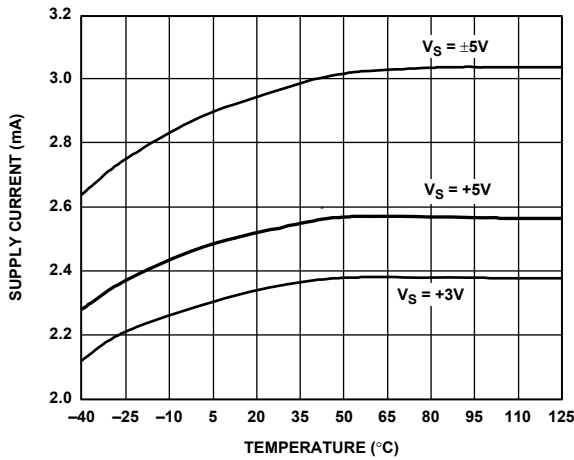

Figure 32. Supply Current vs. Temperature for Various Supplies

05143-038

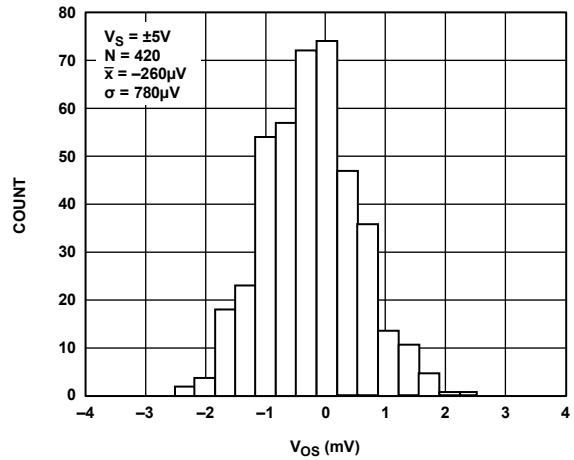

Figure 35. Input Offset Voltage Distribution

05143-047

ADA4851-1/ADA4851-2/ADA4851-4

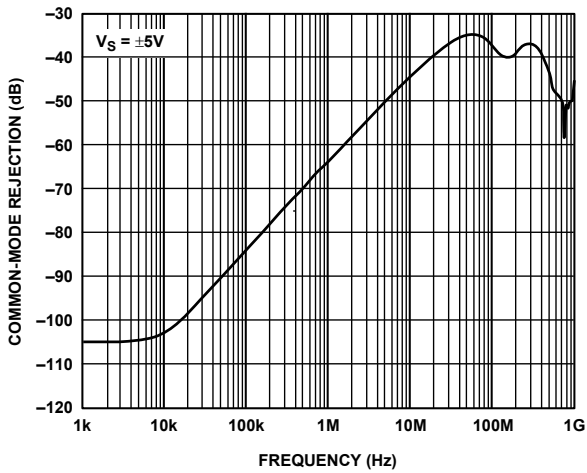

Figure 36. Common-Mode Rejection Ratio (CMRR) vs. Frequency

05143-020

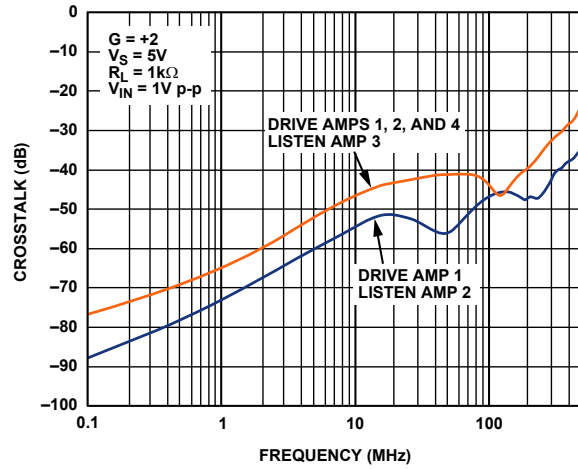

Figure 38. ADA4851-4, RTI Crosstalk vs. Frequency

05143-055

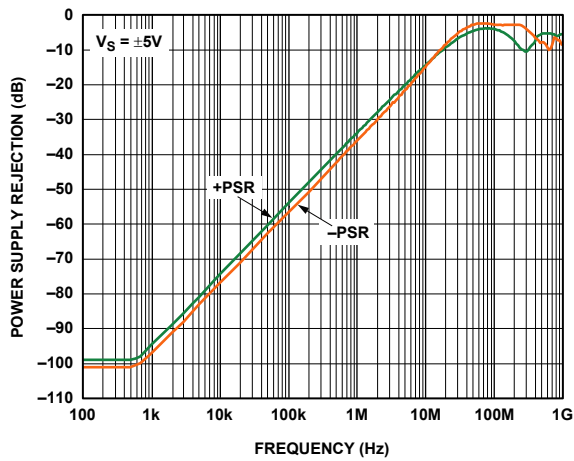

Figure 37. Power Supply Rejection (PSR) vs. Frequency

05143-023

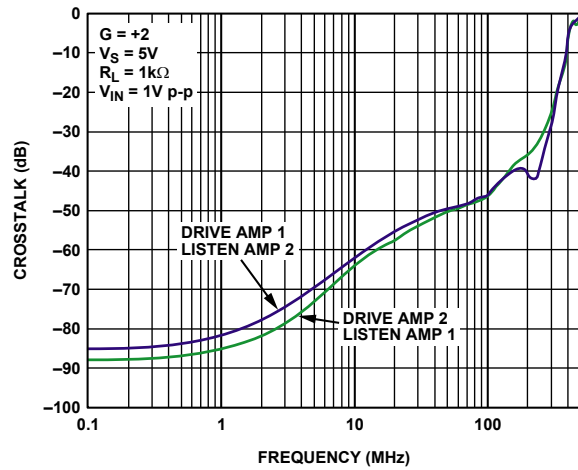

Figure 39. ADA4851-2, RTI Crosstalk vs. Frequency

05143-060

CIRCUIT DESCRIPTION

The ADA4851-1/ADA4851-2/ADA4851-4 feature a high slew rate input stage that is a true single-supply topology, capable of sensing signals at or below the negative supply rail. The rail-to-rail output stage can pull within 60 mV of either supply rail when driving light loads and within 0.17 V when driving 150 Ω. High speed performance is maintained at supply voltages as low as 2.7 V.

HEADROOM CONSIDERATIONS

These amplifiers are designed for use in low voltage systems. To obtain optimum performance, it is useful to understand the behavior of the amplifiers as input and output signals approach the headroom limits of the amplifiers. The input common-mode voltage range of the amplifiers extends from the negative supply voltage (actually 200 mV below the negative supply), or from ground for single-supply operation, to within 2.2 V of the positive supply voltage. Therefore, at a gain of 3, the amplifiers can provide full rail-to-rail output swing for supply voltages as low as 3.3 V and down to 3 V for a gain of 4.

Exceeding the headroom limit is not a concern for any inverting gain on any supply voltage as long as the reference voltage at the positive input of the amplifier lies within the input common-mode range of the amplifier.

The input stage is the headroom limit for signals approaching the positive rail. Figure 40 shows a typical offset voltage vs. the input common-mode voltage for the ADA4851-1/ADA4851-2/ADA4851-4 amplifiers on a ±5 V supply. Accurate dc performance is maintained from approximately 200 mV below the negative supply to within 2.2 V of the positive supply. For high speed signals, however, there are other considerations. Figure 41 shows -3 dB bandwidth vs. input common-mode voltage for a unity-gain follower. As the common-mode voltage approaches 2 V of positive supply, the amplifier responds well but the bandwidth begins to drop as the common-mode voltage approaches the positive supply. This can manifest itself in increased distortion or settling time. Higher frequency signals require more headroom than the lower frequencies to maintain distortion performance.

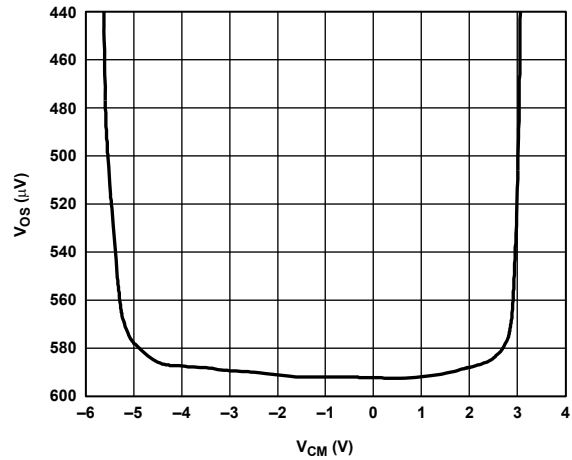

Figure 40. V_{OS} vs. Common-Mode Voltage, $V_S = \pm 5\text{ V}$

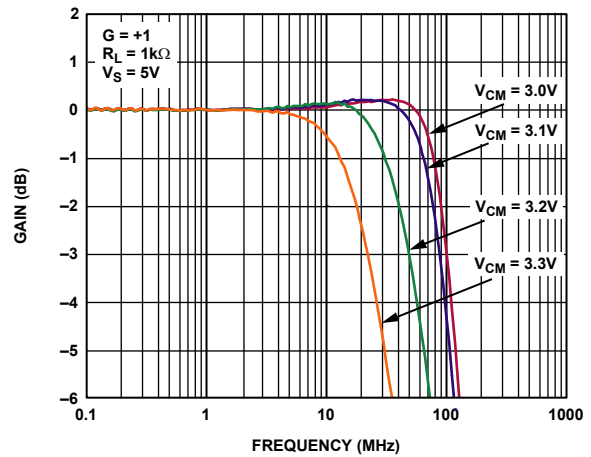

Figure 41. Unity-Gain Follower Bandwidth vs. Input Common-Mode

ADA4851-1/ADA4851-2/ADA4851-4

Figure 42 illustrates how the rising edge settling time for the amplifier is configured as a unity-gain follower, stretching out as the top of a 1 V step input that approaches and exceeds the specified input common-mode voltage limit.

For signals approaching the negative supply and inverting gain and high positive gain configurations, the headroom limit is the output stage. The ADA4851-1/ADA4851-2/ADA4851-4 amplifiers use a common emitter output stage. This output stage maximizes the available output range, limited by the saturation voltage of the output transistors. The saturation voltage increases with the drive current that the output transistor is required to supply due to the collector resistance of the output transistor.

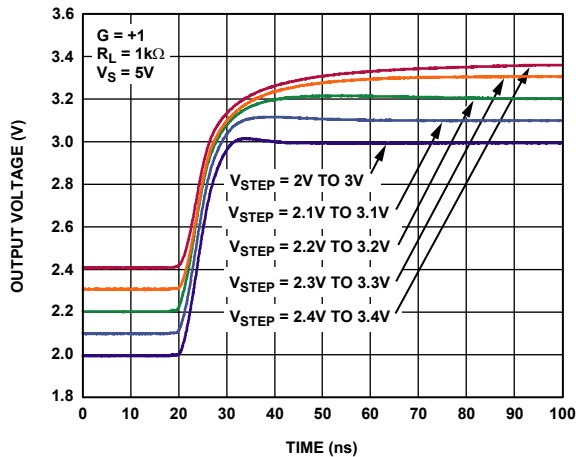

Figure 42. Output Rising Edge for 1 V Step at Input Headroom Limits

As the saturation point of the output stage is approached, the output signal shows increasing amounts of compression and clipping. As in the input headroom case, higher frequency signals require slightly more headroom than the lower frequency signals. Figure 16 illustrates this point by plotting the typical harmonic distortion vs. the output amplitude.

OVERLOAD BEHAVIOR AND RECOVERY

Input

The specified input common-mode voltage of the ADA4851-1/ADA4851-2/ADA4851-4 is 200 mV below the negative supply to within 2.2 V of the positive supply. Exceeding the top limit results in lower bandwidth and increased rise time, as shown in Figure 41 and Figure 42. Pushing the input voltage of a unity-gain follower to less than 2 V from the positive supply leads to the behavior shown in Figure 43—an increasing amount of output error as well as a much increased settling time. The recovery time from input voltages of 2.2 V or closer to the positive supply is approximately 55 ns, which is limited by the settling artifacts caused by transistors in the input stage coming out of saturation.

The amplifiers do not exhibit phase reversal, even for input voltages beyond the voltage supply rails. Going more than 0.6 V beyond the power supplies turns on protection diodes at the input stage, which greatly increases the current draw of the devices.

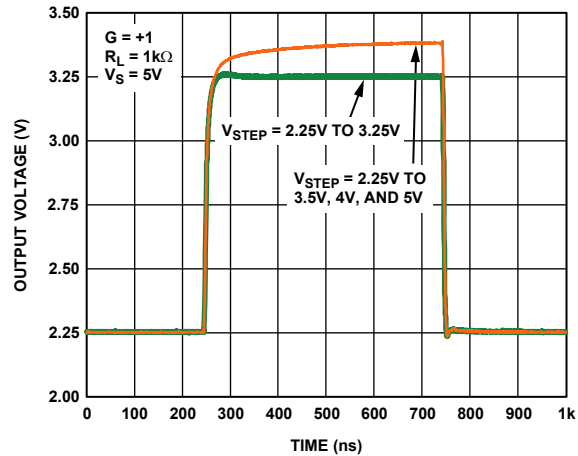

Figure 43. Pulse Response of $G = +1$ Follower, Input Step Overloading the Input Stage

Output

Output overload recovery is typically within 35 ns after the input of the amplifier is brought to a nonoverloading value. Figure 44 shows output recovery transients for the amplifier configured in an inverting gain of 1 recovering from a saturated output from the top and bottom supplies to a point at midsupply.

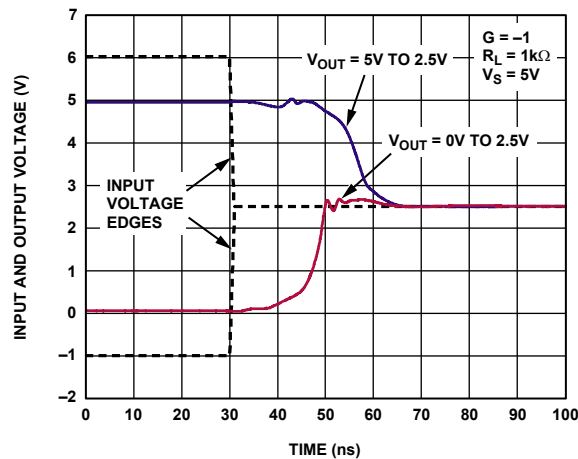

Figure 44. Overload Recovery

SINGLE-SUPPLY VIDEO AMPLIFIER

The ADA4851 family of amplifiers is well suited for portable video applications. When operating in low voltage single-supply applications, the input signal is limited by the input stage headroom. For additional information, see the Headroom Considerations section. Table 6 shows the recommended values for voltage, input signal, various gains, and output signal swing for the typical video amplifier shown in Figure 45.

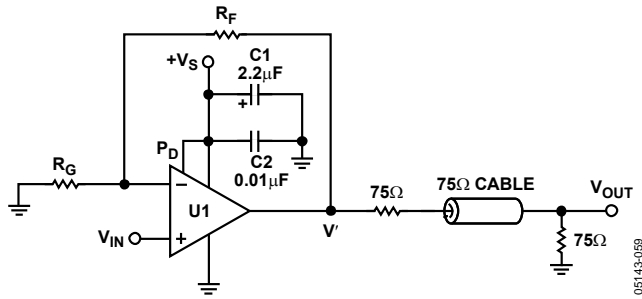

Figure 45. Video Amplifier

Table 6. Recommended Values

Supply Voltage (V)	Input Range (V)	R _G (kΩ)	R _F (kΩ)	Gain (V/V)	V' (V)	V _{OUT} (V)
3	0 to 0.8	1	1	2	1.6	0.8
3	0 to 0.8	0.499	1	3	2.4	1.2
5	0 to 2.8	1	1	2	4.9	2.45

VIDEO RECONSTRUCTION FILTER

At higher frequencies, active filters require wider bandwidths to work properly. Excessive phase shift introduced by lower frequency op amps can significantly affect the filter performance.

A common application for active filters is at the output of video DACs/encoders. The filter, or more appropriately, the video reconstruction filter, is used at the output of a video DAC/encoder to eliminate the multiple images that are created during the sampling process within the DAC. For portable video applications, the ADA4851 family of amplifiers is an ideal choice due to its lower power requirements and high performance.

An example of an 8 MHz, three-pole, Sallen-Key, low-pass, video reconstruction filter is shown in Figure 46. This circuit features a gain of 3, has a 0.1 dB bandwidth of 8.2 MHz, and over 17 dB attenuation at 27 MHz (see Figure 47). The filter has three poles; two are active with a third passive pole (R6 and C4) placed at the output. C3 improves the filter roll-off. R6, R7, and R8 comprise the video load of 150 Ω. Components R6, C4, R7, R8, and the input termination of the network analyzer form a 12.8 dB attenuator; therefore, the reference level is roughly -3.3 dB, as shown in Figure 47.

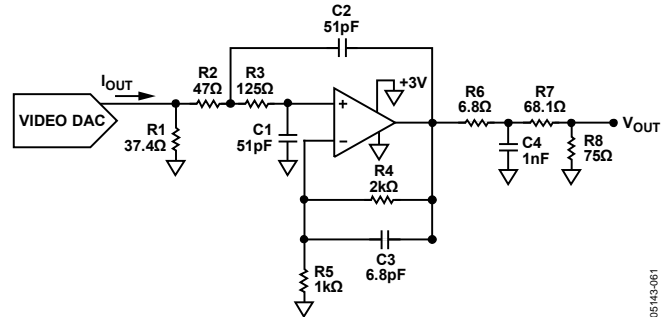

Figure 46. 8 MHz Video Reconstruction Filter Schematic

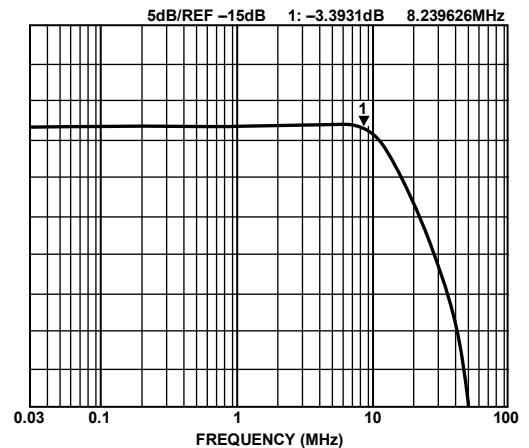
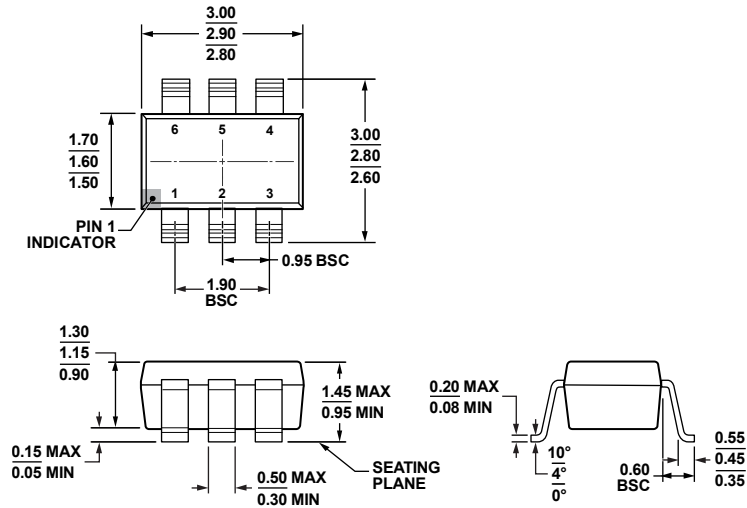

Figure 47. Video Reconstruction Filter Frequency Performance

OUTLINE DIMENSIONS



COMPLIANT TO JEDEC STANDARDS MO-178-AB
 Figure 48. 6-Lead Small Outline Transistor Package [SOT-23]
 (RJ-6)
 Dimensions shown in millimeters

121608-A

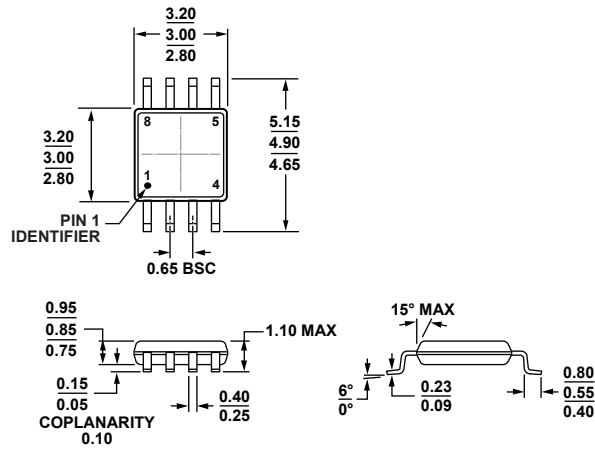

COMPLIANT TO JEDEC STANDARDS MO-187-AA
 Figure 49. 8-Lead Mini Small Outline Package [MSOP]
 (RM-8)
 Dimensions shown in millimeters

10-07-2009-B

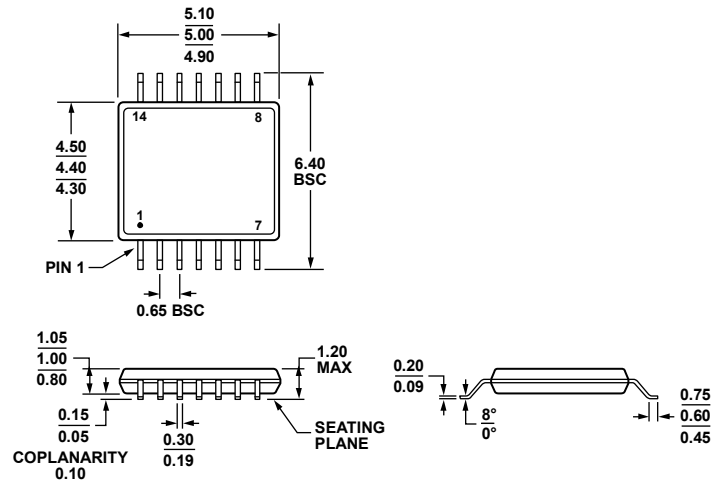

COMPLIANT TO JEDEC STANDARDS MO-153-AB-1
 Figure 50. 14-Lead Thin Shrink Small Outline Package [TSSOP]
 (RU-14)
 Dimensions shown in millimeters

ORDERING GUIDE

Model ^{1, 2}	Temperature Range	Package Description	Package Option	Branding
ADA4851-1YRJZ-R2	-40°C to +125°C	6-Lead Small Outline Transistor Package (SOT-23)	RJ-6	HHB
ADA4851-1YRJZ-RL	-40°C to +125°C	6-Lead Small Outline Transistor Package (SOT-23)	RJ-6	HHB
ADA4851-1YRJZ-RL7	-40°C to +125°C	6-Lead Small Outline Transistor Package (SOT-23)	RJ-6	HHB
ADA4851-1WYRJZ-R7	-40°C to +125°C	6-Lead Small Outline Transistor Package (SOT-23)	RJ-6	H1Z
ADA4851-2YRMZ	-40°C to +125°C	8-Lead Mini Small Outline Package (MSOP)	RM-8	HSB
ADA4851-2YRMZ-RL	-40°C to +125°C	8-Lead Mini Small Outline Package (MSOP)	RM-8	HSB
ADA4851-2YRMZ-RL7	-40°C to +125°C	8-Lead Mini Small Outline Package (MSOP)	RM-8	HSB
ADA4851-2WYRMZ-R7	-40°C to +125°C	8-Lead Mini Small Outline Package (MSOP)	RM-8	H1Y
ADA4851-4YRUZ	-40°C to +125°C	14-Lead Thin Shrink Small Outline Package (TSSOP)	RU-14	
ADA4851-4YRUZ-RL	-40°C to +125°C	14-Lead Thin Shrink Small Outline Package (TSSOP)	RU-14	
ADA4851-4YRUZ-RL7	-40°C to +125°C	14-Lead Thin Shrink Small Outline Package (TSSOP)	RU-14	
ADA4851-4WYRUZ-R7	-40°C to +125°C	14-Lead Thin Shrink Small Outline Package (TSSOP)	RU-14	
ADA4851-1YRJ-EBZ		6-Lead SOT-23 Evaluation Board		
ADA4851-2YRM-EBZ		8-Lead MSOP Evaluation Board		
ADA4851-4YRU-EBZ		14-Lead TSSOP Evaluation Board		

¹ Z = RoHS Compliant Part.
² W = qualified for automotive applications.

AUTOMOTIVE PRODUCTS

The ADA4851-1W/ADA4851-2W/ADA4851-4W models are available with controlled manufacturing to support the quality and reliability requirements of automotive applications. Note that these automotive models may have specifications that differ from the commercial models; therefore, designers should review the Specifications section of this data sheet carefully. Only the automotive grade products shown are available for use in automotive applications. Contact your local Analog Devices, Inc., account representative for specific product ordering information and to obtain the specific Automotive Reliability reports for these models.

NOTES

NOTES

NOTES

Компания «Life Electronics» занимается поставками электронных компонентов импортного и отечественного производства от производителей и со складов крупных дистрибьюторов Европы, Америки и Азии.

С конца 2013 года компания активно расширяет линейку поставок компонентов по направлению коаксиальный кабель, кварцевые генераторы и конденсаторы (керамические, пленочные, электролитические), за счёт заключения дистрибьюторских договоров

Мы предлагаем:

- Конкурентоспособные цены и скидки постоянным клиентам.
- Специальные условия для постоянных клиентов.
- Подбор аналогов.
- Поставку компонентов в любых объемах, удовлетворяющих вашим потребностям.
- Приемлемые сроки поставки, возможна ускоренная поставка.
- Доставку товара в любую точку России и стран СНГ.
- Комплексную поставку.
- Работу по проектам и поставку образцов.
- Формирование склада под заказчика.
- Сертификаты соответствия на поставляемую продукцию (по желанию клиента).
- Тестирование поставляемой продукции.
- Поставку компонентов, требующих военную и космическую приемку.
- Входной контроль качества.
- Наличие сертификата ISO.

В составе нашей компании организован Конструкторский отдел, призванный помогать разработчикам, и инженерам.

Конструкторский отдел помогает осуществить:

- Регистрацию проекта у производителя компонентов.
- Техническую поддержку проекта.
- Защиту от снятия компонента с производства.
- Оценку стоимости проекта по компонентам.
- Изготовление тестовой платы монтаж и пусконаладочные работы.



Тел: +7 (812) 336 43 04 (многоканальный)

Email: org@lifeelectronics.ru