

HEIDI-D

~10° diffused spot beam optimized for LUXEON Rebel ES

TECHNICAL SPECIFICATIONS:

Dimensions	Ø 21.6 mm
Height	11.7 mm
Fastening	tape, pin
ROHS compliant	yes ⓘ

MATERIAL SPECIFICATIONS:

Component	Type	Material	Colour	Finish
HEIDI-D	Single lens	PMMA	clear	
HEIDI-TAPE	Tape	PU tape	black	

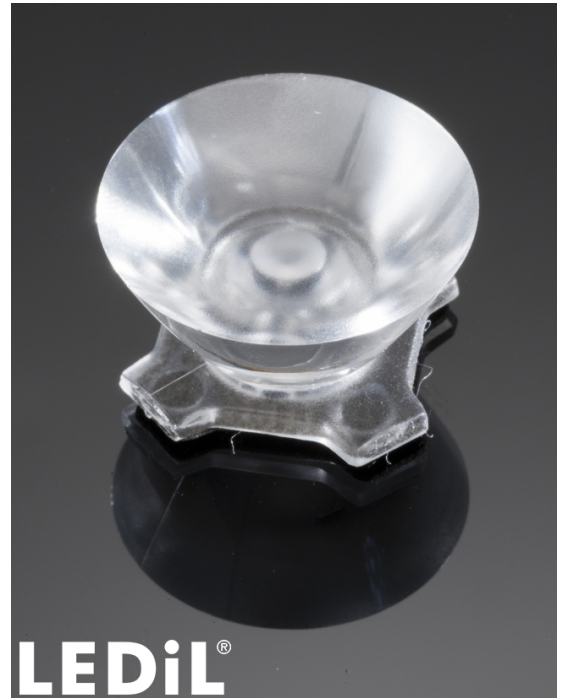

ORDERING INFORMATION:

Component		Qty in box	MOQ	MPQ	Box weight (kg)
CA12530_HEIDI-D	Single lens	3264	204	204	10.3
» Box size: 480 x 280 x 300 mm					

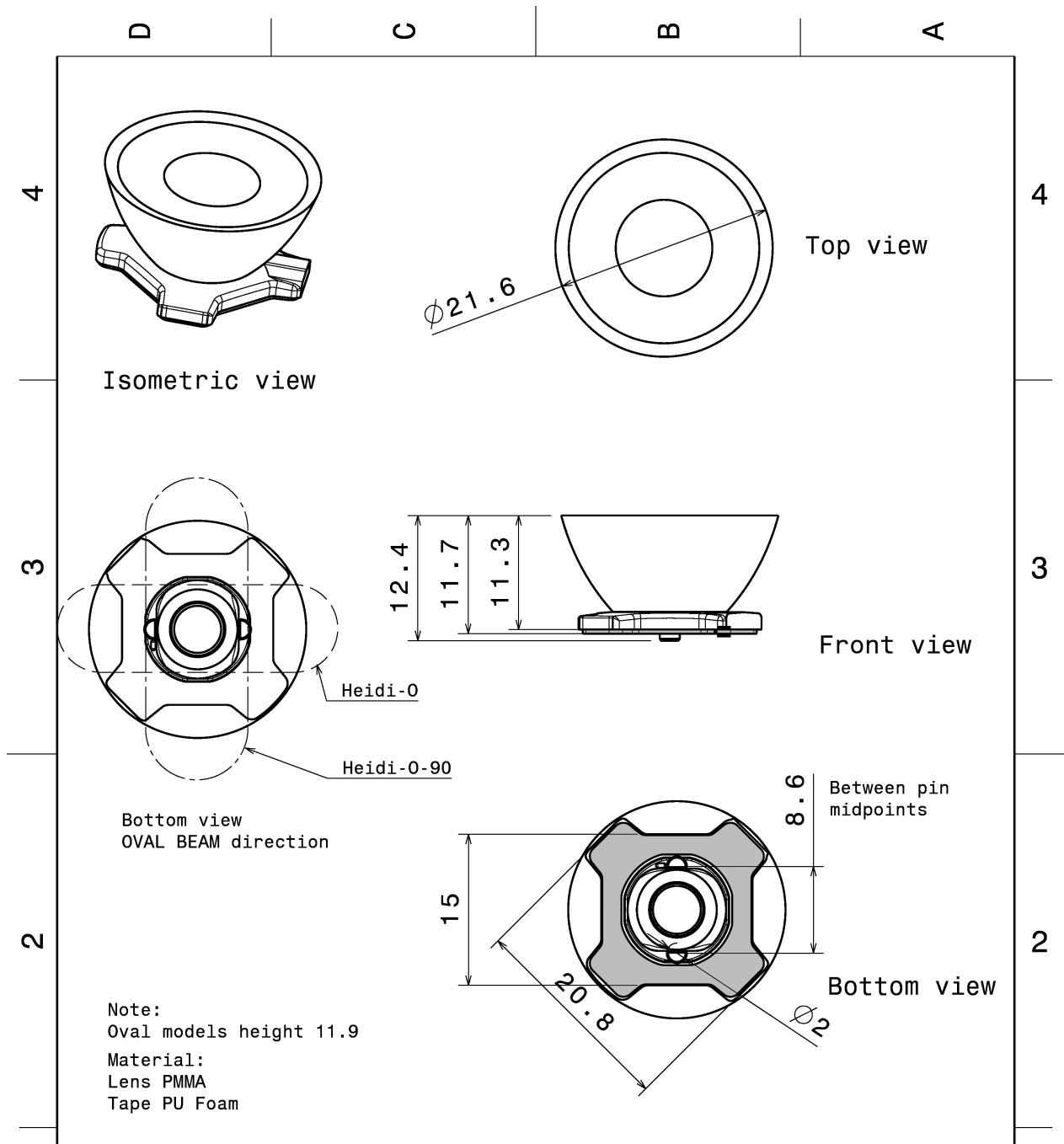

This drawing is our property. It can't be reproduced or communicated without our written agreement.		LEDiL		Ledil Oy Joensuunkatu 13 FIN-24100 SALO Finland	
DRAWING TITLE		Datasheet Heidi-Series Assy			
DRAWN BY ah	DATE 1.2.2012	SIZE A4		DRAWING NUMBER	
CHECKED BY	DATE	SCALE 2:1			REV 2
DESIGNED BY	DATE	WEIGHT (g)		SHEET 1/1	

PHOTOMETRIC DATA (MEASURED):

CREE 

LED XHP35 HD
FWHM 20.0°
Efficiency 83 %
Peak intensity 4.2 cd/lm
LEDs/each optic 1
Light colour White
Required components:

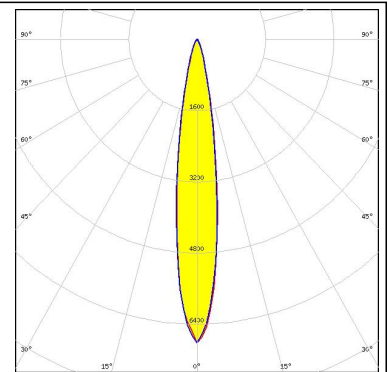

CREE 

LED XHP35 HI
FWHM 17.0°
Efficiency 94 %
Peak intensity 5.7 cd/lm
LEDs/each optic 1
Light colour White
Required components:

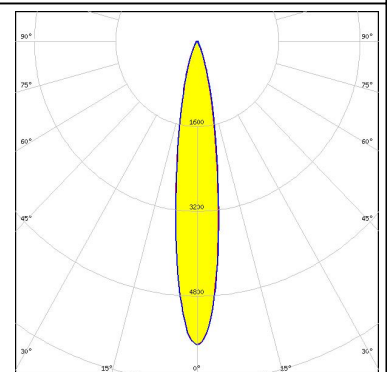
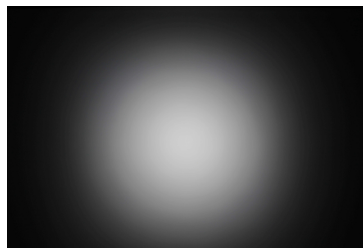

CREE 

LED XP-G2
FWHM 15.0°
Efficiency 94 %
Peak intensity 6.6 cd/lm
LEDs/each optic 1
Light colour White
Required components:

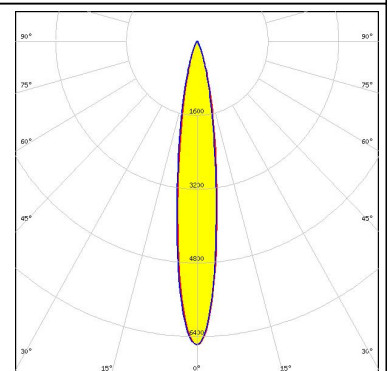
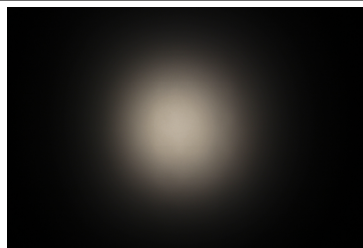

CREE 

LED XP-G3
FWHM 17.0°
Efficiency 94 %
Peak intensity 5.1 cd/lm
LEDs/each optic 1
Light colour White
Required components:

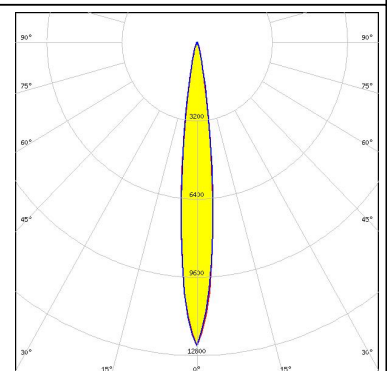
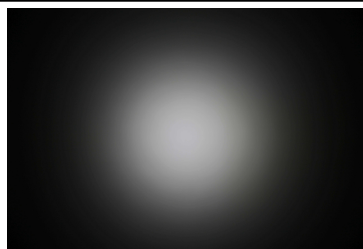

PHOTOMETRIC DATA (MEASURED):



LED XP-L HD
 FWHM 18.0°
 Efficiency 85 %
 Peak intensity 4.8 cd/lm
 LEDs/each optic 1
 Light colour White
 Required components:

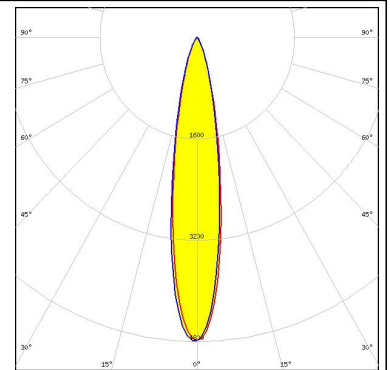

LED XT-E
 FWHM 14.0°
 Efficiency 94 %
 Peak intensity 7.9 cd/lm
 LEDs/each optic 1
 Light colour White
 Required components:

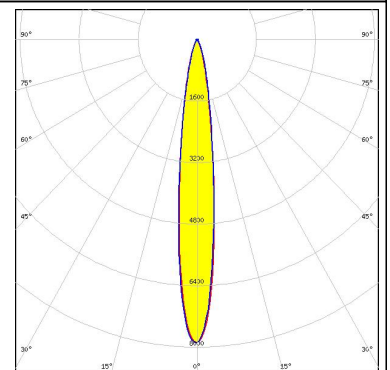
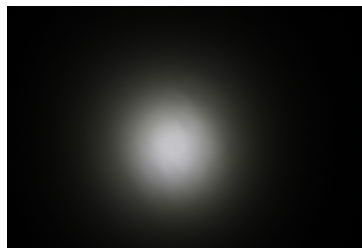

LED LUXEON A
 FWHM 12.0°
 Efficiency 86 %
 Peak intensity 10 cd/lm
 LEDs/each optic 1
 Light colour White
 Required components:

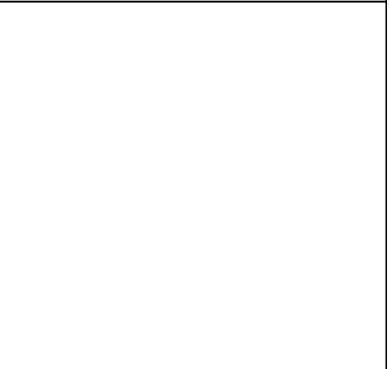
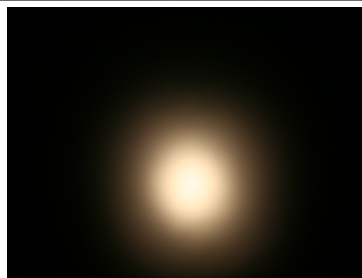

LED LUXEON Rebel
 FWHM 14.0°
 Efficiency 86 %
 Peak intensity 7.5 cd/lm
 LEDs/each optic 1
 Light colour White
 Required components:

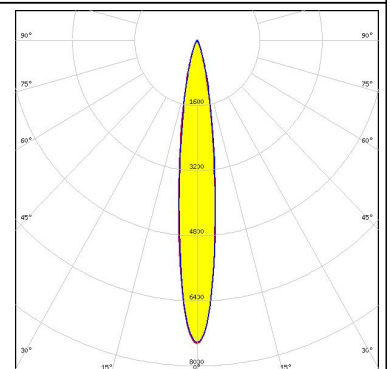

PHOTOMETRIC DATA (MEASURED):



LED LUXEON Rebel ES
 FWHM 15.0°
 Efficiency 91 %
 Peak intensity 6.5 cd/lm
 LEDs/each optic 1
 Light colour White
 Required components:

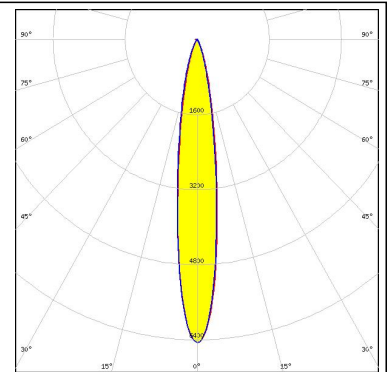
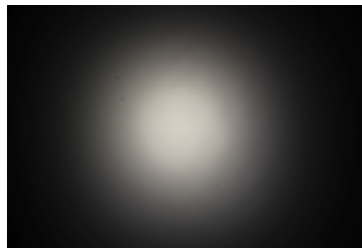

LED SST-10-B130
 FWHM 14.0°
 Efficiency 93 %
 Peak intensity 7.9 cd/lm
 LEDs/each optic 1
 Light colour Blue
 Required components:

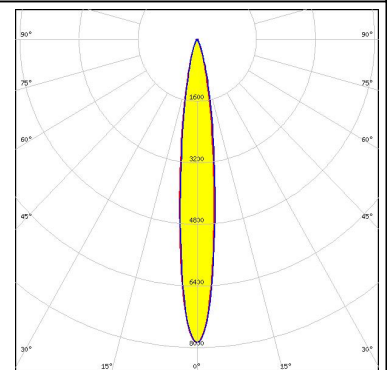



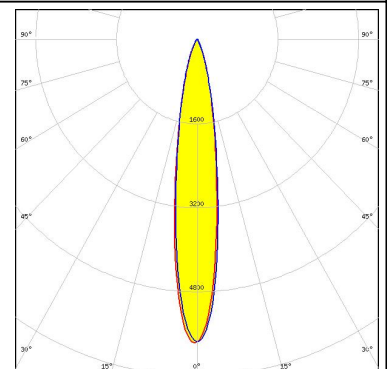
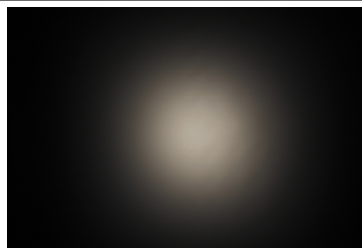

LED NVSW219D
 FWHM 16.0°
 Efficiency 94 %
 Peak intensity 5.8 cd/lm
 LEDs/each optic 1
 Light colour White
 Required components:

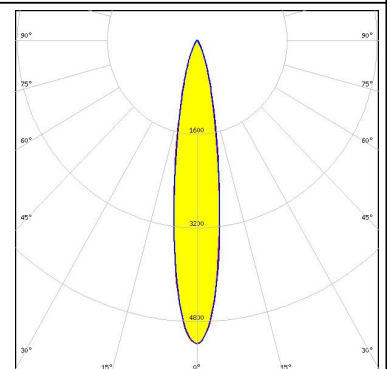
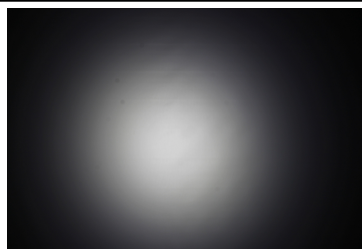

LED NVSW319B
 FWHM 18.0°
 Efficiency 93 %
 Peak intensity 5.2 cd/lm
 LEDs/each optic 1
 Light colour White
 Required components:

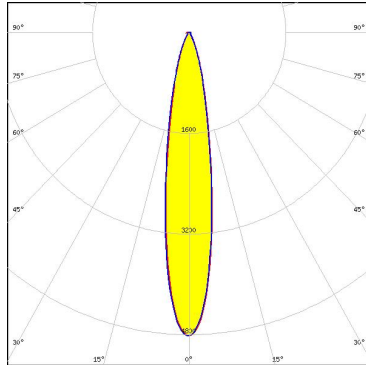
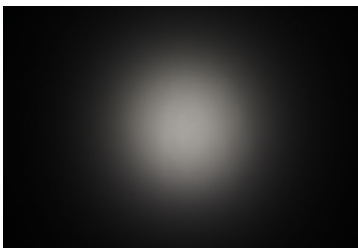
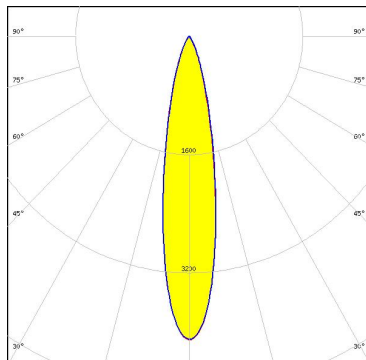

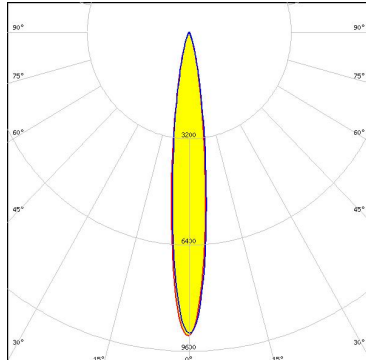
PHOTOMETRIC DATA (MEASURED):

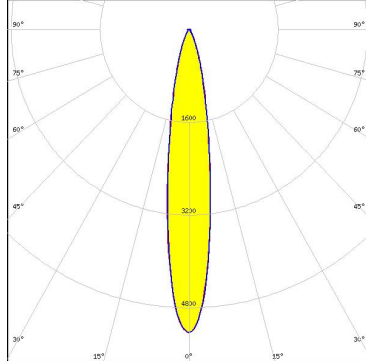
<p>NICHIA</p> <p>LED NVSW3x9A FWHM 18.0° Efficiency 90 % Peak intensity 4.8 cd/lm LEDs/each optic 1 Light colour White Required components:</p>		
<p>NICHIA</p> <p>LED NWSx229A FWHM 20.0° Efficiency 84 % Peak intensity 4.1 cd/lm LEDs/each optic 1 Light colour White Required components:</p>		
<p>OSRAM <small>Opto Semiconductors</small></p> <p>LED OSLON SSL 150 FWHM 13.0° Efficiency 87 % Peak intensity 9.1 cd/lm LEDs/each optic 1 Light colour White Required components:</p>		
<p>SEOUL SEMICONDUCTOR</p> <p>LED Z5M3 FWHM 17.0° Efficiency 94 % Peak intensity 5.2 cd/lm LEDs/each optic 1 Light colour White Required components:</p>		

PHOTOMETRIC DATA (MEASURED):



PHOTOMETRIC DATA (SIMULATED):



LED XP-G2 HE
 FWHM 14.0°
 Efficiency 95 %
 Peak intensity 10.7 cd/lm
 LEDs/each optic 1
 Light colour White
 Required components:

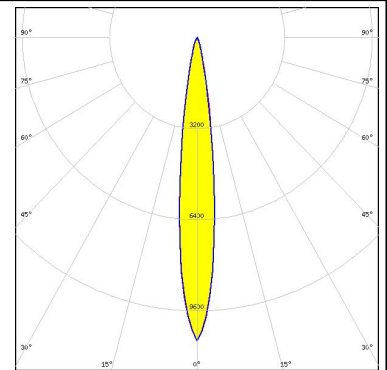

LED LUXEON R
 FWHM 12.0°
 Efficiency %
 LEDs/each optic 1
 Light colour White
 Required components:



LED LUXEON SunPlus 20 Line (120 deg)
 FWHM 9.0°
 Efficiency 96 %
 Peak intensity 26.1 cd/lm
 LEDs/each optic 1
 Light colour White
 Required components:

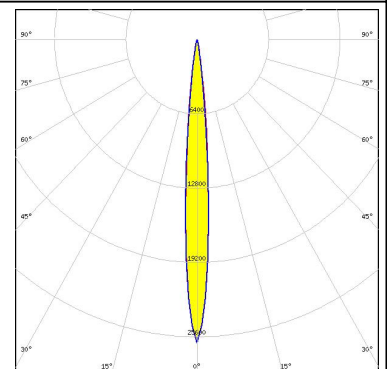

LED LUXEON SunPlus 20 Line (150 deg)
 FWHM 8.7°
 Efficiency 93 %
 Peak intensity 25.6 cd/lm
 LEDs/each optic 1
 Light colour White
 Required components:

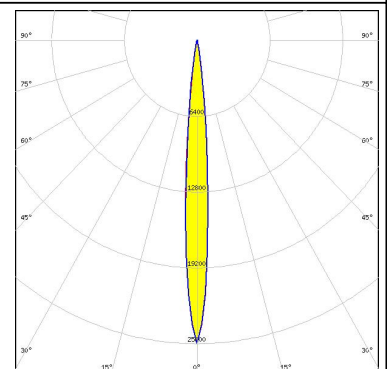

PHOTOMETRIC DATA (SIMULATED):

LUMILEDS

LED LUXEON SunPlus 20 Line (150 deg)
 FWHM 8.0°
 Efficiency 92 %
 Peak intensity 24.9 cd/lm
 LEDs/each optic 1
 Light colour White
 Required components:

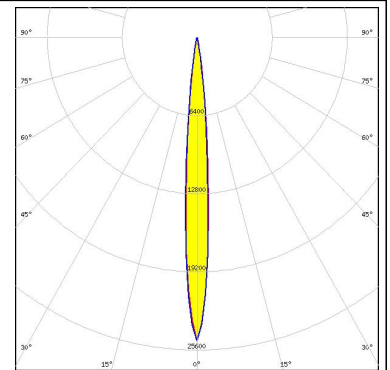

LUMILEDS

LED LUXEON SunPlus 35 Line
 FWHM 8.5°
 Efficiency 94 %
 Peak intensity 27.2 cd/lm
 LEDs/each optic 1
 Light colour White
 Required components:

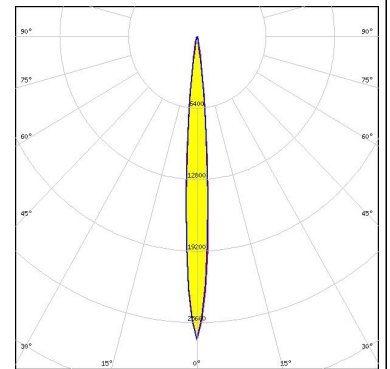

LUMILEDS

LED LUXEON Z ES
 FWHM 10.0°
 Efficiency 94 %
 Peak intensity 20.5 cd/lm
 LEDs/each optic 1
 Light colour White
 Required components:

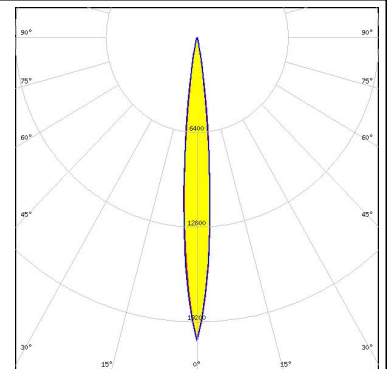

NICHIA

LED NCSxE17A
 FWHM 10.0°
 Efficiency 92 %
 Peak intensity 18.2 cd/lm
 LEDs/each optic 1
 Light colour White
 Required components:

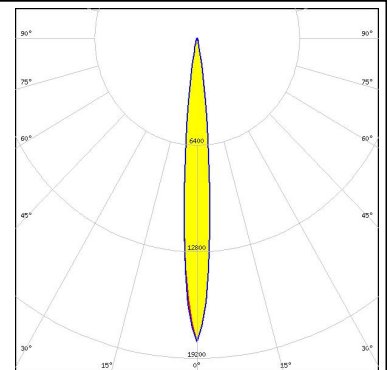

PHOTOMETRIC DATA (SIMULATED):



LED NV4WB35AM
FWHM 16.0°
Efficiency 96 %
Peak intensity 7.8 cd/lm
LEDs/each optic 1
Light colour White
Required components:

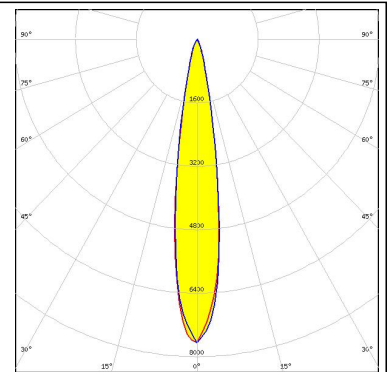

LED NVSxE21A
FWHM 10.0°
Efficiency 94 %
Peak intensity 17.5 cd/lm
LEDs/each optic 1
Light colour White
Required components:

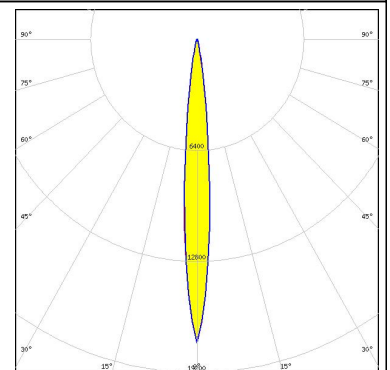

Osram Semiconductors

LED OSCONIQ P 3737 Flat
FWHM 11.0°
Efficiency 97 %
Peak intensity 15.3 cd/lm
LEDs/each optic 1
Light colour White
Required components:

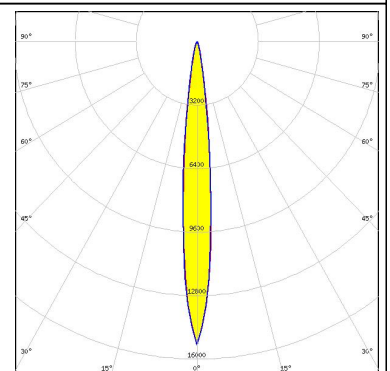

GENERAL INFORMATION:

NOTE: The typical beam angle will be changed by different color, chip size and chip position tolerance. The typical total beam angle is the full angle measured where the luminous intensity is half of the peak value.

MATERIALS:

As part of our continuous research and improvement processes, and to ensure the best possible quality and availability of our products, LEDiL reserves the right to change material grades without notice.

PRODUCT DATA USER AGREEMENT AND DISCLAIMER:

The measured data in the provided downloadable LEDiL Product Datasheets and Mechanical 2D-Drawings is rounded and provided as reference for planning. LEDiL Oy's optical specifications have been verified by conducting performance testing of the products in accordance with the company's quality system. The reported data are averaged results of multiple measurements with typical variation. LEDiL Oy reserves the right to without prior notification make changes and improvements to its products.

LEDiL Oy assumes neither warranty, nor guarantee nor any other liability of any kind for the contents and correctness of the provided data. The provided data has been generated with highest diligence but the provided data may in reality not represent the complete possible variation range of all intrinsic parameters. Therefore, in certain cases a deviation from the provided data could occur.

LEDiL Oy reserves the right to undertake technical changes of its products without further notification which could lead to changes in the provided data. LEDiL Oy assumes no liability of any kind for the possible deviation from any provided data or any other damage resulting from the usage of the provided data.

The user agrees to this disclaimer and user agreement with the download or usage of the provided files.

LEDiL Oy

Joensuunkatu 13
FI-24240 SALO
Finland

LEDiL Inc.

228 West Page Street
Suite D
Sycamore IL 60178
USA

Local sales and technical support

[www.ledil.com/
where_to_buy](http://www.ledil.com/where_to_buy)

Shipping locations

Salo, Finland
Hong Kong, China

Distribution Partners

[www.ledil.com/
where_to_buy](http://www.ledil.com/where_to_buy)

Компания «Life Electronics» занимается поставками электронных компонентов импортного и отечественного производства от производителей и со складов крупных дистрибьюторов Европы, Америки и Азии.

С конца 2013 года компания активно расширяет линейку поставок компонентов по направлению коаксиальный кабель, кварцевые генераторы и конденсаторы (керамические, пленочные, электролитические), за счёт заключения дистрибьюторских договоров

Мы предлагаем:

- Конкурентоспособные цены и скидки постоянным клиентам.
- Специальные условия для постоянных клиентов.
- Подбор аналогов.
- Поставку компонентов в любых объемах, удовлетворяющих вашим потребностям.
- Приемлемые сроки поставки, возможна ускоренная поставка.
- Доставку товара в любую точку России и стран СНГ.
- Комплексную поставку.
- Работу по проектам и поставку образцов.
- Формирование склада под заказчика.
- Сертификаты соответствия на поставляемую продукцию (по желанию клиента).
- Тестирование поставляемой продукции.
- Поставку компонентов, требующих военную и космическую приемку.
- Входной контроль качества.
- Наличие сертификата ISO.

В составе нашей компании организован Конструкторский отдел, призванный помогать разработчикам, и инженерам.

Конструкторский отдел помогает осуществить:

- Регистрацию проекта у производителя компонентов.
- Техническую поддержку проекта.
- Защиту от снятия компонента с производства.
- Оценку стоимости проекта по компонентам.
- Изготовление тестовой платы монтаж и пусконаладочные работы.



Тел: +7 (812) 336 43 04 (многоканальный)

Email: org@lifeelectronics.ru