

Product Description

Qorvo's TGS2354 is a Single-Pole, Double-Throw (SPDT) reflective switch fabricated on Qorvo's QGaN25 0.25um GaN on SiC production process.

Operating from 0.5 to 6GHz, the TGS2354 typically supports up to 40W input power handling at control voltages of 0/-40 V. This switch maintains low insertion loss of 0.8 dB or less, and greater than 25dB isolation making it ideal for high power switching applications across both defense and commercial platforms.

The TGS2354 is available in a small 1.397 x 1.58 mm die size and allows control voltage input from either side of the die. This, along with the minimal DC power consumption, allows for easy system integration.

Lead-free and RoHS compliant.

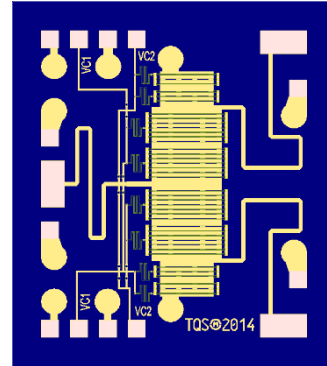

Product Features

- Frequency Range: 0.5 - 6 GHz
- Insertion Loss: ≤ 0.8 dB
- Power Handling: 46 dBm (P0.1dB)
- Return Loss: > 15 dB
- Isolation: > 26 dB
- Control Voltages: 0 V/-40 V (from either side of the MMIC)
- Switching Speed: < 50 nS
- Reflective Switch
- Die Dimensions: 1.397 mm x 1.580 mm x 0.10 mm

Performance is typical across frequency. Please reference electrical specification table and data plots for more details.

Block Diagram

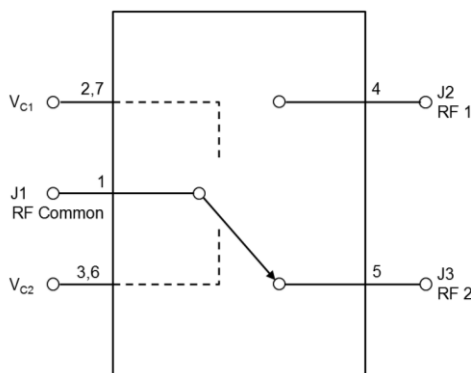

Applications

- Commercial and Military Radar
- Communications
- Electronic Warfare
- Test Instruments
- General Purpose
- High Power Switching

Ordering Information

Part No.	Description
TGS2354	0.5-6 GHz 40 Watt GaN Switch

Absolute Maximum Ratings

Parameter	Value
Control Voltage (V_C)	-50 V
Control Current (I_C)	-1.0 / +1.0 mA
Power Dissipation (CW)	15 W
RF Input Power (CW)	46.5 dBm
Mounting Temperature (30 sec)	320 °C
Storage Temperature	-55 to 150 °C

Operation of this device outside the parameter ranges given above may cause permanent damage. These are stress ratings only, and functional operation of the device at these conditions is not implied.

Recommended Operating Conditions

Parameter	Min	Typ	Max	Units
Frequency	0.5		6	GHz
Input Power Handling (CW)		46		dBm
Control Voltage		-40		V
Temperature Range	-40	25	+85	°C

Electrical specifications are measured at specified test conditions. Specifications are not guaranteed over all recommended operating conditions.

Electrical Specifications

Test conditions unless otherwise noted: $T_{BASE} = 25\text{ °C}$, $V_C = -40\text{V}$, CW Input Power

Parameter	Conditions	Min	Typical	Max	Units
Operational Frequency Range		0.5		6.0	GHz
P-0.1dB	CW Input Power		46		dBm
Control Current (I_C)			0.1		mA
Insertion Loss	On-State, 0.5-4 GHz		< 0.5		dB
	On-State, 4-8 GHz		< 0.8		
Input Return Loss – Common Port RL	On-State		> 15		dB
Output Return Loss – Switched Port RL	On-State		> 15		dB
Isolation	Off-State		> 26		dB
Output Return Loss – Isolated Port RL	Off-State		2.3		dB
Third Order IM Distortion			< -48		dBc
Switching Speed	10%-90, 90-10%, $V_C = -20\text{V}$		< 50		nS
Control Voltage			-40	-48	V
Insertion Loss Temperature Coefficient			0.003		dB/ °C

Thermal and Reliability Information

Parameter	Test Conditions	Value	Units
Thermal Resistance (θ_{JC}) ^(1,2)	$T_{BASE} = 85\text{ °C}$, $V_{C1} = 0\text{ V}$, $V_{C2} = -40\text{ V}$,	5.33	°C/W
Channel Temperature (T_{CH}) ^(1,2)	$P_{IN} = 40\text{ W}$, $P_{DISS} = 12\text{ W}$	149	°C

1. MMIC soldered to 40 mil thick Cu-Mo carrier plate using AuSn solder. Thermal resistance is determined from the channel to the back of the carrier plate (fixed 85 °C temp.).
2. Refer to the following document: [GaN Device Channel Temperature, Thermal Resistance, and Reliability Estimates](#)

Performance Plots – Small Signal

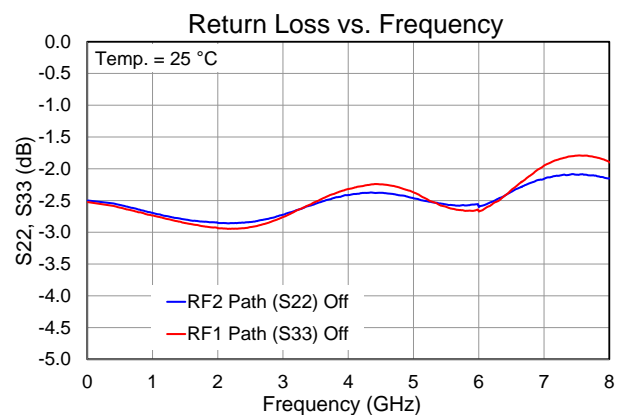
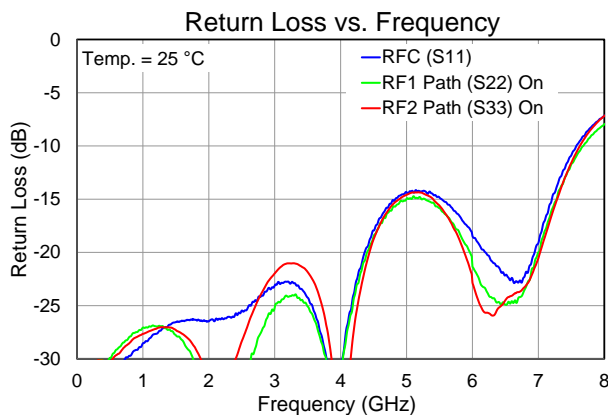
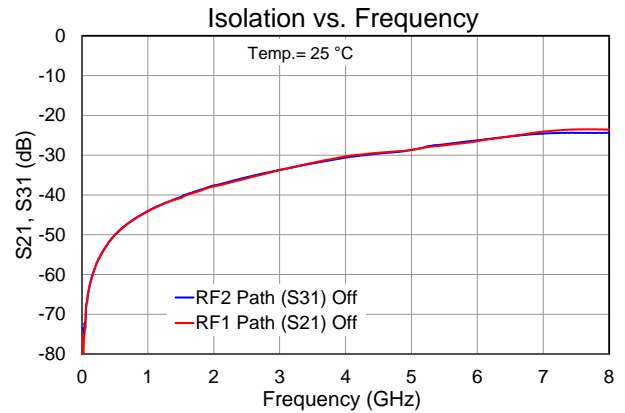
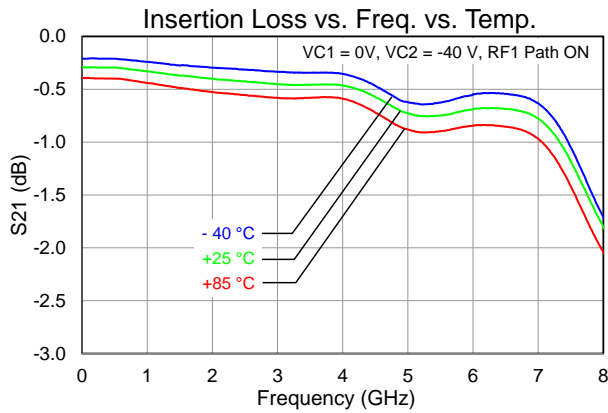
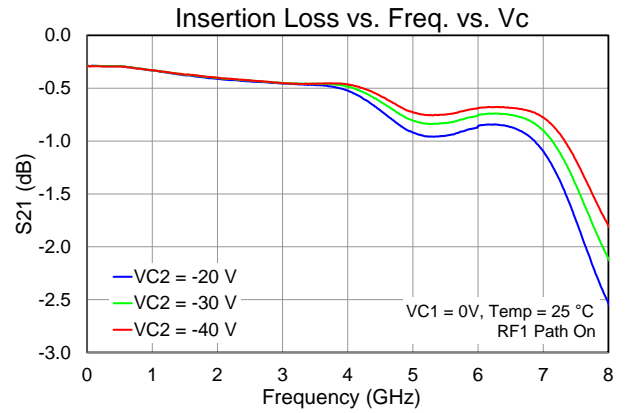
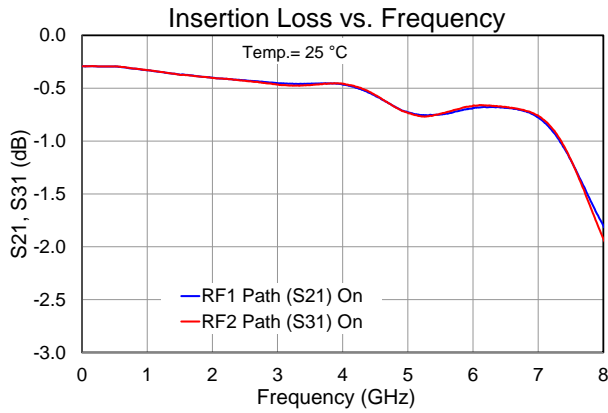

Performance Plots – Large Signal

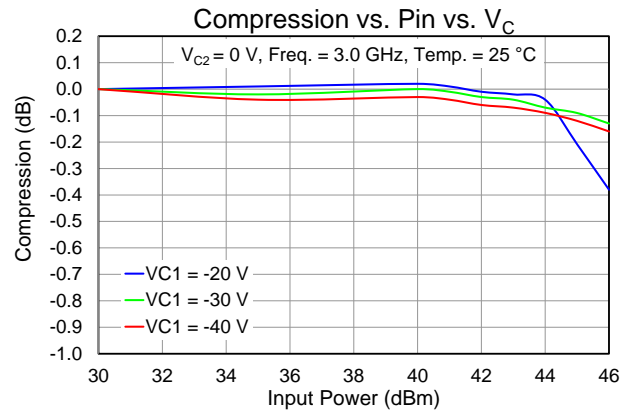
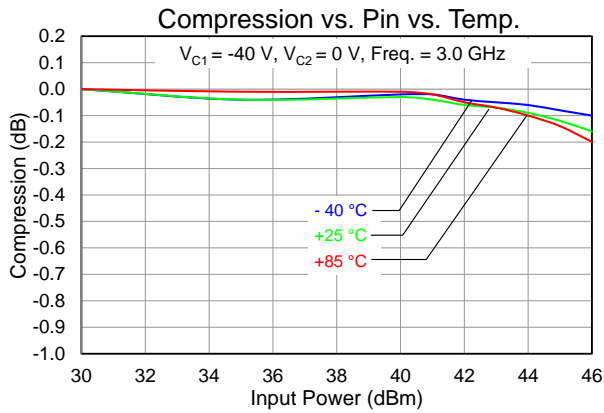
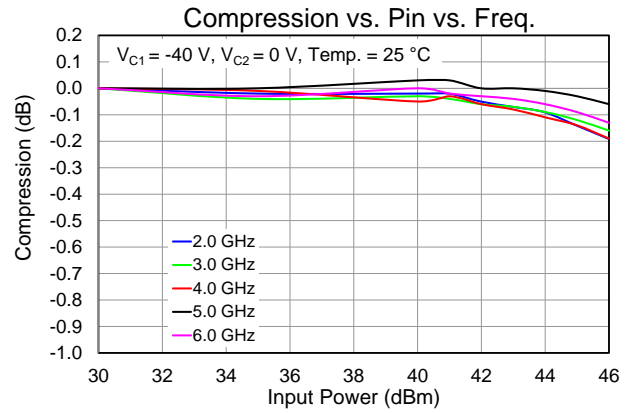
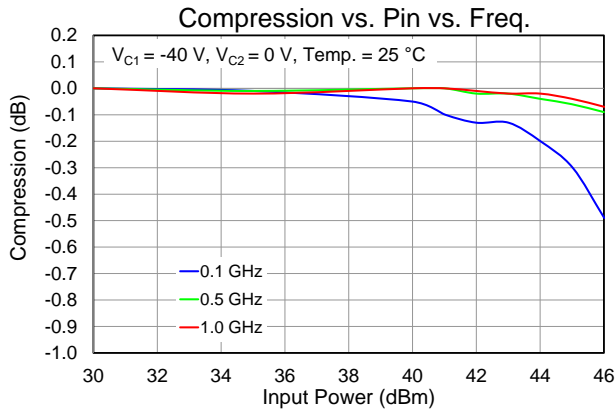

Performance Plots – Linearity

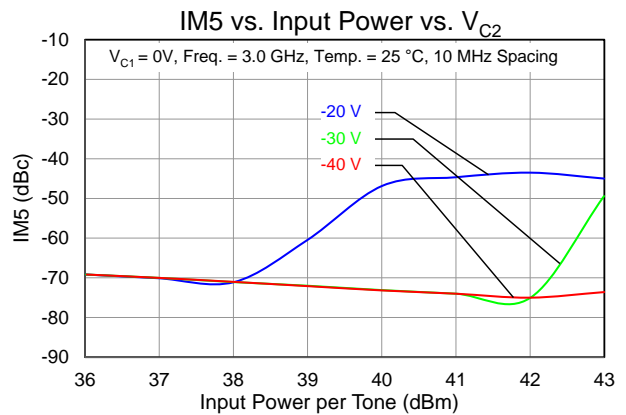
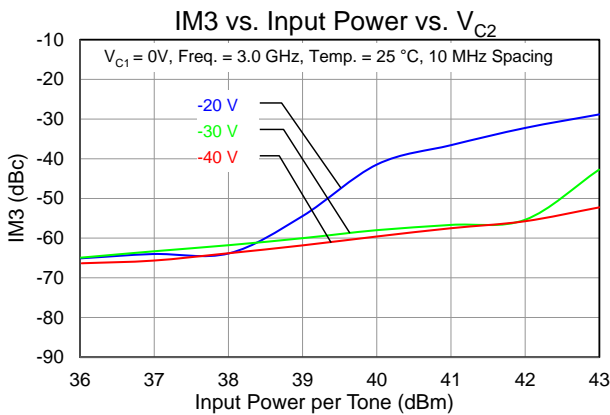
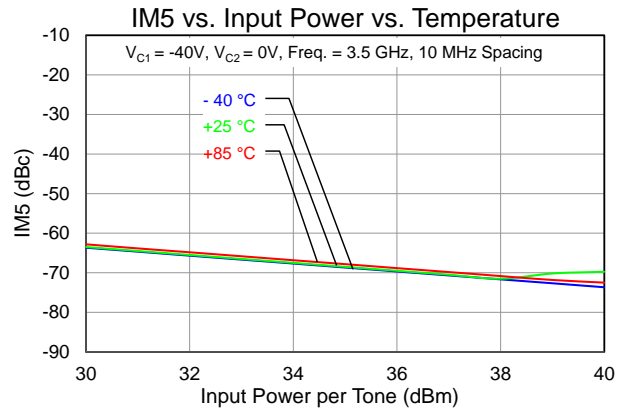
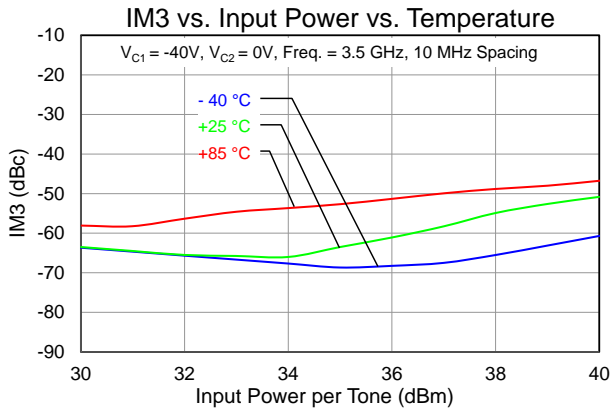
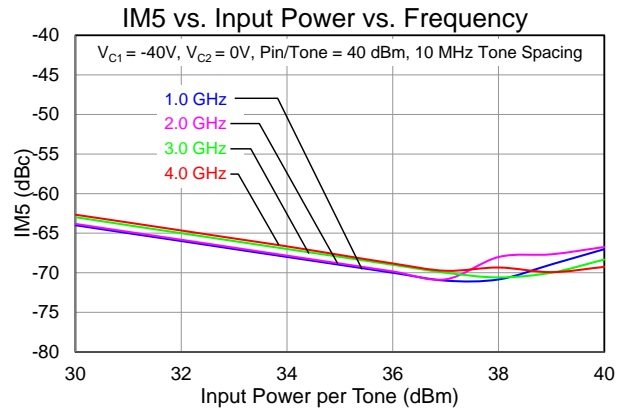
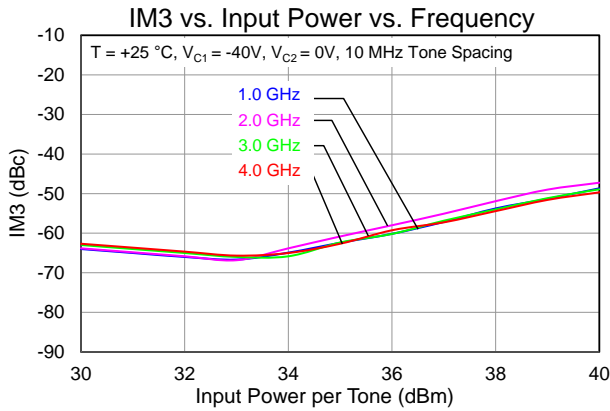

Applications Circuit

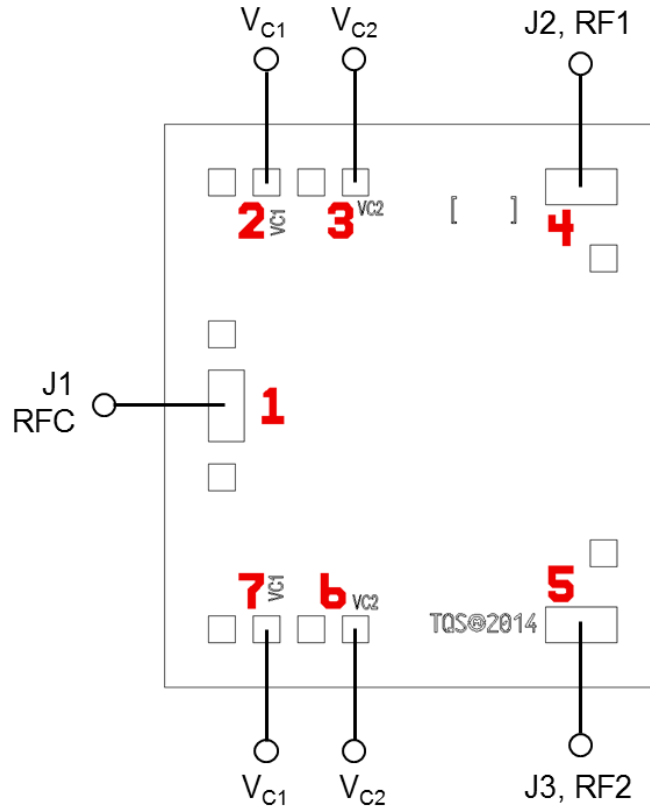

Notes:

DC blocking capacitors are required on all RF ports.

VC1 can be biased from either bond pad 2 or 7, and the non-biased bond pad can be left open.
 VC2 can be biased from either bond pad 3 or 6, and the non-biased bond pad can be left open.

This switch can be configured as a Single Pole, Single Throw (SPST) by terminating one unused RF switched port with a 50 Ohm load.

Function Table

RF Path	State	V _{c1}	V _{c2}
RFC to RF1	On-State (Insertion Loss)	0 V	-40 V
	Off-State (Isolation)	-40 V	0 V
RFC to RF2	On-State (Insertion Loss)	-40 V	0 V
	Off-State (Isolation)	0 V	-40 V

Evaluation Board (EVB) Layout Assembly

RF Layer is 0.010" thick Rogers Corp. RO4350B, $\epsilon_r = 3.48$. Metal layers are 0.5 oz. copper. The microstrip line at the connector interface is optimized for the Southwest Microwave end launch connector 1092-02A-5.

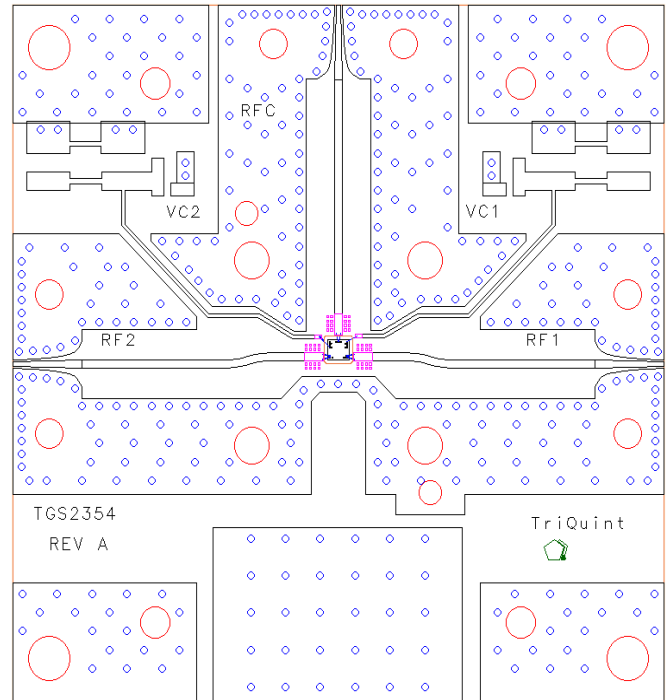

Mounting Detail

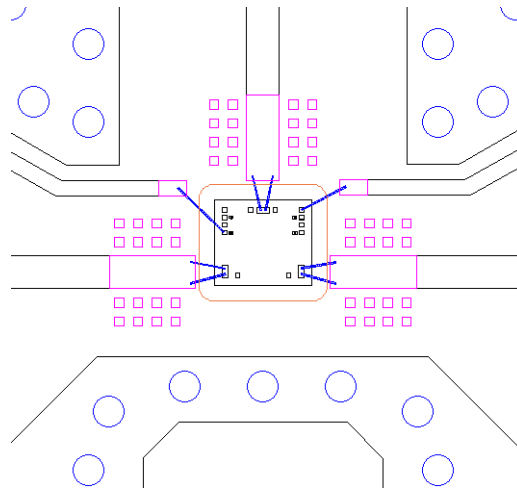

Note: MMIC die is mounted directly to carrier plate in the cutout of the EVB.

Mechanical Drawing and Bond Pad Description

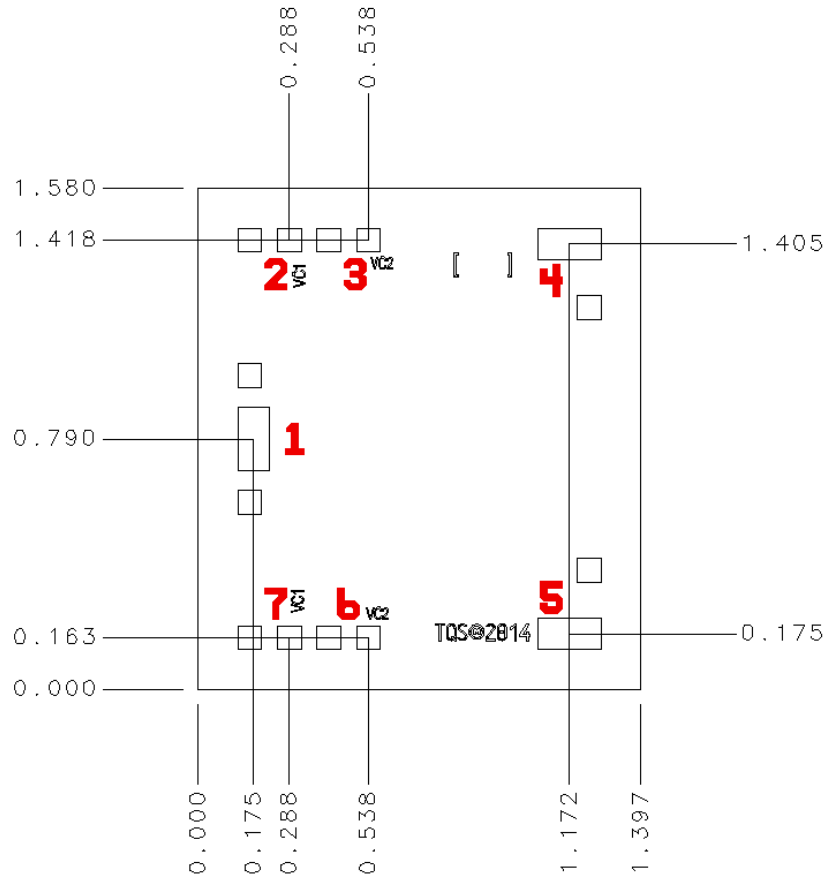

Unit: millimeters
 Thickness: 0.10
 Die x, y size tolerance: +/- 0.050
 Chip edge to bond pad dimensions are shown to center of pad

Pin No.	Symbol	Description	Pad Size (mm)
1	RFC	RF common port; matched to 50 Ω; DC coupled	0.100 x 0.200
2, 7	VC1	Control voltage 1	0.075 x 0.075
3, 6	VC2	Control voltage 2	0.075 x 0.075
4	RF1	RF switched port 1; matched to 50 Ω; DC coupled	0.200 x 0.100
5	RF2	RF switched port 2; matched to 50 Ω; DC coupled	0.200 x 0.100

Assembly Notes

Component placement and adhesive attachment assembly notes:

- Vacuum pencils and/or vacuum collets are the preferred method of pick up.
- Air bridges must be avoided during placement.
- The force impact is critical during auto placement.
- Organic attachment (i.e., conductive epoxy) can be used in low-power applications.
- Curing should be done in a convection oven; proper exhaust is a safety concern.

Reflow process assembly notes:

- Use AuSn (80/20) solder and limit exposure to temperatures above 300 °C to 3–4 minutes, maximum.
- An alloy station or conveyor furnace with reducing atmosphere should be used.
- Do not use any kind of flux.
- Coefficient of thermal expansion matching is critical for long-term reliability.
- Devices must be stored in a dry nitrogen atmosphere.

Interconnect process assembly notes:

- Thermosonic ball bonding is the preferred interconnect technique.
- Force, time, and ultrasonic are critical parameters.
- Aluminum wire should not be used.
- Devices with small pad sizes should be bonded with 0.0007-inch wire.

Handling Precautions

Parameter	Rating	Standard	 Caution! ESD-Sensitive Device
ESD – Human Body Model (HBM)	1A	ESDA / JEDEC JS-001	

Solderability

Use only AuSn (80/20) solder and limit exposure to temperatures above 300 °C to 3-4 minutes, maximum.

RoHS Compliance

This product is compliant with the 2011/65/EU RoHS directive (Restrictions on the Use of Certain Hazardous Substances in Electrical and Electronic Equipment), as amended by Directive 2015/863/EU. This product also has the following attributes:

- Lead Free
- Halogen Free (Chlorine, Bromine)
- Antimony Free
- TBBP-A (C₁₅H₁₂Br₄O₂) Free
- PFOS Free
- SVHC Free
- Qorvo Green

Contact Information

For the latest specifications, additional product information, worldwide sales and distribution locations:

Tel: 1-844-890-8163

Web: www.qorvo.com

Email: customer.support@qorvo.com

For technical questions and application information: **Email:** appsupport@qorvo.com

Important Notice

The information contained herein is believed to be reliable; however, Qorvo makes no warranties regarding the information contained herein and assumes no responsibility or liability whatsoever for the use of the information contained herein. All information contained herein is subject to change without notice. Customers should obtain and verify the latest relevant information before placing orders for Qorvo products. The information contained herein or any use of such information does not grant, explicitly or implicitly, to any party any patent rights, licenses, or any other intellectual property rights, whether with regard to such information itself or anything described by such information. **THIS INFORMATION DOES NOT CONSTITUTE A WARRANTY WITH RESPECT TO THE PRODUCTS DESCRIBED HEREIN, AND QORVO HEREBY DISCLAIMS ANY AND ALL WARRANTIES WITH RESPECT TO SUCH PRODUCTS WHETHER EXPRESS OR IMPLIED BY LAW, COURSE OF DEALING, COURSE OF PERFORMANCE, USAGE OF TRADE OR OTHERWISE, INCLUDING THE IMPLIED WARRANTIES OF MERCHANTABILITY AND FITNESS FOR A PARTICULAR PURPOSE.**

Without limiting the generality of the foregoing, Qorvo products are not warranted or authorized for use as critical components in medical, life-saving, or life-sustaining applications, or other applications where a failure would reasonably be expected to cause severe personal injury or death.

Copyright 2018 © Qorvo, Inc. | Qorvo is a registered trademark of Qorvo, Inc.

Компания «Life Electronics» занимается поставками электронных компонентов импортного и отечественного производства от производителей и со складов крупных дистрибьюторов Европы, Америки и Азии.

С конца 2013 года компания активно расширяет линейку поставок компонентов по направлению коаксиальный кабель, кварцевые генераторы и конденсаторы (керамические, пленочные, электролитические), за счёт заключения дистрибьюторских договоров

Мы предлагаем:

- Конкурентоспособные цены и скидки постоянным клиентам.
- Специальные условия для постоянных клиентов.
- Подбор аналогов.
- Поставку компонентов в любых объемах, удовлетворяющих вашим потребностям.
- Приемлемые сроки поставки, возможна ускоренная поставка.
- Доставку товара в любую точку России и стран СНГ.
- Комплексную поставку.
- Работу по проектам и поставку образцов.
- Формирование склада под заказчика.
- Сертификаты соответствия на поставляемую продукцию (по желанию клиента).
- Тестирование поставляемой продукции.
- Поставку компонентов, требующих военную и космическую приемку.
- Входной контроль качества.
- Наличие сертификата ISO.

В составе нашей компании организован Конструкторский отдел, призванный помогать разработчикам, и инженерам.

Конструкторский отдел помогает осуществить:

- Регистрацию проекта у производителя компонентов.
- Техническую поддержку проекта.
- Защиту от снятия компонента с производства.
- Оценку стоимости проекта по компонентам.
- Изготовление тестовой платы монтаж и пусконаладочные работы.



Тел: +7 (812) 336 43 04 (многоканальный)

Email: org@lifeelectronics.ru