

SWITCHING REGULATOR CONTROL IC

■ GENERAL DESCRIPTION

The NJM2377 is high speed switching regulator control IC which can operate at low voltage.

The NJM2377 consists of low power oscillation circuit, high precision reference, wide band error amplifier, under voltage lockout circuit, and a totem pole output circuit; which can drive an external Bipolar transistor directly.

The NJM2377 is suitable for any portable system, TFT panel to note PC and especially power supply at video CD.

■ PACKAGE OUTLINE

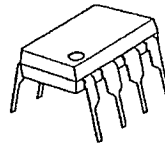

NJM2377D



NJM2377M



NJM2377V

■ FEATURES

- PWM Type Switching Regulator Control
- Operating Voltage (2.7~18V)
- Wide Oscillator Range (10~500kHz)
- ON/OFF Maximum Duty Cycle (Ton:Toff=9:1)
- Totem Pole Output
- Soft-Start Function
- Under Voltage Lockouts (U. V. L. O.)
- Bipolar Technology
- Package Outline DIP8, DMP8, SSOP8

■ BLOCK DIAGRAM

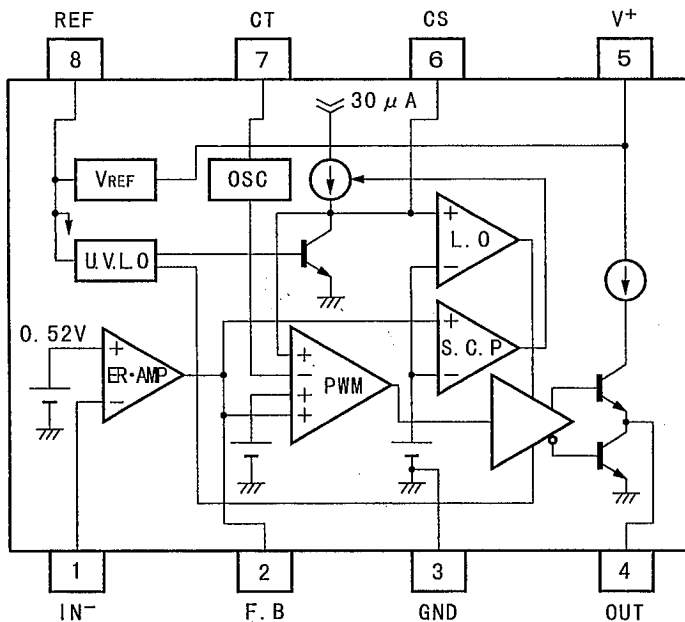

- PIN FUNCTION
1. IN<sup>-</sup>
  2. F. B
  3. GND
  4. OUT
  5. V<sup>+</sup>
  6. CS
  7. CT
  8. REF

■ ABSOLUTE MAXIMUM RATINGS (Ta=25°C)

PARAMETER	SYMBOL	RATINGS	UNIT
Input Voltage	V <sup>+</sup>	18	V
Reference Output Current	I <sub>o</sub>	±50	mA
Power Dissipation	P <sub>D</sub>	(DIP8) 700 (DMP8) 300 (SSOP8) 250	mW
Operating Temperature Range	T <sub>OPR</sub>	-40~+85	°C
Storage Temperature Range	T <sub>STG</sub>	-50~+150	°C

■ RECOMMENDED OPERATING CONDITIONS (V<sup>+</sup>=3V, Ta=25°C)

PARAMETER	SYMBOL	MIN.	MAX.	UNIT
Operating Voltage	V <sup>+</sup>	2.7	18	V
Feed Back Resistor	R <sub>NF</sub>	100	—	k Ω
Oscillator Timing Capacitor	C <sub>T</sub>	220	22,000	p F
Oscillator Timing Resistor	R <sub>T</sub>	5	100	k Ω
Oscillation Frequency	f <sub>osc</sub>	10	500	k H z

■ ELECTRICAL CHARACTERISTICS ( $V^+=3V$ ,  $R_T=39k\Omega$ ,  $C_T=470pF$ ,  $T_a=25^\circ C$ )

REFERENCE VOLTAGE BLOCK

PARAMETER	SYMBOL	TEST CONDITION	MIN.	TYP.	MAX.	UNIT
Output Voltage	$V_{REF}$	$I_{OR}=1mA$	1.47	1.50	1.53	V
Line Regulation	$\Delta V_o - V_{IN}$	$V^+=2.7\sim 18V$ , $I_{OR}=1mA$	—	3.8	11.5	mV
Load Regulation	$\Delta V_o - I_o$	$I_{OR}=0.1\sim 5.0mA$	—	5	30	mA

OSCILLATOR BLOCK

PARAMETER	SYMBOL	TEST CONDITION	MIN.	TYP.	MAX.	UNIT
Oscillation Frequency	$f_{osc}$	$C_T=470pA$ , $R_T=39k\Omega$	80	100	120	kHz
Oscillate Fluctuations1 (Line Fluctuations)	$f_{dv}$	$V^+=2.7\sim 18V$ , $I_{OR}=1mA$	—	1	—	%
Oscillate Fluctuations2 (Temp. Fluctuations)	$f_{dt}$	$T_a=-40\sim +85^\circ C$	—	5	—	%

ERROR AMPLIFIER BLOCK

PARAMETER	SYMBOL	TEST CONDITION	MIN.	TYP.	MAX.	UNIT
Reference Voltage	$V_B$		0.51	0.52	0.53	V
Input Bias Current	$I_B$		—	5	100	nA
Open Loop Gain	$A_v$		—	90	—	dB
Gain Band width Product	$G_B$		—	1.0	—	MHz
Maximum Output Voltage (F. B Pin)	$V_{OM+}$	$R_{NF}=100k\Omega$ , $I_{N-} Pin=0V$	1.9	2.2	2.4	V
	$V_{OM-}$	$R_{NF}=100k\Omega$ , $I_{N-} Pin=1V$	—	—	200	mA
Output Source Current (F. B Pin)	$I_{OM+}$	$V_{OM}=1V$ , $I_{N-} Pin=0V$	40	85	200	$\mu A$

PWM COMPARABLE BLOCK

PARAMETER	SYMBOL	TEST CONDITION	MIN.	TYP.	MAX.	UNIT
Input Bias Voltage (F. B Pin)	$V_{TH0}$	duty·cycle=0%	—	0.45	0.55	V
Input Threshold Voltage (F. B Pin)	$V_{TH80}$	duty·cycle=80%	—	1.05	—	V
Maximum Duty Cycle	$\alpha M$	F. B Pin=1.2V $C_T=470pF$ , $R_T=39k\Omega$	80	90	—	%

SOFT START CIRCUIT BLOCK

PARAMETER	SYMBOL	TEST CONDITION	MIN.	TYP.	MAX.	UNIT
Input Bias Current (GS Pin)	$I_{BCS}$		—	250	650	nA
Input Threshold Voltage (GS Pin)	$V_{THCS0}$	duty·cycle=0% F. B Pin=1.2V	—	0.25	0.35	V
Input Threshold Voltage (GS Pin)	$V_{THCS80}$	duty·cycle=80% F. B Pin=1.2V	—	0.79	—	V

6

■ ELECTRICAL CHARACTERISTICS ( $V^+=3V$ ,  $R_T=39k\Omega$ ,  $C_T=470pF$ ,  $T_a=25^\circ C$ )

SHORT CIRCUIT PROTECTION

PARAMETER	SYMBOL	TEST CONDITION	MIN.	TYP.	MAX.	UNIT
Input Threshold Voltage (F.B Pin)	$V_{THPC}$		1.30	1.50	1.80	V
Charge Current (CS Pin)	$I_{CHG}$	CS Pin=0V, F.B Pin=2V	10	30	50	$\mu A$
Latch mode Threshold Voltage (CS Pin)	$V_{THLA}$		1.20	1.50	1.80	V

UNDER VOLTAGE LOCKOUT

PARAMETER	SYMBOL	TEST CONDITION	MIN.	TYP.	MAX.	UNIT
ON Threshold Voltage	$V_{THON}$		—	1.95	—	V
OFF Threshold Voltage	$V_{THOFF}$		—	1.78	—	V
Hysteresis Voltage	$V_{HYS}$		60	170	—	mV

OUTPUT BLOCK

PARAMETER	SYMBOL	TEST CONDITION	MIN.	TYP.	MAX.	UNIT
H-Output Voltage (OUT Pin)	$V_{OH}$	$R_L=10k\Omega$	1.7	2.0	—	V
L-Output Voltage (OUT Pin)	$V_{OL}$	Output Sink Current=20mA	—	0.25	0.65	V
Output Source Current (OUT Pin)	$I_{SOURCE}$	OUT Pin=0V	23	35	—	mA

GENERAL CHARACTERISTIC

PARAMETER	SYMBOL	TEST CONDITION	MIN.	TYP.	MAX.	UNIT
Quiescent Current	$I_{CCLA}$	Latch Mode, CS Pin=1.8V	—	1.7	2.4	mA
Average Quiescent Current	$I_{CCAV}$	$R_L=\infty$ , duty-cycle=50%	—	5.0	6.8	mA

6

■ TYPICAL APPLICATION

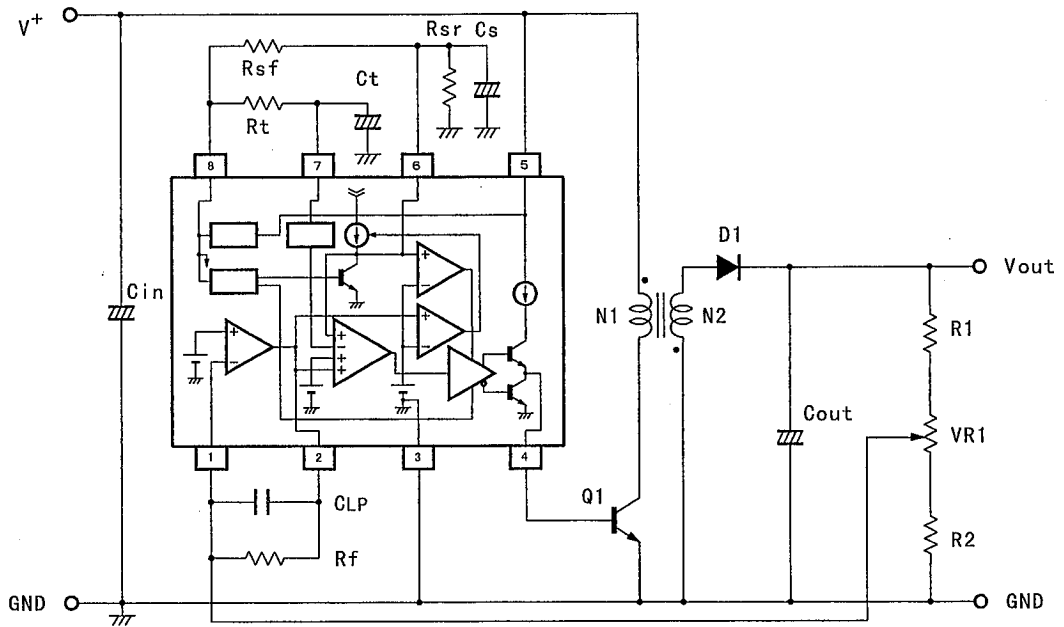

## TYPICAL CHARACTERISTICS

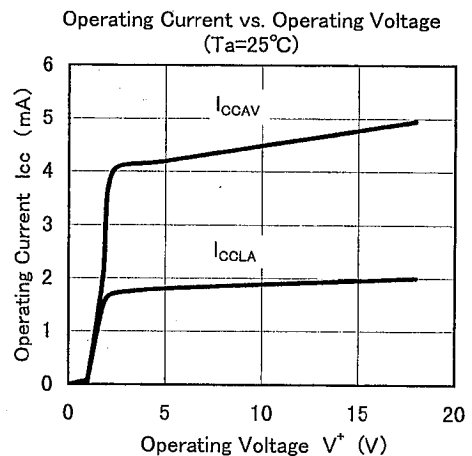
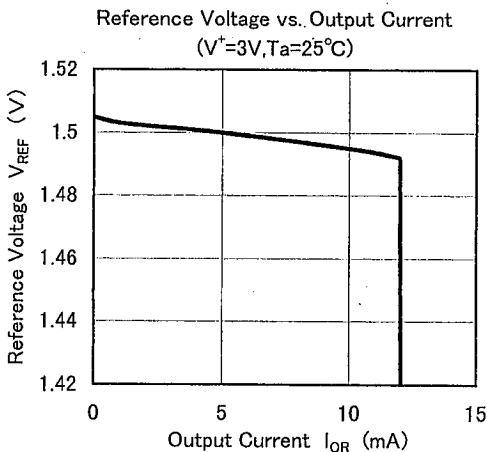
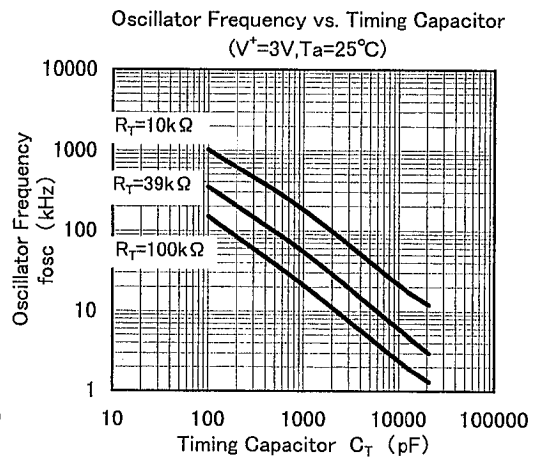
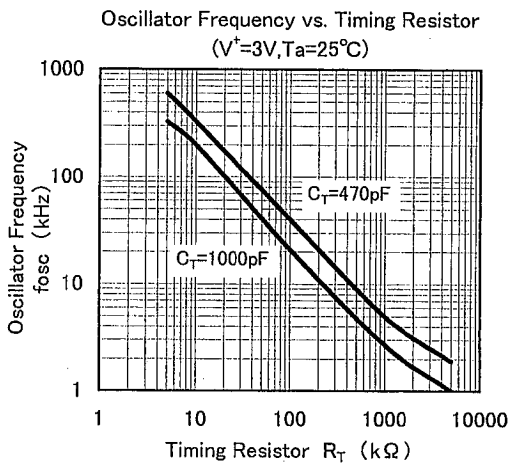
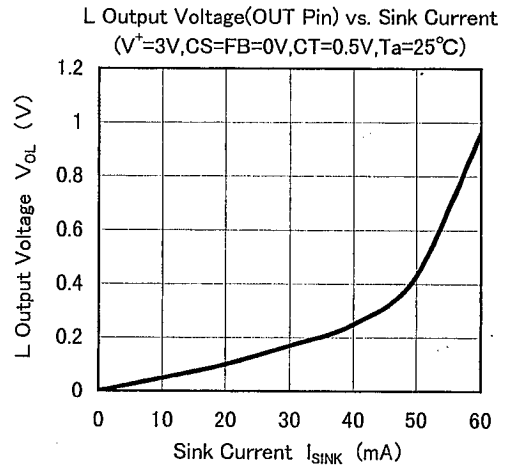
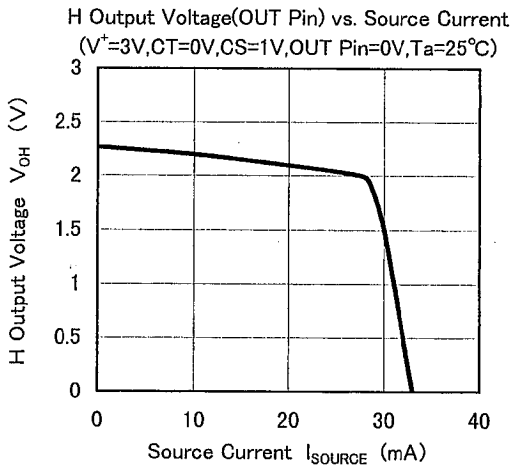

■ TYPICAL CHARACTERISTICS

Maximum Duty Cycle vs. Oscillator Frequency  
( $V^+ = 3V$ )

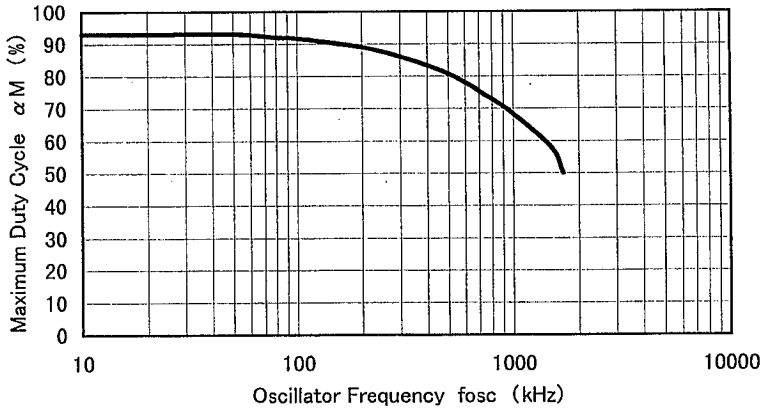

Duty Cycle vs. CS Pin Voltage  
( $V^+ = 3V$ )

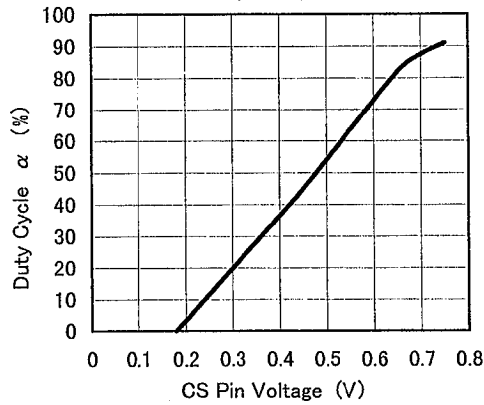

Quiescent Current (Latch Mode) vs. Temperature  
( $V^+ = 3V, CS = 1.8V$ )

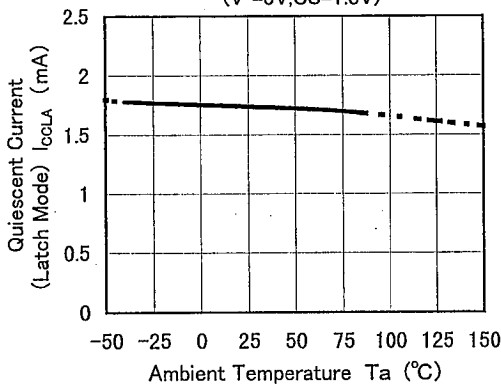

Average Quiescent Current vs. Temperature  
( $V^+ = 3V, R_L = \infty, \text{duty cycle} = 50\%$   
 $R_T = 39k\Omega, C_T = 470pF$ )

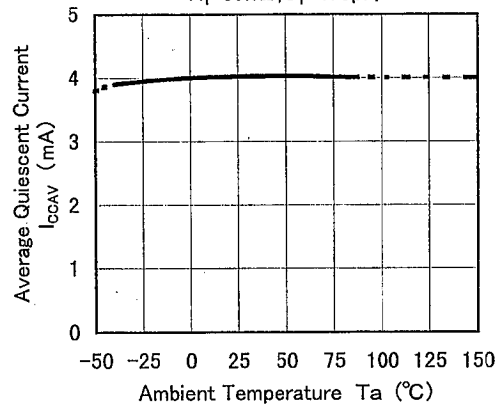

6

## TYPICAL CHARACTERISTICS

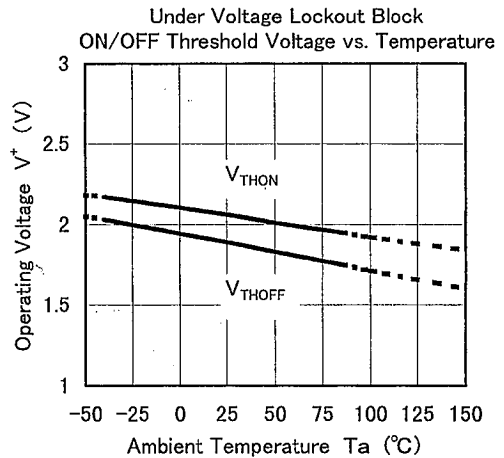
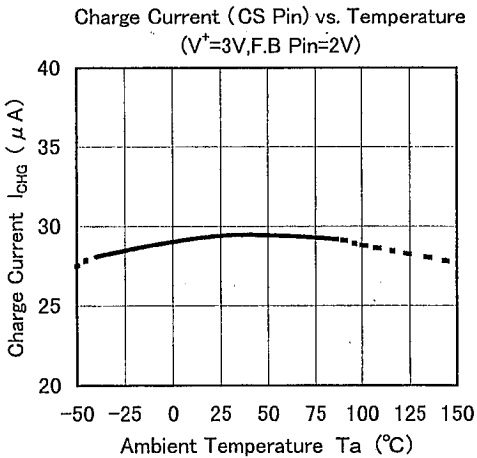
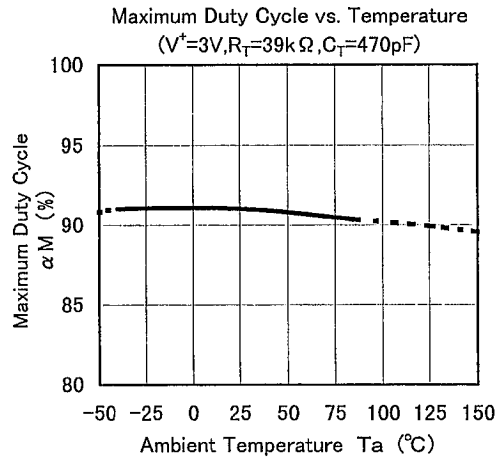
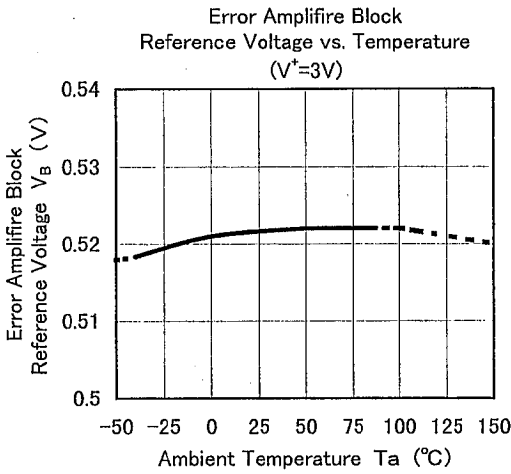
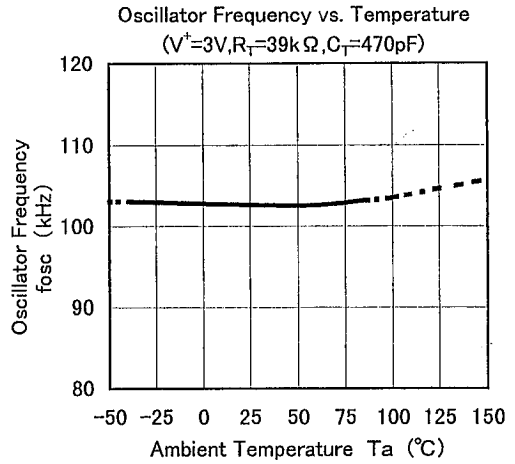
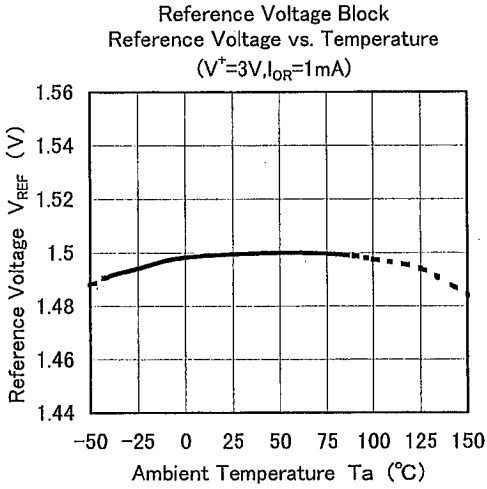



■ TYPICAL CHARACTERISTICS

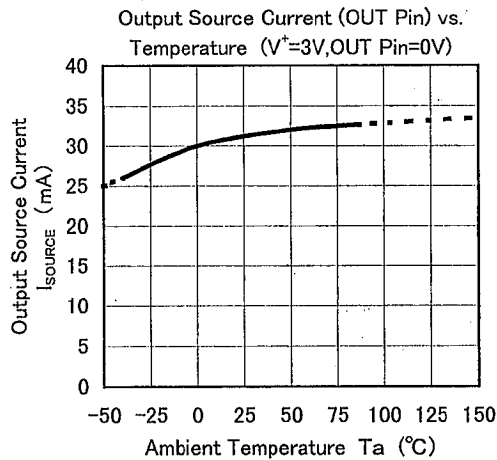
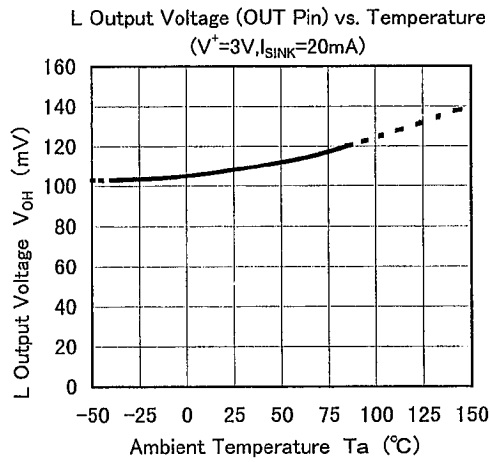
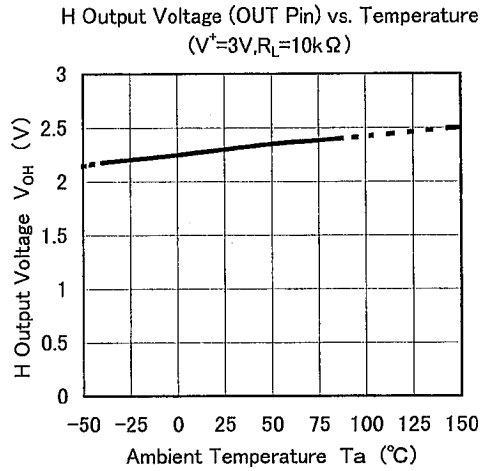

## MEMO

[CAUTION]

The specifications on this databook are only given for information, without any guarantee as regards either mistakes or omissions. The application circuits in this databook are described only to show representative usages of the product and not intended for the guarantee or permission of any right including the industrial rights.

Компания «Life Electronics» занимается поставками электронных компонентов импортного и отечественного производства от производителей и со складов крупных дистрибьюторов Европы, Америки и Азии.

С конца 2013 года компания активно расширяет линейку поставок компонентов по направлению коаксиальный кабель, кварцевые генераторы и конденсаторы (керамические, пленочные, электролитические), за счёт заключения дистрибьюторских договоров

Мы предлагаем:

- Конкурентоспособные цены и скидки постоянным клиентам.
- Специальные условия для постоянных клиентов.
- Подбор аналогов.
- Поставку компонентов в любых объемах, удовлетворяющих вашим потребностям.
- Приемлемые сроки поставки, возможна ускоренная поставка.
- Доставку товара в любую точку России и стран СНГ.
- Комплексную поставку.
- Работу по проектам и поставку образцов.
- Формирование склада под заказчика.
- Сертификаты соответствия на поставляемую продукцию (по желанию клиента).
- Тестирование поставляемой продукции.
- Поставку компонентов, требующих военную и космическую приемку.
- Входной контроль качества.
- Наличие сертификата ISO.

В составе нашей компании организован Конструкторский отдел, призванный помогать разработчикам, и инженерам.

Конструкторский отдел помогает осуществить:

- Регистрацию проекта у производителя компонентов.
- Техническую поддержку проекта.
- Защиту от снятия компонента с производства.
- Оценку стоимости проекта по компонентам.
- Изготовление тестовой платы монтаж и пусконаладочные работы.



Тел: +7 (812) 336 43 04 (многоканальный)  
Email: [org@lifeelectronics.ru](mailto:org@lifeelectronics.ru)