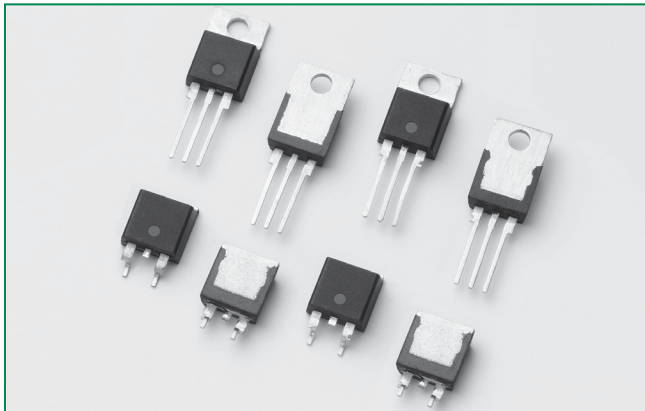



**Sxx20x & Sxx25x Series**

RoHS



**Agency Approval**

Agency	Agency File Number
	L Package: E71639

**Main Features**

Symbol	Value	Unit
$I_{T(RMS)}$	20 & 25	A
$V_{DRM}/V_{RRM}$	400 to 1000	V
$I_{GT}$	30 to 35	mA

**Additional Information**



**Datasheet**



**Resources**



**Samples**

**Absolute Maximum Ratings – 20A SCR**

Symbol	Parameter	Test Conditions	Value	Unit
$I_{T(RMS)}$	RMS on-state current	$T_c = 80^\circ\text{C}$	20	A
$I_{T(AV)}$	Average on-state current	Sxx20x $T_c = 80^\circ\text{C}$	12.8	A
$I_{TSM}$	Peak non-repetitive surge current	single half cycle; $f = 50\text{Hz}$ ; $T_j(\text{initial}) = 25^\circ\text{C}$	255	A
		single half cycle; $f = 60\text{Hz}$ ; $T_j(\text{initial}) = 25^\circ\text{C}$	300	
$I^2t$	$I^2t$ Value for fusing	$t_p = 8.3 \text{ms}$	374	$\text{A}^2\text{s}$
$di/dt$	Critical rate of rise of on-state current	$f = 60\text{Hz}$ ; $T_j = 125^\circ\text{C}$	125	$\text{A}/\mu\text{s}$
$I_{GM}$	Peak gate current	$T_j = 125^\circ\text{C}$	3	A
$P_{G(AV)}$	Average gate power dissipation	$T_j = 125^\circ\text{C}$	0.6	W
$T_{stg}$	Storage temperature range		-40 to 150	$^\circ\text{C}$
$T_j$	Operating junction temperature range		-40 to 125	$^\circ\text{C}$

**Description**

Excellent unidirectional switches for phase control applications such as heating and motor speed controls. Standard phase control SCRs are triggered with few milliamperes of current at less than 1.5V potential.

**Features & Benefits**

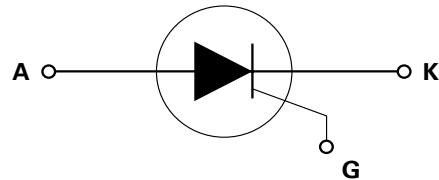
- RoHS compliant
- Glass – passivated junctions
- Voltage capability up to 1000 V
- Surge capability up to 350 A

**Applications**

Typical applications are AC solid-state switches, industrial power tools, exercise equipment, white goods and commercial appliances.

Internally constructed isolated packages are offered for ease of heat sinking with highest isolation voltage.

**Schematic Symbol**



**Absolute Maximum Ratings — 25A SCR**

Symbol	Parameter	Test Conditions	Value	Unit	
$I_{T(RMS)}$	RMS on-state current	Sxx25L: $T_c = 75^\circ\text{C}$	25	A	
		Sxx25R/Sxx25N: $T_c = 100^\circ\text{C}$			
$I_{T(AV)}$	Average on-state current	Sxx25L	$T_c = 75^\circ\text{C}$	16.0	A
		Sxx25R/Sxx25N	$T_c = 100^\circ\text{C}$		
$I_{TSM}$	Peak non-repetitive surge current	single half cycle; $f = 50\text{Hz}$ ; $T_J$ (initial) = $25^\circ\text{C}$	300	A	
		single half cycle; $f = 60\text{Hz}$ ; $T_J$ (initial) = $25^\circ\text{C}$	350		
$I^2t$	$I^2t$ Value for fusing	$t_p = 8.3 \text{ms}$	510	$\text{A}^2\text{s}$	
$di/dt$	Critical rate of rise of on-state current	$f = 60\text{Hz}$ ; $T_J = 125^\circ\text{C}$	150	$\text{A}/\mu\text{s}$	
$I_{GM}$	Peak gate current	$T_J = 125^\circ\text{C}$	3.5	A	
$P_{G(AV)}$	Average gate power dissipation	$T_J = 125^\circ\text{C}$	0.8	W	
$T_{stg}$	Storage temperature range		-40 to 150	$^\circ\text{C}$	
$T_J$	Operating junction temperature range		-40 to 125	$^\circ\text{C}$	

**Electrical Characteristics ( $T_J = 25^\circ\text{C}$ , unless otherwise specified)**

Symbol	Test Conditions	Value		Unit	
		Sxx20L	Sxx25x		
$I_{GT}$	$V_D = 12\text{V}$ ; $R_L = 30\Omega$	MAX.	30	35	mA
		MIN.	1	1	
$V_{GT}$		MAX.	1.5		V
$dv/dt$	$V_D = V_{DRM}$ ; gate open; $T_J = 100^\circ\text{C}$	400V	450		V/ $\mu\text{s}$
		600V	425		
		800V	400		
		1000V	MIN.	200	
	$V_D = V_{DRM}$ ; gate open; $T_J = 125^\circ\text{C}$	400V	350		
		600V	325		
800V		300			
$V_{GD}$	$V_D = V_{DRM}$ ; $R_L = 3.3 \text{k}\Omega$ ; $T_J = 125^\circ\text{C}$	MIN.	0.2		V
$I_H$	$I_T = 400\text{mA}$ (initial)	MAX.	40	50	mA
$t_g$	(1)	MAX.	35		$\mu\text{s}$
$t_{gt}$	$I_G = 2 \times I_{GT}$ ; $\text{PW} = 15\mu\text{s}$ ; $I_T = 40\text{A}$	TYR.	2		$\mu\text{s}$

Notes :  
 xx = voltage, x = package  
 (1)  $I_T = 2\text{A}$ ;  $t_g = 50\mu\text{s}$ ;  $dv/dt = 5\text{V}/\mu\text{s}$ ;  $di/dt = 30\text{A}/\mu\text{s}$

**Static Characteristics**

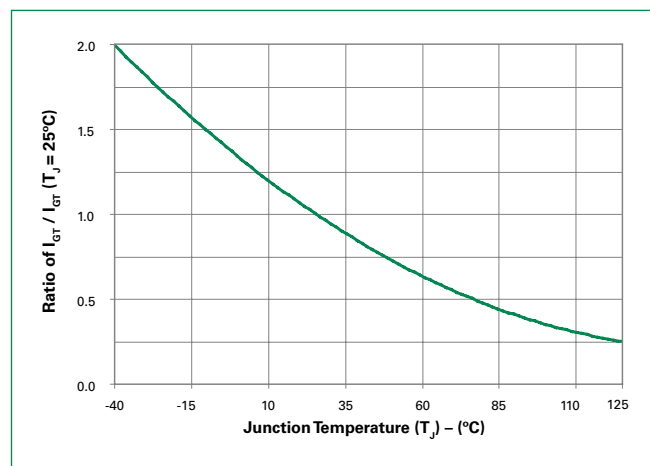
Symbol	Test Conditions			Value	Unit	
$V_{TM}$	20A Device $I_T = 40A$ ; $t_p = 380\mu s$			MAX.	1.6	V
	25A Device $I_T = 50A$ ; $t_p = 380\mu s$					
$I_{DRM} / I_{RRM}$	$V_{DRM} / V_{RRM}$	$T_J = 25^\circ C$	400 – 600V	MAX.	10	$\mu A$
			800 – 1000V		20	
		$T_J = 100^\circ C$	400 – 600V		500	
			800V		1000	
			1000V		3000	
		$T_J = 125^\circ C$	400 – 600V		1000	
			800V		2000	

**Thermal Resistances**

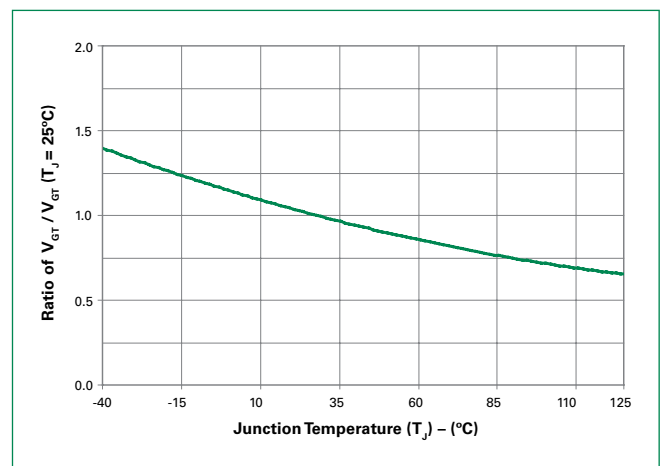
Symbol	Parameter		Value	Unit
$R_{\theta(J-C)}$	Junction to case (AC)	Sxx25R / Sxx25N	1.0	$^\circ C/W$
		Sxx20L	2.4	
		Sxx25L	2.35	
$R_{\theta(J-A)}$	Junction to ambient	Sxx25R	40	$^\circ C/W$
		Sxx20L / Sxx25L	50	

Note: xx = voltage

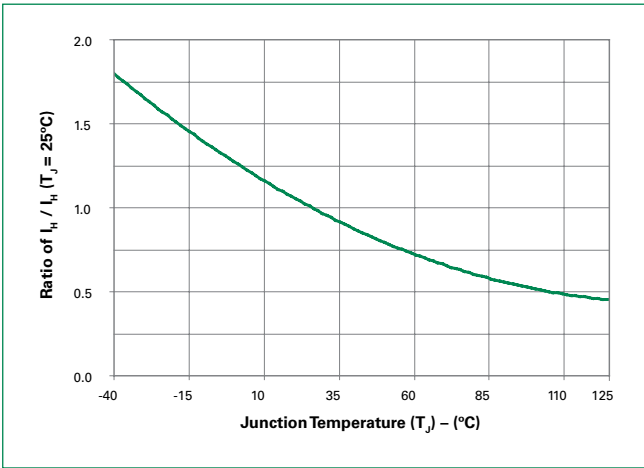
**Figure 1: Normalized DC Gate Trigger Current vs. Junction Temperature**



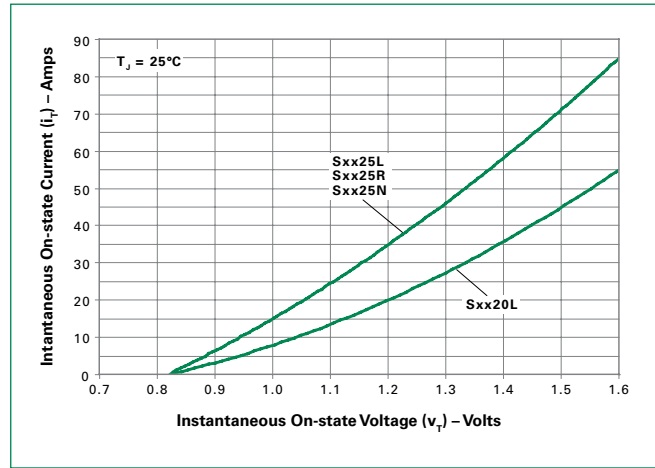
**Figure 2: Normalized DC Gate Trigger Voltage vs. Junction Temperature**



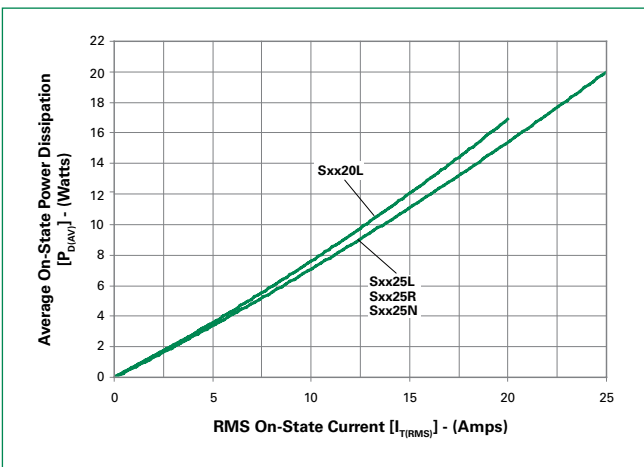
**Figure 3: Normalized DC Holding Current vs. Junction Temperature**



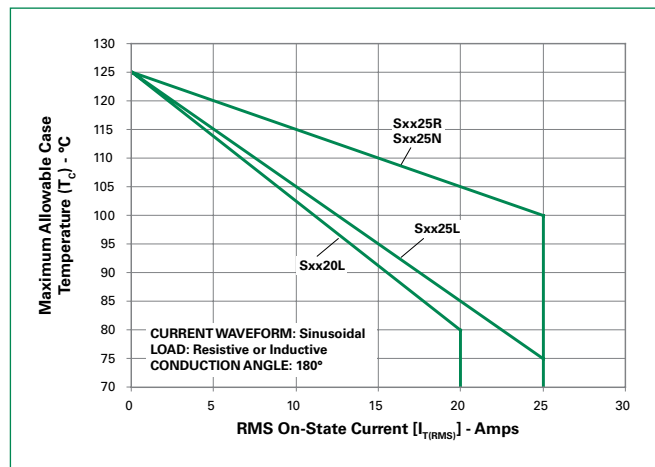
**Figure 4: On-State Current vs. On-State Voltage (Typical)**



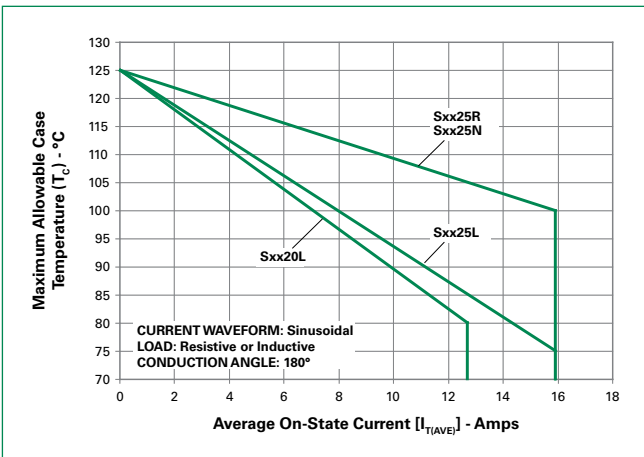
**Figure 5: Power Dissipation (Typical) vs. RMS On-State Current**



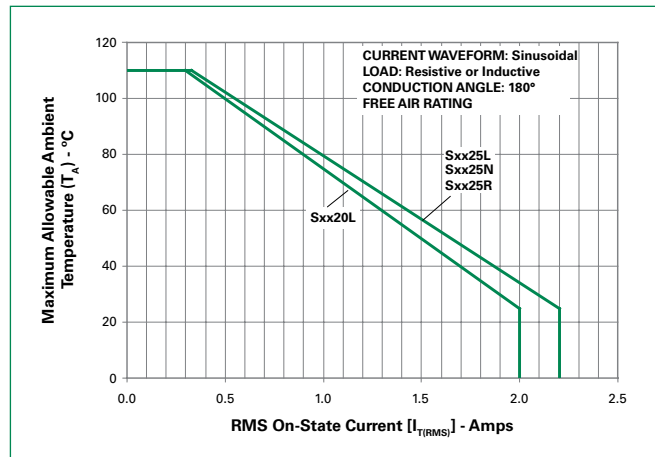
**Figure 6: Maximum Allowable Case Temperature vs. RMS On-State Current**



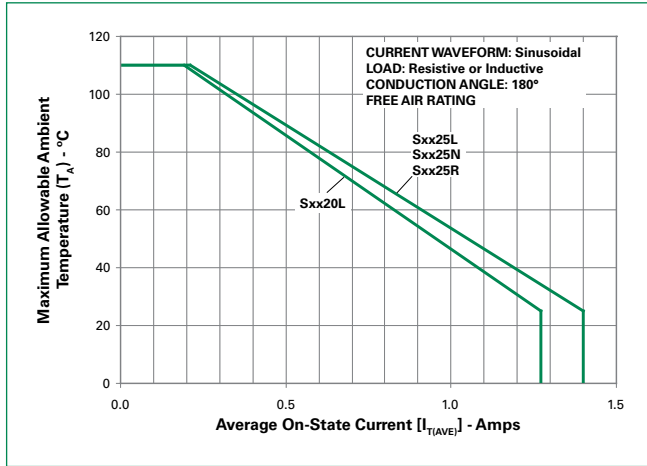
**Figure 7: Maximum Allowable Case Temperature vs. Average On-State Current**



**Figure 8: Maximum Allowable Ambient Temperature vs. RMS On-State Current**

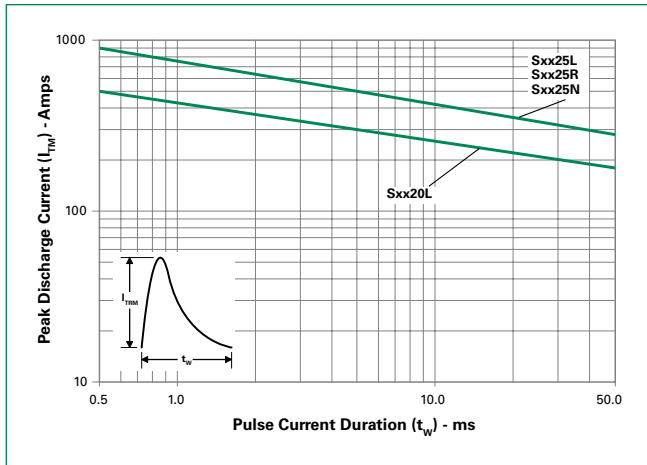


**Figure 9: Maximum Allowable Ambient Temperature vs. Average On-State Current**

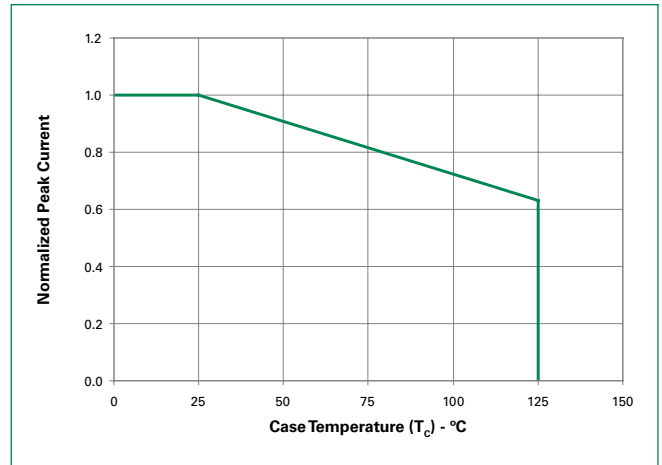


Note: xx = voltage

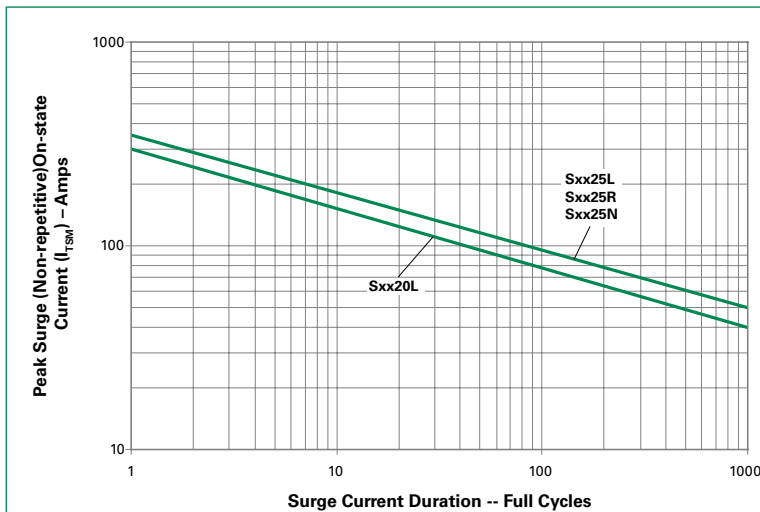
**Figure 10: Peak Capacitor Discharge Current**



**Figure 11: Peak Capacitor Discharge Current Derating**



**Figure 12: Surge Peak On-State Current vs. Number of Cycles**



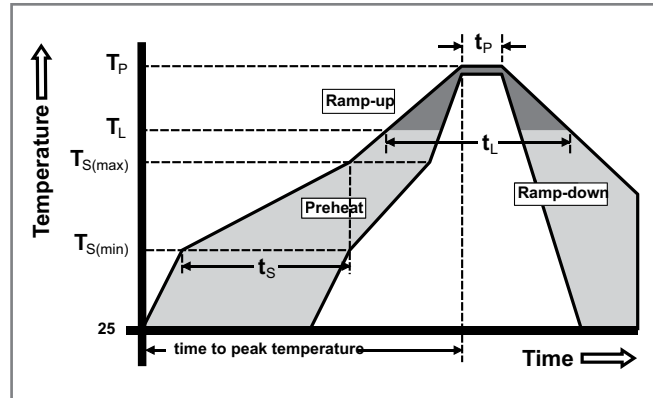
SUPPLY FREQUENCY: 60 Hz Sinusoidal  
LOAD: Resistive  
RMS On-State Current: [ $I_{T(RMS)}$ ]: Maximum Rated Value at Specified Case Temperature

Notes:

1. Gate control may be lost during and immediately following surge current interval.
2. Overload may not be repeated until junction temperature has returned to steady-state rated value.

### Soldering Parameters

Reflow Condition		Pb – Free assembly
Pre Heat	- Temperature Min ( $T_{s(min)}$ )	150°C
	- Temperature Max ( $T_{s(max)}$ )	200°C
	- Time (min to max) ( $t_s$ )	60 – 180 secs
Average ramp up rate (Liquidus Temp) ( $T_L$ ) to peak		5°C/second max
$T_{s(max)}$ to $T_L$ - Ramp-up Rate		5°C/second max
Reflow	- Temperature ( $T_L$ ) (Liquidus)	217°C
	- Temperature ( $t_l$ )	60 – 150 seconds
Peak Temperature ( $T_p$ )		260 <sup>+0/-5</sup> °C
Time within 5°C of actual peak Temperature ( $t_p$ )		20 – 40 seconds
Ramp-down Rate		5°C/second max
Time 25°C to peak Temperature ( $T_p$ )		8 minutes Max.
Do not exceed		280°C



### Physical Specifications

<b>Terminal Finish</b>	100% Matte Tin-plated
<b>Body Material</b>	UL recognized epoxy meeting flammability classification 94V-0
<b>Lead Material</b>	Copper Alloy

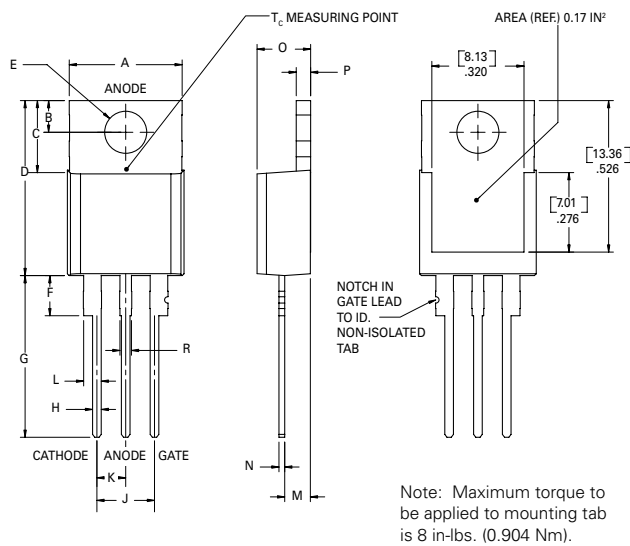
### Design Considerations

Careful selection of the correct device for the application's operating parameters and environment will go a long way toward extending the operating life of the Thyristor. Good design practice should limit the maximum continuous current through the main terminals to 75% of the device rating. Other ways to ensure long life for a power discrete semiconductor are proper heat sinking and selection of voltage ratings for worst case conditions. Overheating, overvoltage (including dv/dt), and surge currents are the main killers of semiconductors. Correct mounting, soldering, and forming of the leads also help protect against component damage.

### Environmental Specifications

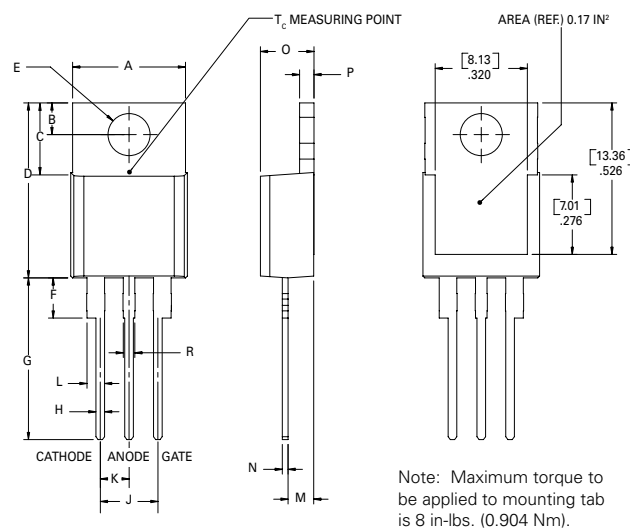
Test	Specifications and Conditions
<b>AC Blocking</b>	MIL-STD-750, M-1040, Cond A Applied Peak AC voltage @ 125°C for 1008 hours
<b>Temperature Cycling</b>	MIL-STD-750, M-1051, 100 cycles; -40°C to +150°C; 15-min dwell-time
<b>Temperature/Humidity</b>	EIA / JEDEC, JESD22-A101 1008 hours; 320V - DC: 85°C; 85% rel humidity
<b>High Temp Storage</b>	MIL-STD-750, M-1031, 1008 hours; 150°C
<b>Low-Temp Storage</b>	1008 hours; -40°C
<b>Thermal Shock</b>	MIL-STD-750, M-1056 10 cycles; 0°C to 100°C; 5-min dwelltime at each temperature; 10 sec (max) transfer time between temperature
<b>Autoclave</b>	EIA / JEDEC, JESD22-A102 168 hours (121°C at 2 ATMs) and 100% R/H
<b>Resistance to Solder Heat</b>	MIL-STD-750 Method 2031
<b>Solderability</b>	ANSI/J-STD-002, category 3, Test A
<b>Lead Bend</b>	MIL-STD-750, M-2036 Cond E

**Dimensions — TO-220AB (R-Package) — Non-Isolated Mounting Tab Common with Center Lead**



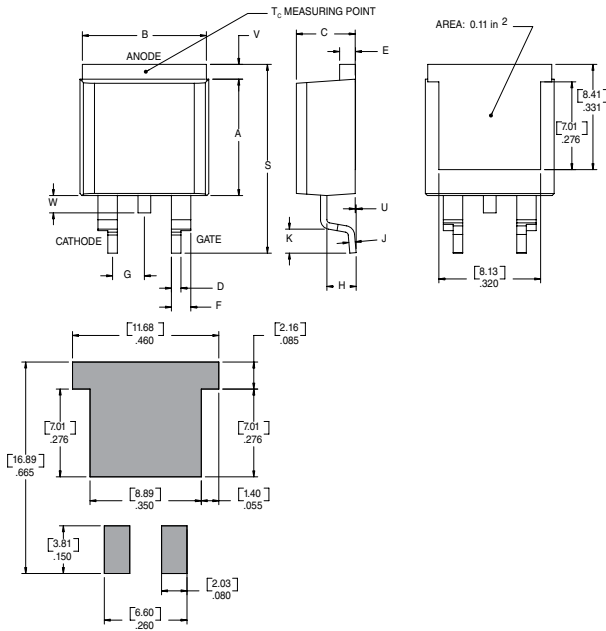
Dimension	Inches		Millimeters	
	Min	Max	Min	Max
A	0.380	0.420	9.65	10.67
B	0.105	0.115	2.67	2.92
C	0.230	0.250	5.84	6.35
D	0.590	0.620	14.99	15.75
E	0.142	0.147	3.61	3.73
F	0.110	0.130	2.79	3.30
G	0.540	0.575	13.72	14.61
H	0.025	0.035	0.64	0.89
J	0.195	0.205	4.95	5.21
K	0.095	0.105	2.41	2.67
L	0.060	0.075	1.52	1.91
M	0.085	0.095	2.16	2.41
N	0.018	0.024	0.46	0.61
O	0.178	0.188	4.52	4.78
P	0.045	0.060	1.14	1.52
R	0.038	0.048	0.97	1.22

**Dimensions — TO-220AB (L-Package) — Isolated Mounting Tab**



Dimension	Inches		Millimeters	
	Min	Max	Min	Max
A	0.380	0.420	9.65	10.67
B	0.105	0.115	2.67	2.92
C	0.230	0.250	5.84	6.35
D	0.590	0.620	14.99	15.75
E	0.142	0.147	3.61	3.73
F	0.110	0.130	2.79	3.30
G	0.540	0.575	13.72	14.61
H	0.025	0.035	0.64	0.89
J	0.195	0.205	4.95	5.21
K	0.095	0.105	2.41	2.67
L	0.060	0.075	1.52	1.91
M	0.085	0.095	2.16	2.41
N	0.018	0.024	0.46	0.61
O	0.178	0.188	4.52	4.78
P	0.045	0.060	1.14	1.52
R	0.038	0.048	0.97	1.22

**Dimensions –TO- 263AB (N-package) – D<sup>2</sup>-Pak Surface Mount**



Dimension	Inches		Millimeters	
	Min	Max	Min	Max
A	0.360	0.370	9.14	9.40
B	0.380	0.420	9.65	10.67
C	0.178	0.188	4.52	4.78
D	0.025	0.035	0.64	0.89
E	0.045	0.060	1.14	1.52
F	0.060	0.075	1.52	1.91
G	0.095	0.105	2.41	2.67
H	0.092	0.102	2.34	2.59
J	0.018	0.024	0.46	0.61
K	0.090	0.110	2.29	2.79
S	0.590	0.625	14.99	15.88
V	0.035	0.045	0.89	1.14
U	0.002	0.010	0.05	0.25
W	0.040	0.070	1.016	1.78

**Product Selector**

Part Number	Voltage				Gate Sensitivity	Type	Package
	400V	600V	800V	1000V			
Sxx20L	X	X	X	X	30mA	Standard SCR	TO-220L
Sxx25L	X	X	X	X	35mA	Standard SCR	TO-220L
Sxx25R	X	X	X	X	35mA	Standard SCR	TO-220R
Sxx25N	X	X	X	X	35mA	Standard SCR	TO-263

Note: xx = Voltage

**Packing Options**

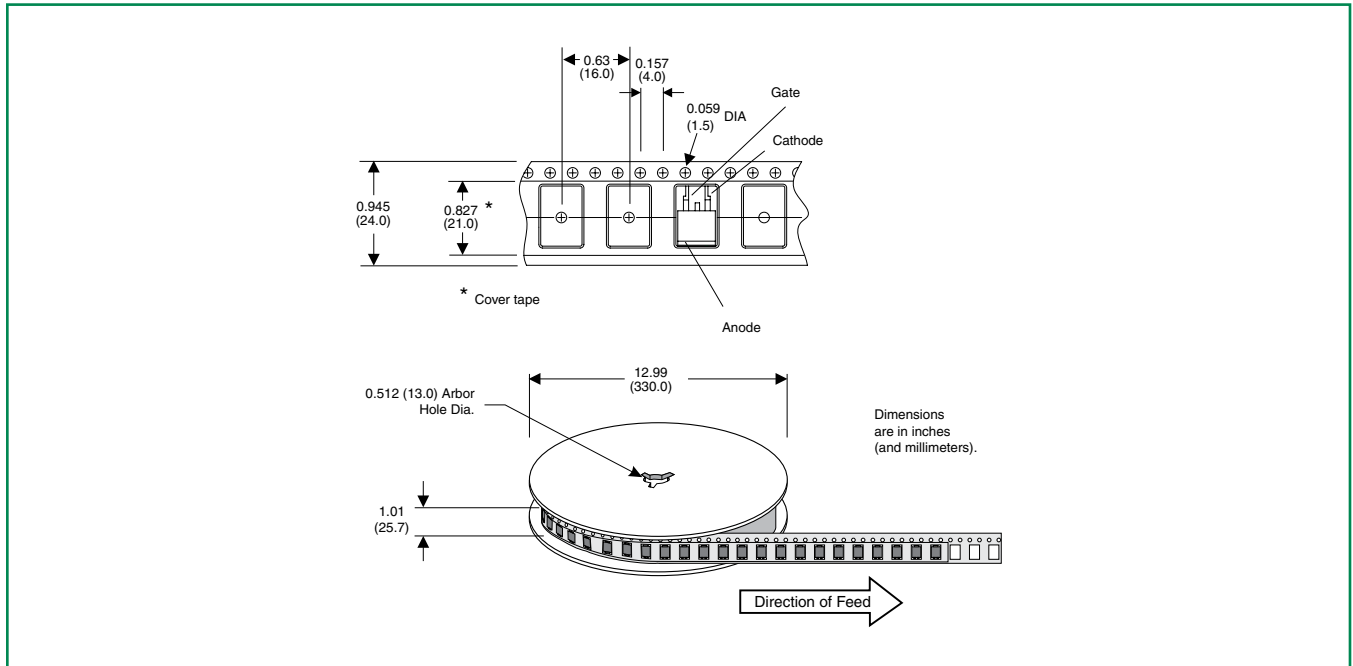
Part Number	Marking	Weight	Packing Mode	Base Quantity
Sxx20L	Sxx20L	2.2g	Bulk	500
Sxx20LTP	Sxx20L	2.2g	Tube	500 (50 per tube)
Sxx25L	Sxx25L	2.2g	Bulk	500
Sxx25LTP	Sxx25L	2.2g	Tube	500 (50 per tube)
Sxx25R	Sxx25R	2.2g	Bulk	500
Sxx25RTP	Sxx25R	2.2g	Tube	500 (50 per tube)
Sxx25NTP	Sxx25N	1.6g	Tube	500 (50 per tube)
Sxx25NRP	Sxx25N	1.6g	Embossed Carrier	500

Note: xx = Voltage

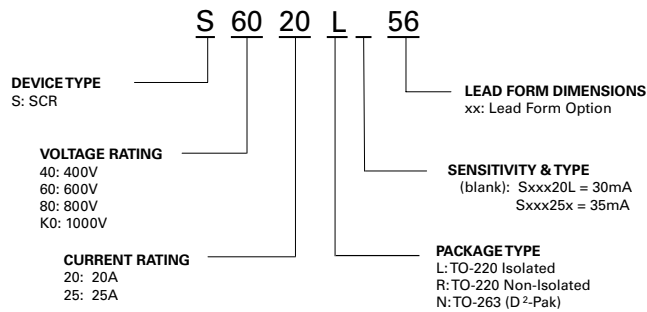


**TO-263 Embossed Carrier Reel Pack (RP) Specifications**

Meets all EIA-481-2 Standards

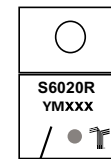


**Part Numbering System**



**Part Marking System**

TO-220 AB - (L and R Package)  
TO-263 AB - (N Package)



Date Code Marking  
Y: Year Code  
M: Month Code  
XXX: Lot Trace Code

Компания «Life Electronics» занимается поставками электронных компонентов импортного и отечественного производства от производителей и со складов крупных дистрибьюторов Европы, Америки и Азии.

С конца 2013 года компания активно расширяет линейку поставок компонентов по направлению коаксиальный кабель, кварцевые генераторы и конденсаторы (керамические, пленочные, электролитические), за счёт заключения дистрибьюторских договоров

Мы предлагаем:

- Конкурентоспособные цены и скидки постоянным клиентам.
- Специальные условия для постоянных клиентов.
- Подбор аналогов.
- Поставку компонентов в любых объемах, удовлетворяющих вашим потребностям.
- Приемлемые сроки поставки, возможна ускоренная поставка.
- Доставку товара в любую точку России и стран СНГ.
- Комплексную поставку.
- Работу по проектам и поставку образцов.
- Формирование склада под заказчика.
- Сертификаты соответствия на поставляемую продукцию (по желанию клиента).
- Тестирование поставляемой продукции.
- Поставку компонентов, требующих военную и космическую приемку.
- Входной контроль качества.
- Наличие сертификата ISO.

В составе нашей компании организован Конструкторский отдел, призванный помогать разработчикам, и инженерам.

Конструкторский отдел помогает осуществить:

- Регистрацию проекта у производителя компонентов.
- Техническую поддержку проекта.
- Защиту от снятия компонента с производства.
- Оценку стоимости проекта по компонентам.
- Изготовление тестовой платы монтаж и пусконаладочные работы.



Тел: +7 (812) 336 43 04 (многоканальный)  
Email: [org@lifeelectronics.ru](mailto:org@lifeelectronics.ru)