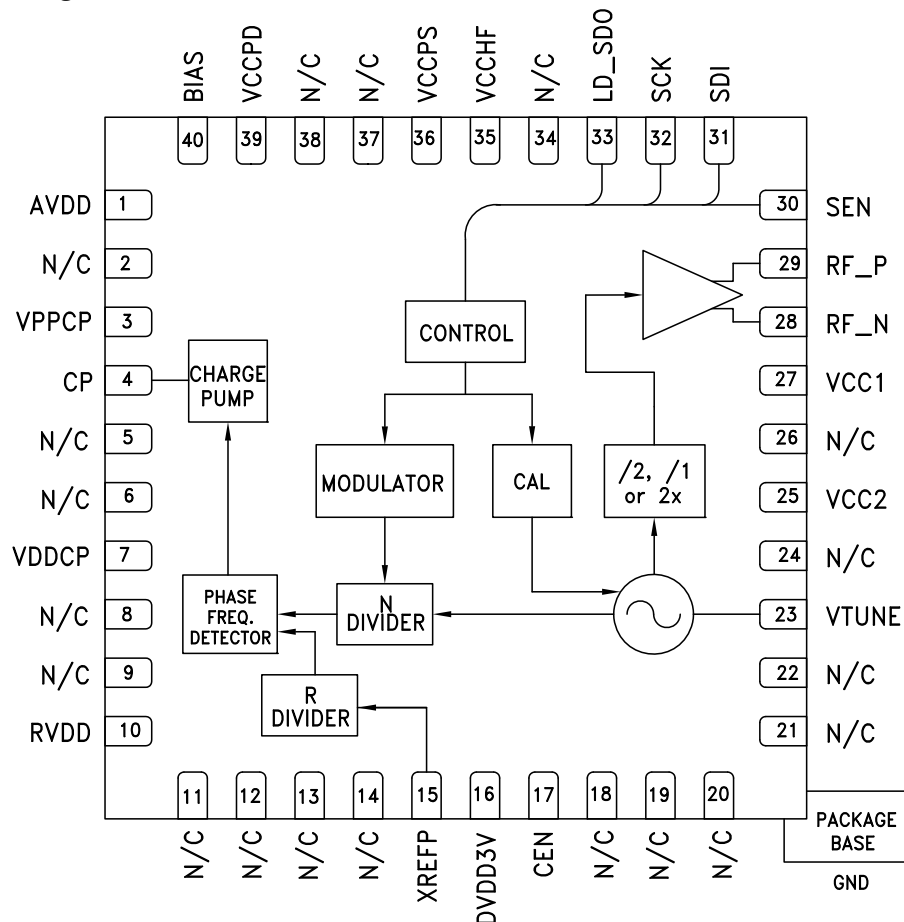

**FRACTIONAL-N PLL WITH INTEGRATED VCO**  
**795 - 945, 1590 - 1890, 3180 - 3780 MHz****Features**

- Tri-band RF Bandwidth: 795 - 945, 1590 - 1890, 3180 - 3780 MHz
- Ultra Low Phase Noise -111 dBc/Hz in Band Typ.
- Figure of Merit (FOM) -227 dBc/Hz
- < 180 fs RMS Jitter
- 24-bit Step Size, Resolution 3 Hz typ
- Exact Frequency Mode
- Built-in Digital Self Test
- 40 Lead 6x6 mm SMT Package: 36 mm<sup>2</sup>

**Typical Applications**

- Cellular/4G Infrastructure
- Repeater and Femtocells
- Communications Test Equipment
- CATV Equipment
- Phased Array Applications
- DDS Replacement
- Very High Data Rate Radios

**Functional Diagram**



## FRACTIONAL-N PLL WITH INTEGRATED VCO 795 - 945, 1590 - 1890, 3180 - 3780 MHz

### General Description

The HMC838LP6CE is a fully functional Fractional-N Phase-Locked-Loop (PLL) with an Integrated Voltage Controlled Oscillator (VCO). The PLL consists of an integrated low noise VCO with a tri-band output, an autocalibration subsystem for low voltage VCO tuning, a very low noise digital Phase Detector (PD), a precision controlled charge pump, a low noise reference path divider and a fractional divider.

The fractional PLL features an advanced delta-sigma modulator design that allows both ultra-fine step sizes and low spurious products. The phase detector (PD) features cycle slip prevention (CSP) technology to allow faster frequency hopping times. Ultra low in-close phase noise and low spurious also allows wider loop bandwidths for faster frequency hopping and low micro-phonics.

For theory of operation and register map refer to the [“PLLs with Integrated VCOs - RF VCOs Operating Guide”](#). To view the Operating Guide, please visit [www.hittite.com](http://www.hittite.com) and choose HMC838LP6CE from the “Search by Part Number” pull down menu.

**Electrical Specifications,  $T_A = +25^\circ\text{C}$ , VPPCP, VDDCP, VCC1, VCC2 = 5V  $\pm$ 4%;  
RVDD, AVDD, DVDD3V, VCCPD, VCCHF, VCCPS = 3.3V  $\pm$ 6% GNDCP = GNDLS = Ground  
Paddle = 0V, 50 MHz Reference Unless Otherwise Noted**

| Parameter                           | Condition  | Min. | Typ.            | Max.    | Units |
|-------------------------------------|--|------|-----------------|---------|-------|
| <b>RF Output Characteristics</b>    |  |      |                 |         |       |
| VCO Frequency at PLL Input          |  | 1590 | 1710            | 1890    | MHz   |
| RF Output Frequency at $f_{VCO}/2$  |  | 795  | 855             | 945     | MHz   |
| RF Output Frequency at $f_{VCO}$    |  | 1590 | 1710            | 1890    | MHz   |
| RF Output Frequency at $2f_{VCO}$   |  | 3180 | 3420            | 3780    | MHz   |
| RF Output Power at $f_{VCO}/2$      |  | 7.5  | 10              | 12.5    | dBm   |
| RF Output Power at $f_{VCO}$        |  | 4.5  | 7.5             | 11      | dBm   |
| RF Output Power at $2f_{VCO}$       |  | -9   | -4              | 1       | dBm   |
| VCO Tuning Sensitivity              | Measured at $f_o$ , 2V (N= 0/15/31)  | 8    | 11              | 16      | MHz/V |
| VCO Supply Pushing                  | Measured at $f_o$ , 2V   |      | 1.3             |         | MHz/V |
| RF Output $f_o/2$ Harmonic          | Doubler Mode   |      | -24             |         | dBc   |
| RF Output $3f_o/2$ Harmonic         | Doubler Mode   |      | -38             |         | dBc   |
| RF Output 2nd Harmonic              | $f_o/2/f_o/2f_o$   |      | -25 / -22 / -28 |         | dBc   |
| RF Output $5f_o/2$ Harmonic         | Doubler Mode   |      | -50             |         | dBc   |
| RF Output 3rd Harmonic              | $f_o/2/f_o/2f_o$   |      | -29 / -32 / -50 |         | dBc   |
| RF Output $7f_o/2$ Harmonic         | Doubler Mode   |      | -57             |         | dBc   |
| RF Output 4th Harmonic              | $f_o/2/f_o/2f_o$   |      | -30 / -42 / -57 |         | dBc   |
| <b>RF Divider Characteristics</b>   |  |      |                 |         |       |
| 19-Bit N-Divider Range (Integer)    | Max = $2^{19} - 1$   | 16   |                 | 524,287 |       |
| 19-Bit N-Divider Range (Fractional) | Fractional nominal divide ratio varies (-3 / +3) dynamically max   | 20   |                 | 524,283 |       |
| <b>REF Input Characteristics</b>    |  |      |                 |         |       |
| Ref Input Frequency                 | Synthesizer phase noise can degrade by about 5dB when operating with a reference frequency near the low end of this range. | 10   | 50              | 200     | MHz   |
| Ref Input Range                     | AC Coupled   | 1    | 2               | 3.3     | Vpp   |
| Ref Input Capacitance               |  |      |                 | 5       | pF    |
| 14-Bit R-Divider Range              |  | 1    |                 | 16,383  |       |

**FRACTIONAL-N PLL WITH INTEGRATED VCO  
795 - 945, 1590 - 1890, 3180 - 3780 MHz**
**Electrical Specifications (Continued)**

| Parameter  | Condition                          | Min.       | Typ.         | Max.   | Units  |
|--|------------------------------------|------------|--------------|--------|--------|
| <b>Phase Detector (PD)</b>   |                                    |            |              |        |        |
| PD Frequency Fractional Feedback Mode                                  | [1]                                | 0.1        |              | 100    | MHz    |
| PD Frequency Fractional Feedforward Mode (and Register 6 [17:16] = 10) |                                    | 0.1        |              | 80     | MHz    |
| PD Frequency Integer Mode  | [1]                                | 0.1        |              | 125    | MHz    |
| <b>Charge Pump</b>   |                                    |            |              |        |        |
| Output Current   |                                    | 0.02       |              | 2.54   | mA     |
| Charge Pump Gain Step Size   |                                    |            | 20           |        | μA     |
| PD/Charge Pump SSB Phase Noise   | Input Referred, Maximum CP Current |            |              |        |        |
| 100 Hz   |                                    |            | -132         |        | dBc/Hz |
| 1 kHz  |                                    |            | -142         |        | dBc/Hz |
| 10 kHz   | Add 1 dB for Fractional            | -151       | -149         | -147   | dBc/Hz |
| 100 kHz  | Add 3 dB for Fractional            | -155       | -153         | -151   | dBc/Hz |
| <b>Logic Inputs</b>  |                                    |            |              |        |        |
| VIH Output High Voltage  |                                    | DVDD3V-0.4 |              | DVDD3V | V      |
| VIL Output Low Voltage   |                                    | 0          |              | 0.4    | V      |
| <b>Logic Outputs</b>   |                                    |            |              |        |        |
| VOH Output High Voltage  |                                    | DVDD3V-0.4 |              | DVDD3V | V      |
| VOL Output Low Voltage   |                                    | 0          |              | 0.4    | V      |
| <b>Power Supply Voltages</b>   |                                    |            |              |        |        |
| Analog 3.3V Supplies   | AVDD, VCCHF, VCCPS, VCCPD, RVDD    | 3.0        | 3.3          | 3.5    | V      |
| Digital Supply   | DVDD3V                             | 3.0        | 3.3          | 3.5    | V      |
| Analog 5V Supplies   | VPPCP, VDDCP, VCC1, VCC2           | 4.8        | 5            | 5.2    | V      |
| <b>Power Supply Currents</b>   |                                    |            |              |        |        |
| +5V Analog Charge Pump   | VPPCP, VDDCP                       |            | 5.3          |        | mA     |
| +5V VCO, PLL Buffer and RF Buffer                                      | VCC1 + VCC2 (fo / 2 / fo / 2fo)    |            | 88 / 72 / 71 |        | mA     |
| +3.3V Analog   | AVDD, VCCHF, VCCPS, VCCPD, RVDD    |            | 45           |        | mA     |
| +3.3V Digital  | DVDD3V                             |            | 6.5          |        | mA     |
| Power Down - Crystal Off   | Reg 01h=0, Crystal Not Clocked     |            | 10           |        | μA     |
| Power Down - Crystal On, 100 MHz                                       | Reg 01h=0, Crystal Clocked 100 MHz |            | 10           | 200    | μA     |
| <b>Power on Reset</b>  |                                    |            |              |        |        |
| Typical Reset Voltage on DVDD  |                                    |            | 700          |        | mV     |
| Min DVDD Voltage for No Reset  |                                    | 1.5        |              |        | V      |
| Power on Reset Delay   |                                    |            | 250          |        | μs     |
| <b>VCO Open Loop Phase Noise at fo/2</b>                               |                                    |            |              |        |        |
| 10 kHz Offset  |                                    |            | -93          |        | dBc/Hz |
| 100 kHz Offset   |                                    |            | -123         |        | dBc/Hz |
| 1 MHz Offset   |                                    |            | -148         |        | dBc/Hz |
| 10 MHz Offset  |                                    |            | -163         |        | dBc/Hz |
| 100 MHz Offset   |                                    |            | -166         |        | dBc/Hz |

Note 1: This maximum phase detector frequency can only be achieved if the minimum N value is respected. eg. In the case of fractional feedback mode, the maximum PFD rate = fvc0/20 or 100 MHz, whichever is less.



## FRACTIONAL-N PLL WITH INTEGRATED VCO 795 - 945, 1590 - 1890, 3180 - 3780 MHz

### Electrical Specifications (Continued)

| Parameter  | Condition                              | Min. | Typ. | Max. | Units  |
|--|--|------|------|------|--------|
| <b>VCO Open Loop Phase Noise at <math>f_o</math></b>               |  |      |      |      |        |
| 10 kHz Offset  |  |      | -88  |      | dBc/Hz |
| 100 kHz Offset   |  |      | -118 |      | dBc/Hz |
| 1 MHz Offset   |  |      | -143 |      | dBc/Hz |
| 10 MHz Offset  |  |      | -162 |      | dBc/Hz |
| 100 MHz Offset   |  |      | -168 |      | dBc/Hz |
| <b>VCO Open Loop Phase Noise at <math>2f_o</math></b>              |  |      |      |      |        |
| 10 kHz Offset  |  |      | -81  |      | dBc/Hz |
| 100 kHz Offset   |  |      | -112 |      | dBc/Hz |
| 1 MHz Offset   |  |      | -135 |      | dBc/Hz |
| 10 MHz Offset  |  |      | -157 |      | dBc/Hz |
| 100 MHz Offset   |  |      | -160 |      | dBc/Hz |
| <b>Closed Loop Phase Noise PLL + VCO at <math>f_{vco}/2</math></b> |  |      |      |      |        |
| Integer, 50 MHz PD   | 1 kHz Offset                           |      | -119 |      | dBc/Hz |
| Integer, 50 MHz PD   | 10 kHz Offset                          |      | -123 |      | dBc/Hz |
| Integer, 50 MHz PD   | 100 kHz Offset                         |      | -119 |      | dBc/Hz |
| Fractional, 50 MHz PD  | 1 kHz Offset                           |      | -113 |      | dBc/Hz |
| Fractional, 50 MHz PD  | 10 kHz Offset                          |      | -115 |      | dBc/Hz |
| Fractional, 50 MHz PD  | 100 kHz Offset                         |      | -121 |      | dBc/Hz |
| <b>Closed Loop Phase Noise PLL + VCO at <math>f_{vco}</math></b>   |  |      |      |      |        |
| Integer, 50 MHz PD   | 1 kHz Offset                           |      | -114 |      | dBc/Hz |
| Integer, 50 MHz PD   | 10 kHz Offset                          |      | -118 |      | dBc/Hz |
| Integer, 50 MHz PD   | 100 kHz Offset                         |      | -113 |      | dBc/Hz |
| Fractional, 50 MHz PD  | 1 kHz Offset                           |      | -107 |      | dBc/Hz |
| Fractional, 50 MHz PD  | 10 kHz Offset                          |      | -108 |      | dBc/Hz |
| Fractional, 50 MHz PD  | 100 kHz Offset                         |      | -115 |      | dBc/Hz |
| <b>Closed Loop Phase Noise PLL + VCO at <math>2f_o</math></b>      |  |      |      |      |        |
| Integer, 50 MHz PD   | 1 kHz Offset                           |      | -108 |      | dBc/Hz |
| Integer, 50 MHz PD   | 10 kHz Offset                          |      | -112 |      | dBc/Hz |
| Integer, 50 MHz PD   | 100 kHz Offset                         |      | -107 |      | dBc/Hz |
| Fractional, 50 MHz PD  | 1 kHz Offset                           |      | -100 |      | dBc/Hz |
| Fractional, 50 MHz PD  | 10 kHz Offset                          |      | -102 |      | dBc/Hz |
| Fractional, 50 MHz PD  | 100 kHz Offset                         |      | -109 |      | dBc/Hz |
| <b>Synthesizer Figure of Merit</b>                                 |  |      |      |      |        |
|  | Normalized 1 Hz                        |      |      |      |        |
| Integer Mode   | Measured w/ 50 MHz PD at 30 kHz Offset |      | -229 |      | dBc/Hz |
| Fractional Mode  | Measured w/ 50 MHz PD at 30 kHz Offset |      | -227 |      | dBc/Hz |



**FRACTIONAL-N PLL WITH INTEGRATED VCO  
795 - 945, 1590 - 1890, 3180 - 3780 MHz**

PLLS W/ INTEGRATED VCO - SMT

**Closed Loop Integer Phase Noise**

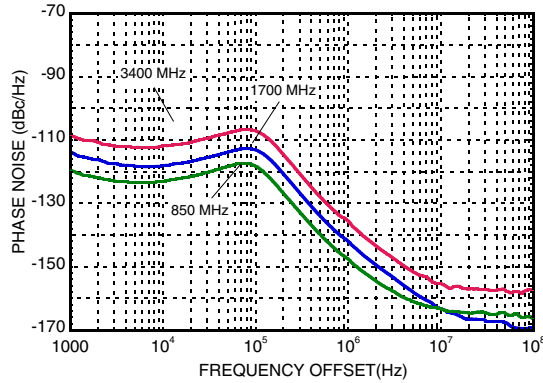

**Typical Closed Loop Fractional Phase Noise [1]**

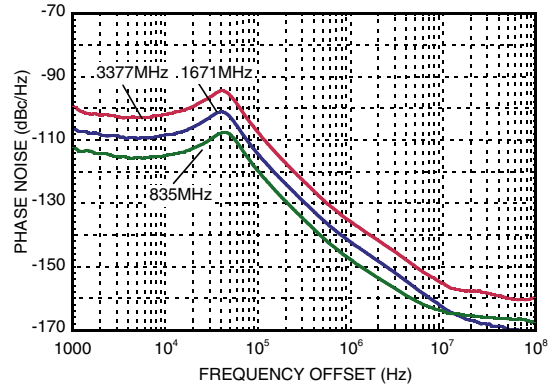

**Free Running Phase Noise**

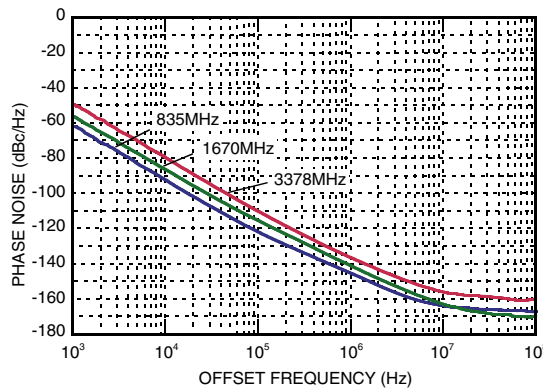

**Typical Tuning Curves vs. Switch Position**

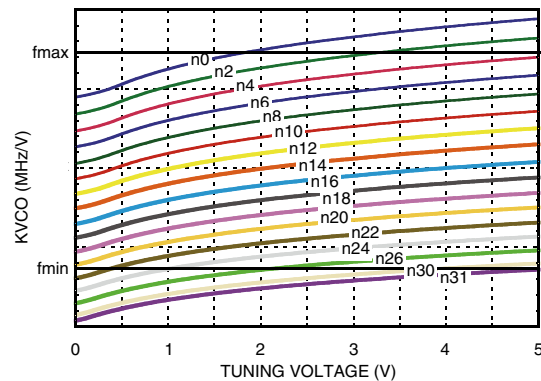

**Free Running VCO Phase Noise Over Temperature**

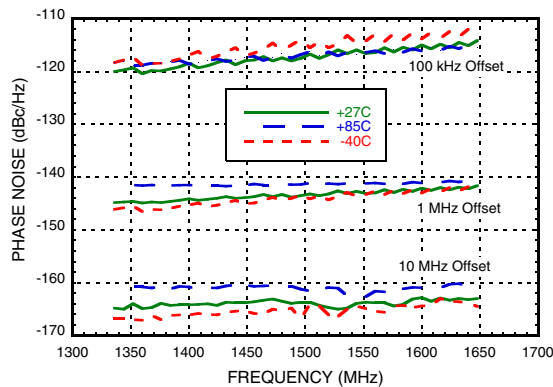

**Typical VCO Tuning Voltage After Calibration**

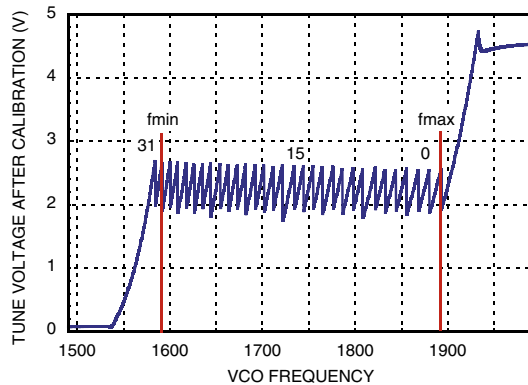

[1] Fractional Mode, 50 MHz Crystal, R=1

**FRACTIONAL-N PLL WITH INTEGRATED VCO**  
**795 - 945, 1590 - 1890, 3180 - 3780 MHz**



**Typical VCO Sensitivity vs. Cap @ Fo Voltage**

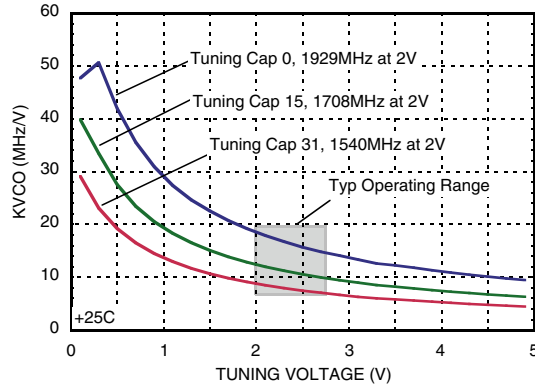

**Typical Spurious @ 200 kHz from Integer Boundary**

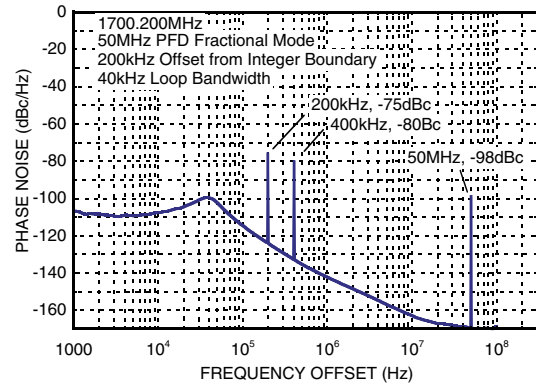

**Typical Output Power - Narrow Band Match**

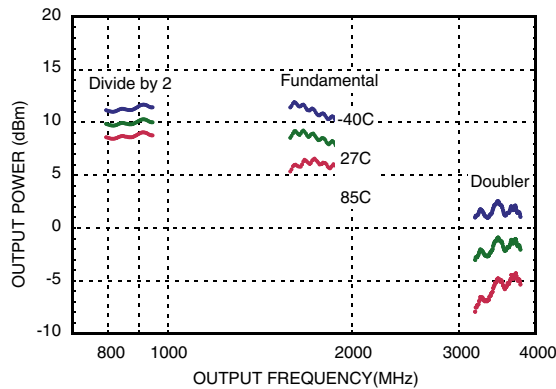

**Figure of Merit**

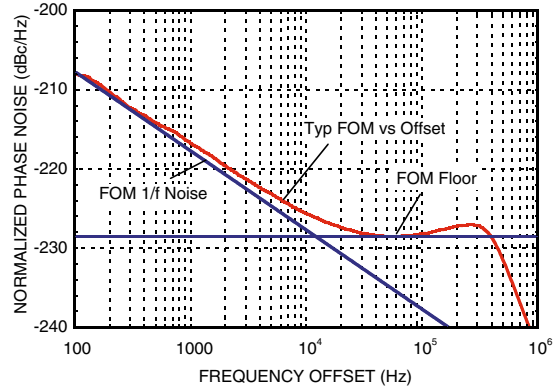

Information furnished by Analog Devices is believed to be accurate and reliable. However, no responsibility is assumed by Analog Devices for its use, nor for any infringements of patents or other rights of third parties that may result from its use. Specifications subject to change without notice. No license is granted by implication or otherwise under any patent or patent rights of Analog Devices. Trademarks and registered trademarks are the property of their respective owners.

For price, delivery, and to place orders: Analog Devices, Inc., One Technology Way, P.O. Box 9106, Norwood, MA 02062-9106 Phone: 781-329-4700 • Order online at [www.analog.com](http://www.analog.com) Application Support: Phone: 1-800-ANALOG-D



## FRACTIONAL-N PLL WITH INTEGRATED VCO 795 - 945, 1590 - 1890, 3180 - 3780 MHz

### Pin Descriptions

| Pin Number  | Function            | Description   |
|---|---------------------|---|
| 1   | AVDD                | DC Power Supply for analog circuitry.   |
| 2, 5, 6, 8, 9,<br>11 - 14, 18 - 22, 24,<br>26, 34, 37, 38 | N/C                 | The pins are not connected internally; however, all data shown herein was measured with these pins connected to RF/DC ground externally.  |
| 3   | VPPCP               | Power Supply for charge pump analog section   |
| 4   | CP                  | Charge Pump Output  |
| 7   | VDDCP               | Power Supply for the charge pump digital section  |
| 10  | RVDD                | Reference Supply  |
| 15  | XREFP               | Reference Oscillator Input  |
| 16  | DVDD3V              | DC Power Supply for Digital (CMOS) Circuitry  |
| 17  | CEN                 | Chip Enable. Connect to logic high for normal operation.  |
| 23  | VTUNE               | VCO Varactor. Tuning Port Input.  |
| 25  | VCC2                | VCO Analog Supply 2   |
| 27  | VCC1                | VCO Analog Supply 1   |
| 28  | RF_N <sup>[1]</sup> | RF Positive Output  |
| 29  | RF_P <sup>[1]</sup> | RF Negative Output  |
| 30  | SEN                 | PLL Serial Port Enable (CMOS) Logic Input   |
| 31  | SDI                 | PLL Serial Port Data (CMOS) Logic Input   |
| 32  | SCK                 | PLL Serial Port Clock (CMOS) Logic Input  |
| 33  | LD_SDO              | Lock Detect, or Serial Data, or General Purpose (CMOS) Logic Output (GPO)   |
| 35  | VCCHF               | DC Power Supply for Analog Circuitry  |
| 36  | VCCPS               | DC Power Supply for Analog Prescaler  |
| 39  | VCCPD               | DC Power Supply for Phase Detector  |
| 40  | BIAS                | External bypass decoupling for precision bias circuits.<br>Note: 1.920V ±20mV reference voltage (BIAS) is generated internally and cannot drive an external load. Must be measured with 10GΩ meter such as Agilent 34410A, normal 10MΩ DVM will read erroneously. |

[1] For doubler mode of operation, pin 28 (RF\_N) and pin 29 (RF\_P) outputs must be shorted together.

**FRACTIONAL-N PLL WITH INTEGRATED VCO**  
**795 - 945, 1590 - 1890, 3180 - 3780 MHz**
**Absolute Maximum Ratings**

|  |                |
|--|----------------|
| AVDD, RVDD, DVDD3V, VCCPD, VCCHF, VCCPS                                    | -0.3V to +3.6V |
| VPPCP, VDDCP, VCC1   | -0.3V to +5.5V |
| VCC2   | -0.3V to +5.5V |
| Operating Temperature  | -40°C to +85°C |
| Storage Temperature  | -65°C to 125°C |
| Maximum Junction Temperature   | 150 °C         |
| Thermal Resistance ( $\Theta_{JC}$ )<br>[junction to case (ground paddle)] | 9 °C/W         |
| Reflow Soldering   |                |
| Peak Temperature   | 260°C          |
| Time at Peak Temperature   | 40 sec         |
| ESD Sensitivity (HBM)  | Class 1B       |

Stresses above those listed under Absolute Maximum Ratings may cause permanent damage to the device. This is a stress rating only; functional operation of the device at these or any other conditions above those indicated in the operational section of this specification is not implied. Exposure to absolute maximum rating conditions for extended periods may affect device reliability.

**Recommended Operating Conditions**

| Parameter                               | Condition | Min. | Typ. | Max. | Units |
|---|-----------|------|------|------|-------|
| <b>Temperature</b>                      |           |      |      |      |       |
| Junction Temperature                    |           | -    | -    | 125  | °C    |
| Ambient Temperature                     |           | -40  | -    | 85   | °C    |
| <b>Supply Voltage</b>                   |           |      |      |      |       |
| AVDD, RVDD, DVDD3V, VCCPD, VCCHF, VCCPS |           | 3.0  | 3.3  | 3.5  | V     |
| VPPCP, VDDCP, VCC1, VCC2                |           | 4.8  | 5    | 5.2  | V     |

[1] Layout design guidelines set out in [Qualification Test Report](#) are strongly recommended.



## FRACTIONAL-N PLL WITH INTEGRATED VCO 795 - 945, 1590 - 1890, 3180 - 3780 MHz



### Outline Drawing

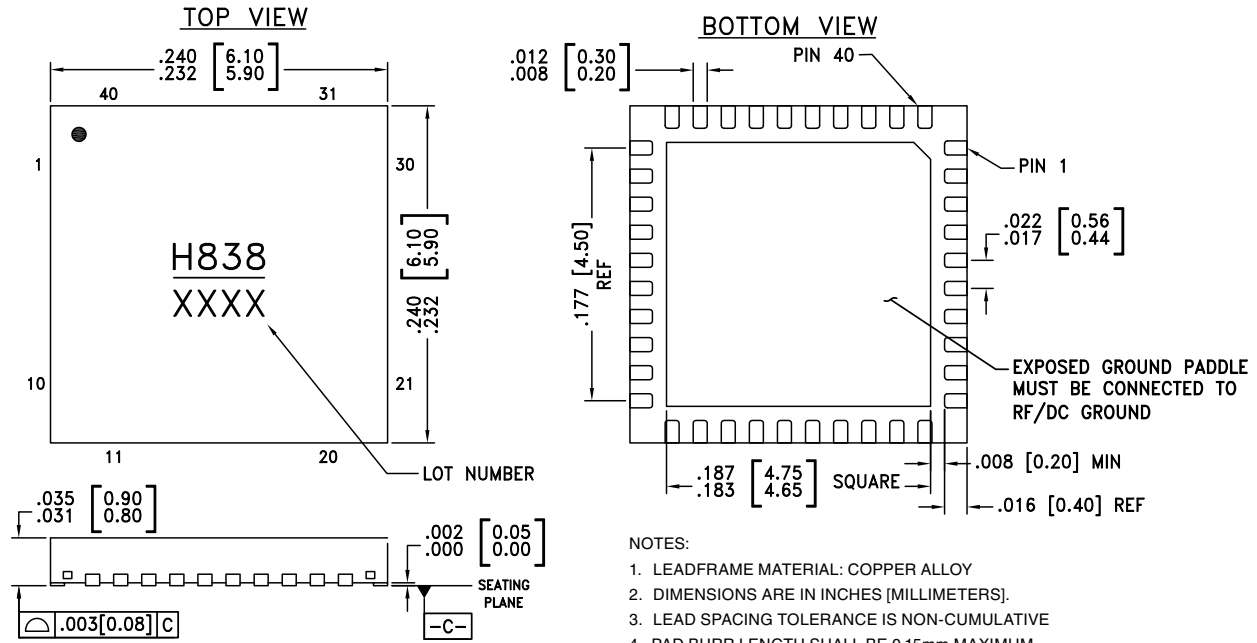

NOTES:

1. LEADFRAME MATERIAL: COPPER ALLOY
2. DIMENSIONS ARE IN INCHES [MILLIMETERS].
3. LEAD SPACING TOLERANCE IS NON-CUMULATIVE
4. PAD BURR LENGTH SHALL BE 0.15mm MAXIMUM.  
PAD BURR HEIGHT SHALL BE 0.05mm MAXIMUM.
5. PACKAGE WARP SHALL NOT EXCEED 0.05mm.
6. ALL GROUND LEADS AND GROUND PADDLE MUST BE SOLDERED TO PCB RF GROUND.
7. REFER TO HITTITE APPLICATION NOTE FOR SUGGESTED PCB LAND PATTERN.

### Package Information

| Part Number | Package Body Material                              | Lead Finish   | MSL Rating | Package Marking <sup>[1]</sup> |
|-------------|--|---------------|------------|--------------------------------|
| HMC838LP6CE | RoHS-compliant Low Stress Injection Molded Plastic | 100% matte Sn | MSL1       | H838<br>XXXX                   |

[1] 4-Digit lot number XXXX



**FRACTIONAL-N PLL WITH INTEGRATED VCO**  
**795 - 945, 1590 - 1890, 3180 - 3780 MHz**

**Evaluation PCB, fo & fo/2 Modes**

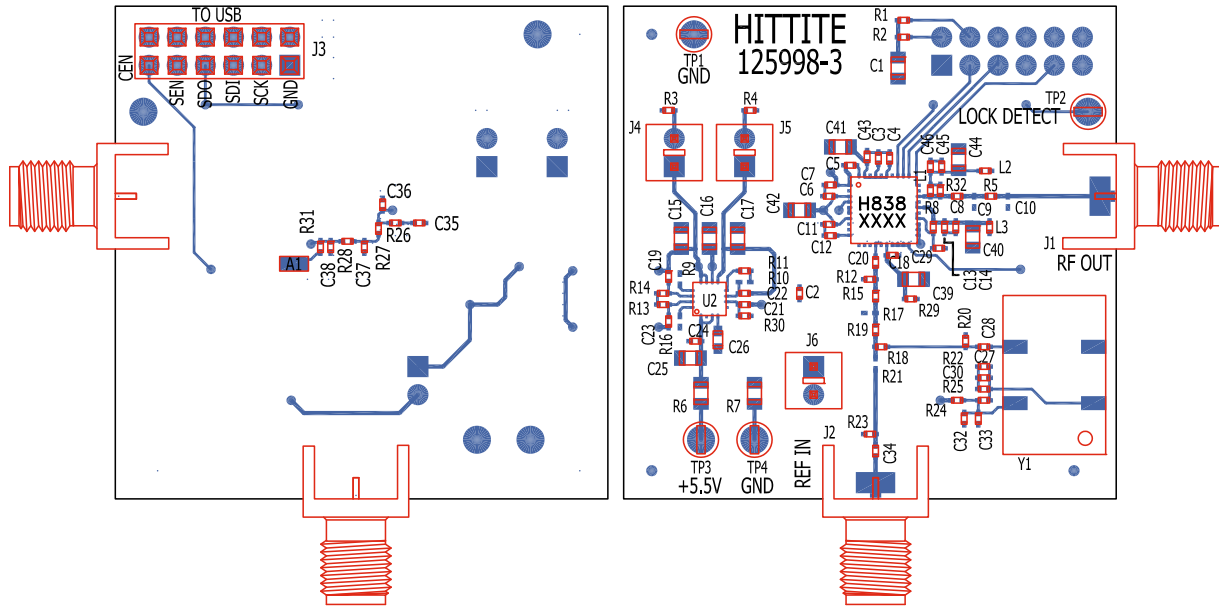

The circuit board used in the application should use RF circuit design techniques. Signal lines should have 50 Ohm impedance while the package ground leads and exposed paddle should be connected directly to the ground plane similar to that shown. A sufficient number of via holes should be used to connect the top and bottom ground planes. The evaluation circuit board shown is available from Hittite upon request.

**Evaluation PCB Schematic**

To view this [Evaluation PCB Schematic](http://www.hittite.com) please visit [www.hittite.com](http://www.hittite.com) and choose HMC838LP6CE from the "Search by Part Number" pull down menu to view the product splash page.

**FRACTIONAL-N PLL WITH INTEGRATED VCO  
795 - 945, 1590 - 1890, 3180 - 3780 MHz**
**List of Materials for  
Evaluation PCB 129511, fo & fo/2 Mode [1]**

| Item  | Description                                   |
|---|---|
| J1, J2  | PCB Mount SMA RF Connector                    |
| J3  | Dual Row Terminal Strip                       |
| J4 - J6   | Connector Header                              |
| C1, C15 - C17, C25                                | 10 $\mu$ F Capacitor, 0805 Pkg.               |
| C2, C3, C6, C7, C11, C12, C14, C18, C27, C43, C45 | 0.47 $\mu$ F Capacitor, 0402 Pkg.             |
| C4, C13   | 22 pF Capacitor, 0402 Pkg.                    |
| C5, C33   | 1000 pF Capacitor, 0402 Pkg.                  |
| C8  | 1.8 pF Capacitor, 0402 Pkg.                   |
| C19 - C24, C28, C30, C32, C34                     | 0.1 $\mu$ F Capacitor, 0402 Pkg.              |
| C26   | 1 $\mu$ F Capacitor, 0603 Pkg.                |
| C29   | 47 pF Capacitor, 0402 Pkg.                    |
| C35   | 3300 pF Capacitor, 0402 Pkg.                  |
| C36   | 270 pF Capacitor, 0402 Pkg.                   |
| C37, C38  | 68 pF Capacitor, 0402 Pkg.                    |
| C39 - C42, C44                                    | 4.7 $\mu$ F Tantalum Capacitor, 0805 Pkg      |
| R1, R2, R5, R8, R11, R15, R18, R19, R21, R24      | 0 Ohm Resistor, 0402 Pkg.                     |
| R3, R4  | 1 Ohm Resistor, 0402 Pkg.                     |
| R6, R7  | 0 Ohm Resistor, 0805 Pkg.                     |
| R12, R20, R29                                     | 51 Ohm Resistor, 0402 Pkg.                    |
| R22, R25  | 20 kOhm Resistor, 0402 Pkg.                   |
| R26 - R28   | 1k Ohm Resistor, 0402 Pkg.                    |
| L1  | 6.8 nH Inductor, 0402 Pkg.                    |
| TP3, TP4  | Test Point PC Compact SMT                     |
| U1  | HMC838LP6CE PLL with Integrated VCO           |
| U2  | HMC860LP3E<br>Low Noise Quad Linear Regulator |
| Y1  | 3.3V, 50 MHz VCXO Crystal Oscillator          |
| PCB [2]   | 125998 Evaluation Board                       |

[1] Reference this number when ordering complete evaluation PCB

[2] Circuit Board Material: Rogers 4350 or Arlon 25FR and FR4

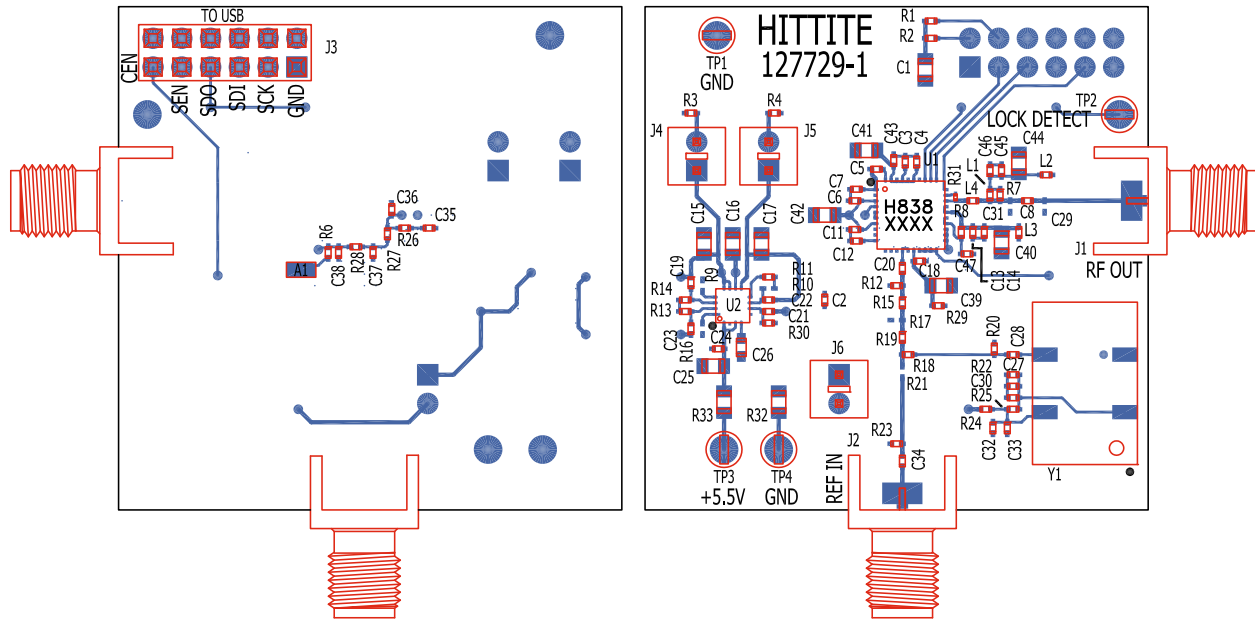
**FRACTIONAL-N PLL WITH INTEGRATED VCO**  
**795 - 945, 1590 - 1890, 3180 - 3780 MHz**
**Evaluation PCB, 2xfo Mode**

The circuit board used in the application should use RF circuit design techniques. Signal lines should have 50 Ohm impedance while the package ground leads and exposed paddle should be connected directly to the ground plane similar to that shown. A sufficient number of via holes should be used to connect the top and bottom ground planes. The evaluation circuit board shown is available from Hittite upon request.

**Evaluation PCB Schematic**

To view this [Evaluation PCB Schematic](#) please visit [www.hittite.com](http://www.hittite.com) and choose HMC838LP6CE from the "Search by Part Number" pull down menu to view the product splash page.

**FRACTIONAL-N PLL WITH INTEGRATED VCO  
795 - 945, 1590 - 1890, 3180 - 3780 MHz**
**List of Materials for  
Evaluation PCB 129512, 2xfo Mode [1]**

| Item  | Description                                   |
|---|---|
| J1, J2  | PCB Mount SMA RF Connector                    |
| J3  | Dual Row Terminal Strip                       |
| J4 - J6   | Connector Header                              |
| C1, C15 - C17, C25                                | 10 $\mu$ F Capacitor, 0805 Pkg.               |
| C2, C3, C6, C7, C11, C12, C14, C18, C27, C43, C45 | 0.47 $\mu$ F Capacitor, 0402 Pkg.             |
| C4, C13   | 22 pF Capacitor, 0402 Pkg.                    |
| C5, C33   | 1000 pF Capacitor, 0402 Pkg.                  |
| C8  | 8.2 pF Capacitor, 0402 Pkg.                   |
| C19 - C24, C28, C30, C32, C34                     | 0.1 $\mu$ F Capacitor, 0402 Pkg.              |
| C26   | 1 $\mu$ F Capacitor, 0603 Pkg.                |
| C29   | 1 pF Capacitor, 0402 Pkg.                     |
| C35   | 3300 pF Capacitor, 0402 Pkg.                  |
| C36   | 270 pF Capacitor, 0402 Pkg.                   |
| C37, C38  | 68 pF Capacitor, 0402 Pkg.                    |
| C39 - C42, C44                                    | 4.7 $\mu$ F Tantalum Capacitor, 0805 Pkg      |
| C46   | 27 pF Capacitor, 0402 Pkg.                    |
| C47   | 47 pF Capacitor, 0402 Pkg.                    |
| R1, R2, R8, R11, R15, R18, R19, R21, R24          | 0 Ohm Resistor, 0402 Pkg.                     |
| R3, R4  | 1 Ohm Resistor, 0402 Pkg.                     |
| R12, R20, R29                                     | 51 Ohm Resistor, 0402 Pkg.                    |
| R13, R14, R30                                     | 220 kOhm Resistor, 0402 Pkg.                  |
| R22, R25  | 20 kOhm Resistor, 0402 Pkg.                   |
| R26 - R28   | 1 kOhm Resistor, 0402 Pkg.                    |
| R31   | 0 Ohm Resistor, 0201 Pkg.                     |
| R32, R33  | 0 Ohm Resistor, 0805 Pkg.                     |
| L1  | 10 nH Inductor, 0402 Pkg.                     |
| L2, L3  | 47 nH Inductor, 0402 Pkg.                     |
| L4  | 1 nH Inductor, 0402 Pkg.                      |
| TP3, TP4  | Test Point PC Compact SMT                     |
| U1  | HMC838LP6CE PLL with Integrated VCO           |
| U2  | HMC860LP3E<br>Low Noise Quad Linear Regulator |
| Y1  | 3.3V, 50 MHz VCXO Crystal Oscillator          |
| PCB [2]   | 127729 Evaluation Board                       |

[1] Reference this number when ordering complete evaluation PCB

[2] Circuit Board Material: Rogers 4350 or Arlon 25FR and FR4

v05.0612

**FRACTIONAL-N PLL WITH INTEGRATED VCO**  
**795 - 945, 1590 - 1890, 3180 - 3780 MHz****Notes:**

Компания «Life Electronics» занимается поставками электронных компонентов импортного и отечественного производства от производителей и со складов крупных дистрибьюторов Европы, Америки и Азии.

С конца 2013 года компания активно расширяет линейку поставок компонентов по направлению коаксиальный кабель, кварцевые генераторы и конденсаторы (керамические, пленочные, электролитические), за счёт заключения дистрибьюторских договоров

Мы предлагаем:

- Конкурентоспособные цены и скидки постоянным клиентам.
- Специальные условия для постоянных клиентов.
- Подбор аналогов.
- Поставку компонентов в любых объемах, удовлетворяющих вашим потребностям.
- Приемлемые сроки поставки, возможна ускоренная поставка.
- Доставку товара в любую точку России и стран СНГ.
- Комплексную поставку.
- Работу по проектам и поставку образцов.
- Формирование склада под заказчика.
- Сертификаты соответствия на поставляемую продукцию (по желанию клиента).
- Тестирование поставляемой продукции.
- Поставку компонентов, требующих военную и космическую приемку.
- Входной контроль качества.
- Наличие сертификата ISO.

В составе нашей компании организован Конструкторский отдел, призванный помогать разработчикам, и инженерам.

Конструкторский отдел помогает осуществить:

- Регистрацию проекта у производителя компонентов.
- Техническую поддержку проекта.
- Защиту от снятия компонента с производства.
- Оценку стоимости проекта по компонентам.
- Изготовление тестовой платы монтаж и пусконаладочные работы.



Тел: +7 (812) 336 43 04 (многоканальный)

Email: [org@lifeelectronics.ru](mailto:org@lifeelectronics.ru)