

## ZXMHC10A07N8

### 100V SO8 Complementary enhancement mode MOSFET H-Bridge

#### Summary

Device	$V_{(BR)DSS}$	$Q_G$	$R_{DS(on)}$	$I_D$ $T_A = 25^\circ C$
N-CH	100V	2.9nC	$0.70\Omega @ V_{GS} = 10V$	1.0A
			$0.90\Omega @ V_{GS} = 6.0V$	0.9A
P-CH	-100V	3.5nC	$1.00\Omega @ V_{GS} = -10V$	-0.9A
			$1.45\Omega @ V_{GS} = -6.0V$	-0.7A

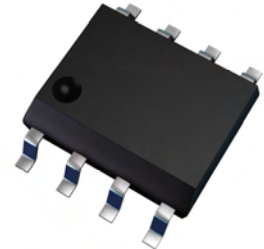

#### Description

This new generation complementary MOSFET H-Bridge features low on-resistance achievable with low gate drive.

#### Features

- 2 x N + 2 x P channels in a SOIC package

#### Applications

- DC Motor control
- DC-AC Inverters

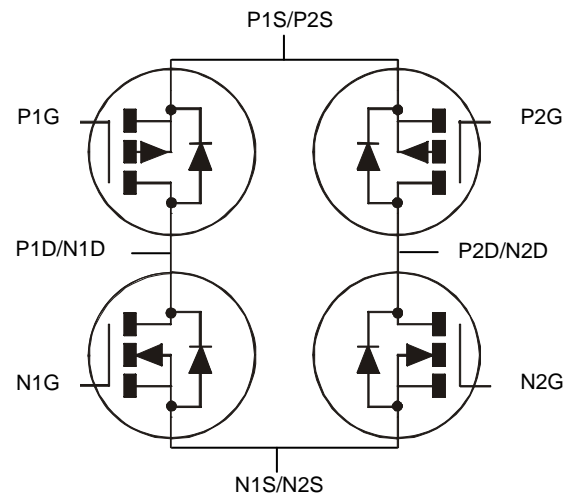

#### Ordering information

Device	Reel size (inches)	Tape width (mm)	Quantity per reel
ZXMHC10A07N8TC	13	12	2,500

#### Device marking

ZXMHC  
10A07

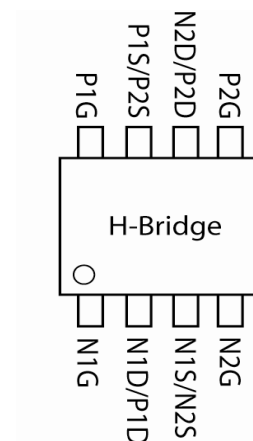

## Absolute maximum ratings

Parameter	Symbol	N-channel	P-channel	Unit
Drain-Source voltage	$V_{DSS}$	100	-100	V
Gate-Source voltage	$V_{GS}$	$\pm 20$	$\pm 20$	V
Continuous Drain current @ $V_{GS}=10V$ ; $T_A=25^\circ C$ <sup>(b)</sup> @ $V_{GS}=10V$ ; $T_A=70^\circ C$ <sup>(b)</sup> @ $V_{GS}=10V$ ; $T_A=25^\circ C$ <sup>(a)</sup> @ $V_{GS}=10V$ ; $T_L=25^\circ C$ <sup>(f)</sup>	$I_D$	1.00 0.80 0.80 0.81	-0.85 -0.68 -0.68 -0.69	A
Pulsed Drain current @ $V_{GS}=10V$ ; $T_A=25^\circ C$ <sup>(c)</sup>	$I_{DM}$	4.30	-3.64	A
Continuous Source current (Body diode) at $T_A=25^\circ C$ <sup>(b)</sup>	$I_S$	0.70	-0.60	A
Pulsed Source current (Body diode) at $T_A=25^\circ C$ <sup>(c)</sup>	$I_{SM}$	4.30	-3.64	A
Power dissipation at $T_A=25^\circ C$ <sup>(a)</sup> Linear derating factor	$P_D$	0.87 6.94		W mW/ $^\circ C$
Power dissipation at $T_A=25^\circ C$ <sup>(b)</sup> Linear derating factor	$P_D$	1.36 10.9		W mW/ $^\circ C$
Power dissipation at $T_L=25^\circ C$ <sup>(f)</sup> Linear derating factor	$P_D$	0.90 7.19		W mW/ $^\circ C$
Operating and storage temperature range	$T_j, T_{stg}$	-55 to 150		$^\circ C$

## Thermal resistance

Parameter	Symbol	Value	Unit
Junction to ambient <sup>(a)</sup>	$R_{\theta JA}$	144	$^\circ C/W$
Junction to ambient <sup>(b)</sup>	$R_{\theta JA}$	92	$^\circ C/W$
Junction to ambient <sup>(d)</sup>	$R_{\theta JA}$	106	$^\circ C/W$
Junction to ambient <sup>(e)</sup>	$R_{\theta JA}$	254	$^\circ C/W$
Junction to lead <sup>(f)</sup>	$R_{\theta JL}$	139	$^\circ C/W$

### NOTES:

- For a device surface mounted on 25mm x 25mm x 1.6mm FR4 PCB with high coverage of single sided 1oz copper, in still air conditions with the heat-sink split into two equal areas (one for each drain connection); the device is measured when operating in a steady-state condition with one active die.
- Same as note (a), except the device is measured at  $t \leq 10$  sec.
- Same as note (a), except the device is pulsed with  $D=0.02$  and pulse width 300  $\mu s$ . The pulse current is limited by the maximum junction temperature.
- For a device surface mounted on 50mm x 50mm x 1.6mm FR4 PCB with high coverage of single sided 2oz copper, in still air conditions with the heat-sink split into two equal areas (one for each drain connection); the device is measured when operating in a steady-state condition with one active die.
- For a device surface mounted on minimum copper 1.6mm FR4 PCB, in still air conditions; the device is measured when operating in a steady-state condition with one active die.
- Thermal resistance from junction to solder-point (at the end of the drain lead); the device is operating in a steady-state condition with one active die.

## Thermal characteristics

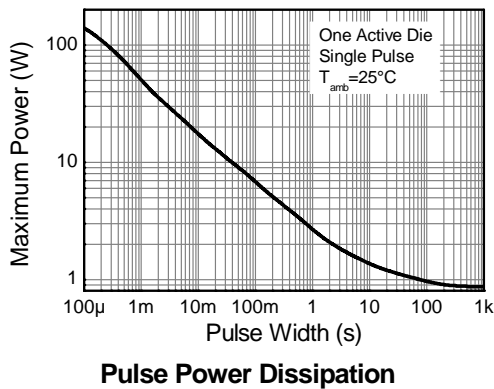
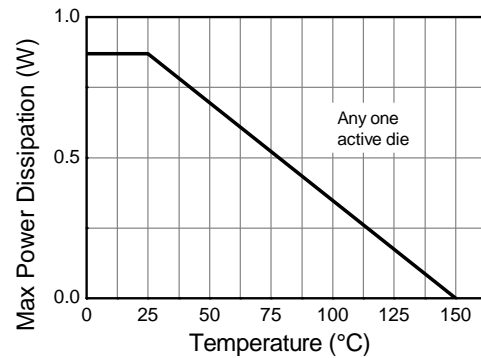
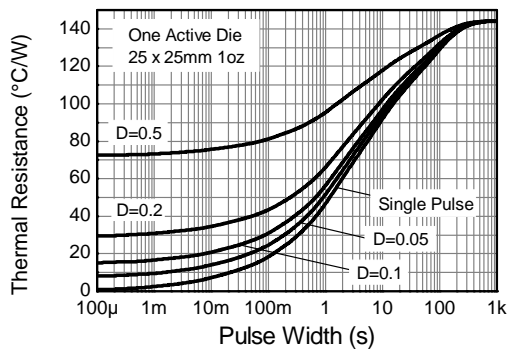
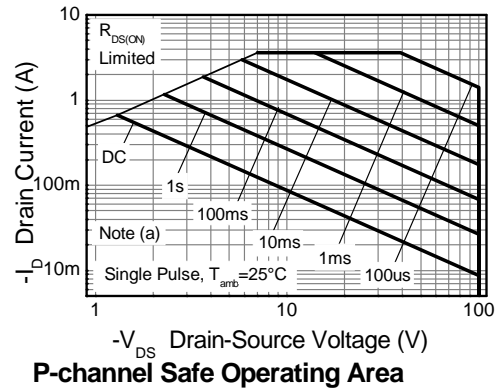
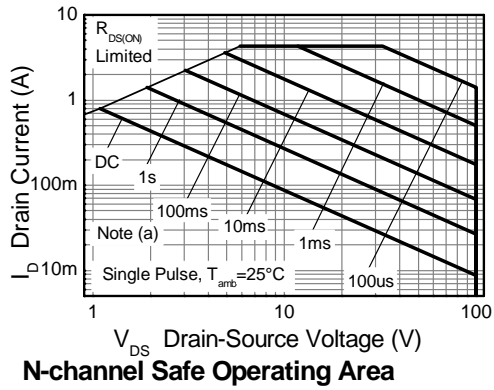

## N-channel electrical characteristics (at $T_{amb} = 25^{\circ}\text{C}$ unless otherwise stated)

Parameter	Symbol	Min.	Typ.	Max.	Unit	Conditions
<b>Static</b>						
Drain-Source breakdown voltage	$V_{(BR)DSS}$	100			V	$I_D = 250\mu\text{A}$ , $V_{GS} = 0\text{V}$
Zero Gate voltage Drain current	$I_{DSS}$			0.5	$\mu\text{A}$	$V_{DS} = 100\text{V}$ , $V_{GS} = 0\text{V}$
Gate-Body leakage	$I_{GSS}$			$\pm 100$	nA	$V_{GS} = \pm 20\text{V}$ , $V_{DS} = 0\text{V}$
Gate-Source threshold voltage	$V_{GS(th)}$	2.0		4.0	V	$I_D = 250\mu\text{A}$ , $V_{DS} = V_{GS}$
Static Drain-Source on-state resistance <sup>(a)</sup>	$R_{DS(on)}$			0.7 0.9	$\Omega$	$V_{GS} = 10\text{V}$ , $I_D = 1.5\text{A}$ $V_{GS} = 6.0\text{V}$ , $I_D = 1.0\text{A}$
Forward Transconductance <sup>(a) (c)</sup>	$g_{fs}$		1.6		S	$V_{DS} = 15\text{V}$ , $I_D = 1.0\text{A}$
<b>Dynamic</b>						
<b>Capacitance</b> <sup>(c)</sup>						
Input capacitance	$C_{iss}$		138		pF	$V_{DS} = 60\text{V}$ , $V_{GS} = 0\text{V}$ $f = 1\text{MHz}$
Output capacitance	$C_{oss}$		12		pF	
Reverse transfer capacitance	$C_{rss}$		6		pF	
<b>Switching</b> <sup>(b) (c)</sup>						
Turn-on-delay time	$t_{d(on)}$		1.8		ns	$V_{DD} = 50\text{V}$ , $V_{GS} = 10\text{V}$ $I_D = 1.0\text{A}$ $R_G \cong 6.0\Omega$ ,
Rise time	$t_r$		1.5		ns	
Turn-off delay time	$t_{d(off)}$		4.1		ns	
Fall time	$t_f$		2.1		ns	
<b>Gate charge</b> <sup>(c)</sup>						
Total Gate charge	$Q_g$		2.9		nC	$V_{DS} = 50\text{V}$ , $V_{GS} = 10\text{V}$ $I_D = 1.0\text{A}$
Gate-Source charge	$Q_{gs}$		0.7		nC	
Gate-Drain charge	$Q_{gd}$		1.0		nC	
<b>Source-Drain diode</b>						
Diode forward voltage <sup>(a)</sup>	$V_{SD}$			0.95	V	$I_S = 1.5\text{A}$ , $V_{GS} = 0\text{V}$
Reverse recovery time <sup>(c)</sup>	$t_{rr}$		27		ns	$I_S = 1.8\text{A}$ , $di/dt = 100\text{A}/\mu\text{s}$
Reverse recovery charge <sup>(c)</sup>	$Q_{rr}$		12		nC	

### NOTES:

- (a) Measured under pulsed conditions. Pulse width  $\leq 300\mu\text{s}$ ; duty cycle  $\leq 2\%$ .  
 (b) Switching characteristics are independent of operating junction temperature.  
 (c) For design aid only, not subject to production testing

## N-channel typical characteristics

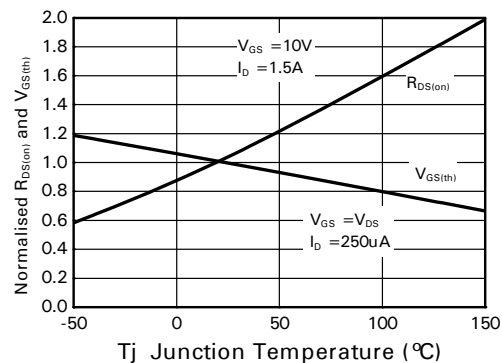
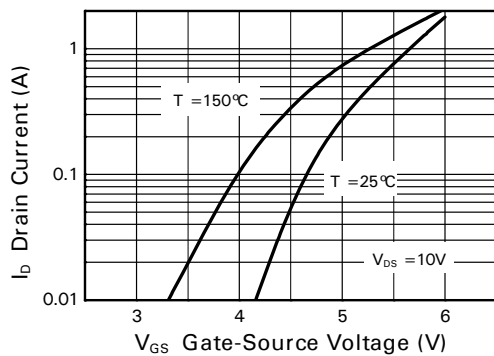
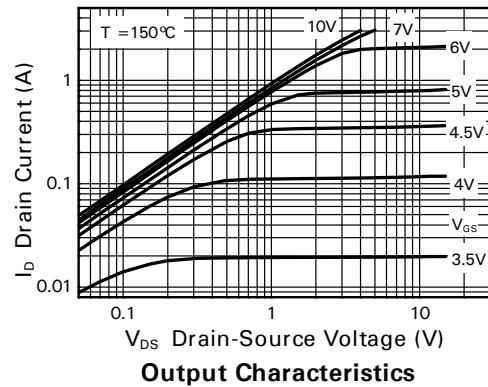
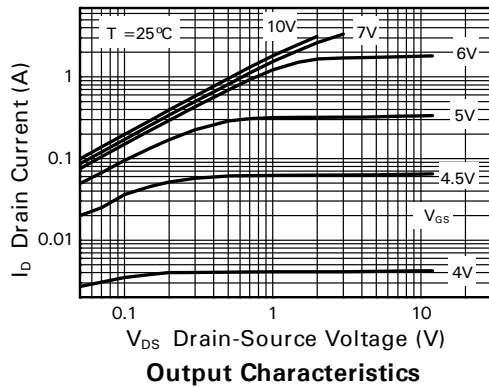

Typical Transfer Characteristics

Normalised Curves v Temperature

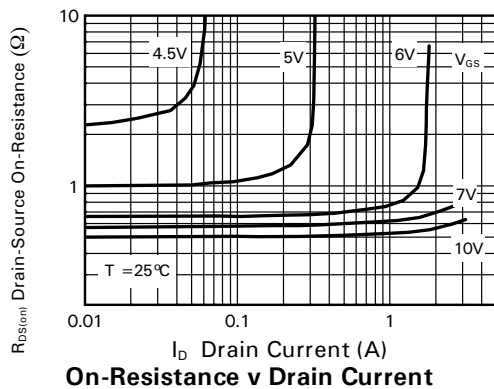

On-Resistance v Drain Current

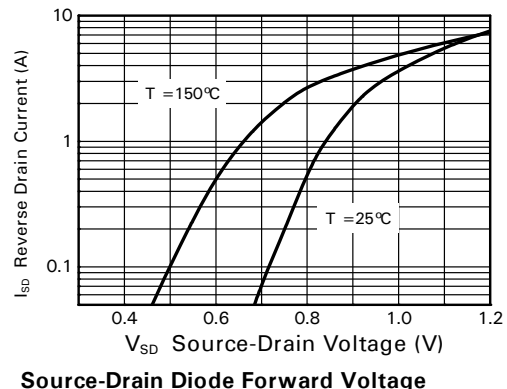

Source-Drain Diode Forward Voltage

## N-channel typical characteristics –continued

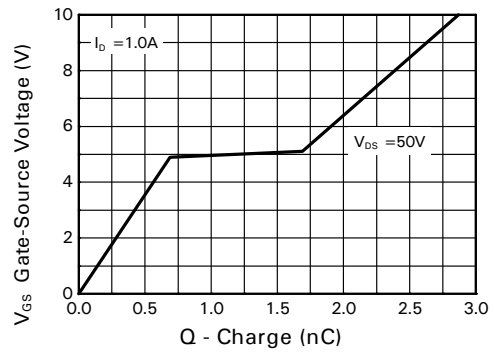
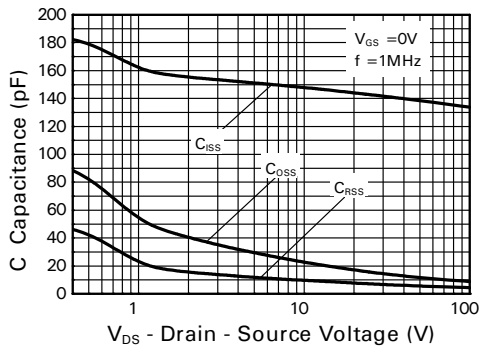

## Test circuits

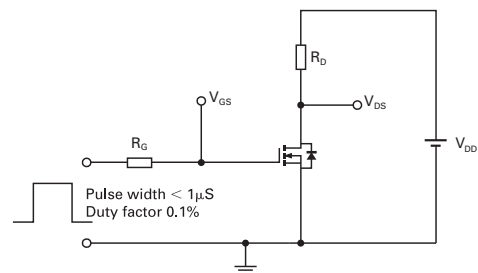
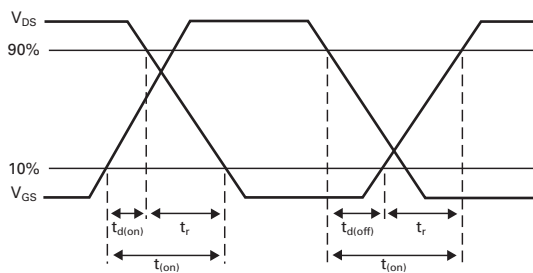
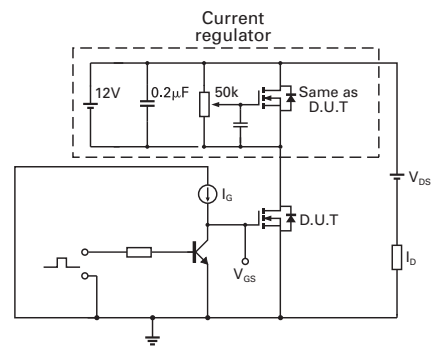
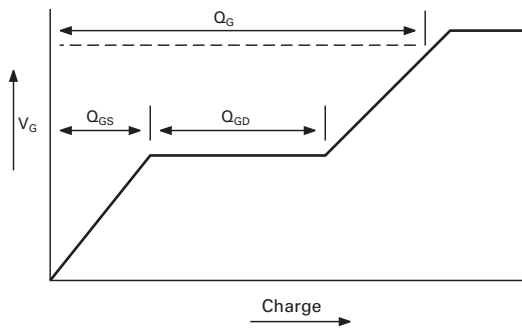

## P-channel electrical characteristics (at $T_{amb} = 25^{\circ}\text{C}$ unless otherwise stated)

Parameter	Symbol	Min.	Typ.	Max.	Unit	Conditions
<b>Static</b>						
Drain-Source breakdown voltage	$V_{(BR)DSS}$	-100			V	$I_D = -250\mu\text{A}$ , $V_{GS} = 0\text{V}$
Zero Gate voltage Drain current	$I_{DSS}$			-0.5	$\mu\text{A}$	$V_{DS} = -100\text{V}$ , $V_{GS} = 0\text{V}$
Gate-Body leakage	$I_{GSS}$			$\pm 100$	nA	$V_{GS} = \pm 20\text{V}$ , $V_{DS} = 0\text{V}$
Gate-Source threshold voltage	$V_{GS(th)}$	-2.0		-4.0	V	$I_D = -250\mu\text{A}$ , $V_{DS} = V_{GS}$
Static Drain-Source on-state resistance <sup>(a)</sup>	$R_{DS(on)}$			1.0 1.45	$\Omega$	$V_{GS} = -10\text{V}$ , $I_D = -0.6\text{A}$ $V_{GS} = -6.0\text{V}$ , $I_D = -0.5\text{A}$
Forward Transconductance <sup>(a) (c)</sup>	$g_{fs}$		1.2		S	$V_{DS} = -15\text{V}$ , $I_D = -0.6\text{A}$
<b>Dynamic</b>						
<b>Capacitance <sup>(c)</sup></b>						
Input capacitance	$C_{iss}$		141		pF	$V_{DS} = -50\text{V}$ , $V_{GS} = 0\text{V}$ $f = 1\text{MHz}$
Output capacitance	$C_{oss}$		13.1		pF	
Reverse transfer capacitance	$C_{rss}$		10.8		pF	
<b>Switching <sup>(b) (c)</sup></b>						
Turn-on-delay time	$t_{d(on)}$		1.6		ns	$V_{DD} = -50\text{V}$ , $V_{GS} = -10\text{V}$ $I_D = -1.0\text{A}$ $R_G \cong 6.0\Omega$
Rise time	$t_r$		2.1		ns	
Turn-off delay time	$t_{d(off)}$		5.9		ns	
Fall time	$t_f$		3.3		ns	
<b>Gate charge <sup>(c)</sup></b>						
Total Gate charge	$Q_g$		3.5		nC	$V_{DS} = -50\text{V}$ , $V_{GS} = -10\text{V}$ $I_D = -0.6\text{A}$
Gate-Source charge	$Q_{gs}$		0.6		nC	
Gate-Drain charge	$Q_{gd}$		1.6		nC	
<b>Source-Drain diode</b>						
Diode forward voltage <sup>(a)</sup>	$V_{SD}$		-0.85	-0.95	V	$I_S = -0.7\text{A}$ , $V_{GS} = 0\text{V}$
Reverse recovery time <sup>(c)</sup>	$t_{rr}$		29		ns	$I_S = -0.9\text{A}$ , $di/dt = 100\text{A}/\mu\text{s}$
Reverse recovery charge <sup>(c)</sup>	$Q_{rr}$		31		nC	

### NOTES:

- (a) Measured under pulsed conditions. Pulse width  $\leq 300\mu\text{s}$ ; duty cycle  $\leq 2\%$ .  
 (b) Switching characteristics are independent of operating junction temperature.  
 (c) For design aid only, not subject to production testing

## P-channel typical characteristics

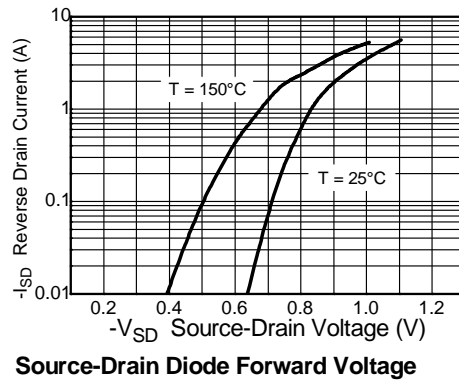
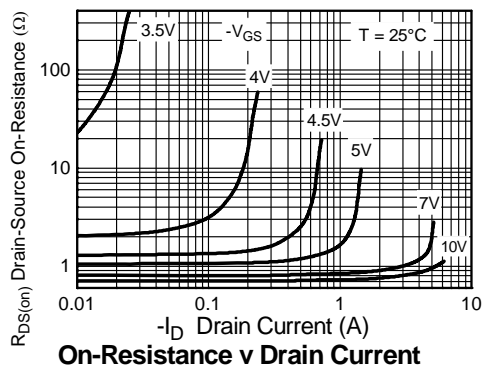
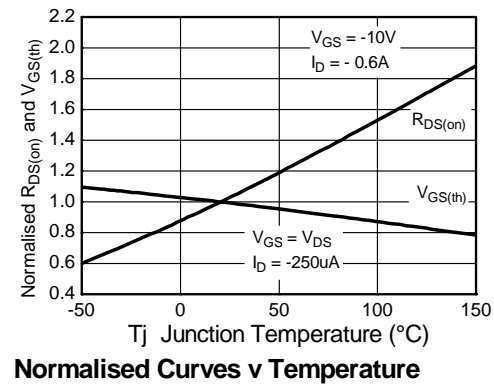
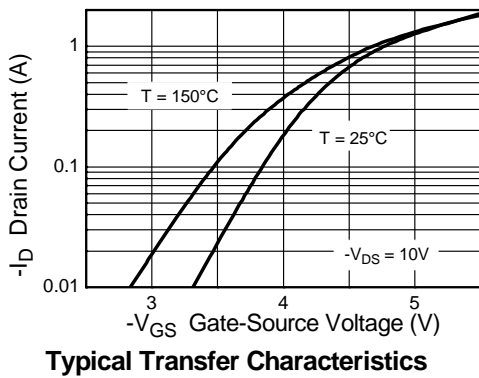
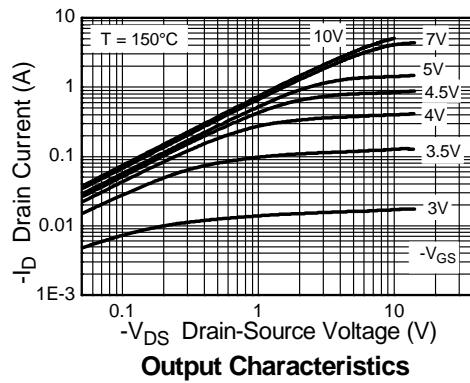
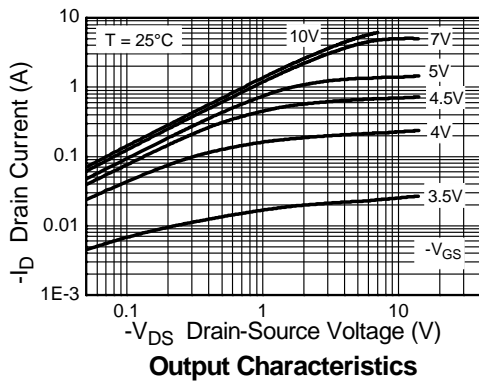



## P-channel typical characteristics –continued

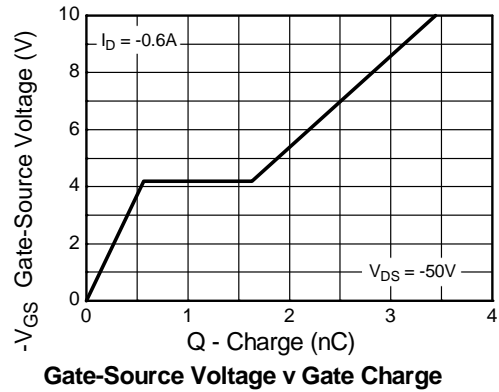
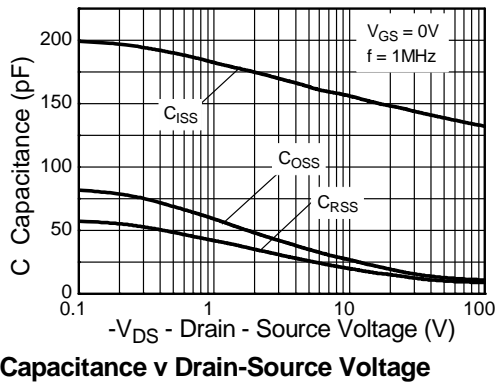

## Test circuits

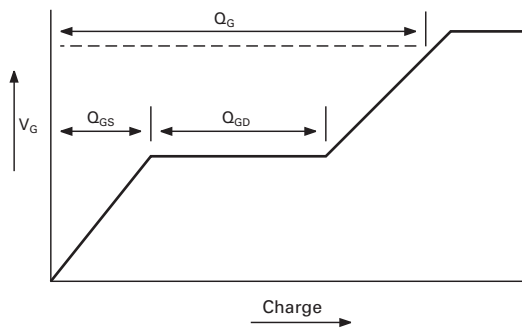

**Basic gate charge waveform**

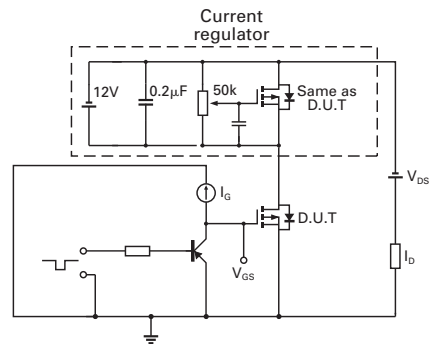

**Gate charge test circuit**

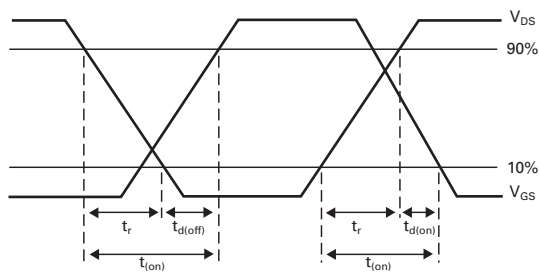

**Switching time waveforms**

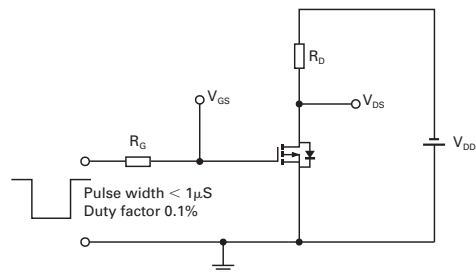

**Switching time test circuit**

## Packaging details - SO8

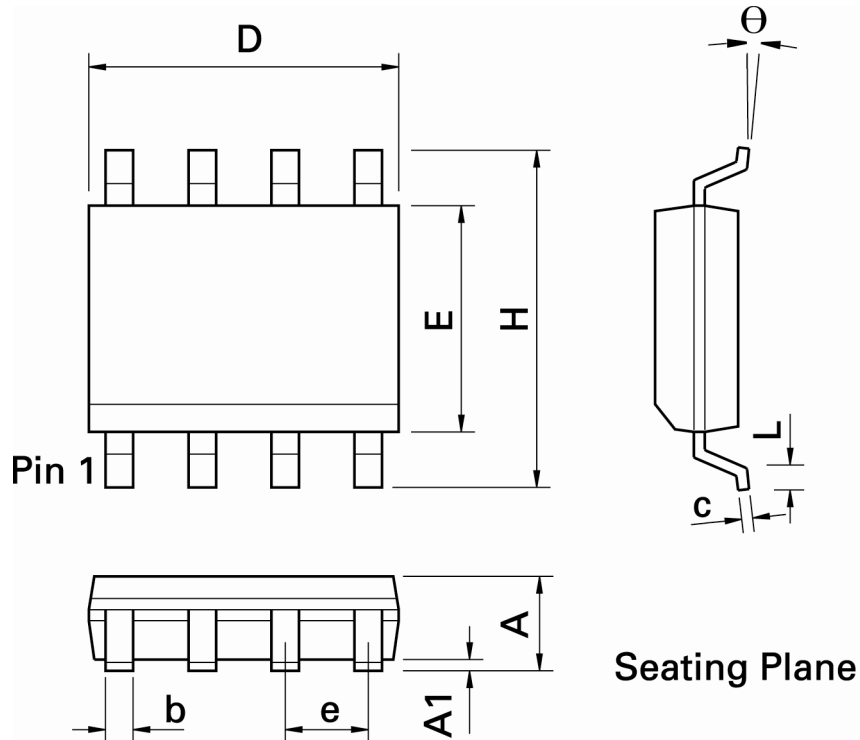

DIM	Inches		Millimeters		DIM	Inches		Millimeters	
	Min.	Max.	Min.	Max.		Min.	Max.	Min.	Max.
A	0.053	0.069	1.35	1.75	e	0.050 BSC		1.27 BSC	
A1	0.004	0.010	0.10	0.25	b	0.013	0.020	0.33	0.51
D	0.189	0.197	4.80	5.00	c	0.008	0.010	0.19	0.25
H	0.228	0.244	5.80	6.20	θ	0°	8°	0°	8°
E	0.150	0.157	3.80	4.00	-	-	-	-	-
L	0.016	0.050	0.40	1.27	-	-	-	-	-

**Note:** Controlling dimensions are in inches. Approximate dimensions are provided in millimeters

## IMPORTANT NOTICE

DIODES INCORPORATED MAKES NO WARRANTY OF ANY KIND, EXPRESS OR IMPLIED, WITH REGARDS TO THIS DOCUMENT, INCLUDING, BUT NOT LIMITED TO, THE IMPLIED WARRANTIES OF MERCHANTABILITY AND FITNESS FOR A PARTICULAR PURPOSE (AND THEIR EQUIVALENTS UNDER THE LAWS OF ANY JURISDICTION).

Diodes Incorporated and its subsidiaries reserve the right to make modifications, enhancements, improvements, corrections or other changes without further notice to this document and any product described herein. Diodes Incorporated does not assume any liability arising out of the application or use of this document or any product described herein; neither does Diodes Incorporated convey any license under its patent or trademark rights, nor the rights of others. Any Customer or user of this document or products described herein in such applications shall assume all risks of such use and will agree to hold Diodes Incorporated and all the companies whose products are represented on Diodes Incorporated website, harmless against all damages.

Diodes Incorporated does not warrant or accept any liability whatsoever in respect of any products purchased through unauthorized sales channel.

Should Customers purchase or use Diodes Incorporated products for any unintended or unauthorized application, Customers shall indemnify and hold Diodes Incorporated and its representatives harmless against all claims, damages, expenses, and attorney fees arising out of, directly or indirectly, any claim of personal injury or death associated with such unintended or unauthorized application.

Products described herein may be covered by one or more United States, international or foreign patents pending. Product names and markings noted herein may also be covered by one or more United States, international or foreign trademarks.

## LIFE SUPPORT

Diodes Incorporated products are specifically not authorized for use as critical components in life support devices or systems without the express written approval of the Chief Executive Officer of Diodes Incorporated. As used herein:

A. Life support devices or systems are devices or systems which:

1. are intended to implant into the body, or
2. support or sustain life and whose failure to perform when properly used in accordance with instructions for use provided in the labeling can be reasonably expected to result in significant injury to the user.

B. A critical component is any component in a life support device or system whose failure to perform can be reasonably expected to cause the failure of the life support device or to affect its safety or effectiveness.

Customers represent that they have all necessary expertise in the safety and regulatory ramifications of their life support devices or systems, and acknowledge and agree that they are solely responsible for all legal, regulatory and safety-related requirements concerning their products and any use of Diodes Incorporated products in such safety-critical, life support devices or systems, notwithstanding any devices- or systems-related information or support that may be provided by Diodes Incorporated. Further, Customers must fully indemnify Diodes Incorporated and its representatives against any damages arising out of the use of Diodes Incorporated products in such safety-critical, life support devices or systems.

Copyright © 2009, Diodes Incorporated

[www.diodes.com](http://www.diodes.com)

Компания «Life Electronics» занимается поставками электронных компонентов импортного и отечественного производства от производителей и со складов крупных дистрибьюторов Европы, Америки и Азии.

С конца 2013 года компания активно расширяет линейку поставок компонентов по направлению коаксиальный кабель, кварцевые генераторы и конденсаторы (керамические, пленочные, электролитические), за счёт заключения дистрибьюторских договоров

Мы предлагаем:

- Конкурентоспособные цены и скидки постоянным клиентам.
- Специальные условия для постоянных клиентов.
- Подбор аналогов.
- Поставку компонентов в любых объемах, удовлетворяющих вашим потребностям.
- Приемлемые сроки поставки, возможна ускоренная поставка.
- Доставку товара в любую точку России и стран СНГ.
- Комплексную поставку.
- Работу по проектам и поставку образцов.
- Формирование склада под заказчика.
- Сертификаты соответствия на поставляемую продукцию (по желанию клиента).
- Тестирование поставляемой продукции.
- Поставку компонентов, требующих военную и космическую приемку.
- Входной контроль качества.
- Наличие сертификата ISO.

В составе нашей компании организован Конструкторский отдел, призванный помогать разработчикам, и инженерам.

Конструкторский отдел помогает осуществить:

- Регистрацию проекта у производителя компонентов.
- Техническую поддержку проекта.
- Защиту от снятия компонента с производства.
- Оценку стоимости проекта по компонентам.
- Изготовление тестовой платы монтаж и пусконаладочные работы.



Тел: +7 (812) 336 43 04 (многоканальный)

Email: [org@lifeelectronics.ru](mailto:org@lifeelectronics.ru)