

EAO – Your Expert Partner for
Human Machine Interfaces

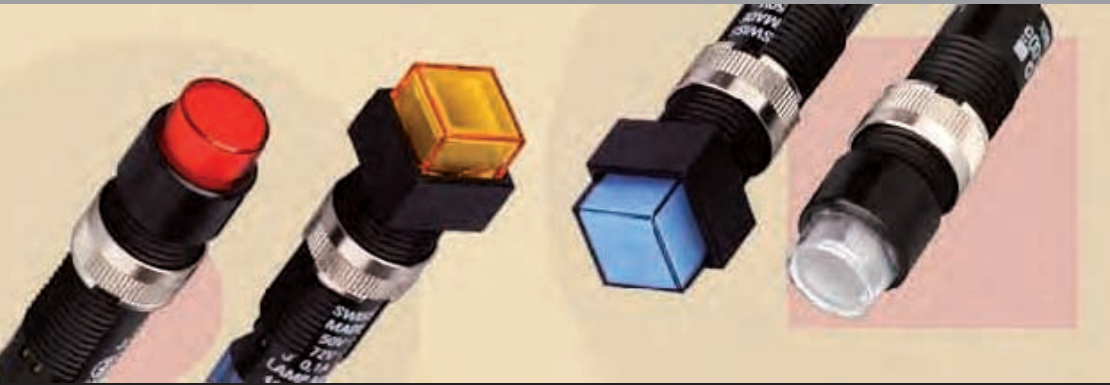

EAO Product Information

Series 19



Description	3
Product Assembly	4
Devices raised mounting	5
Accessories.....	6
Technical Data.....	9
Application guidelines.....	11
Drawings.....	12
Index.....	15

Product Information

General notes

The series contains indicators and illuminated pushbuttons with maintained and momentary action and one contact which may be normally closed or normally open (snap-action element for closing). The illuminated pushbuttons are fitted with snap-action or low-level switching systems.

The front dimensions are 9 x 9 mm or 9 mm dia.

Mounting

Mounting from the front through the mounting hole is assured even when the wiring has already been attached.

The units are equipped with soldering/plug-in terminals.

Lenses

The flat lenses, made of polycarbonate, are obtainable in various colours. The transparent lens is available with translucent or transparent support.

Marking

A limited amount of marking can be provided.

Illumination

Perfect illumination of the different coloured lenses is assured by filament lamps Bi-Pin T1 longlife (6 ... 24 V) or LED Bi-Pin T1. LED are available in the colours white, red, yellow, orange and green.

Luminosity and wave length scattering caused by the technology used in the LED manufacturing processes may lead to visual differences in our products.

Position indication

The status of a maintained action switch can be determined by the position of the lens.

Specimen order

Indicator :

- Indicator actuator, 9 mm dia., soldering terminal 19-030.005

Essential accessories :

- Lens plastic blue, transparent, flush, 9 mm dia. 19-931.6
- Single-LED, T1 Bi-Pin, 3.6 VDC, weiss 10-2603.3179C

*We reserve the right to modify technical data
All dimensions in mm*

Indicator, raised mounting

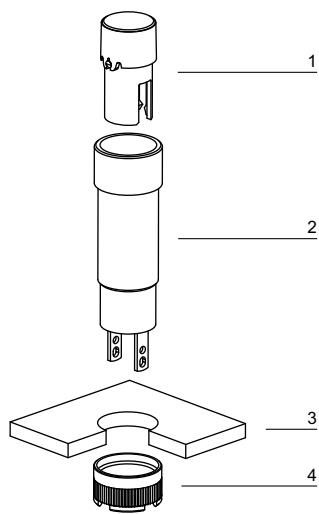

- 1 Lens
- 2 Switch housing
- 3 Front plate
- 4 Fixing nut

Pushbutton illuminative, raised mounting

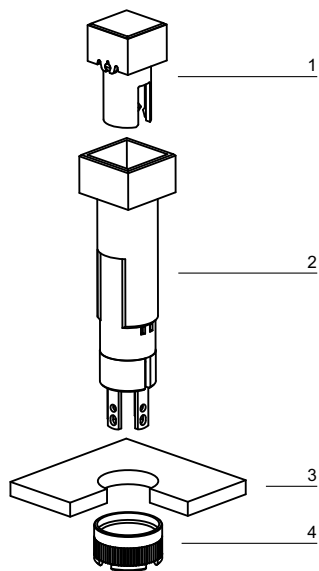

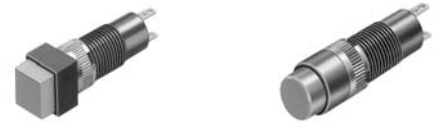

- 1 Lens
- 2 Switch housing
- 3 Front plate
- 4 Fixing nut

Indicator actuator



Essential Accessories:

-  Lens page 6
-  Single-LED page 7

	Front protection	Terminals	9 x 9 mm Typ-Nr.	Ø 9 mm Typ-Nr.	Component layout	Mounting dimensions	Technical drawing	Circuit drawing	
Indicator actuator Mounting depth : 25 mm	IP 40	S2	19-050.005	19-030.005	1	1	1	1	0.001
Mounting depth : 33 mm	IP 40	S2	19-051.005	19-031.005	1	1	3	1	0.002



Terminals: S2 = Soldering terminal (also pluggable 2.0 x 0.5 mm)

Component layout from page 12, Mounting dimensions from page 12, Technical drawing from page 13, Circuit drawing from page 14

Illuminated pushbutton actuator



Essential Accessories:

-  Lens page 6
-  Single-LED page 7

	Front protection	Switching system	Contact material	Contacts	Switching action	Terminals	9 x 9 mm Typ-Nr.	Ø 9 mm Typ-Nr.	Component layout	Mounting dimensions	Technical drawing	Circuit drawing	
Illuminated pushbutton actuator	IP 40	LL	Au	1 NC	MA	S2	19-482.035	19-472.035	2	1	2	2	0.002
					M	S2	19-452.035	19-432.035	2	1	2	4	0.002
				1 NO	MA	S2	19-481.035	19-471.035	2	1	2	3	0.002
					M	S2	19-451.035	19-431.035	2	1	2	5	0.002
		SA	Au	1 NO	MA	S2	19-289.035	19-279.035	2	1	2	3	0.002
					M	S2	19-159.035	19-139.035	2	1	2	5	0.002
			Ag	1 NO	MA	S2	19-289.015	19-279.015	2	1	2	3	0.002
					M	S2	19-159.015	19-139.015	2	1	2	5	0.002

Switching system: LL = Low level switching element, SA = Snap-action switching element

Contact material: Au = Gold, Ag = Silver

Contacts: NC = Normally closed, NO = Normally open

Switching action: MA = Maintained action, M = Momentary action

Terminals: S2 = Soldering terminal (also pluggable 2.0 x 0.5 mm)

Component layout from page 12, Mounting dimensions from page 12, Technical drawing from page 13, Circuit drawing from page 14

Front

Lens

	Lens	∅ 9 x 9 mm Typ-Nr.	∅ 9 mm Typ-Nr.	
Lens illuminative, holder translucent	Plastic flush transparent blue	19-951.6	19-931.6	0.001
	Plastic flush transparent green	19-951.5	19-931.5	0.001
	Plastic flush transparent red	19-951.2	19-931.2	0.001
	Plastic flush transparent white	19-951.9	19-931.9	0.001
	Plastic flush transparent yellow	19-951.4	19-931.4	0.001
illuminative (not recommended for film insert), holder transparent	Plastic flush transparent blue	19-952.6	19-932.6	0.001
	Plastic flush transparent colourless	19-952.7	19-932.7	0.001
	Plastic flush transparent green	19-952.5	19-932.5	0.001
	Plastic flush transparent red	19-952.2	19-932.2	0.001
	Plastic flush transparent yellow	19-952.4	19-932.4	0.001
non-illuminative	Plastic flush opaque black	19-951.0	19-931.0	0.001
	Plastic flush opaque grey	19-951.8	19-931.8	0.001



Blind plug

	Blind plug	∅ 9 x 9 mm Typ-Nr.	∅ 9 mm Typ-Nr.	Mounting dimensions	
Blind plug	Plastic black	19-948.0	19-949.0	1	0.001



Mounting dimensions from page 12

Backside

PCB plug-in base

	Terminals	Typ-Nr.	Component layout	Technical drawing	
PCB plug-in base Pins axial	P	19-940	3	4	0.001
Pins bent at right-angles	P	19-941	4	5	0.001



Terminals: P = PCB terminal

Component layout from page 12, Technical drawing from page 13

Flat receptacle

	Typ-Nr.	
Flat receptacle 2.0 x 0.5 mm	31-945	0.001



Insulation sleeve

	Typ-Nr.	
Insulation sleeve for Flat receptacle 31-945	31-928	0.001



Illumination

Filament lamp

	Socket	Operating voltage/-current	Typ-Nr.	
Filament lamp max. PIN length 5 mm	T1 Bi-Pin	12 VAC/DC, 25 mA	10-1609.1199	0.001
		24 VAC/DC, 20 mA	10-1612.1179	0.001
		6 VAC/DC, 70 mA	10-1606.1309	0.001



Single-LED

	Socket	Light colour	Operating voltage/-current	Typ-Nr.	
Single-LED max. PIN length 8 mm	T1 Bi-Pin	green	2.2 VDC, 20 mA	10-2602.3175C	0.001
		red	2.2 VDC, 20 mA	10-2602.3172C	0.001
		white	3.6 VDC, 20 mA	10-2603.3179C	0.001
		yellow	2.2 VDC, 20 mA	10-2602.3174C	0.001



Multi-LED

	Socket	Light colour	Operating voltage/-current	Typ-Nr.	
Multi-LED max. PIN length 5 mm	T1 Bi-Pin	green	28 VDC, 12 mA	10-4613.3105B	0.001
		orange	28 VDC, 12 mA	10-4613.3103B	0.001
		red	28 VDC, 12 mA	10-4613.3102B	0.001
		yellow	28 VDC, 12 mA	10-4613.3104B	0.001



Assembling

Fixing nut

	Typ-Nr.	 kg
Fixing nut Ø 9/M8 x 13 mm	19-991	0.001



Dressing tool

	Typ-Nr.	 kg
Dressing tool for aligning buttons	19-906	0.011



Lens remover

	Typ-Nr.	 kg
Lens remover	19-910	0.002



Lamp remover

	Typ-Nr.	 kg
Lamp remover	11-906	0.003



CAUTION
A switching process might be released when replacing the Lamp/LED !

Mounting tool

	Typ-Nr.	 kg
Mounting tool for Fixing nut long 19-991	19-905	0.011



Actuator with snap-action switching element

Switching system

Single-break, snap-action switching system.
1 normally open contact

Material

Material of contact

Gold plated Silver, Silver plated

Switch housing

Polyetherimide (PEI), self-extinguishing

Actuator housing

Polyphenyleneoxide (PPO), self-extinguishing, colour black

Mechanical characteristics

Terminals

Universal terminal:
Max. wire diameter 2 x 0.8 mm
Max. wire cross-section of stranded cable 1 x 0.75 mm²

Plug-in terminal: 2.0 x 0.5 mm
For these terminals we can also supply a plug-in base which, when soldered on to the board, enables the switch to be plugged in.

Tightening torque

for fixing nut max. 20 Ncm

Actuating force

1.6 N

Actuating travel

2.8 mm ±0.2 mm

Mechanical lifetime

2 million operations

Electrical characteristics

Switch rating

Silver plated:
Max. 50 VAC / 72 VDC, 0.8 A or 50 W
Min. 20 V, 10 mA
Gold plated:
Max. 50 VAC / 72 VDC, 100 mA or 5 W
Min. 100 µV, 50 µA

Electric strength

2500 VAC, 50 Hz, 1 min. between all terminals and earth, as per IEC 60512-2-11

Environmental conditions

Storage temperature

-40 °C ... +85 °C

Service temperature

without illumination -25 °C ... +65 °C
with incandescent lamp -25 °C ... +45 °C
with LED -25 °C ... +65 °C
for indicators and illuminated pushbuttons mounted as a block, make sure the heat can escape freely

Protection degree

IP 40 front side, as per IEC 60529

Actuator with low level switching element

Switching system

This low-level switching system was designed for switching low powers in electronic circuits. The switching system assures reliable switching of loads.
Single-break momentary contact, as normally open or normally closed with 4 independent points of contact.
Special features are the long life, extremely short rebound time and stable contact resistance.
1 normally open or 1 normally closed contact.

Material

Material of contact

Gold plated

Actuator housing

Polyphenyleneoxide (PPO), self-extinguishing, colour black

Mechanical characteristics

Terminals

Universal terminal:
Max. wire diameter 2 x 0.8 mm
Max. wire cross-section of stranded cable 1 x 0.75 mm²

Plug-in terminal: 2.0 x 0.5 mm
For these terminals we can also supply a plug-in base which, when soldered on to the board, enables the switch to be plugged in.

Tightening torque

for fixing nut max. 20 Ncm

Actuating force

1.8 N ±0.3 N

Actuating travel

2.8 mm ±0.2 mm

Rebound time

Typ. <100 µs

Mechanical lifetime

5 million operations

Electrical characteristics

Contact resistance

≤50 mΩ starting value (initial) as per IEC 60512-2-2b

Switch rating

10 µA, 100 µV to 100 mA at 42 VAC/VDC

Electric strength

2500 VAC, 50 Hz, 1 min. between all terminals and earth, as per IEC 60512-2-11

Environmental conditions

Storage temperature

-40 °C ... +85 °C

Service temperature

without illumination -25 °C ... +65 °C
with incandescent lamp -25 °C ... +45 °C
with LED -25 °C ... +65 °C

for indicators and illuminated pushbuttons mounted as a block,
make sure the heat can escape freely

Protection degree

IP 40 front side, as per IEC 60529

Shock resistance

(Single impacts, semi-sinusoidal)

15 g for 11 ms, as per IEC 60512-4-3, IEC 60068-2-27

Suppressor circuits

When switching inductive loads such as relays, DC motors, and DC solenoids, it is always important to absorb surges (e.g. with a diode) to protect the contacts. When these inductive loads are switched off, a counter emf can severely damage switch contacts and greatly shorten lifetime.

Fig. 1 shows an inductive load with a free-wheeling diode connected in parallel. This free-wheeling diode provides a path for the inductor current to flow when the current is interrupted by the switch. Without this free-wheeling diode, the voltage across the coil will be limited only by dielectric breakdown voltages of the circuit or parasitic elements of the coil. This voltage can be kilovolts in amplitude even when nominal circuit voltages are low (e.g. 12 VDC) see Fig. 2.

The free-wheeling diode should be chosen so that the reverse breakdown voltage is greater than the voltage driving the inductive load. The DC blocking voltage (V_R) of the free-wheeling diode can be found in the datasheet of a diode. The forward current should be equal or greater than the maximum current flowing through the load.

To get an efficient protection, the free-wheeling diode must be connected as close as possible to the inductive load!

Switching with inductive load
Fig. 1

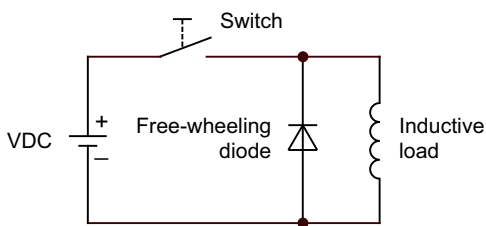

Counter emf
over load without free-wheeling diode
Fig. 2

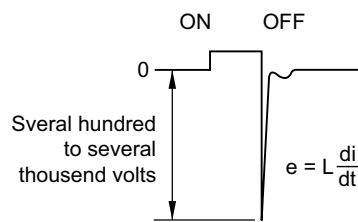

Component layout

1 Indicator actuator page 5

9 x 9 mm Ø9 mm

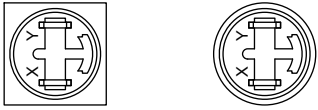

2 Illuminated pushbutton actuator page 5

9 x 9 mm Ø9 mm

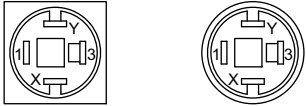

3 PCB plug-in base page 6

Drilling plan (element side)
Through-connection recommended

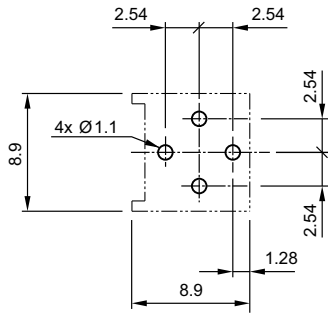

4 PCB plug-in base page 6

Drilling plan (element side)
Through-connection recommended

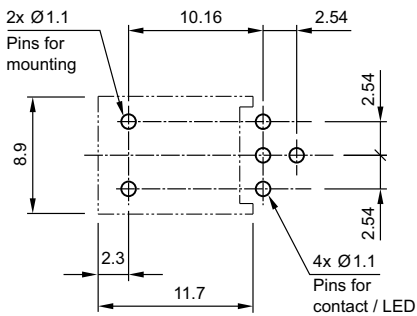

Mounting dimensions

1 Indicator actuator page 5 | Illuminated pushbutton actuator page 5 | Blind plug page 6

9 x 9 mm Ø9 mm

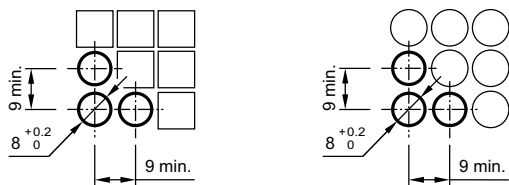

Technical drawing

1 Indicator actuator page 5

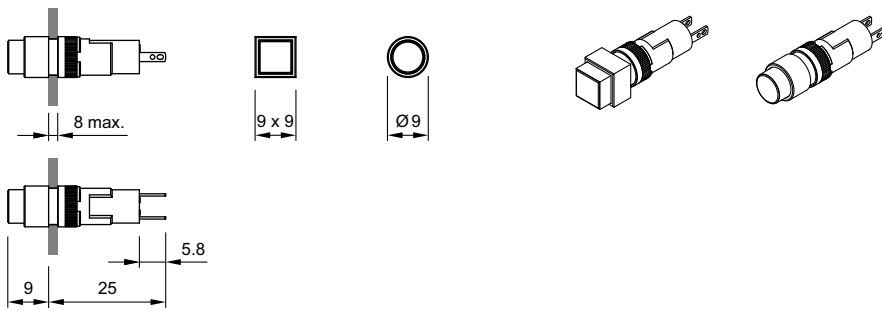

2 Illuminated pushbutton actuator page 5

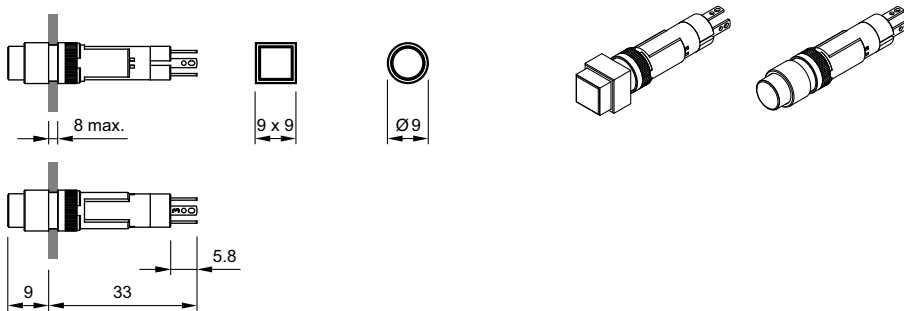

3 Indicator actuator page 5

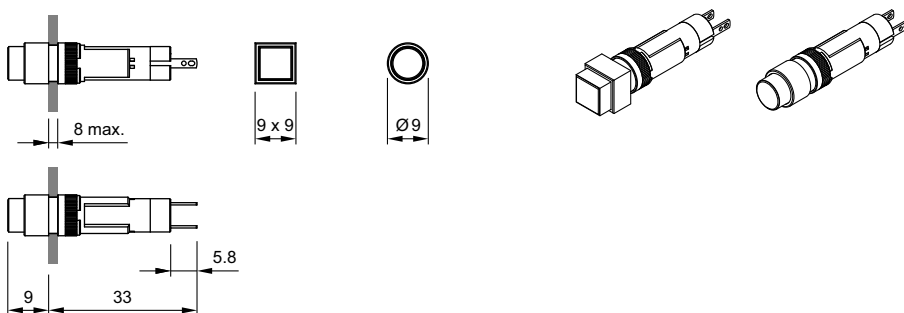

4 PCB plug-in base page 6

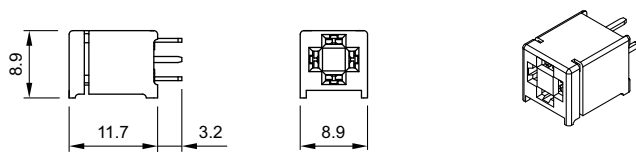

5 PCB plug-in base page 6

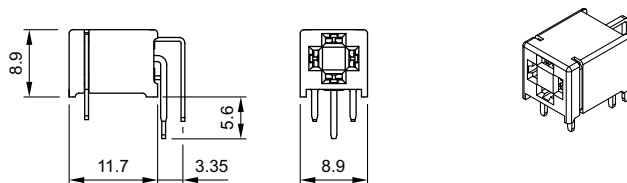

Circuit drawing

1 Indicator actuator page 5



2 Illuminated pushbutton actuator page 5

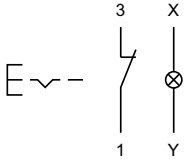

3 Illuminated pushbutton actuator page 5

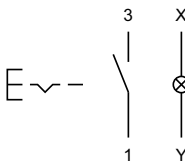

4 Illuminated pushbutton actuator page 5

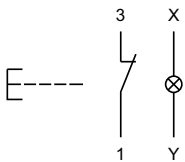

5 Illuminated pushbutton actuator page 5

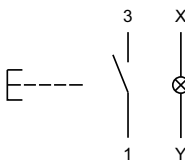

Index from Typ-Nr.

Typ-Nr.	Page	Typ-Nr.	Page	Typ-Nr.	Page
10-1606.1309	7	19-991	8		
10-1609.1199	7	31-928	7		
10-1612.1179	7	31-945	7		
10-2602.3172C	7				
10-2602.3174C	7				
10-2602.3175C	7				
10-2603.3179C	7				
10-4613.3102B	7				
10-4613.3103B	7				
10-4613.3104B	7				
10-4613.3105B	7				
11-906	8				
19-030.005	5				
19-031.005	5				
19-050.005	5				
19-051.005	5				
19-139.015	5				
19-139.035	5				
19-159.015	5				
19-159.035	5				
19-279.015	5				
19-279.035	5				
19-289.015	5				
19-289.035	5				
19-431.035	5				
19-432.035	5				
19-451.035	5				
19-452.035	5				
19-471.035	5				
19-472.035	5				
19-481.035	5				
19-482.035	5				
19-905	8				
19-906	8				
19-910	8				
19-931.0	6				
19-931.2	6				
19-931.4	6				
19-931.5	6				
19-931.6	6				
19-931.8	6				
19-931.9	6				
19-932.2	6				
19-932.4	6				
19-932.5	6				
19-932.6	6				
19-932.7	6				
19-940	6				
19-941	6				
19-948.0	6				
19-949.0	6				
19-951.0	6				
19-951.2	6				
19-951.4	6				
19-951.5	6				
19-951.6	6				
19-951.8	6				
19-951.9	6				
19-952.2	6				
19-952.4	6				
19-952.5	6				
19-952.6	6				
19-952.7	6				

	EAO AG
	Tannwaldstrasse 88 4601 Olten, Switzerland
E-mail	info@eao.com
Website	www.eao.com
	Austria
Phone	+49 201 85 87 0
Fax	+49 201 85 87 210
E-mail	sales.ede@eao.com
	Belgium
Phone	+32 3 777 82 36
Fax	+32 3 777 84 19
E-mail	sales.ebl@eao.com
	China
Phone	+852 27 86 91 41
Fax	+852 27 86 95 61
E-mail	sales.ehk@eao.com
	France
Phone	+33 1 64 43 37 37
Fax	+33 1 64 43 37 49
E-mail	sales.esa@eao.com
	Germany
Phone	+49 201 85 87 0
Fax	+49 201 85 87 210
E-mail	sales.ede@eao.com
	Italy
Phone	+39 035 481 0189
Fax	+39 035 481 3786
E-mail	sales.eit@eao.com
	Japan
Phone	+81 3 5444 5411
Fax	+81 3 5444 0345
E-mail	sales.esj@eao.com
	Netherlands
Phone	+31 78 653 17 00
Fax	+31 78 653 17 99
E-mail	sales.enl@eao.com
	Sweden
Phone	+46 8 683 86 60
Fax	+46 8 724 29 12
E-mail	sales.esw@eao.com
	Switzerland
Phone	+41 62 388 95 00
Fax	+41 62 388 95 55
E-mail	sales.ech@eao.com
	United Kingdom
Phone	+44 1444 236 000
Fax	+44 1444 236 641
E-mail	sales.euk@eao.com
	USA
Phone	+1 203 877 4577
Fax	+1 203 877 3694
E-mail	sales.eus@eao.com
	Other Countries
Phone	+41 62 286 92 10
Fax	+41 62 296 21 62
E-mail	info@eao.com

Компания «Life Electronics» занимается поставками электронных компонентов импортного и отечественного производства от производителей и со складов крупных дистрибьюторов Европы, Америки и Азии.

С конца 2013 года компания активно расширяет линейку поставок компонентов по направлению коаксиальный кабель, кварцевые генераторы и конденсаторы (керамические, пленочные, электролитические), за счёт заключения дистрибьюторских договоров

Мы предлагаем:

- Конкурентоспособные цены и скидки постоянным клиентам.
- Специальные условия для постоянных клиентов.
- Подбор аналогов.
- Поставку компонентов в любых объемах, удовлетворяющих вашим потребностям.
- Приемлемые сроки поставки, возможна ускоренная поставка.
- Доставку товара в любую точку России и стран СНГ.
- Комплексную поставку.
- Работу по проектам и поставку образцов.
- Формирование склада под заказчика.
- Сертификаты соответствия на поставляемую продукцию (по желанию клиента).
- Тестирование поставляемой продукции.
- Поставку компонентов, требующих военную и космическую приемку.
- Входной контроль качества.
- Наличие сертификата ISO.

В составе нашей компании организован Конструкторский отдел, призванный помогать разработчикам, и инженерам.

Конструкторский отдел помогает осуществить:

- Регистрацию проекта у производителя компонентов.
- Техническую поддержку проекта.
- Защиту от снятия компонента с производства.
- Оценку стоимости проекта по компонентам.
- Изготовление тестовой платы монтаж и пусконаладочные работы.



Тел: +7 (812) 336 43 04 (многоканальный)

Email: org@lifeelectronics.ru