

EAO – Your Expert Partner for  
Human Machine Interfaces

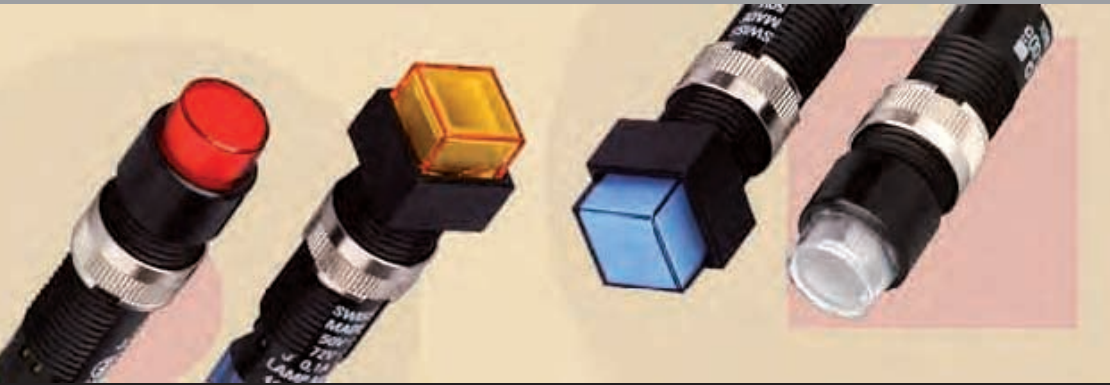

## EAO Product Information

Series 19





---

Description .....	3
Product Assembly .....	4
Devices raised mounting .....	5
Accessories.....	6
Technical Data.....	9
Application guidelines.....	11
Drawings.....	12
Index.....	15

### Product Information

#### General notes

The series contains indicators and illuminated pushbuttons with maintained and momentary action and one contact which may be normally closed or normally open (snap-action element for closing). The illuminated pushbuttons are fitted with snap-action or low-level switching systems.

The front dimensions are 9 x 9 mm or 9 mm dia.

#### Mounting

Mounting from the front through the mounting hole is assured even when the wiring has already been attached.

The units are equipped with soldering/plug-in terminals.

#### Lenses

The flat lenses, made of polycarbonate, are obtainable in various colours. The transparent lens is available with translucent or transparent support.

#### Marking

A limited amount of marking can be provided.

#### Illumination

Perfect illumination of the different coloured lenses is assured by filament lamps Bi-Pin T1 longlife (6 ... 24 V) or LED Bi-Pin T1. LED are available in the colours white, red, yellow, orange and green.

Luminosity and wave length scattering caused by the technology used in the LED manufacturing processes may lead to visual differences in our products.

#### Position indication

The status of a maintained action switch can be determined by the position of the lens.

### Specimen order

#### Indicator :

- Indicator actuator, 9 mm dia., soldering terminal 19-030.005

#### Essential accessories :

- Lens plastic blue, transparent, flush, 9 mm dia. 19-931.6
- Single-LED, T1 Bi-Pin, 3.6 VDC, weiss 10-2603.3179C

*We reserve the right to modify technical data  
All dimensions in mm*

## Indicator, raised mounting

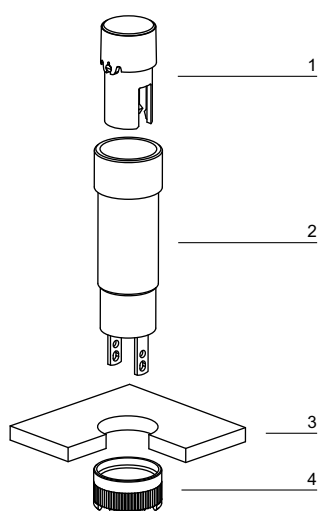

- 1 Lens
- 2 Switch housing
- 3 Front plate
- 4 Fixing nut

## Pushbutton illuminative, raised mounting

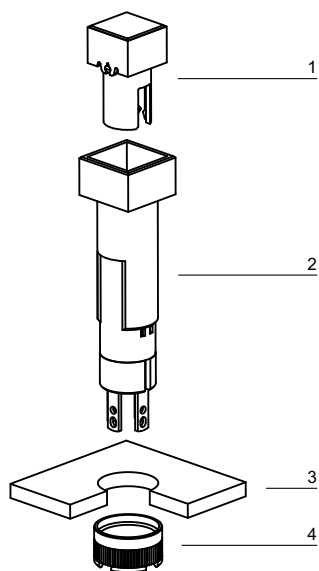



- 1 Lens
- 2 Switch housing
- 3 Front plate
- 4 Fixing nut

## Indicator actuator



### Essential Accessories:

-  Lens page 6
-  Single-LED page 7

	Front protection	Terminals	$\square$ 9 x 9 mm Typ-Nr.	$\varnothing$ 9 mm Typ-Nr.	Component layout	Mounting dimensions	Technical drawing	Circuit drawing	
<b>Indicator actuator</b> Mounting depth : 25 mm	IP 40	S2	<b>19-050.005</b>	<b>19-030.005</b>	1	1	1	1	0.001
Mounting depth : 33 mm	IP 40	S2	<b>19-051.005</b>	<b>19-031.005</b>	1	1	3	1	0.002



Terminals: S2 = Soldering terminal (also pluggable 2.0 x 0.5 mm)

Component layout from page 12, Mounting dimensions from page 12, Technical drawing from page 13, Circuit drawing from page 14

## Illuminated pushbutton actuator



### Essential Accessories:

-  Lens page 6
-  Single-LED page 7

	Front protection	Switching system	Contact material	Contacts	Switching action	Terminals	$\square$ 9 x 9 mm Typ-Nr.	$\varnothing$ 9 mm Typ-Nr.	Component layout	Mounting dimensions	Technical drawing	Circuit drawing	
<b>Illuminated pushbutton actuator</b>	IP 40	LL	Au	1 NC	MA	S2	<b>19-482.035</b>	<b>19-472.035</b>	2	1	2	2	0.002
					M	S2	<b>19-452.035</b>	<b>19-432.035</b>	2	1	2	4	0.002
				1 NO	MA	S2	<b>19-481.035</b>	<b>19-471.035</b>	2	1	2	3	0.002
					M	S2	<b>19-451.035</b>	<b>19-431.035</b>	2	1	2	5	0.002
		SA	Au	1 NO	MA	S2	<b>19-289.035</b>	<b>19-279.035</b>	2	1	2	3	0.002
					M	S2	<b>19-159.035</b>	<b>19-139.035</b>	2	1	2	5	0.002
			Ag	1 NO	MA	S2	<b>19-289.015</b>	<b>19-279.015</b>	2	1	2	3	0.002
					M	S2	<b>19-159.015</b>	<b>19-139.015</b>	2	1	2	5	0.002

Switching system: LL = Low level switching element, SA = Snap-action switching element

Contact material: Au = Gold, Ag = Silver

Contacts: NC = Normally closed, NO = Normally open

Switching action: MA = Maintained action, M = Momentary action

Terminals: S2 = Soldering terminal (also pluggable 2.0 x 0.5 mm)

Component layout from page 12, Mounting dimensions from page 12, Technical drawing from page 13, Circuit drawing from page 14

## Front

### Lens

	Lens	∅ 9 x 9 mm Typ-Nr.	∅ 9 mm Typ-Nr.	
<b>Lens</b> illuminative, holder translucent	Plastic flush transparent blue	<b>19-951.6</b>	<b>19-931.6</b>	0.001
	Plastic flush transparent green	<b>19-951.5</b>	<b>19-931.5</b>	0.001
	Plastic flush transparent red	<b>19-951.2</b>	<b>19-931.2</b>	0.001
	Plastic flush transparent white	<b>19-951.9</b>	<b>19-931.9</b>	0.001
	Plastic flush transparent yellow	<b>19-951.4</b>	<b>19-931.4</b>	0.001
illuminative (not recommended for film insert), holder transparent	Plastic flush transparent blue	<b>19-952.6</b>	<b>19-932.6</b>	0.001
	Plastic flush transparent colourless	<b>19-952.7</b>	<b>19-932.7</b>	0.001
	Plastic flush transparent green	<b>19-952.5</b>	<b>19-932.5</b>	0.001
	Plastic flush transparent red	<b>19-952.2</b>	<b>19-932.2</b>	0.001
	Plastic flush transparent yellow	<b>19-952.4</b>	<b>19-932.4</b>	0.001
non-illuminative	Plastic flush opaque black	<b>19-951.0</b>	<b>19-931.0</b>	0.001
	Plastic flush opaque grey	<b>19-951.8</b>	<b>19-931.8</b>	0.001



### Blind plug

	Blind plug	∅ 9 x 9 mm Typ-Nr.	∅ 9 mm Typ-Nr.	Mounting dimensions	
<b>Blind plug</b>	Plastic black	<b>19-948.0</b>	<b>19-949.0</b>	1	0.001



Mounting dimensions from page 12

## Backside

### PCB plug-in base

	Terminals	Typ-Nr.	Component layout	Technical drawing	
<b>PCB plug-in base</b> Pins axial	P	<b>19-940</b>	3	4	0.001
Pins bent at right-angles	P	<b>19-941</b>	4	5	0.001



Terminals: P = PCB terminal

Component layout from page 12, Technical drawing from page 13



## Flat receptacle

	Typ-Nr.	
<b>Flat receptacle</b> 2.0 x 0.5 mm	<b>31-945</b>	0.001



## Insulation sleeve

	Typ-Nr.	
<b>Insulation sleeve</b> for Flat receptacle 31-945	<b>31-928</b>	0.001



## Illumination

### Filament lamp

	Socket	Operating voltage/-current	Typ-Nr.	
<b>Filament lamp</b> max. PIN length 5 mm	T1 Bi-Pin	12 VAC/DC, 25 mA	<b>10-1609.1199</b>	0.001
		24 VAC/DC, 20 mA	<b>10-1612.1179</b>	0.001
		6 VAC/DC, 70 mA	<b>10-1606.1309</b>	0.001



### Single-LED

	Socket	Light colour	Operating voltage/-current	Typ-Nr.	
<b>Single-LED</b> max. PIN length 8 mm	T1 Bi-Pin	green	2.2 VDC, 20 mA	<b>10-2602.3175C</b>	0.001
		red	2.2 VDC, 20 mA	<b>10-2602.3172C</b>	0.001
		white	3.6 VDC, 20 mA	<b>10-2603.3179C</b>	0.001
		yellow	2.2 VDC, 20 mA	<b>10-2602.3174C</b>	0.001



### Multi-LED

	Socket	Light colour	Operating voltage/-current	Typ-Nr.	
<b>Multi-LED</b> max. PIN length 5 mm	T1 Bi-Pin	green	28 VDC, 12 mA	<b>10-4613.3105B</b>	0.001
		orange	28 VDC, 12 mA	<b>10-4613.3103B</b>	0.001
		red	28 VDC, 12 mA	<b>10-4613.3102B</b>	0.001
		yellow	28 VDC, 12 mA	<b>10-4613.3104B</b>	0.001



## Assembling

### Fixing nut

	Typ-Nr.	 kg
<b>Fixing nut</b> Ø 9/M8 x 13 mm	<b>19-991</b>	0.001



### Dressing tool

	Typ-Nr.	 kg
<b>Dressing tool</b> for aligning buttons	<b>19-906</b>	0.011



### Lens remover

	Typ-Nr.	 kg
<b>Lens remover</b>	<b>19-910</b>	0.002



### Lamp remover

	Typ-Nr.	 kg
<b>Lamp remover</b>	<b>11-906</b>	0.003



CAUTION  
A switching process might be released when replacing the Lamp/LED !

### Mounting tool

	Typ-Nr.	 kg
<b>Mounting tool</b> for Fixing nut long 19-991	<b>19-905</b>	0.011



## Actuator with snap-action switching element

### Switching system

Single-break, snap-action switching system.  
1 normally open contact

### Material

#### Material of contact

Gold plated Silver, Silver plated

#### Switch housing

Polyetherimide (PEI), self-extinguishing

#### Actuator housing

Polyphenyleneoxide (PPO), self-extinguishing, colour black

### Mechanical characteristics

#### Terminals

Universal terminal:  
Max. wire diameter 2 x 0.8 mm  
Max. wire cross-section of stranded cable 1 x 0.75 mm<sup>2</sup>

Plug-in terminal: 2.0 x 0.5 mm  
For these terminals we can also supply a plug-in base which, when soldered on to the board, enables the switch to be plugged in.

#### Tightening torque

for fixing nut max. 20 Ncm

#### Actuating force

1.6 N

#### Actuating travel

2.8 mm ±0.2 mm

#### Mechanical lifetime

2 million operations

### Electrical characteristics

#### Switch rating

Silver plated:  
Max. 50 VAC / 72 VDC, 0.8 A or 50 W  
Min. 20 V, 10 mA  
Gold plated:  
Max. 50 VAC / 72 VDC, 100 mA or 5 W  
Min. 100 µV, 50 µA

#### Electric strength

2500 VAC, 50 Hz, 1 min. between all terminals and earth, as per IEC 60512-2-11

### Environmental conditions

#### Storage temperature

-40 °C ... +85 °C

#### Service temperature

without illumination -25 °C ... +65 °C  
with incandescent lamp -25 °C ... +45 °C  
with LED -25 °C ... +65 °C  
for indicators and illuminated pushbuttons mounted as a block, make sure the heat can escape freely

#### Protection degree

IP 40 front side, as per IEC 60529

## Actuator with low level switching element

### Switching system

This low-level switching system was designed for switching low powers in electronic circuits. The switching system assures reliable switching of loads.  
Single-break momentary contact, as normally open or normally closed with 4 independent points of contact.  
Special features are the long life, extremely short rebound time and stable contact resistance.  
1 normally open or 1 normally closed contact.

### Material

#### Material of contact

Gold plated

#### Actuator housing

Polyphenyleneoxide (PPO), self-extinguishing, colour black

### Mechanical characteristics

#### Terminals

Universal terminal:  
Max. wire diameter 2 x 0.8 mm  
Max. wire cross-section of stranded cable 1 x 0.75 mm<sup>2</sup>

Plug-in terminal: 2.0 x 0.5 mm  
For these terminals we can also supply a plug-in base which, when soldered on to the board, enables the switch to be plugged in.

#### Tightening torque

for fixing nut max. 20 Ncm

#### Actuating force

1.8 N ±0.3 N

#### Actuating travel

2.8 mm ±0.2 mm

#### Rebound time

Typ. <100 µs

#### Mechanical lifetime

5 million operations

### Electrical characteristics

#### Contact resistance

≤50 mΩ starting value (initial) as per IEC 60512-2-2b

#### Switch rating

10 µA, 100 µV to 100 mA at 42 VAC/VDC

#### Electric strength

2500 VAC, 50 Hz, 1 min. between all terminals and earth, as per IEC 60512-2-11

### Environmental conditions

#### Storage temperature

-40 °C ... +85 °C

#### Service temperature

without illumination -25 °C ... +65 °C  
with incandescent lamp -25 °C ... +45 °C  
with LED -25 °C ... +65 °C

for indicators and illuminated pushbuttons mounted as a block,  
make sure the heat can escape freely

**Protection degree**

IP 40 front side, as per IEC 60529

**Shock resistance**

(Single impacts, semi-sinusoidal)

15 g for 11 ms, as per IEC 60512-4-3, IEC 60068-2-27

## Suppressor circuits

When switching inductive loads such as relays, DC motors, and DC solenoids, it is always important to absorb surges (e.g. with a diode) to protect the contacts. When these inductive loads are switched off, a counter emf can severely damage switch contacts and greatly shorten lifetime.

Fig. 1 shows an inductive load with a free-wheeling diode connected in parallel. This free-wheeling diode provides a path for the inductor current to flow when the current is interrupted by the switch. Without this free-wheeling diode, the voltage across the coil will be limited only by dielectric breakdown voltages of the circuit or parasitic elements of the coil. This voltage can be kilovolts in amplitude even when nominal circuit voltages are low (e.g. 12 VDC) see Fig. 2.

The free-wheeling diode should be chosen so that the reverse breakdown voltage is greater than the voltage driving the inductive load. The DC blocking voltage ( $V_R$ ) of the free-wheeling diode can be found in the datasheet of a diode. The forward current should be equal or greater than the maximum current flowing through the load.

**To get an efficient protection, the free-wheeling diode must be connected as close as possible to the inductive load!**

Switching with inductive load  
Fig. 1

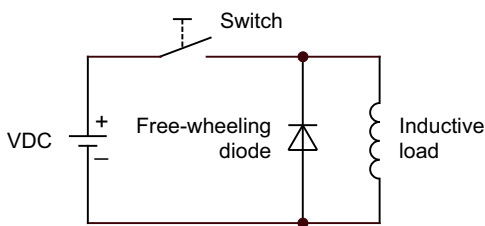

Counter emf  
over load without free-wheeling diode  
Fig. 2

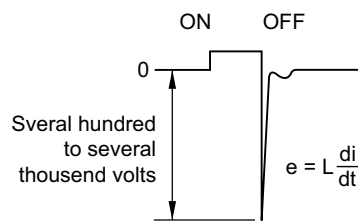

## Component layout

### 1 Indicator actuator page 5

9 x 9 mm      Ø9 mm



### 2 Illuminated pushbutton actuator page 5

9 x 9 mm      Ø9 mm

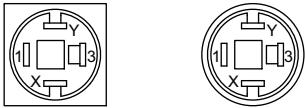

### 3 PCB plug-in base page 6

Drilling plan (element side)  
Through-connection recommended

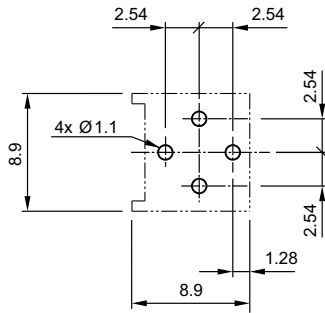

### 4 PCB plug-in base page 6

Drilling plan (element side)  
Through-connection recommended

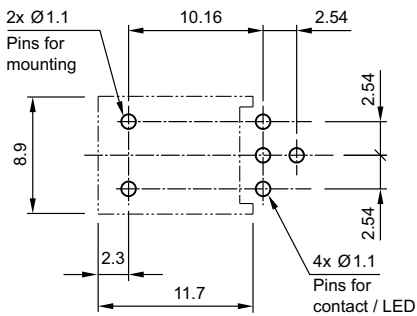

## Mounting dimensions

### 1 Indicator actuator page 5 | Illuminated pushbutton actuator page 5 | Blind plug page 6

9 x 9 mm      Ø9 mm

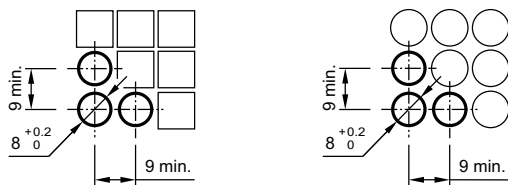

## Technical drawing

1 Indicator actuator page 5

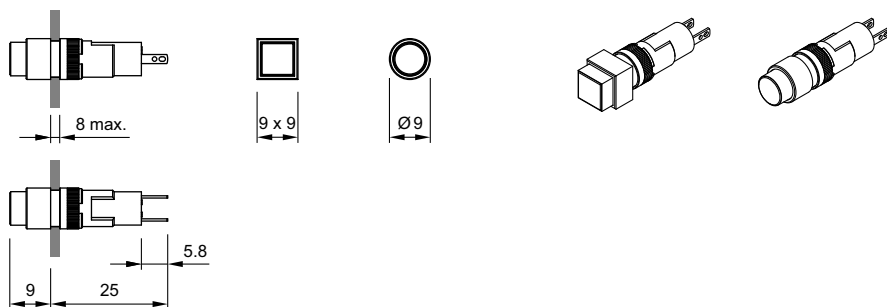

2 Illuminated pushbutton actuator page 5

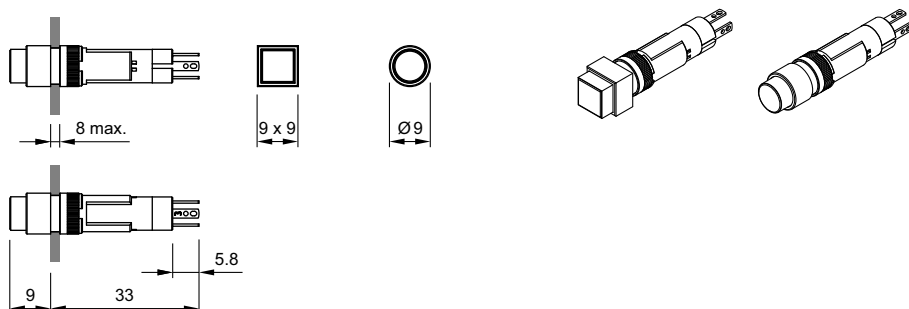

3 Indicator actuator page 5

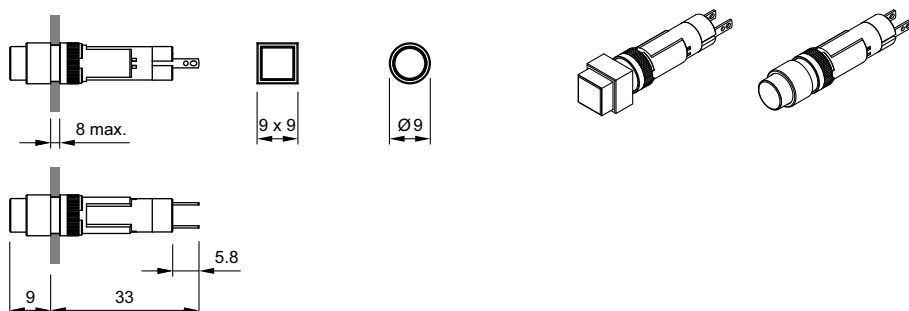

4 PCB plug-in base page 6

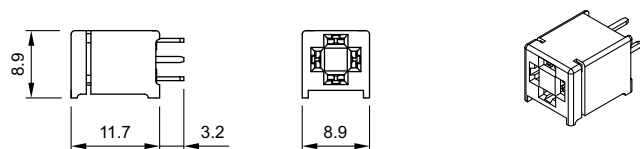

5 PCB plug-in base page 6

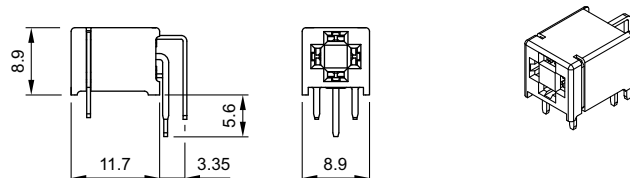

## Circuit drawing

1 Indicator actuator page 5



2 Illuminated pushbutton actuator page 5

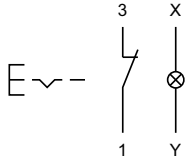

3 Illuminated pushbutton actuator page 5

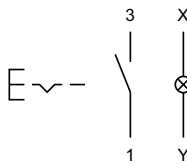

4 Illuminated pushbutton actuator page 5

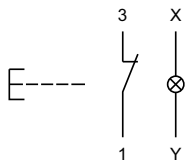

5 Illuminated pushbutton actuator page 5

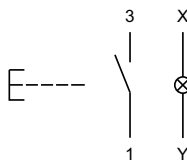



# Index from Typ-Nr.

Typ-Nr.	Page	Typ-Nr.	Page	Typ-Nr.	Page
10-1606.1309	7	19-991	8		
10-1609.1199	7	31-928	7		
10-1612.1179	7	31-945	7		
10-2602.3172C	7				
10-2602.3174C	7				
10-2602.3175C	7				
10-2603.3179C	7				
10-4613.3102B	7				
10-4613.3103B	7				
10-4613.3104B	7				
10-4613.3105B	7				
11-906	8				
19-030.005	5				
19-031.005	5				
19-050.005	5				
19-051.005	5				
19-139.015	5				
19-139.035	5				
19-159.015	5				
19-159.035	5				
19-279.015	5				
19-279.035	5				
19-289.015	5				
19-289.035	5				
19-431.035	5				
19-432.035	5				
19-451.035	5				
19-452.035	5				
19-471.035	5				
19-472.035	5				
19-481.035	5				
19-482.035	5				
19-905	8				
19-906	8				
19-910	8				
19-931.0	6				
19-931.2	6				
19-931.4	6				
19-931.5	6				
19-931.6	6				
19-931.8	6				
19-931.9	6				
19-932.2	6				
19-932.4	6				
19-932.5	6				
19-932.6	6				
19-932.7	6				
19-940	6				
19-941	6				
19-948.0	6				
19-949.0	6				
19-951.0	6				
19-951.2	6				
19-951.4	6				
19-951.5	6				
19-951.6	6				
19-951.8	6				
19-951.9	6				
19-952.2	6				
19-952.4	6				
19-952.5	6				
19-952.6	6				
19-952.7	6				

	<b>EAO AG</b>
	Tannwaldstrasse 88 4601 Olten, Switzerland
<b>E-mail</b>	info@eao.com
<b>Website</b>	www.eao.com
	<b>Austria</b>
Phone	+49 201 85 87 0
Fax	+49 201 85 87 210
E-mail	sales.ede@eao.com
	<b>Belgium</b>
Phone	+32 3 777 82 36
Fax	+32 3 777 84 19
E-mail	sales.ebl@eao.com
	<b>China</b>
Phone	+852 27 86 91 41
Fax	+852 27 86 95 61
E-mail	sales.ehk@eao.com
	<b>France</b>
Phone	+33 1 64 43 37 37
Fax	+33 1 64 43 37 49
E-mail	sales.esa@eao.com
	<b>Germany</b>
Phone	+49 201 85 87 0
Fax	+49 201 85 87 210
E-mail	sales.ede@eao.com
	<b>Italy</b>
Phone	+39 035 481 0189
Fax	+39 035 481 3786
E-mail	sales.eit@eao.com
	<b>Japan</b>
Phone	+81 3 5444 5411
Fax	+81 3 5444 0345
E-mail	sales.esj@eao.com
	<b>Netherlands</b>
Phone	+31 78 653 17 00
Fax	+31 78 653 17 99
E-mail	sales.enl@eao.com
	<b>Sweden</b>
Phone	+46 8 683 86 60
Fax	+46 8 724 29 12
E-mail	sales.esw@eao.com
	<b>Switzerland</b>
Phone	+41 62 388 95 00
Fax	+41 62 388 95 55
E-mail	sales.ech@eao.com
	<b>United Kingdom</b>
Phone	+44 1444 236 000
Fax	+44 1444 236 641
E-mail	sales.euk@eao.com
	<b>USA</b>
Phone	+1 203 877 4577
Fax	+1 203 877 3694
E-mail	sales.eus@eao.com
	<b>Other Countries</b>
Phone	+41 62 286 92 10
Fax	+41 62 296 21 62
E-mail	info@eao.com

Компания «Life Electronics» занимается поставками электронных компонентов импортного и отечественного производства от производителей и со складов крупных дистрибьюторов Европы, Америки и Азии.

С конца 2013 года компания активно расширяет линейку поставок компонентов по направлению коаксиальный кабель, кварцевые генераторы и конденсаторы (керамические, пленочные, электролитические), за счёт заключения дистрибьюторских договоров

Мы предлагаем:

- Конкурентоспособные цены и скидки постоянным клиентам.
- Специальные условия для постоянных клиентов.
- Подбор аналогов.
- Поставку компонентов в любых объемах, удовлетворяющих вашим потребностям.
- Приемлемые сроки поставки, возможна ускоренная поставка.
- Доставку товара в любую точку России и стран СНГ.
- Комплексную поставку.
- Работу по проектам и поставку образцов.
- Формирование склада под заказчика.
- Сертификаты соответствия на поставляемую продукцию (по желанию клиента).
- Тестирование поставляемой продукции.
- Поставку компонентов, требующих военную и космическую приемку.
- Входной контроль качества.
- Наличие сертификата ISO.

В составе нашей компании организован Конструкторский отдел, призванный помогать разработчикам, и инженерам.

Конструкторский отдел помогает осуществить:

- Регистрацию проекта у производителя компонентов.
- Техническую поддержку проекта.
- Защиту от снятия компонента с производства.
- Оценку стоимости проекта по компонентам.
- Изготовление тестовой платы монтаж и пусконаладочные работы.



Тел: +7 (812) 336 43 04 (многоканальный)

Email: [org@lifeelectronics.ru](mailto:org@lifeelectronics.ru)