

856966

358.4 MHz SAW Filter

Applications

- For WCDMA/LTE applications

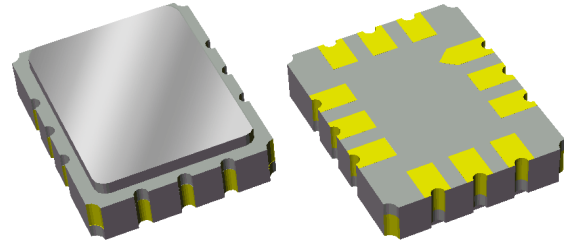

Product Features

- Usable bandwidth 24.8 MHz
- Low loss
- High attenuation
- Low EVM
- Balanced operation
- Ceramic Surface Mount Package (SMP)
- Small Size: 7.01 x 5.51 x 1.63 mm
- Hermetic **RoHS** compliant, **Pb-free**

General Description

The 856966 is a high-performance IF SAW filter with a center frequency of 358.4MHz and a 1 dB bandwidth of 24.8 MHz.

It features low loss with excellent attenuation, and is designed to be used with a balanced input and output. The small size of this surface mounted filter makes it an economical choice for demanding applications such as WCDMA/LTE or other similar high data rate communications standards.

This device is RoHS compliant and Pb-free.

Functional Block Diagram

Top view

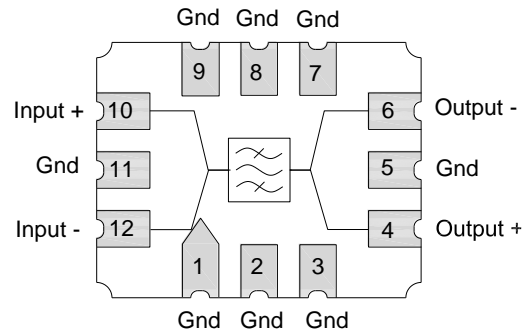

Pin Configuration

Pin #	Bal/Bal	Description
10		Input +
12		Input -
4		Output +
6		Output -
1,2,3,5		Ground
7,8,9,11		Ground

Ordering Information

Part No.	Description
856966	packaged part
856966-EVB	evaluation board

Standard T/R size = 3000 units/reel.

Specifications

Electrical Specifications (1, 2)

 Specified Temperature Range: ⁽³⁾ -15 to +85 °C

Parameter ⁽⁴⁾	Conditions	Min	Typical ⁽⁵⁾	Max	Units
Center Frequency		-	358.4	-	MHz
Insertion Loss	at 358.4 MHz	-	9.0	11.0	dB
Amplitude Variation ⁽⁶⁾	346.0 – 370.8 MHz	-	0.31	1.0	dB p-p
Absolute Group Delay	346.0 – 370.8 MHz	-	0.45	0.6	μs
Group Delay Variation ⁽⁶⁾	346.0 – 370.8 MHz	-	25	100	ns p-p
EVM ⁽⁷⁾	346.0 – 370.8 MHz	-	1.2	3	%
Time side-lobe response attenuation ⁽⁸⁾	(1.2 – 500 μs)	40	60	-	dB
Input Return Loss	346.0 – 370.8 MHz	10	12.4	-	dB
Output Return Loss	346.0 – 370.8 MHz	10	12.5	-	dB
Rejection/Attenuation ⁽⁹⁾					
10 – 258.4 MHz		55	71	-	dB
258.4 – 309.9 MHz (F ₀ - 100 to F ₀ - 48.5 MHz)		55	59	-	dB
309.9 – 325.4 MHz (F ₀ - 48.5 to F ₀ - 33 MHz)		35	50	-	dB
325.4 – 335.8 MHz (F ₀ - 33 to F ₀ - 22.6 MHz)		30	35	-	dB
335.8 – 336.4 MHz (F ₀ - 22.6 to F ₀ - 22.0 MHz)		25	37	-	dB
336.4 – 336.9 MHz (F ₀ - 22.0 to F ₀ - 21.5 MHz)		20	37	-	dB
336.9 – 337.2 MHz (F ₀ - 21.5 to F ₀ - 21.2 MHz)		15	37	-	dB
337.2 – 337.6 MHz (F ₀ - 21.2 to F ₀ - 20.8 MHz)		10	35	-	dB
337.6 – 338.4 MHz (F ₀ - 20.8 to F ₀ - 20 MHz)		5	24	-	dB
378.4 – 379.2 MHz (F ₀ + 20 to F ₀ + 20.8 MHz)		5	25	-	dB
379.2 – 379.6 MHz (F ₀ + 20.8 to F ₀ + 21.2 MHz)		10	32	-	dB
379.6 – 379.9 MHz (F ₀ + 21.2 to F ₀ + 21.5 MHz)		15	35	-	dB
379.9 – 380.4 MHz (F ₀ + 21.5 to F ₀ + 22.0 MHz)		20	35	-	dB
380.4 – 381.0 MHz (F ₀ + 22.0 to F ₀ + 22.6 MHz)		25	36	-	dB
381.0 – 391.4 MHz (F ₀ + 22.6 to F ₀ + 33 MHz)		30	36	-	dB
391.4 – 406.9 MHz (F ₀ + 33 to F ₀ + 48.5 MHz)		35	53	-	dB
406.9 – 458.4 MHz (F ₀ + 48.5 to F ₀ + 100 MHz)		55	59	-	dB
458.4 – 525.0 MHz (F ₀ + 100 to 525 MHz)		55	70	-	dB
525.0 – 560.0 MHz		65	76	-	dB
560.0 – 675.0 MHz		55	65	-	dB
675.0 – 750.0 MHz		52	56	-	dB
750.0 – 1000 MHz		55	70	-	dB
Source Impedance (balanced) ⁽¹⁰⁾		-	200	-	Ω
Load Impedance (balanced) ⁽¹⁰⁾		-	200 or 50	-	Ω

Notes:

- All specifications are based on the TriQuint schematic for the main reference design shown on page 3
- An external impedance matching network with ±2% tolerance will be necessary to achieve the proposed specifications
- In production, devices will be tested at room temperature to a guardbanded specification to ensure electrical compliance over temperature
- Electrical margin has been built into the design to account for the variations due to temperature drift and manufacturing tolerances
- Typical values are based on average measurements at room temperature
- These Variations are defined as the difference between the lowest loss and the highest loss within the defined frequency points
- Measured with a RRC filtered QPSK modulated signal with a BW of 3.84 MHz placed anywhere within the defined frequency points
- Excluding the triple transit peak at 1.35 μs that may reach 38 dB.
- Relative to insertion loss at center frequency
- This is the optimum impedance in order to achieve the performance shown

Reference Design – 200Ω Bal Input, 200Ω Bal Output

Schematic

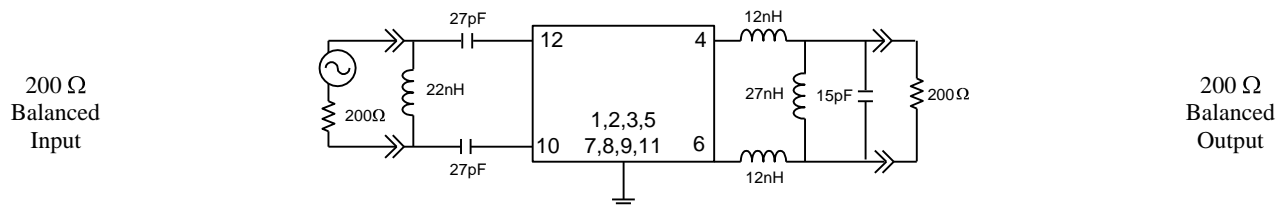

Notes:

1. Actual matching values may vary due to PCB layout and parasitic

PC Board

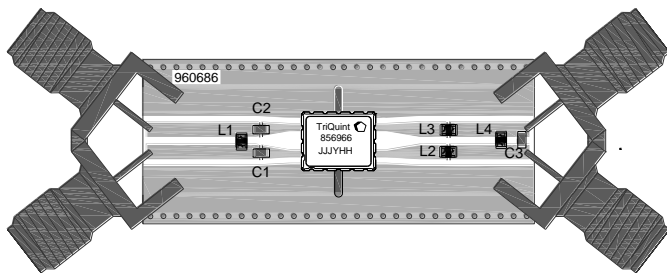

Notes:

- Top, middle & bottom layers: 1 oz copper
- Substrates: FR4 dielectric, .031" thick
- Finish plating: Nickel: 3-8μm thick, Gold: .03-.2μm thick
- Hole plating: Copper min .0008μm thick

Mounting Configuration

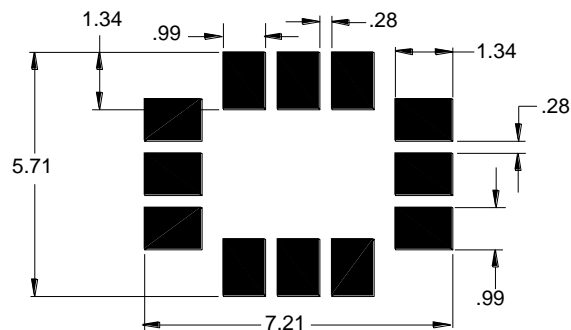

Notes:

1. All dimensions are in millimeters.
2. This footprint represents a recommendation only.

Bill of Material

Reference Desg.	Value	Description	Manufacturer	Part Number
L1	22 nH	Coil Wire-wound, 0805, 5%	Coilcraft	0805CS-220XJLC
L2	12nH	Coil Wire-wound, 0805, 5%	Coilcraft	0805CS-120XJLC
L3	12 nH	Coil Wire-wound, 0805, 5%	Coilcraft	0805CS-120XJLC
L4	27nH	Coil Wire-wound, 0805, 5%	Coilcraft	0805CS-270XJLC
C1	27 pF	Chip Ceramic, 0805, 5%	MuRata	GRM40COG270J050BL
C2	27 pF	Chip Ceramic, 0805, 5%	MuRata	GRM40COG270J050BL
C3	15 pF	Chip Ceramic, 0805, 5%	MuRata	GRM40COG150J050BL
SMA	N/A	SMA connector	Johnson Components	142-0701-801
PCB	N/A	3-layer	multiple	960686

Typical Performance (at room temperature)

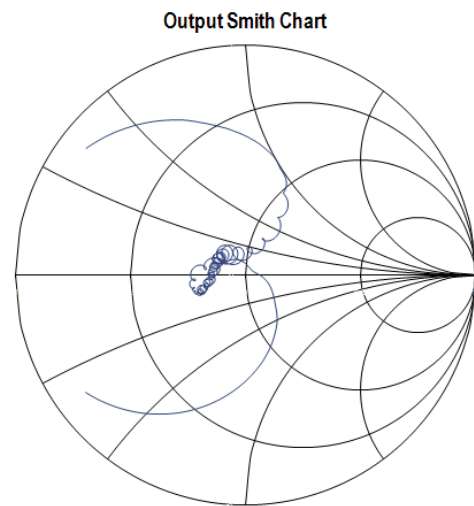
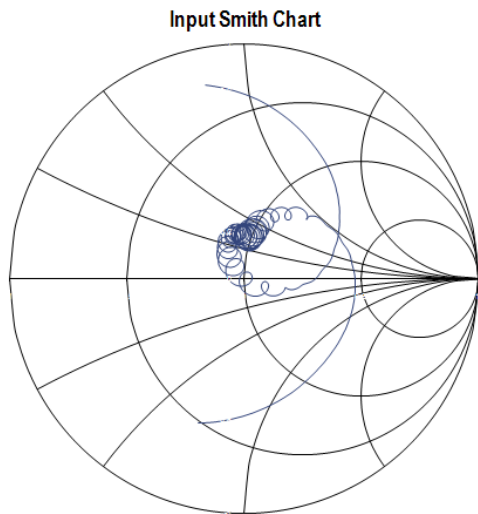
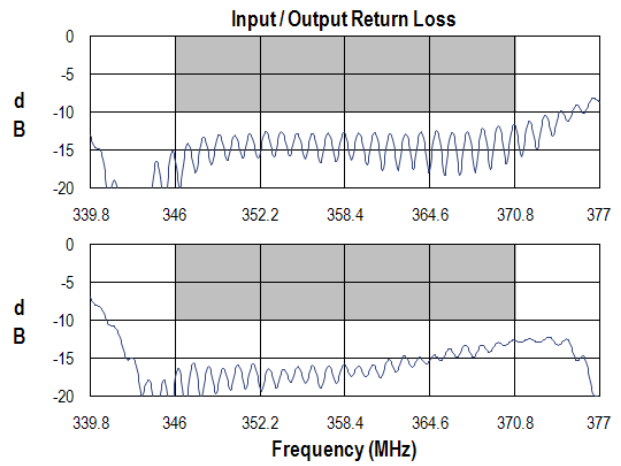
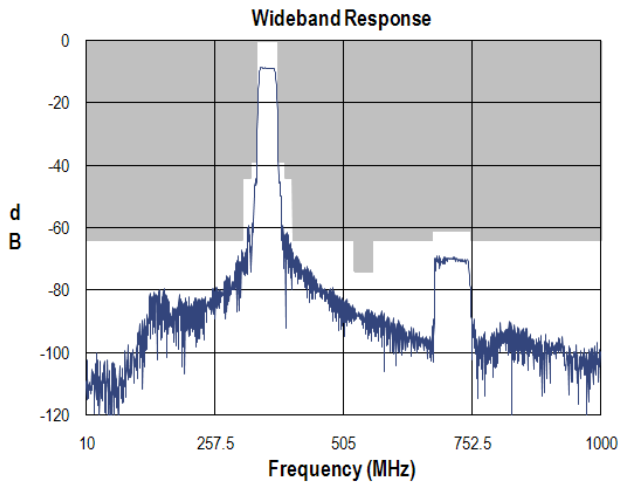
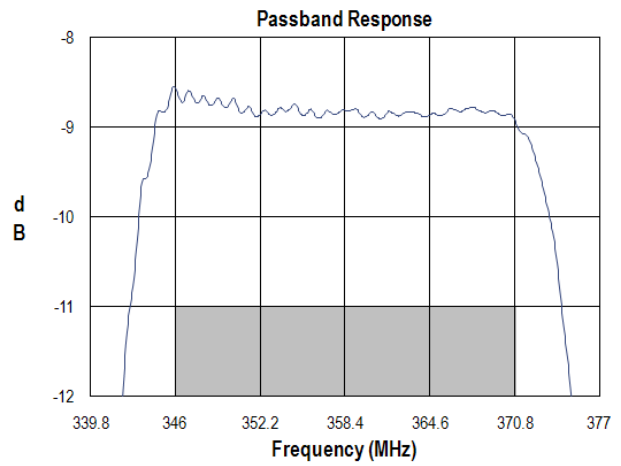
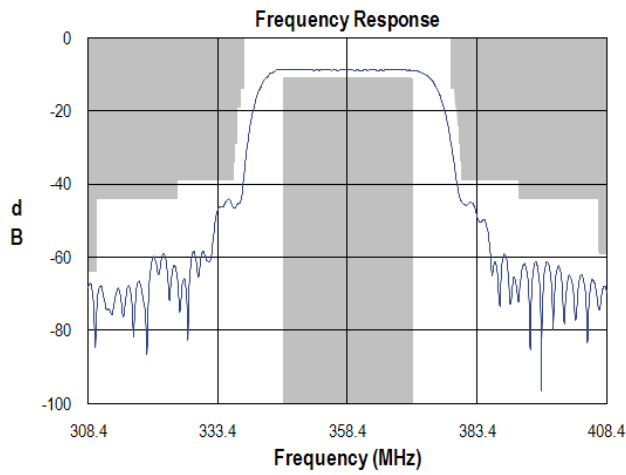

856966

358.4 MHz SAW Filter

Mechanical Information

Package Information, Dimensions and Marking

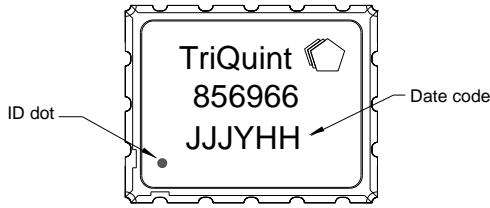

Package Style: SMP-28B
 Dimensions: 7.01 x 5.51 x 1.63 mm

Body: Al_2O_3 ceramic
 Lid: Kovar, Ni plated
 Terminations: Au plating 0.5 - 1.0 μ m, over a 2-6 μ m Ni plating

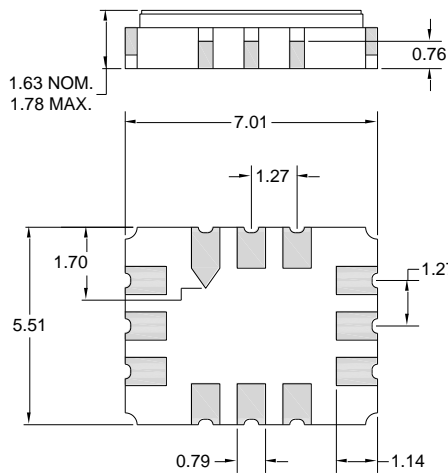

All dimensions shown are nominal in millimeters
 All tolerances are ± 0.15 mm except overall length and width ± 0.10 mm

The date code consists of: day of the current year (Julian, 3 digits), Y = last digit of the year (1 digit), and HH = hour (2 digits)

Tape and Reel Information

Standard T/R size = 3000 units/reel. All dimensions are in millimeters

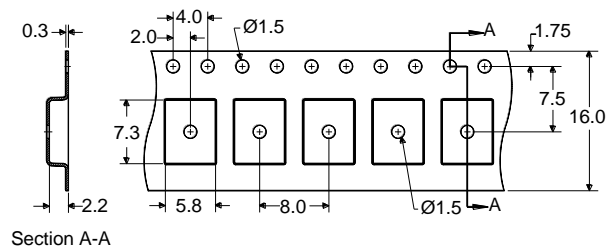
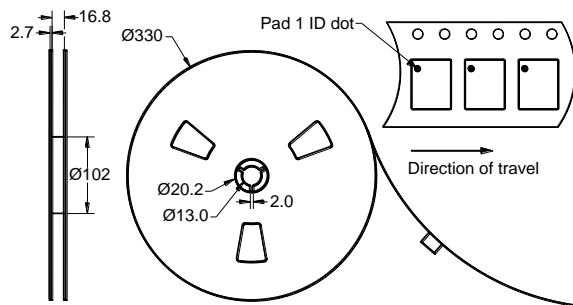

Absolute Maximum Ratings

Parameter	Rating
Operating Temperature	-15 to +85 °C
Storage Temperature	-40 to +85 °C
Input Power	+19 dBm, 24 hours at 50°C, in band; +25 dBm, 24 hours at 50°C, out of band

Operation of this device outside the parameter ranges given above may cause permanent damage.

Product Compliance Information

ESD Information



Caution! ESD-Sensitive Device

ESD Rating: 0

Value: Passes ≥ 200 V min.
 Test: Human Body Model (HBM)
 Standard: JEDEC Standard JESD22-A114

ESD Rating: A

Value: Passes ≥ 150 V min.
 Test: Machine Model (MM)
 Standard: JEDEC Standard JESD22-A115

MSL Rating

Devices are Hermetic, therefore MSL is not applicable

Solderability

Compatible with the latest version of J-STD-020, lead free solder, 260°C

Refer to **Soldering Profile** for recommended guidelines.

This part is compliant with EU 2002/95/EC RoHS directive (Restrictions on the Use of Certain Hazardous Substances in Electrical and Electronic Equipment).

This product also has the following attributes:

- Halogen Free (Chlorine, Bromine)
- Antimony Free
- TBBP-A (C₁₅H₁₂Br₄O₂) Free
- PFOS Free
- SVHC Free

Contact Information

For the latest specifications, additional product information, worldwide sales and distribution locations, and information about TriQuint:

Web: www.triquint.com Tel: +1.407.886.8860
 Email: info-sales@tqs.com Fax: +1.407.886.7061

For technical questions and application information:

Email: flapplication.engineering@tqs.com

Important Notice

The information contained herein is believed to be reliable. TriQuint makes no warranties regarding the information contained herein. TriQuint assumes no responsibility or liability whatsoever for any of the information contained herein. TriQuint assumes no responsibility or liability whatsoever for the use of the information contained herein. The information contained herein is provided "AS IS, WHERE IS" and with all faults, and the entire risk associated with such information is entirely with the user. All information contained herein is subject to change without notice. Customers should obtain and verify the latest relevant information before placing orders for TriQuint products. The information contained herein or any use of such information does not grant, explicitly or implicitly, to any party any patent rights, licenses, or any other intellectual property rights, whether with regard to such information itself or anything described by such information.

TriQuint products are not warranted or authorized for use as critical components in medical, life-saving, or life-sustaining applications, or other applications where a failure would reasonably be expected to cause severe personal injury or death.

Компания «Life Electronics» занимается поставками электронных компонентов импортного и отечественного производства от производителей и со складов крупных дистрибьюторов Европы, Америки и Азии.

С конца 2013 года компания активно расширяет линейку поставок компонентов по направлению коаксиальный кабель, кварцевые генераторы и конденсаторы (керамические, пленочные, электролитические), за счёт заключения дистрибьюторских договоров

Мы предлагаем:

- Конкурентоспособные цены и скидки постоянным клиентам.
- Специальные условия для постоянных клиентов.
- Подбор аналогов.
- Поставку компонентов в любых объемах, удовлетворяющих вашим потребностям.
- Приемлемые сроки поставки, возможна ускоренная поставка.
- Доставку товара в любую точку России и стран СНГ.
- Комплексную поставку.
- Работу по проектам и поставку образцов.
- Формирование склада под заказчика.
- Сертификаты соответствия на поставляемую продукцию (по желанию клиента).
- Тестирование поставляемой продукции.
- Поставку компонентов, требующих военную и космическую приемку.
- Входной контроль качества.
- Наличие сертификата ISO.

В составе нашей компании организован Конструкторский отдел, призванный помогать разработчикам, и инженерам.

Конструкторский отдел помогает осуществить:

- Регистрацию проекта у производителя компонентов.
- Техническую поддержку проекта.
- Защиту от снятия компонента с производства.
- Оценку стоимости проекта по компонентам.
- Изготовление тестовой платы монтаж и пусконаладочные работы.



Тел: +7 (812) 336 43 04 (многоканальный)

Email: org@lifeelectronics.ru