

NSS1C300ET4G

100 V, 3.0 A, Low $V_{CE(sat)}$ PNP Transistor

ON Semiconductor's e²PowerEdge family of low $V_{CE(sat)}$ transistors are surface mount devices featuring ultra low saturation voltage ($V_{CE(sat)}$) and high current gain capability. These are designed for use in low voltage, high speed switching applications where affordable efficient energy control is important.

Typical applications are DC–DC converters and power management in portable and battery powered products such as cellular and cordless phones, PDAs, computers, printers, digital cameras and MP3 players. Other applications are low voltage motor controls in mass storage products such as disc drives and tape drives. In the automotive industry they can be used in air bag deployment and in the instrument cluster. The high current gain allows e²PowerEdge devices to be driven directly from PMU's control outputs, and the Linear Gain (Beta) makes them ideal components in analog amplifiers.

Features

- Complement to NSS1C301ET4G
- NSV Prefix for Automotive and Other Applications Requiring Unique Site and Control Change Requirements; AEC–Q101 Qualified and PPAP Capable
- These Devices are Pb–Free and are RoHS Compliant

MAXIMUM RATINGS ($T_A = 25^\circ\text{C}$)

Rating	Symbol	Max	Unit
Collector–Base Voltage	V_{CBO}	140	Vdc
Collector–Emitter Voltage	V_{CEO}	100	Vdc
Emitter–Base Voltage	V_{EB}	6.0	Vdc
Collector Current – Continuous	I_C	3.0	Adc
Collector Current – Peak	I_{CM}	6.0	Adc
Base Current	I_B	0.5	Adc
Total Power Dissipation @ $T_C = 25^\circ\text{C}$ Derate above 25°C	P_D	33 0.26	W W/ $^\circ\text{C}$
Total Power Dissipation (Note 1) @ $T_A = 25^\circ\text{C}$ Derate above 25°C	P_D	2.1 0.017	W W/ $^\circ\text{C}$
Operating and Storage Junction Temperature Range	T_J, T_{stg}	–65 to +150	$^\circ\text{C}$

Stresses exceeding those listed in the Maximum Ratings table may damage the device. If any of these limits are exceeded, device functionality should not be assumed, damage may occur and reliability may be affected.

1. These ratings are applicable when surface mounted on the minimum pad sizes recommended.



ON Semiconductor®

www.onsemi.com

100 VOLTS, 3.0 AMPS PNP LOW $V_{CE(sat)}$ TRANSISTOR

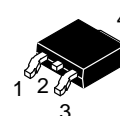
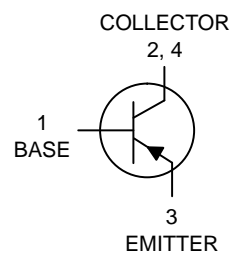

DPAK
CASE 369C
STYLE 1

MARKING DIAGRAM

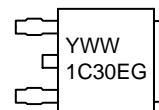

Y = Year
WW = Work Week
1C30E = Device Code
G = Pb–Free

ORDERING INFORMATION

Device	Package	Shipping†
NSS1C300ET4G	DPAK (Pb–Free)	2500/ Tape & Reel
NSV1C300ET4G	DPAK (Pb–Free)	2500/ Tape & Reel

†For information on tape and reel specifications, including part orientation and tape sizes, please refer to our Tape and Reel Packaging Specification Brochure, BRD8011/D.

NSS1C300ET4G

THERMAL CHARACTERISTICS

Characteristic	Symbol	Max	Unit
Thermal Resistance, Junction-to-Case	$R_{\theta JC}$	3.8	$^{\circ}\text{C}/\text{W}$
Thermal Resistance, Junction-to-Ambient (Note 2)	$R_{\theta JA}$	59.5	$^{\circ}\text{C}/\text{W}$

2. These ratings are applicable when surface mounted on the minimum pad sizes recommended.

ELECTRICAL CHARACTERISTICS ($T_A = 25^{\circ}\text{C}$ unless otherwise noted)

Characteristic	Symbol	Min	Typ	Max	Unit
----------------	--------	-----	-----	-----	------

OFF CHARACTERISTICS

Collector-Emmitter Breakdown Voltage ($I_C = -10 \text{ mAdc}$, $I_B = 0$)	$V_{(BR)CEO}$	-100	-	-	Vdc
Collector-Base Breakdown Voltage ($I_C = -0.1 \text{ mAdc}$, $I_E = 0$)	$V_{(BR)CBO}$	-140	-	-	Vdc
Emitter-Base Breakdown Voltage ($I_E = -0.1 \text{ mAdc}$, $I_C = 0$)	$V_{(BR)EBO}$	-6.0	-	-	Vdc
Collector Cutoff Current ($V_{CB} = -140 \text{ Vdc}$, $I_E = 0$)	I_{CBO}	-	-	-0.1	μAdc
Emitter Cutoff Current ($V_{EB} = -6.0 \text{ Vdc}$)	I_{EBO}	-	-	-0.1	μAdc

ON CHARACTERISTICS

DC Current Gain (Note 3) ($I_C = -0.1 \text{ A}$, $V_{CE} = -2.0 \text{ V}$) ($I_C = -0.5 \text{ A}$, $V_{CE} = -2.0 \text{ V}$) ($I_C = -1.0 \text{ A}$, $V_{CE} = -2.0 \text{ V}$) ($I_C = -3.0 \text{ A}$, $V_{CE} = -2.0 \text{ V}$)	h_{FE}	180 180 120 50	- - - -	- - 360 -	-
Collector-Emmitter Saturation Voltage (Note 3) ($I_C = -0.1 \text{ A}$, $I_B = -10 \text{ mA}$) ($I_C = -1.0 \text{ A}$, $I_B = -0.100 \text{ A}$) ($I_C = -2.0 \text{ A}$, $I_B = -0.200 \text{ A}$) ($I_C = -3.0 \text{ A}$, $I_B = -0.300 \text{ A}$)	$V_{CE(sat)}$	- - - -	- - - -	-0.070 -0.150 -0.250 -0.400	V
Base-Emmitter Saturation Voltage (Note 3) ($I_C = -1.0 \text{ A}$, $I_B = -0.1 \text{ A}$)	$V_{BE(sat)}$	-	-	-1.0	V
Base-Emmitter Turn-on Voltage (Note 3) ($I_C = -1.0 \text{ A}$, $V_{CE} = -2.0 \text{ V}$)	$V_{BE(on)}$	-	-	-0.900	V
Cutoff Frequency ($I_C = -500 \text{ mA}$, $V_{CE} = -10 \text{ V}$, $f = 100 \text{ MHz}$)	f_T	-	100	-	MHz
Input Capacitance ($V_{EB} = 5.0 \text{ V}$, $f = 1.0 \text{ MHz}$)	C_{ibo}	-	360	-	pF
Output Capacitance ($V_{CB} = 10 \text{ V}$, $f = 1.0 \text{ MHz}$)	C_{obo}	-	60	-	pF

Product parametric performance is indicated in the Electrical Characteristics for the listed test conditions, unless otherwise noted. Product performance may not be indicated by the Electrical Characteristics if operated under different conditions.

3. Pulsed Condition: Pulse Width = 300 msec, Duty Cycle $\leq 2\%$.

NSS1C300ET4G

TYPICAL CHARACTERISTICS

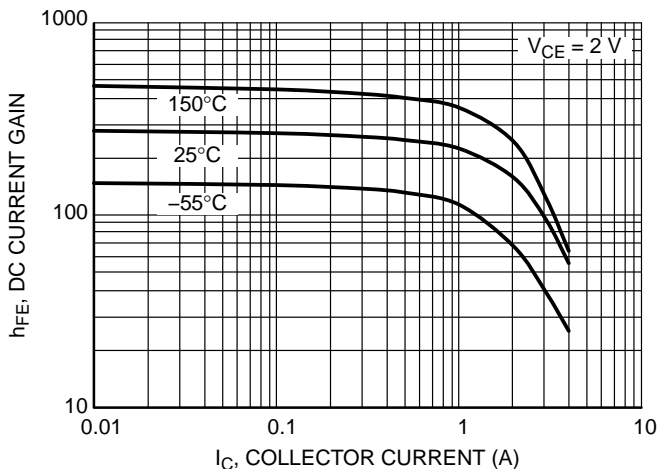

Figure 1. DC Current Gain

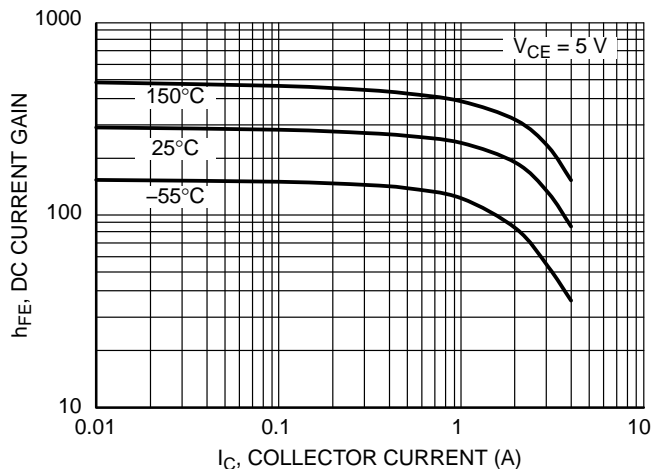

Figure 2. DC Current Gain

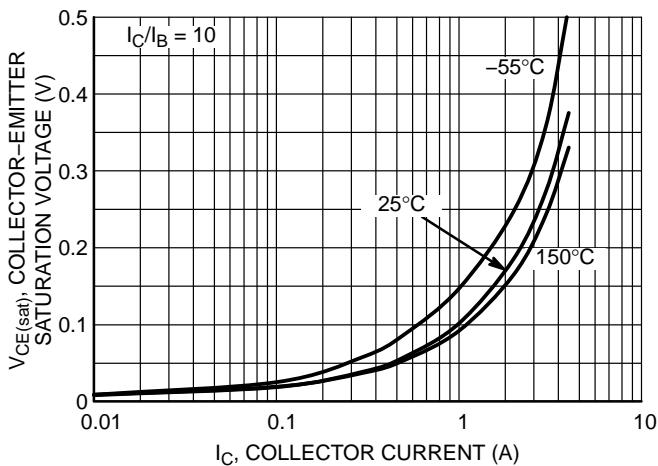

Figure 3. Collector–Emitter Saturation Voltage

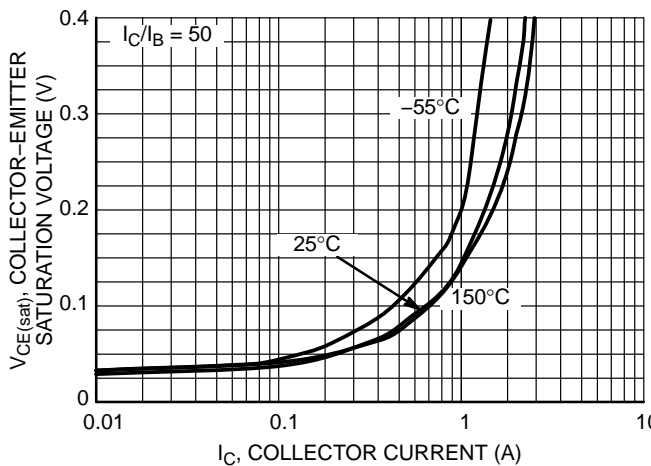

Figure 4. Collector–Emitter Saturation Voltage

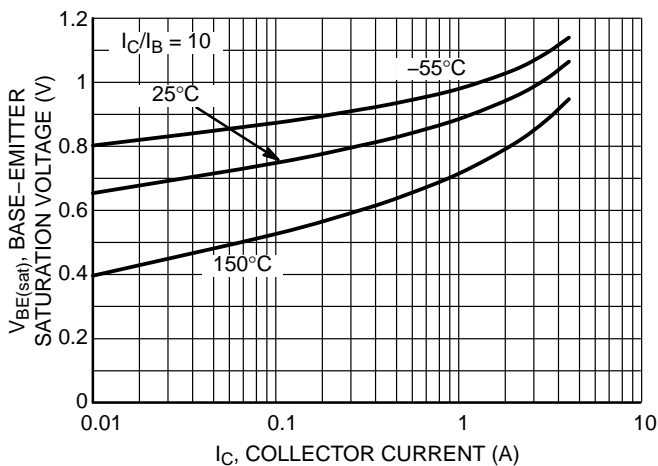

Figure 5. Base–Emitter Saturation Voltage

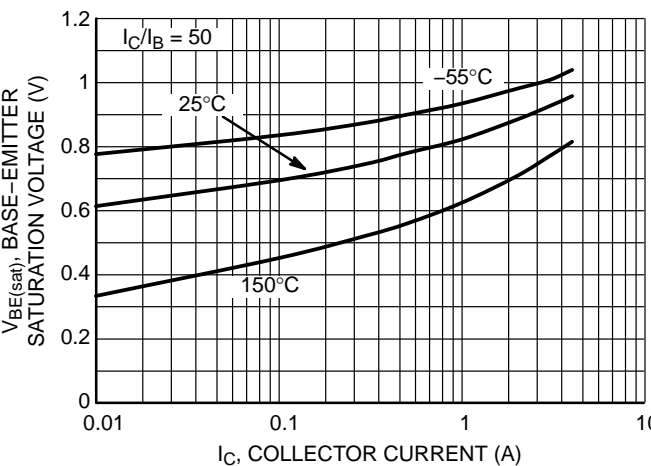

Figure 6. Base–Emitter Saturation Voltage

NSS1C300ET4G

TYPICAL CHARACTERISTICS

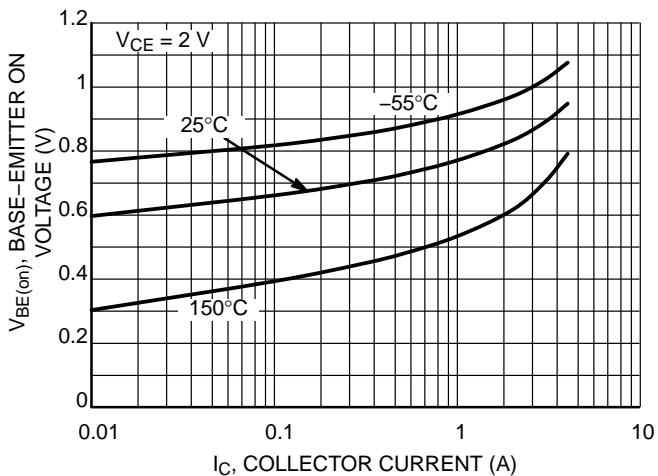

Figure 7. Base-Emitter On Voltage

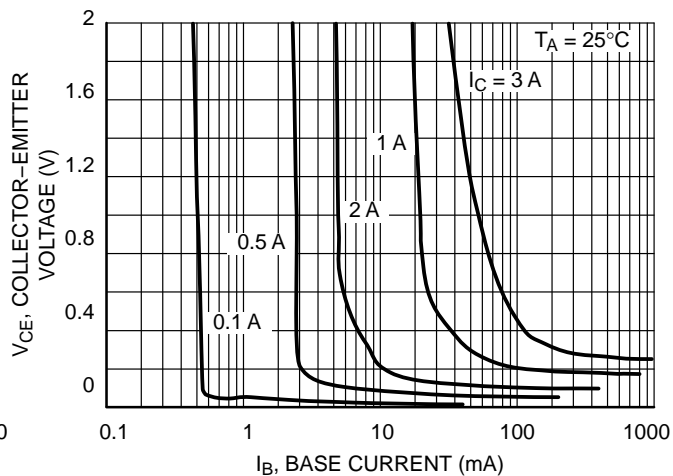

Figure 8. Collector Saturation Region

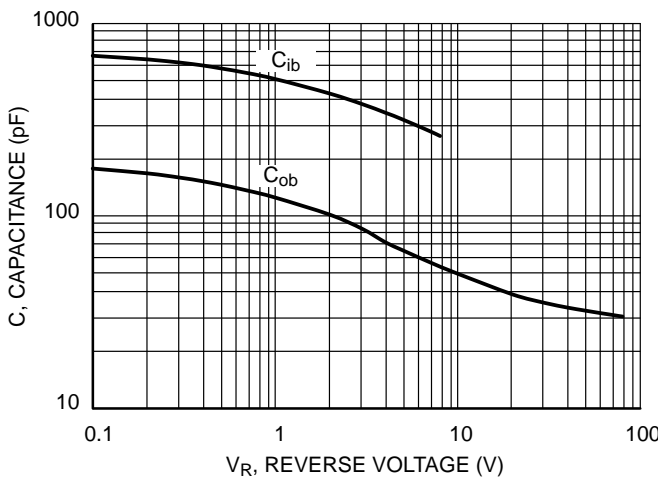

Figure 9. Capacitance

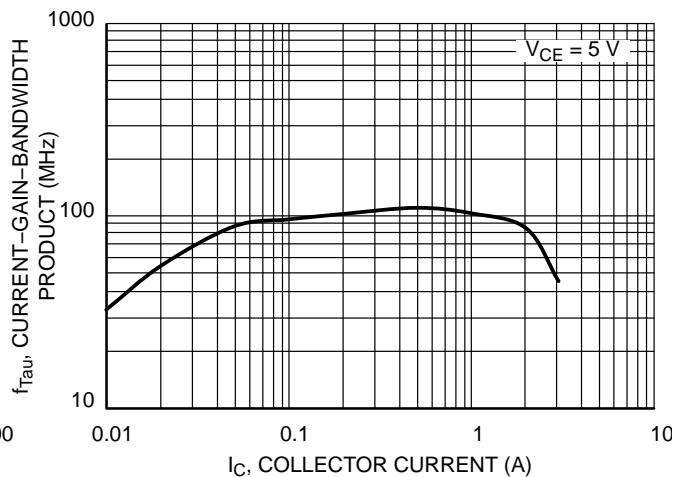

Figure 10. Current-Gain-Bandwidth Product

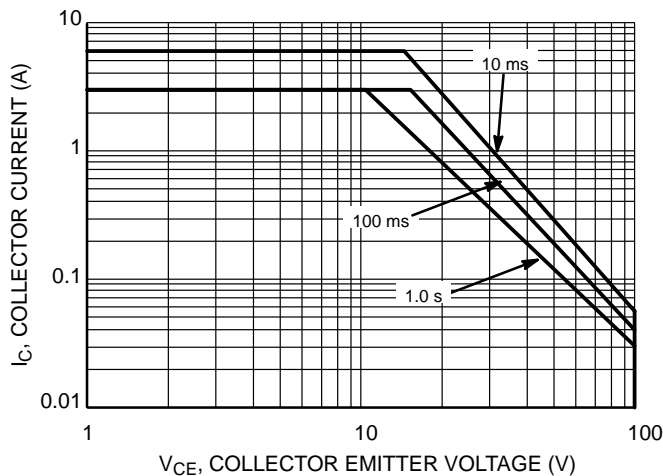

Figure 11. Safe Operating Area

NSS1C300ET4G

TYPICAL CHARACTERISTICS

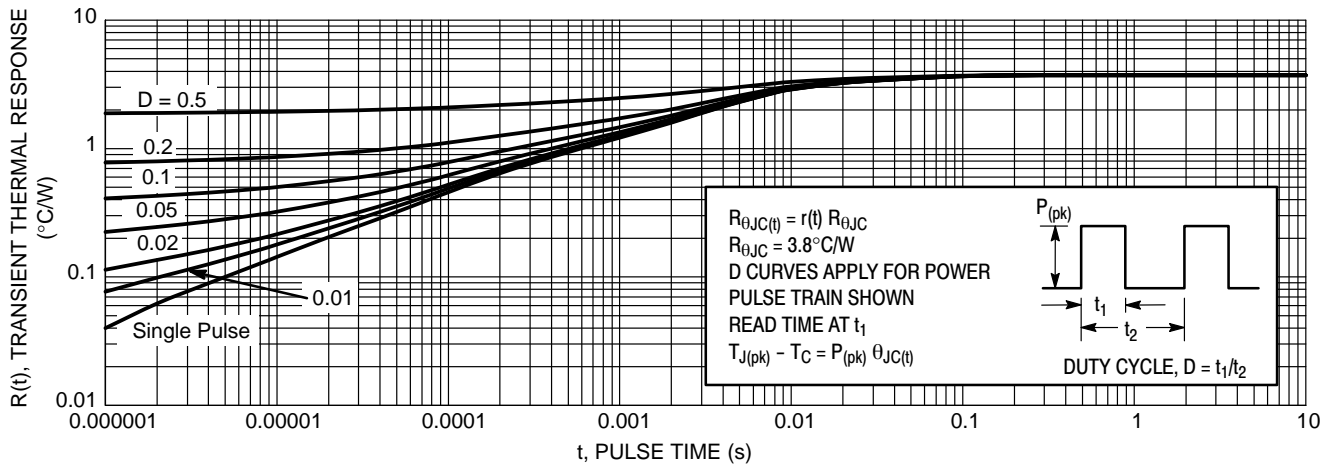
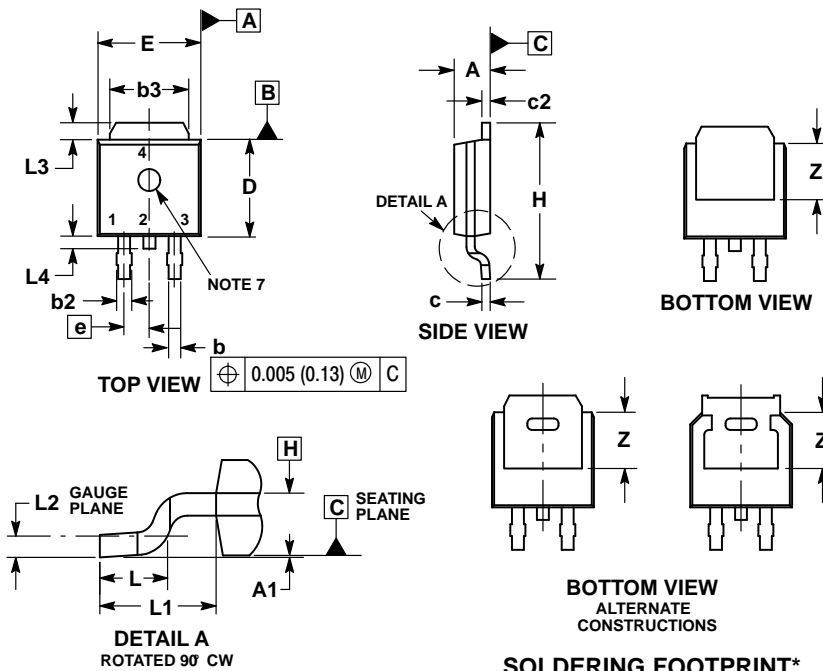

Figure 12. Typical Transient Thermal Response, Junction-to-Case

NSS1C300ET4G

PACKAGE DIMENSIONS

DPAK (SINGLE GAUGE) CASE 369C ISSUE F



NOTES:

1. DIMENSIONING AND TOLERANCING PER ASME Y14.5M, 1994.
2. CONTROLLING DIMENSION: INCHES.
3. THERMAL PAD CONTOUR OPTIONAL WITHIN DIMENSIONS b3, L3 and Z.
4. DIMENSIONS D AND E DO NOT INCLUDE MOLD FLASH, PROTRUSIONS, OR BURRS. MOLD FLASH, PROTRUSIONS, OR GATE BURRS SHALL NOT EXCEED 0.006 INCHES PER SIDE.
5. DIMENSIONS D AND E ARE DETERMINED AT THE OUTERMOST EXTREMES OF THE PLASTIC BODY.
6. DATUMS A AND B ARE DETERMINED AT DATUM PLANE H.
7. OPTIONAL MOLD FEATURE.

DIM	INCHES		MILLIMETERS	
	MIN	MAX	MIN	MAX
A	0.086	0.094	2.18	2.38
A1	0.000	0.005	0.00	0.13
b	0.025	0.035	0.63	0.89
b2	0.028	0.045	0.72	1.14
b3	0.180	0.215	4.57	5.46
c	0.018	0.024	0.46	0.61
c2	0.018	0.024	0.46	0.61
D	0.235	0.245	5.97	6.22
E	0.250	0.265	6.35	6.73
e	0.090 BSC		2.29 BSC	
H	0.370	0.410	9.40	10.41
L	0.055	0.070	1.40	1.78
L1	0.114 REF		2.90 REF	
L2	0.020 BSC		0.51 BSC	
L3	0.035	0.050	0.89	1.27
L4	---	0.040	---	1.01
Z	0.155	---	3.93	---

SOLDERING FOOTPRINT*

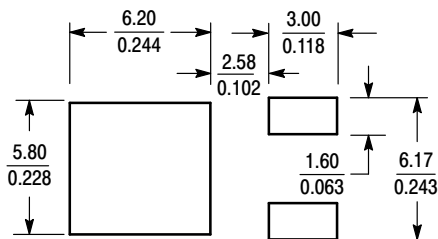

SCALE 3:1 $\left(\frac{\text{mm}}{\text{inches}} \right)$

STYLE 1:

1. PIN 1. BASE
2. COLLECTOR
3. EMITTER
4. COLLECTOR

*For additional information on our Pb-Free strategy and soldering details, please download the ON Semiconductor Soldering and Mounting Techniques Reference Manual, SOLDERRM/D.

ON Semiconductor and are registered trademarks of Semiconductor Components Industries, LLC (SCILLC). SCILLC owns the rights to a number of patents, trademarks, copyrights, trade secrets, and other intellectual property. A listing of SCILLC's product/patent coverage may be accessed at www.onsemi.com/site/pdf/Patent-Marking.pdf. SCILLC reserves the right to make changes without further notice to any products herein. SCILLC makes no warranty, representation or guarantee regarding the suitability of its products for any particular purpose, nor does SCILLC assume any liability arising out of the application or use of any product or circuit, and specifically disclaims any and all liability, including without limitation special, consequential or incidental damages. "Typical" parameters which may be provided in SCILLC data sheets and/or specifications can and do vary in different applications and actual performance may vary over time. All operating parameters, including "Typicals" must be validated for each customer application by customer's technical experts. SCILLC does not convey any license under its patent rights nor the rights of others. SCILLC products are not designed, intended, or authorized for use as components in systems intended for surgical implant into the body, or other applications intended to support or sustain life, or for any other application in which the failure of the SCILLC product could create a situation where personal injury or death may occur. Should Buyer purchase or use SCILLC products for any such unintended or unauthorized application, Buyer shall indemnify and hold SCILLC and its officers, employees, subsidiaries, affiliates, and distributors harmless against all claims, costs, damages, and expenses, and reasonable attorney fees arising out of, directly or indirectly, any claim of personal injury or death associated with such unintended or unauthorized use, even if such claim alleges that SCILLC was negligent regarding the design or manufacture of the part. SCILLC is an Equal Opportunity/Affirmative Action Employer. This literature is subject to all applicable copyright laws and is not for resale in any manner.

PUBLICATION ORDERING INFORMATION

LITERATURE FULFILLMENT:

Literature Distribution Center for ON Semiconductor
P.O. Box 5163, Denver, Colorado 80217 USA
Phone: 303-675-2175 or 800-344-3860 Toll Free USA/Canada
Fax: 303-675-2176 or 800-344-3867 Toll Free USA/Canada
Email: orderlit@onsemi.com

N. American Technical Support: 800-282-9855 Toll Free
USA/Canada
Europe, Middle East and Africa Technical Support:
Phone: 421 33 790 2910
Japan Customer Focus Center
Phone: 81-3-5817-1050

ON Semiconductor Website: www.onsemi.com

Order Literature: <http://www.onsemi.com/orderlit>

For additional information, please contact your local Sales Representative

Компания «Life Electronics» занимается поставками электронных компонентов импортного и отечественного производства от производителей и со складов крупных дистрибьюторов Европы, Америки и Азии.

С конца 2013 года компания активно расширяет линейку поставок компонентов по направлению коаксиальный кабель, кварцевые генераторы и конденсаторы (керамические, пленочные, электролитические), за счёт заключения дистрибьюторских договоров

Мы предлагаем:

- Конкурентоспособные цены и скидки постоянным клиентам.
- Специальные условия для постоянных клиентов.
- Подбор аналогов.
- Поставку компонентов в любых объемах, удовлетворяющих вашим потребностям.
- Приемлемые сроки поставки, возможна ускоренная поставка.
- Доставку товара в любую точку России и стран СНГ.
- Комплексную поставку.
- Работу по проектам и поставку образцов.
- Формирование склада под заказчика.
- Сертификаты соответствия на поставляемую продукцию (по желанию клиента).
- Тестирование поставляемой продукции.
- Поставку компонентов, требующих военную и космическую приемку.
- Входной контроль качества.
- Наличие сертификата ISO.

В составе нашей компании организован Конструкторский отдел, призванный помогать разработчикам, и инженерам.

Конструкторский отдел помогает осуществить:

- Регистрацию проекта у производителя компонентов.
- Техническую поддержку проекта.
- Защиту от снятия компонента с производства.
- Оценку стоимости проекта по компонентам.
- Изготовление тестовой платы монтаж и пусконаладочные работы.



Тел: +7 (812) 336 43 04 (многоканальный)

Email: org@lifeelectronics.ru