

MODULAR CONNECTORS

CL 222 TM

Wire Lead Jack Type

●TM1R-616B44-*

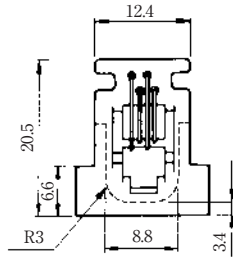
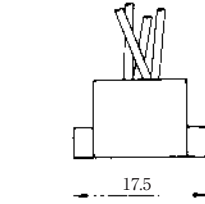
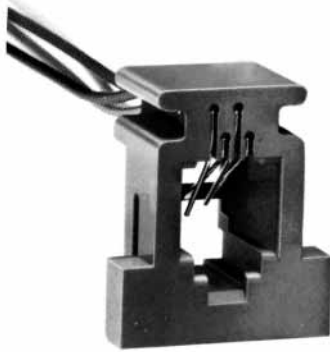

CL No.	Part No.	RoHS
222-4465-0	TM1R-616B44-35S-150M	YES

Color	L (mm)
Yellow	150
Green	150
Red	150
Black	150

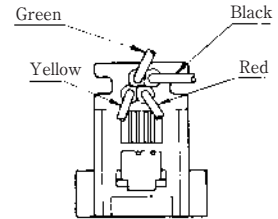
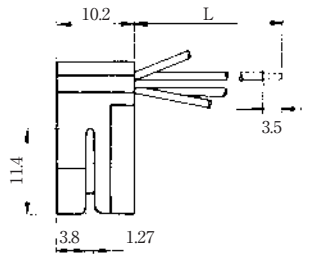

Note: Standard finish color is gray.

●TM1R-616P44-*

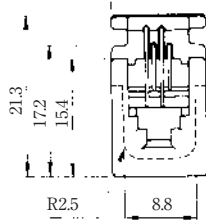
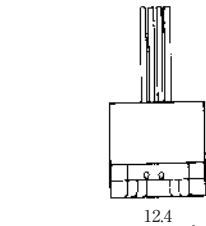
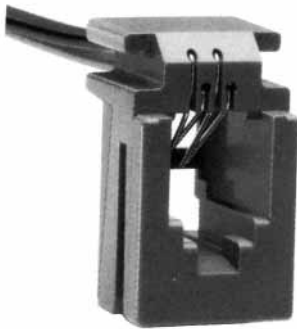

CL No.	Part No.	RoHS
222-4466-2	TM1R-616P44-35S-150M	YES

Color	L (mm)
Yellow	150
Green	150
Red	150
Black	150

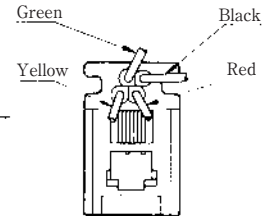
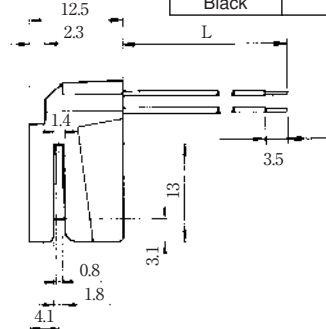

Note: Standard finish color is gray.

●TM1R-616M44-*

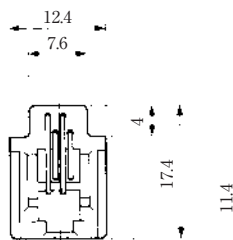
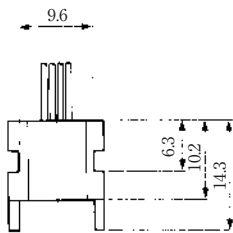

CL No.	Part No.	RoHS
222-4451-5	TM1R-616M44-35S-70M	YES

Color	L (mm)
Yellow	70
Green	70
Red	70
Black	70

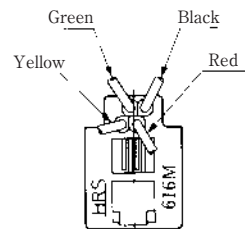
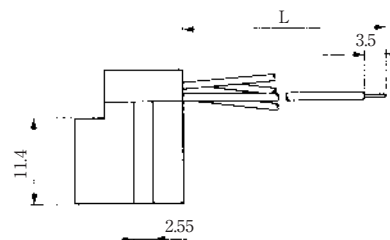

Note: Standard finish color is gray.

MODULAR CONNECTORS

CL 222 TM

TM1R-616W44-*

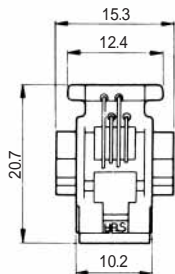
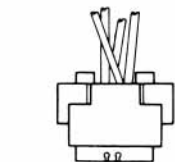
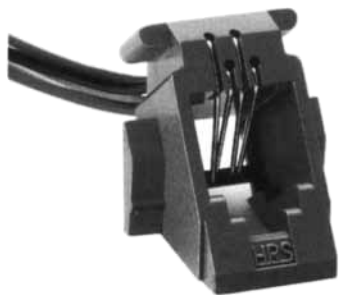

CL No.	Part No.	RoHS
222-4441-1	TM1R-616W44-4S-150M	YES

Color	L (mm)
Yellow	150
Green	150
Red	150
Black	150



Note: Standard finish color is gray.

TM2RD-F44-*

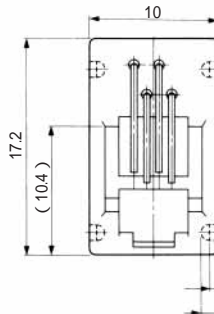

CL No.	Part No.	RoHS
222-4467-5	TM2RD-F44-4S-150M	YES

Color	L (mm)
Yellow	150
Green	150
Red	150
Black	150

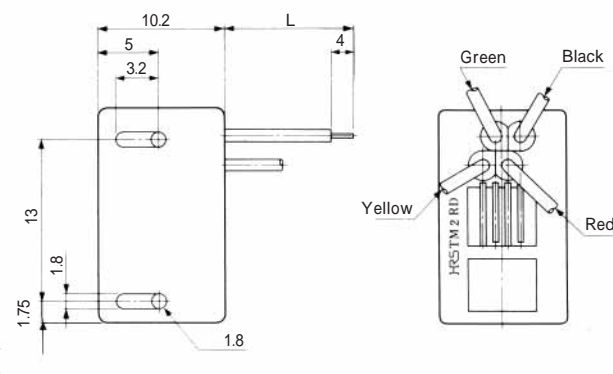

Note: Standard finish color is warm gray.

TM2RDA-F44-*

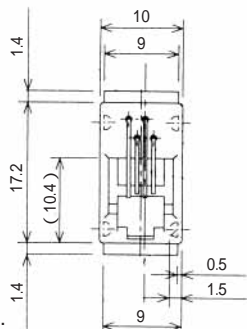
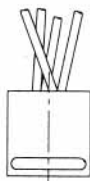
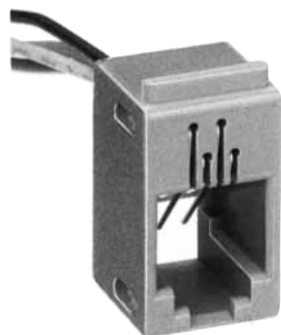

CL No.	Part No.	RoHS
CL222-4440-9	TM2RDA-F44-4S-150M	YES

Color	L (mm)
Yellow	150
Green	150
Red	150
Black	150

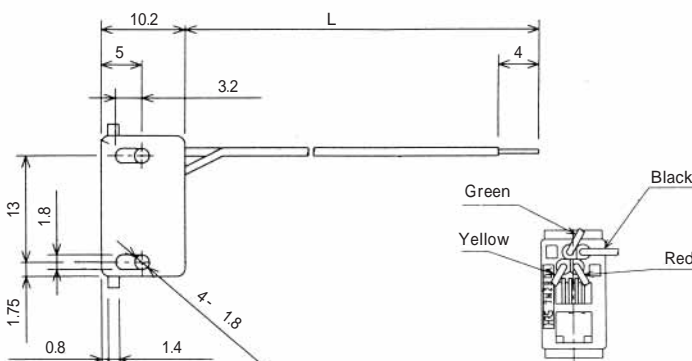

Note: Standard finish color is warm gray.

MODULAR CONNECTORS

CL 222 TM

TM6RA-144- *

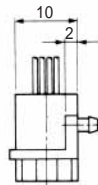
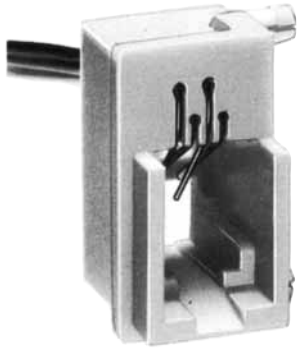

CL No.	Part No.	RoHS
222-4474-0	TM6RA-144-35S-150M	YES

Color	L (mm)
Yellow	150
Green	150
Red	150
Black	150

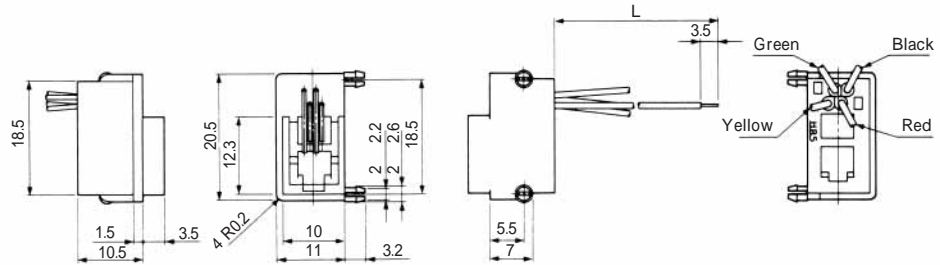

Note: Standard finish color is ash gray.

TM1RV-623K66- *
 TM1RV-623K64- *
 TM1RV-623K62- *

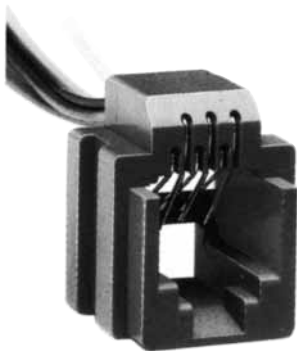

CL No.	Part No.	RoHS
222-4307-9	TM1RV-623K66-4S-150M	YES

Color	L (mm)
White	150
Yellow	150
Green	150
Red	150
Black	150
Blue	150

Color	L (mm)
Yellow	150
Green	150
Red	150
Black	150

CL No.	Part No.	RoHS
222-4470-0	TM1RV-623K62-4S-150M	YES

Color	L (mm)
Green	150
Red	150

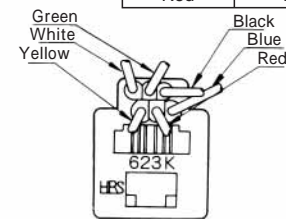
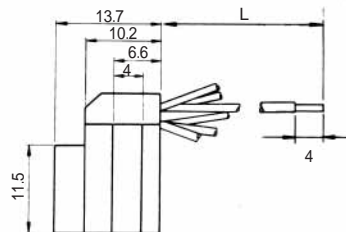
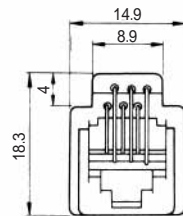

Note1: Standard finish color is gray.

Note2: The drawing is shown sample of TM1RV-623K66- *

TM1RV-623P66- *
 TM1RV-623P64- *

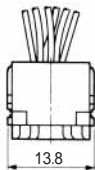
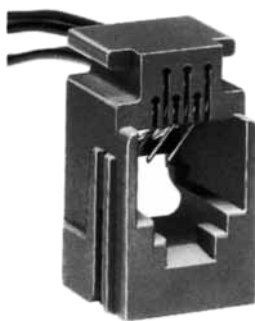

CL No.	Part No.	RoHS
222-4471-2	TM1RV-623P66-35S-150M	YES

Color	L (mm)
White	150
Black	150
Red	150
Green	150
Yellow	150
Blue	150

CL No.	Part No.	RoHS
222-4425-5	TM1RV-623P64-35S-150M	YES

Color	L (mm)
Black	150
Red	150
Green	150
Yellow	150

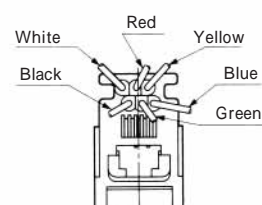
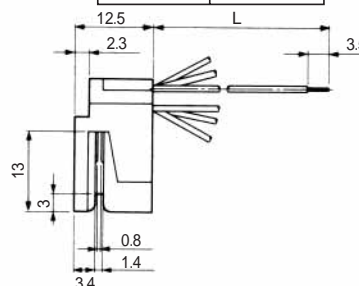
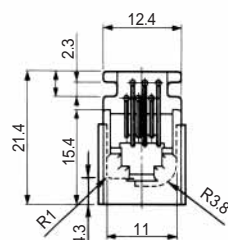

Note1: Standard finish color is gray.

Note2: The drawing is shown sample of TM1RV-623P66- *

MODULAR CONNECTORS

CL 222 TM

●TM7RV-66-*

CL No.	Part No.	RoHS
222-4472-5	TM7RV-A66-35S-150M	YES

Color	L (mm)
White	150
Yellow	150
Green	150
Red	150
Black	150
Blue	150

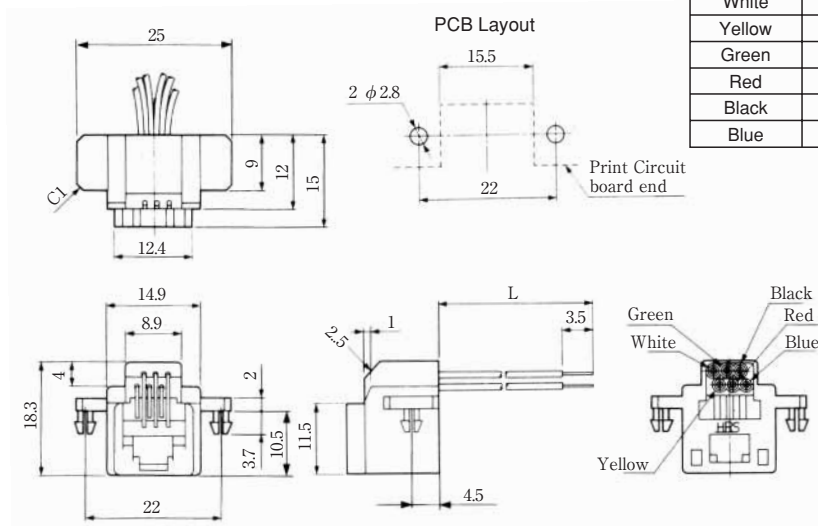
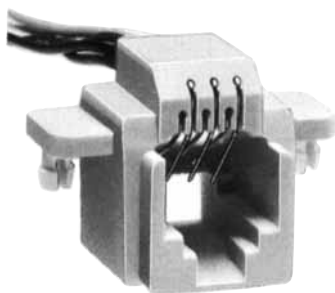

Note: Standard finish color is Vanilla white.

●TM2RGV-L66-*

●TM2RGV-L64-*

●TM2RGV-L62-*

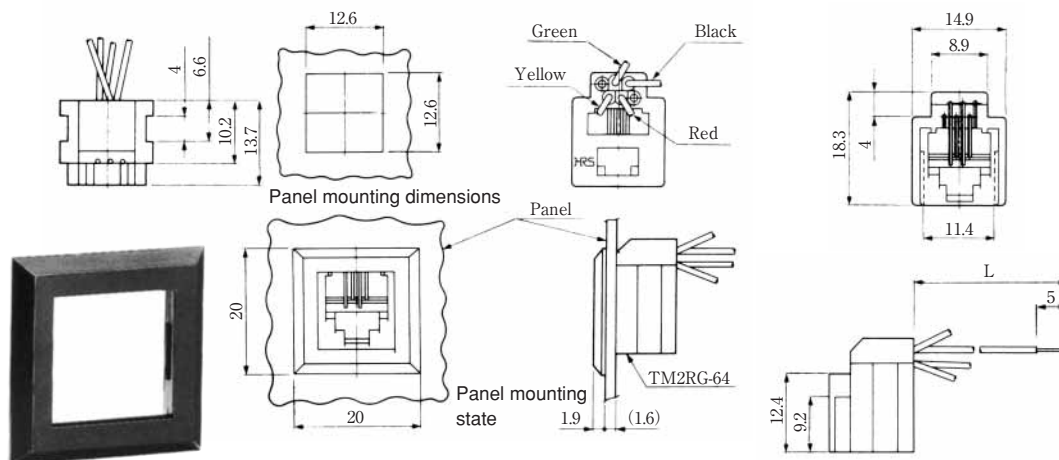

CL No.	Part No.	RoHS
222-4462-1	TM2RGV-L66-4S-150M	YES

Color	L (mm)
White	150
Yellow	150
Green	150
Red	150
Black	150
Blue	150

CL No.	Part No.	RoHS
222-4456-9	TM2RGV-L64-4S-150M	YES

Color	L (mm)
Yellow	150
Green	150
Red	150
Black	150

CL No.	Part No.	RoHS
222-4455-6	TM2RGV-L62-4S-150M	YES

Color	L (mm)
Green	150
Red	150

Note1: Standard finish color is dark brown. Note2: The drawing is shown sample of TM2RGV-L64-*

MODULAR CONNECTORS

CL 222 TM

TM1RV-647AF88- *

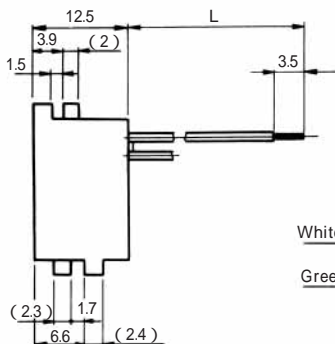
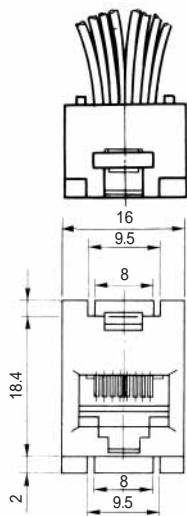

CL No.	Part No.	RoHS
222-4454-3	TM1RV647AF88-35S-150M	YES

Color	L (mm)
Brown	150
White	150
Yellow	150
Green	150
Red	150
Black	150
Blue	150
Orange	150

Note: Standard color is warm gray.

TM2RC-88- *

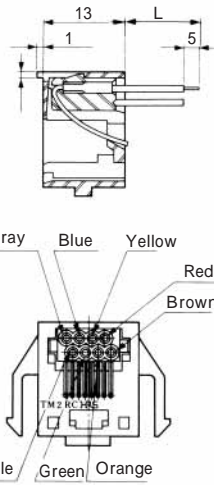
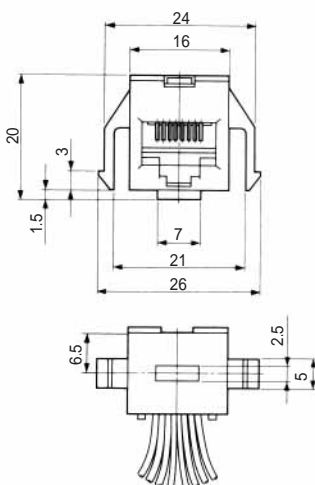
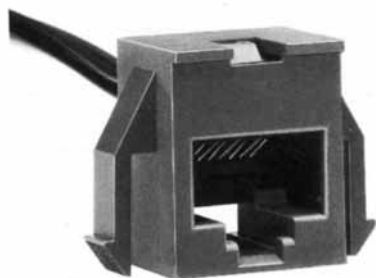

CL No.	Part No.	RoHS
222-4434-6	TM2RCV-M88-5S-450M	YES

Color	L (mm)
Gray	450
Purple	450
Blue	450
Green	450
Yellow	450
Orange	450
Red	450
Brown	450

Note: Standard finish color is beige white.

Компания «Life Electronics» занимается поставками электронных компонентов импортного и отечественного производства от производителей и со складов крупных дистрибьюторов Европы, Америки и Азии.

С конца 2013 года компания активно расширяет линейку поставок компонентов по направлению коаксиальный кабель, кварцевые генераторы и конденсаторы (керамические, пленочные, электролитические), за счёт заключения дистрибьюторских договоров

Мы предлагаем:

- Конкурентоспособные цены и скидки постоянным клиентам.
- Специальные условия для постоянных клиентов.
- Подбор аналогов.
- Поставку компонентов в любых объемах, удовлетворяющих вашим потребностям.
- Приемлемые сроки поставки, возможна ускоренная поставка.
- Доставку товара в любую точку России и стран СНГ.
- Комплексную поставку.
- Работу по проектам и поставку образцов.
- Формирование склада под заказчика.
- Сертификаты соответствия на поставляемую продукцию (по желанию клиента).
- Тестирование поставляемой продукции.
- Поставку компонентов, требующих военную и космическую приемку.
- Входной контроль качества.
- Наличие сертификата ISO.

В составе нашей компании организован Конструкторский отдел, призванный помогать разработчикам, и инженерам.

Конструкторский отдел помогает осуществить:

- Регистрацию проекта у производителя компонентов.
- Техническую поддержку проекта.
- Защиту от снятия компонента с производства.
- Оценку стоимости проекта по компонентам.
- Изготовление тестовой платы монтаж и пусконаладочные работы.



Тел: +7 (812) 336 43 04 (многоканальный)

Email: org@lifeelectronics.ru