

# Reference Only

Spec. No. JENF243D-0007M-01

P 1/ 12

## Chip EMIFIL LC Combined Array Type NFA18S□□□□□1A45□ Reference Specification

### 1. Scope

This reference specification applies to Chip EMIFIL LC Combined Array Type NFA18S Series.

### 2. Part Numbering

Product ID NF Structure A Dimension 18 Features SL Cut-off Frequency 307 Characteristics V Rated Voltage 1A Electrode 4 Dimension 5 Packaging Code L  
(L×W) (T) (L: Taping / B: Bulk)

### 3. Rating

| Customer Part Number | MURATA Part Number | Cut-off Frequency [MHz] | Insertion Loss (I.L.)(dB) |         |         |         |         | Insulation Resistance [MΩ min.] | Rated Voltage [V(DC)] | Rated Current [mA(DC)] | Withstanding Voltage [V(DC)] |
|----------------------|--------------------|-------------------------|---------------------------|---------|---------|---------|---------|---------------------------------|-----------------------|------------------------|------------------------------|
|                      |                    |                         | 300 MHz                   | 400 MHz | 480 MHz | 800 MHz | 900 MHz |                                 |                       |                        |                              |
|                      | NFA18SL307V1A45L   | 300                     | 6                         | -       | -       | 20      | 20      | 1000                            | 10                    | 100                    | 30                           |
|                      | NFA18SL307V1A45B   |                         | max.                      |         |         | min.    | min.    |                                 |                       |                        |                              |
|                      | NFA18SL407V1A45L   | 400                     | -                         | 6       | -       | 18      | 18      | 1000                            | 10                    | 100                    | 30                           |
|                      | NFA18SL407V1A45B   |                         |                           | max.    |         | min.    | min.    |                                 |                       |                        |                              |
|                      | NFA18SL487V1A45L   | 480                     | -                         | -       | 6       | 15      | 15      | 1000                            | 10                    | 100                    | 30                           |
|                      | NFA18SL487V1A45B   |                         |                           |         | max.    | min.    | min.    |                                 |                       |                        |                              |

<Capacitance> NFA18SL307V1A45□ : 22pF (typ.)      <Inductance> NFA18SL307V1A45□ : 23 nH (typ.)  
 NFA18SL407V1A45□ : 15pF (typ.)      NFA18SL407V1A45□ : 23 nH (typ.)  
 NFA18SL487V1A45□ : 8pF (typ.)      NFA18SL487V1A45□ : 23 nH (typ.)

- Operating Temperature : -55°C to +125°C (Includes self-heating.)
- Storage Temperature: -55°C to +125°C

| Customer Part Number | MURATA Part Number | Cut-off Frequency [MHz] | Insertion Loss (I.L.)(dB) |         |         |         |         |         |       | Insulation Resistance [MΩ min.] | Rated Voltage [V(DC)] | Rated Current [mA(DC)] | Withstanding Voltage [V(DC)] |
|----------------------|--------------------|-------------------------|---------------------------|---------|---------|---------|---------|---------|-------|---------------------------------|-----------------------|------------------------|------------------------------|
|                      |                    |                         | 130 MHz                   | 180 MHz | 200 MHz | 350 MHz | 470 MHz | 900 MHz | 2 GHz |                                 |                       |                        |                              |
|                      | NFA18SL137V1A45L   | 130                     | 6                         | -       | -       | -       | 25      | 25      | -     | 1000                            | 10                    | 50                     | 30                           |
|                      | NFA18SL137V1A45B   |                         | max                       |         |         |         | min     | min     |       |                                 |                       |                        |                              |
|                      | NFA18SL187V1A45L   | 180                     | -                         | 6       | -       | -       | 20      | 20      | -     | 1000                            | 10                    | 50                     | 30                           |
|                      | NFA18SL187V1A45B   |                         |                           | max     |         |         | min     | min     |       |                                 |                       |                        |                              |
|                      | NFA18SL207V1A45L   | 200                     | -                         | -       | 6       | -       | 15      | 15      | -     | 1000                            | 10                    | 50                     | 30                           |
|                      | NFA18SL207V1A45B   |                         |                           |         | max     |         | min     | min     |       |                                 |                       |                        |                              |
|                      | NFA18SL357V1A45L   | 350                     | -                         | -       | -       | 6       | -       | 15      | 13    | 1000                            | 10                    | 35                     | 30                           |
|                      | NFA18SL357V1A45B   |                         |                           |         |         | max     |         | min     | min   |                                 |                       |                        |                              |

<Capacitance> NFA18SL137V1A45□ : 40pF(typ.)      <Inductance> NFA18SL137V1A45□ : 60nH(typ.)  
 NFA18SL187V1A45□ : 22pF(typ.)      NFA18SL187V1A45□ : 60nH(typ.)  
 NFA18SL207V1A45□ : 15pF(typ.)      NFA18SL207V1A45□ : 60nH(typ.)  
 NFA18SL357V1A45□ : 4pF(typ.)      NFA18SL357V1A45□ : 50nH(typ.)

- Operating Temperature : -40°C to +85°C (Includes self-heating.)
- Storage Temperature: -40°C to +85°C

| Customer Part Number | MURATA Part Number | Cut-off Frequency [MHz] | Insertion Loss (I.L.)(dB) |         |         | Insulation Resistance [MΩ min.] | Rated Voltage [V(DC)] | Rated Current [mA(DC)] | Withstanding Voltage [V(DC)] |
|----------------------|--------------------|-------------------------|---------------------------|---------|---------|---------------------------------|-----------------------|------------------------|------------------------------|
|                      |                    |                         | 50 MHz                    | 500 MHz | 1 GHz   |                                 |                       |                        |                              |
|                      | NFA18SL506X1A45L   | 50                      | 6 max.                    | 30 min. | 25 min. | 1000                            | 10                    | 25                     | 30                           |
|                      | NFA18SL506X1A45B   |                         |                           |         |         |                                 |                       |                        |                              |

<Capacitance> NFA18SL506X1A45□ : 73pF(typ.)      <Inductance> NFA18SL506X1A45□ : 110nH(typ.)

- Operating Temperature : -40°C to +85°C (Includes self-heating.)
- Storage Temperature: -40°C to +85°C

# Reference Only

Spec. No. JENF243D-0007M-01

P 2 / 12

| Customer Part Number | MURATA Part Number | Cut-off Frequency [MHz] | Insertion Loss (I.L.)(dB) |         |         | Insulation Resistance [MΩ min.] | Rated Voltage [V(DC)] | Rated Current [mA(DC)] | Withstanding Voltage [V(DC)] |
|----------------------|--------------------|-------------------------|---------------------------|---------|---------|---------------------------------|-----------------------|------------------------|------------------------------|
|                      |                    |                         | 220 MHz                   | 900 MHz | 2 GHz   |                                 |                       |                        |                              |
|                      | NFA18SL227V1A45L   | 220                     | 6 max.                    | 30 min. | 30 min. | 1000                            | 10                    | 25                     | 30                           |
|                      | NFA18SL227V1A45B   |                         |                           |         |         |                                 |                       |                        |                              |

<Capacitance> NFA18SL227V1A45□ : 27pF(typ.)      <Inductance> NFA18SL227V1A45□ : 65nH(typ.)

- Operating Temperature : -40°C to +85°C (Includes self-heating.)
- Storage Temperature: -40°C to +85°C

| Customer Part Number | MURATA Part Number | Cut-off Frequency [MHz] | Insertion Loss (I.L.)(dB) |         |         |         |         |         | Insulation Resistance [MΩ min.] | Rated Voltage [V(DC)] | Rated Current [mA(DC)] | Withstanding Voltage [V(DC)] |
|----------------------|--------------------|-------------------------|---------------------------|---------|---------|---------|---------|---------|---------------------------------|-----------------------|------------------------|------------------------------|
|                      |                    |                         | 180 MHz                   | 200 MHz | 500 MHz | 900 MHz | 1.5 GHz | 2 GHz   |                                 |                       |                        |                              |
|                      | NFA18SD187X1A45L   | 180                     | 6 max.                    | —       | 15 max. | 20 min. | 20 min. | 20 min. | 1000                            | 10V                   | 25                     | 30                           |
|                      | NFA18SD187X1A45B   |                         |                           |         |         |         |         |         |                                 |                       |                        |                              |
|                      | NFA18SD207X1A45L   | 200                     | —                         | 6 max.  | 13 min. | 20 min. | 20 min. | 20 min. | 1000                            | 10V                   | 25                     | 30                           |
|                      | NFA18SD207X1A45B   |                         |                           |         |         |         |         |         |                                 |                       |                        |                              |

<Capacitance> NFA18SD187X1A45□ : 22pF(typ.)      <Inductance> NFA18SD187X1A45□ : 90nH(typ.)  
 NFA18SD207X1A45□ : 15pF(typ.)      NFA18SD207X1A45□ : 90nH(typ.)

- Operating Temperature : -40°C to +85°C (Includes self-heating.)
- Storage Temperature: -40°C to +85°C

#### 4. Standard Testing Condition

< Unless otherwise specified >

Temperature : Ordinary Temp. / 15 °C to 35 °C  
 Humidity: Ordinary Humidity / 25 % ( RH ) to 85 % ( RH )

< In case of doubt >

Temperature: 20 °C ± 2 °C  
 Humidity: 60 % ( RH ) to 70 % ( RH )  
 Atmospheric pressure: 86 kPa to 106 kPa

#### 5. Style and Dimensions

NFA18SL307/407/487

NFA18SL137/187/207/227/357/506, NFA18SD

(Top View)

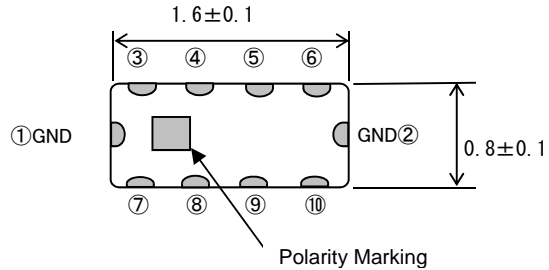
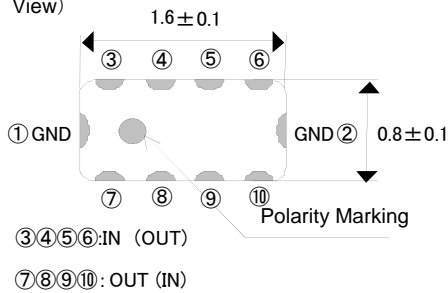

(Side View)

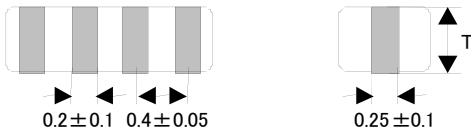

|                                     | T(mm)                                  |
|-------------------------------------|--|
| NFA18SL307/357/407/487              | 0.5 ± 0.1                              |
| NFA18SL137/187/207/227/506, NFA18SD | 0.6 ± <sup>0.05</sup> / <sub>0.1</sub> |

(Bottom View)

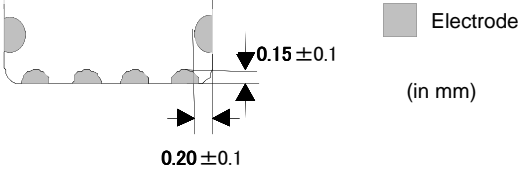

# Reference Only

Spec. No. JENF243D-0007M-01

P 3/ 12

■ Equivalent Circuits

NFA18SL307/407/487

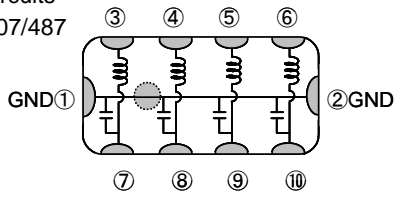

NFA18SL227

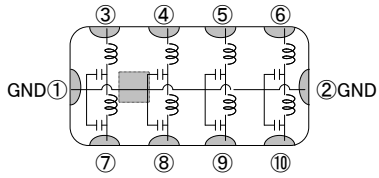

NFA18SL137/187/207/357/506

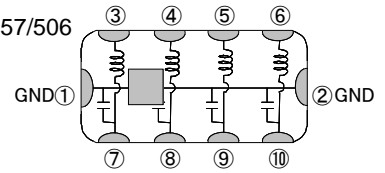

NFA18SD

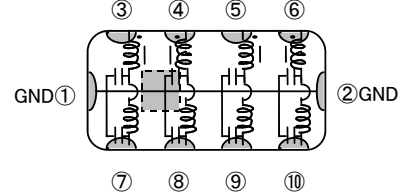

■ Unit Mass (Typ.) 0.004g

■ Insertion Loss Characteristics (I.L.) (Typ.)

(50Ω system)

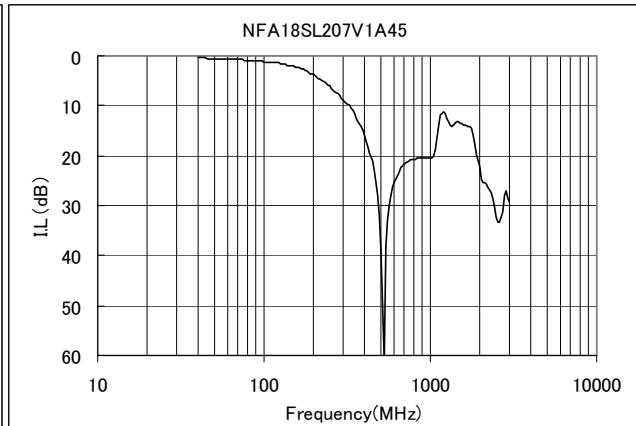
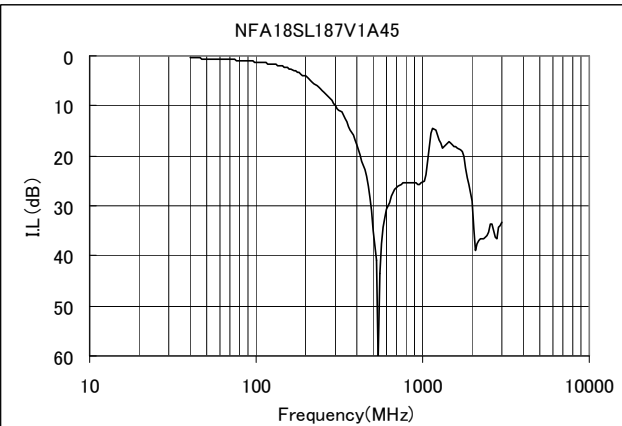
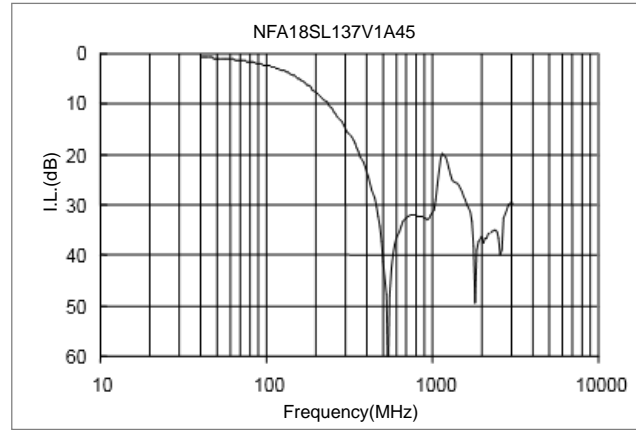
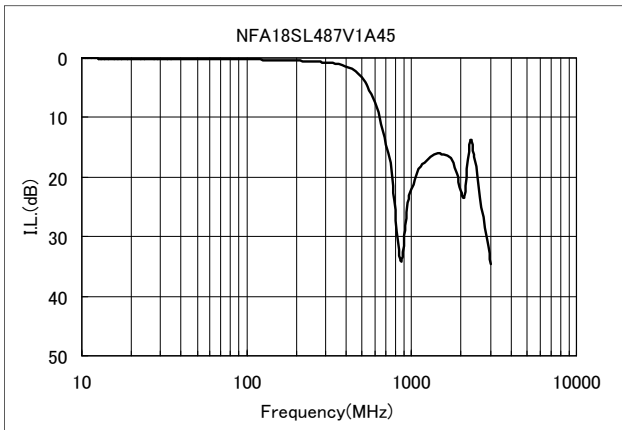
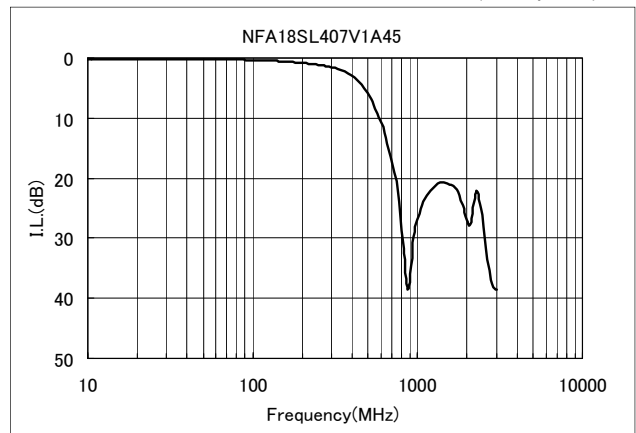
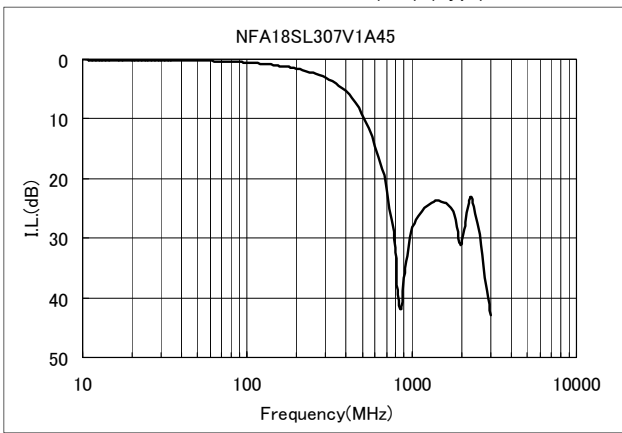

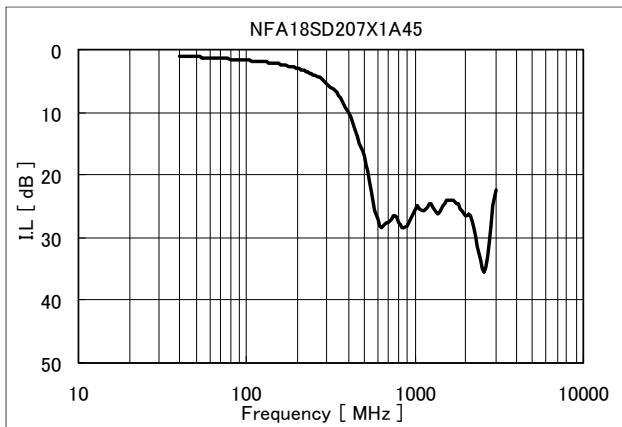
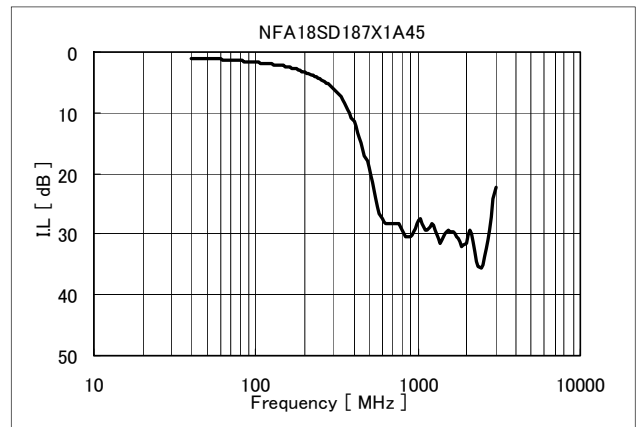
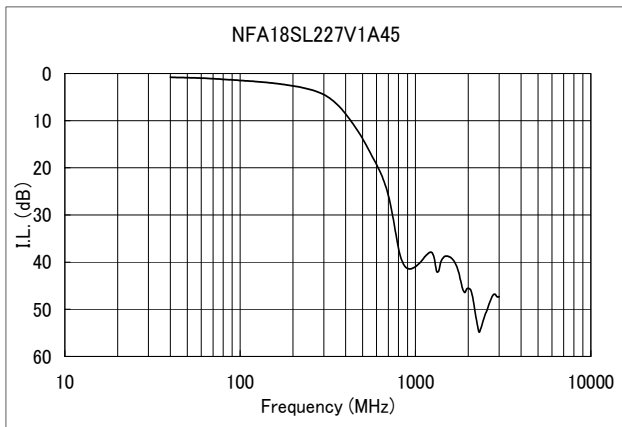
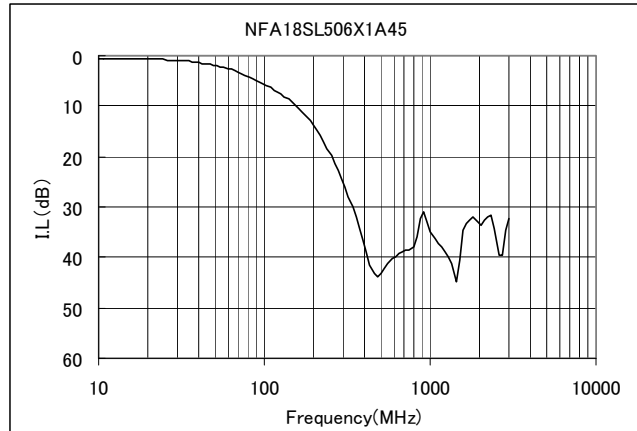
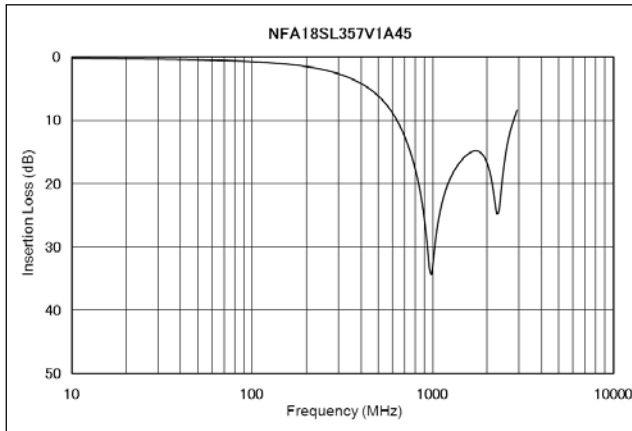

## 6. Marking

In case of polarity marking on the left side as shown the equivalent circuits(item 5), coil are upside.  
 Only NFA18SL227/NFA18SD is a double L-type structure, so it is located from the upper side in order of  
 coil→capacitor→coil→capacitor.

# Reference Only

## 7. Electrical Performance

| No. | Item                        | Specification                  | Test Method  |
|-----|-----------------------------|--------------------------------|--|
| 7.1 | Insertion Loss (I.L.)       | Meet item 3.                   | <p style="text-align: center;">*Method of measurement based on MIL-STD-220</p> <p>Insertion Loss = <math>20 \log (E_0 / E_1)</math><br/> <math>E_0</math> : Level without FILTER (short)<br/> <math>E_1</math> : Level with FILTER</p> |
| 7.2 | Insulation Resistance(I.R.) |                                | <ul style="list-style-type: none"> <li>• Voltage : Rated Voltage</li> <li>• Time : 1 minutes</li> </ul>  |
| 7.3 | Withstanding Voltage        | Products shall not be damaged. | <ul style="list-style-type: none"> <li>• Test Voltage : 30V(DC)</li> <li>• Time : 1 to 5 s</li> <li>• Charge Current : 50 mA max.</li> </ul>   |

## 8. Mechanical Performance

| No.                   | Item                                  | Specification  | Test Method  |            |                |             |                       |  |
|-----------------------|---------------------------------------|--|--|------------|----------------|-------------|-----------------------|--|
| 8.1                   | Appearance and Dimensions             | Meet item 5.   | Visual Inspection and measured with Micrometer caliper and Microscope.   |            |                |             |                       |  |
| 8.2                   | Solderability                         | Electrodes shall be at least 90% covered with new solder coating.  | <ul style="list-style-type: none"> <li>• Flux : Ethanol solution of rosin, 25(wt)%</li> <li>• Pre-heat : 150°C, 60 s</li> <li>• Solder : Sn-3.0Ag-0.5Cu</li> <li>• Solder Temperature : 245 ± 3°C</li> <li>• Immersion Time : 3±1 s</li> <li>• Immersion and emersion rates : 25mm / s</li> </ul>    |            |                |             |                       |  |
| 8.3                   | Resistance to soldering heat          | Meet Table 1.<br><u>Table 1</u>  | <ul style="list-style-type: none"> <li>• Flux : Ethanol solution of rosin, 25(wt)%</li> <li>• Pre-heat : 150°C, 60 s</li> <li>• Solder : Sn-3.0Ag-0.5Cu</li> <li>• Solder Temperature : 270 ± 5°C</li> <li>• Immersion Time : 10 ± 1 s</li> <li>• Immersion and emersion rates : 25mm / s</li> </ul> |            |                |             |                       |  |
|                       |                                       | <table border="1" style="width: 100%; border-collapse: collapse; text-align: center;"> <tr> <td style="width: 50%;">Appearance</td> <td>No damaged</td> </tr> <tr> <td>Insertion Loss</td> <td rowspan="2">meet item 3</td> </tr> <tr> <td>Insulation Resistance</td> </tr> </table> | Appearance   | No damaged | Insertion Loss | meet item 3 | Insulation Resistance |  |
| Appearance            | No damaged                            |  |  |            |                |             |                       |  |
| Insertion Loss        | meet item 3                           |  |  |            |                |             |                       |  |
| Insulation Resistance |                                       |  |  |            |                |             |                       |  |
| 8.4                   | Resistance to soldering heat (Reflow) |  | <ul style="list-style-type: none"> <li>• Pre-heat : 150~180°C, 90±30 s</li> <li>• Heating: 230 °C min., 60 s max.</li> <li>• Peak Temperature: 260 °C, 10 s max.</li> <li>• Solder : Sn-3.0Ag-0.5Cu</li> <li>• The number of Times : 2 times</li> </ul>  |            |                |             |                       |  |
| 8.5                   | Drop                                  | Products shall be no failure after tested.   | <p>It shall be dropped on concrete or steel board.</p> <ul style="list-style-type: none"> <li>• Method: Free fall</li> <li>• Height: 1m</li> <li>• Attitude from which the product is dropped : 3 directions</li> <li>• The Number of Time: 3 times for each direction (Total 9 times)</li> </ul>    |            |                |             |                       |  |
| 8.6                   | Bonding Strength                      | The electrodes shall be no failure after tested.   | <p>It shall be soldered on the glass-epoxy substrate.</p> <ul style="list-style-type: none"> <li>• Applying Force (F): 9.8 N</li> <li>• Applying Time : 30 s</li> </ul> <p style="text-align: right;">(in mm)</p>  |            |                |             |                       |  |

# Reference Only

| No. | Item             | Specification                              | Test Method  |
|-----|------------------|--|--|
| 8.7 | Vibration        | Meet Table 1.                              | It shall be soldered on the glass-epoxy substrate. <ul style="list-style-type: none"> <li>• Oscillation Frequency: 10 to 2000 to 10Hz for 20 minutes.</li> <li>• Total amplitude 1.5 mm or Acceleration amplitude 196m/s<sup>2</sup> whichever is smaller.</li> <li>• Time: A period of 2 hours in each of 3 mutually perpendicular directions. (Total 6 hours)</li> </ul> |
| 8.8 | Bending Strength | Products shall be no failure after tested. | It shall be soldered on the glass-epoxy substrate (t = 1.0mm). <ul style="list-style-type: none"> <li>• Deflection: 2.0 mm</li> <li>• Keeping Time: 30 s</li> </ul> <div style="text-align: center;"> <p style="text-align: center;">Pressure jig<br/>R230<br/>F<br/>Deflection<br/>45 45<br/>Product (in mm)</p> </div>   |

## 9. Environment Performance

It shall be soldered on the glass-epoxy substrate.

| No. | Item                | Specification | Test Method   |
|-----|---------------------|---------------|---|
| 9.1 | Temperature Cycling | Meet Table 1. | <b>【NFA18SL307/407/487】</b> <ul style="list-style-type: none"> <li>• 1 Cycle                             <ol style="list-style-type: none"> <li>1 step: -55 ± 0<sub>3</sub> °C / 30 ± 3<sub>0</sub> minutes</li> <li>2 step: Room Temperature / within 3 minutes</li> <li>3 step: +125 ± 3<sub>0</sub> °C / 30 ± 3<sub>0</sub> minutes</li> <li>4 step: Room Temperature / within 3 minutes</li> </ol> </li> <li>• Total of 100 cycles</li> </ul><br><b>【NFA18SL137/187/207/227/357/506,NFA18SD】</b> <ul style="list-style-type: none"> <li>• 1 Cycle                             <ol style="list-style-type: none"> <li>1 step: -40 ± 0<sub>3</sub> °C / 30 ± 3<sub>0</sub> minutes</li> <li>2 step: Room Temperature / within 3 minutes</li> <li>3 step: +85 ± 3<sub>0</sub> °C / 30 ± 3<sub>0</sub> minutes</li> <li>4 step: Room Temperature / within 3 minutes</li> </ol> </li> <li>• Total of 100 cycles</li> </ul> |
| 9.2 | Humidity            |               | <ul style="list-style-type: none"> <li>• Temperature : 40 ± 2 °C</li> <li>• Humidity : 90 to 95%(RH)</li> <li>• Time : 1000± 48<sub>0</sub> hours</li> </ul>  |
| 9.3 | Heat Life           |               | <b>【NFA18SL307/407/487】</b> <ul style="list-style-type: none"> <li>• Temperature: 125 ± 2 °C</li> <li>• Test Voltage: Rated Voltage × 200%</li> <li>• Charge Current: 50 mA max.</li> <li>• Time: 1000 ± 48<sub>0</sub> hours</li> </ul><br><b>【NFA18SL137/187/207/227/357/506,NFA18SD】</b> <ul style="list-style-type: none"> <li>• Temperature: 85 ± 2 °C</li> <li>• Test Voltage: Rated Voltage × 200%</li> <li>• Charge Current: 50 mA max.</li> <li>• Time: 1000 ± 48<sub>0</sub> hours</li> </ul>   |
| 9.4 | Cold Resistance     |               | <b>【NFA18SL307/407/487】</b> <ul style="list-style-type: none"> <li>• Temperature: -55 ± 2 °C</li> <li>• Time: 1000± 48<sub>0</sub> hours</li> </ul><br><b>【NFA18SL137/187/207/227/357/506,NFA18SD】</b> <ul style="list-style-type: none"> <li>• Temperature: -40 ± 2 °C</li> <li>• Time: 1000± 48<sub>0</sub> hours</li> </ul>  |

# Reference Only

Spec. No. JENF243D-0007M-01

P 7 / 12

## 10. Tape Packaging

### 10.1. Appearance and Dimensions (8mm-wide plastic tape)

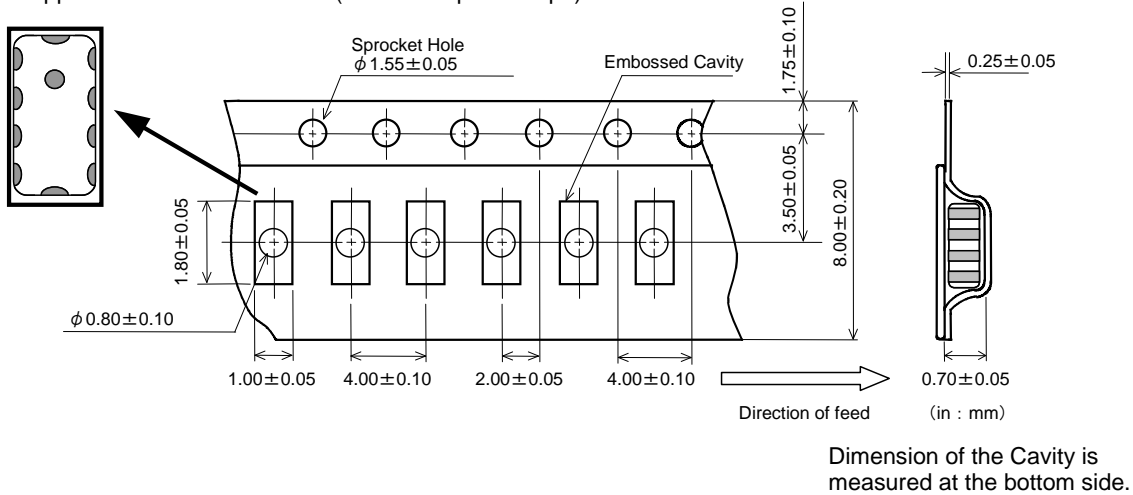

### 10.2. Specification of Taping

(1) Packing quantity (standard quantity)

4000 pcs. / reel

(2) Packing Method

Products shall be packaged in the cavity of the plastic tape and sealed with cover tape.

(3) Sprocket Hole

The sprocket holes are to the right as the tape is pulled toward the user.

(4) Spliced point

The cover tape have no spliced point.

(5) Missing components number

Missing components number within 0.1% of the number per reel or 1 pc., whichever is greater, and are not continuous. The specified quantity per reel is kept.

### 10.3. Pull Strength of Plastic Tape and Cover Tape

|              |          |
|--------------|----------|
| Plastic tape | 5N min.  |
| Cover tape   | 10N min. |

### 10.4. Peeling off force of cover tape

0.2N to 0.7N (minimum value is typical)

Speed of Peeling off : 300 mm / min

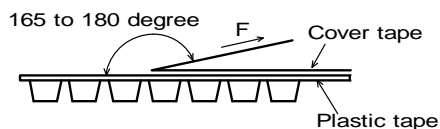

### 10.5. Dimensions of Leader-tape, Trailer and Reel

There shall be leader-tape (top tape and empty tape) and trailer-tape (empty tape) as follows.

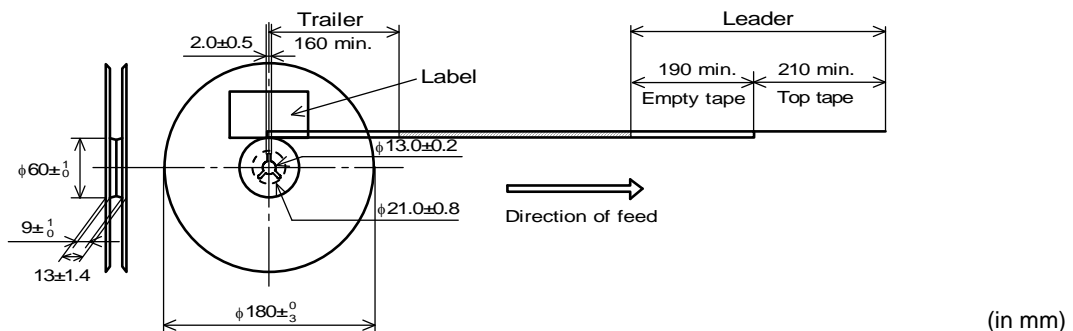

# Reference Only

Spec. No. JENF243D-0007M-01

P 8 / 12

## 10.6. Marking for reel

Customer part number, MURATA part number, Inspection number(\*1), RoHS marking(\*2), Quantity, etc

\*1) « Expression of Inspection No. »     □□    OOOO    XXXX  
   (1)       (2)       (3)

(1) Factory Code  
 (2) Date                    First digit             : Year / Last digit of year  
     Second digit          : Month / Jan. to Sep. → 1 to 9, Oct. to Dec. → O, N, D  
     Third, Fourth digit : Day

(3) Serial No.

\*2) « Expression of RoHS marking »     ROHS – Y (Δ)  
    (1) (2)

(1) RoHS regulation conformity parts.  
 (2) MURATA classification number

## 10.7. Marking for Outside package (corrugated paper box)

Customer name, Purchasing Order Number, Customer Part Number, MURATA part number, RoHS marking(\*2), Quantity, etc

## 10.8. Specification of Outer Case

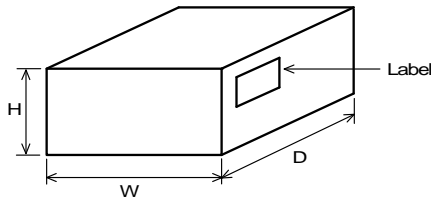

| Outer Case Dimensions (mm) |     |    | Standard Reel Quantity in Outer Case (Reel) |
|----------------------------|-----|----|---|
| W                          | D   | H  |   |
| 186                        | 186 | 93 | 5   |

\* Above Outer Case size is typical. It depends on a quantity of an order.

## 11. Standard Land Dimensions

The chip EMI filter suppresses noise by conducting the high-frequency noise element to ground. Therefore, to get enough noise reduction, feed through holes which is connected to ground-plane should be arranged according to the figure to reinforce the ground-pattern.

- < Standard land dimensions for reflow >  
 • Side on which chips are mounted

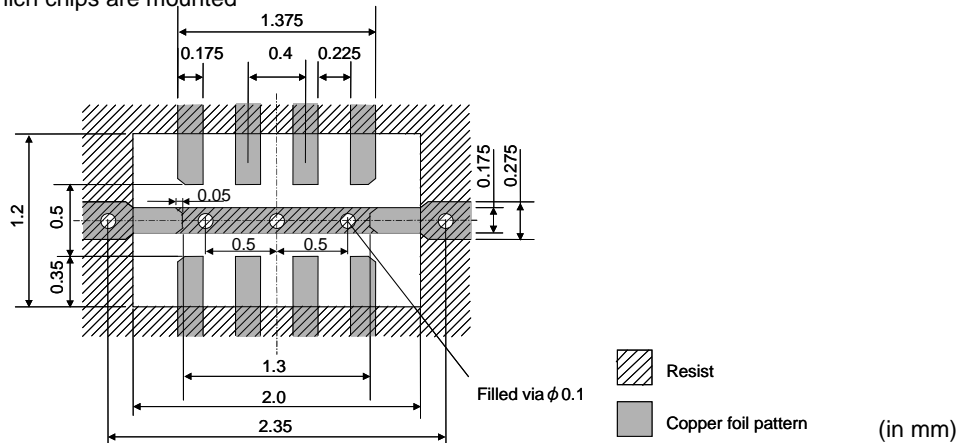

## 12. ⚠ Caution

### Limitation of Applications

Please contact us before using our products for the applications listed below which require especially high reliability for the prevention of defects which might directly cause damage to the third party's life, body or property.

- (1) Aircraft equipment    (2) Aerospace equipment    (3) Undersea equipment    (4) Power plant control equipment
- (5) Medical equipment    (6) Transportation equipment(automobiles, trains, ships, etc.)    (7) Traffic signal equipment
- (8) Disaster prevention / crime prevention equipment    (9) Data-processing equipment
- (10) Applications of similar complexity or with reliability requirements comparable to the applications listed in the above



# Reference Only

### 13. Notice

Products can only be soldered with reflow.  
 This product is designed for solder mounting.  
 Please consult us in advance for applying other mounting method such as conductive adhesive.

#### 13.1. Mounting direction of a product

In the case of mounting, Polarity Marking should surely serve as the upper surface.  
 When mounted upside down, since the Polarity Marking is formed with the conductor, it has a possibility that the short-circuit between terminals may occur.

#### 13.2. Flux and Solder

|        |   |
|--------|---|
| Flux   | Use rosin-based flux, Do not use highly acidic flux (with chlorine content exceeding 0.2(wt)%).<br>Do not use water soluble flux. |
| Solder | Use Sn-3.0Ag-0.5Cu solder   |

Other flux (except above) Please contact us for details, then use.

#### 13.3. Note for Assembling

< Thermal Shock >

Pre-heating should be in such a way that the temperature difference between solder and products surface is limited to 100°C max. Also cooling into solvent after soldering should be in such a way that the temperature difference is limited to 100°C max.

#### 13.4. Attention Regarding P.C.B. Bending

The following shall be considered when designing P.C.B.'s and laying out products.

- (1) P.C.B. shall be designed so that products are not subject to the mechanical stress for board warpage.  
 [Products direction]

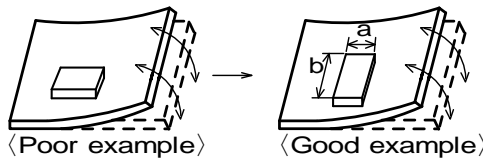

Products shall be located in the sideways direction (Length:  $a < b$ ) to the mechanical stress.

- (2) Components location on P.C.B. separation.

It is effective to implement the following measures, to reduce stress in separating the board.  
 It is best to implement all of the following three measures; however, implement as many measures as possible to reduce stress.

| Contents of Measures   | Stress Level |
|--|--------------|
| (1) Turn the mounting direction of the component parallel to the board separation surface. | $A > D$ *1   |
| (2) Add slits in the board separation part.  | $A > B$      |
| (3) Keep the mounting position of the component away from the board separation surface.    | $A > C$      |

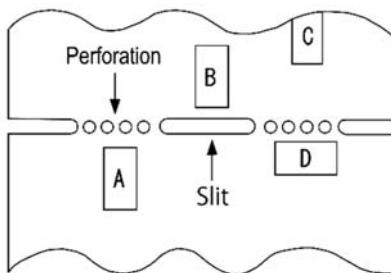

\*1  $A > D$  is valid when stress is added vertically to the perforation as with Hand Separation. If a Cutting Disc is used, stress will be diagonal to the PCB, therefore  $A > D$  is invalid.

- (3) Mounting Components Near Screw Holes

When a component is mounted near a screw hole, it may be affected by the board deflection that occurs during the tightening of the screw. Mount the component in a position as far away from the screw holes as possible.

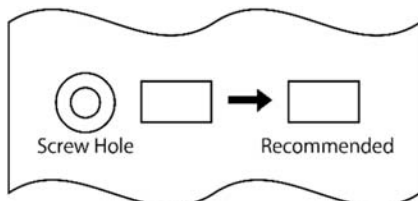

# Reference Only

Spec. No. JENF243D-0007M-01

P 10/ 12

## 13.5. Pre-heating Temperature

Soldering shall be handled so that the difference between pre-heating temperature and solder temperature shall be limited to 100°C max. to avoid the heat stress for the products.

## 13.6. Reflow Soldering

### 1) Soldering paste printing for reflow

- Standard thickness of solder paste: 100µm to 150µm.
- Use the solder paste printing pattern of the below pattern.
- For the resist and copper foil pattern, use standard land dimensions.

Standard printing pattern of solder paste.

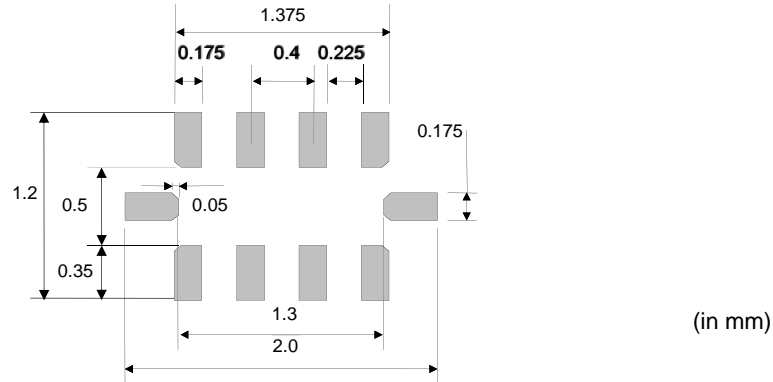

### 2) Soldering Conditions

Standard soldering profile and the limit soldering profile is as follows.

The excessive limit soldering conditions may cause leaching of the electrode and / or resulting in the deterioration of product quality.

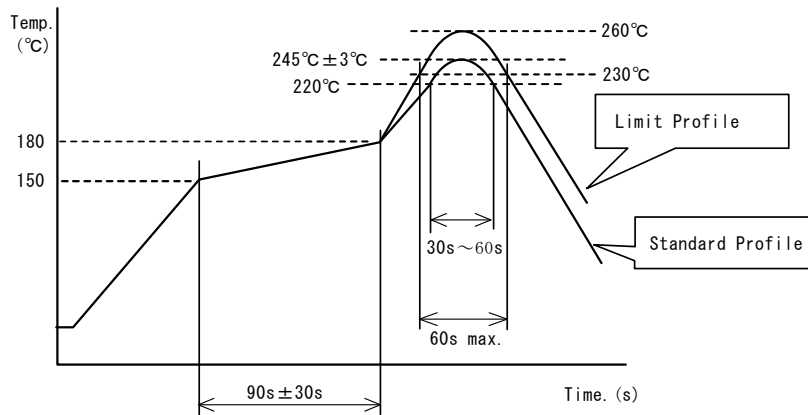

|                  | Standard Profile    | Limit Profile        |
|------------------|---------------------|----------------------|
| Pre-heating      | 150~180°C、90s±30s   |                      |
| Heating          | above 220°C、30s~60s | above 230°C、60s max. |
| Peak temperature | 245±3°C             | 260°C,10s            |
| Cycle of reflow  | 2 times             | 2 times              |

## 13.7. Reworking with Soldering iron

The following conditions shall be strictly followed when using a soldering iron.

- Pre-heating : 150°C, 1 min
- Tip temperature : 350°C max.
- Soldering time : 3(+1,-0) s
- Soldering iron output : 30W max.
- Tip diameter : φ 3mm max.
- Times : 2times max.

Note : Do not directly touch the products with the tip of the soldering iron in order to prevent the crack on the ceramic material due to the thermal shock.

# Reference Only

Spec. No. JENF243D-0007M-01

P 11/ 12

## 13.8. Solder Volume

Solder shall be used not to be exceeded as shown below.

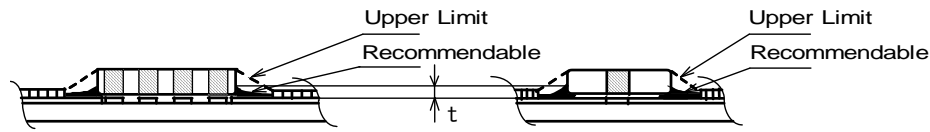

$$1/3T \leq t \leq T (T: \text{Chip thickness})$$

Accordingly increasing the solder volume, the mechanical stress to product is also increased. Excessive solder volume may cause the failure of mechanical or electrical performance.

## 13.9. Cleaning Conditions

Products shall be cleaned on the following conditions.

- (1) Cleaning temperature shall be limited to 60°C max. (40°C max. for IPA.)
- (2) Ultrasonic cleaning shall comply with the following conditions, with avoiding the resonance phenomenon at the mounted products and P.C.B.

Power: 20W / l max. Frequency: 28 kHz to 40 kHz Time: 5 minutes max.

### (3) Cleaner

#### 1. Cleaner

- Isopropyl alcohol (IPA)

#### 2. Aqueous agent

- PINE ALPHA ST-100S

- (4) There shall be no residual flux and residual cleaner after cleaning.

In the case of using aqueous agent, products shall be dried completely after rinse with de-ionized water in order to remove the cleaner.

### (5) Other cleaning

Please contact us.

## 13.10. Operating Environment

Do not use this product under the following environmental conditions, on deterioration of the performance, such as insulation resistance may result from the use.

- (1) in the corrodible atmosphere (acidic gases, alkaline gases, chlorine, sulfur gases, organic gases and etc.)
- (2) in the atmosphere where liquid such as organic solvent, may splash on the products.
- (3) in the atmosphere where the temperature / humidity changes rapidly and it is easy to dew.

## 13.11. Resin coating

The capacitance and inductance value may change and/or it may affect on the product's performance due to high cure-stress of resin to be used for coating / molding products. So please pay your careful attention when you select resin. In prior to use, please make the reliability evaluation with the product mounted in your application set.

## 13.12. Handling of a substrate

After mounting products on a substrate, do not apply any stress to the product caused by bending or twisting to the substrate when cropping the substrate, inserting and removing a connector from the substrate or tightening screw to the substrate.

Excessive mechanical stress may cause cracking in the product.

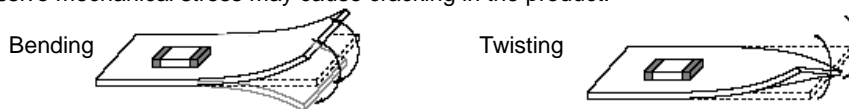

## 13.13. Storage condition

### (1) Storage period

Use the products within 12 months after delivered.

Solderability should be checked if this period is exceeded.

### (2) Storage environment condition

- Products should be stored in the warehouse on the following conditions.

Temperature: -10 to +40°C

Humidity: 15 to 85% relative humidity

No rapid change on temperature and humidity

- Don't keep products in corrosive gases such as sulfur, chlorine gas or acid, or it may cause oxidization of electrode, resulting in poor solderability.

- Products should be stored on the palette for the prevention of the influence from humidity, dust and so on.

- Products should be stored in the warehouse without heat shock, vibration, direct sunlight and so on.

- Products should be stored under the airtight packaged condition.

### (3) Delivery

Care should be taken when transporting or handling product to avoid excessive vibration or mechanical shock.

# Reference Only

Spec. No. JENF243D-0007M-01

P 12/ 12

**14.  Note**

- (1) Please make sure that your product has been evaluated in view of your specifications with our product being mounted to your product.
- (2) You are requested not to use our product deviating from the reference specifications.
- (3) The contents of this reference specification are subject to change without advance notice. Please approve our product specifications or transact the approval sheet for product specifications before ordering.

Компания «Life Electronics» занимается поставками электронных компонентов импортного и отечественного производства от производителей и со складов крупных дистрибьюторов Европы, Америки и Азии.

С конца 2013 года компания активно расширяет линейку поставок компонентов по направлению коаксиальный кабель, кварцевые генераторы и конденсаторы (керамические, пленочные, электролитические), за счёт заключения дистрибьюторских договоров

Мы предлагаем:

- Конкурентоспособные цены и скидки постоянным клиентам.
- Специальные условия для постоянных клиентов.
- Подбор аналогов.
- Поставку компонентов в любых объемах, удовлетворяющих вашим потребностям.
- Приемлемые сроки поставки, возможна ускоренная поставка.
- Доставку товара в любую точку России и стран СНГ.
- Комплексную поставку.
- Работу по проектам и поставку образцов.
- Формирование склада под заказчика.
- Сертификаты соответствия на поставляемую продукцию (по желанию клиента).
- Тестирование поставляемой продукции.
- Поставку компонентов, требующих военную и космическую приемку.
- Входной контроль качества.
- Наличие сертификата ISO.

В составе нашей компании организован Конструкторский отдел, призванный помогать разработчикам, и инженерам.

Конструкторский отдел помогает осуществить:

- Регистрацию проекта у производителя компонентов.
- Техническую поддержку проекта.
- Защиту от снятия компонента с производства.
- Оценку стоимости проекта по компонентам.
- Изготовление тестовой платы монтаж и пусконаладочные работы.



Тел: +7 (812) 336 43 04 (многоканальный)

Email: [org@lifeelectronics.ru](mailto:org@lifeelectronics.ru)