

2.6 GHz capable, 10 W carrying power (at 2.6 GHz), 50Ω/75Ω impedance and 1 Form C relays

RE RELAYS (ARE)

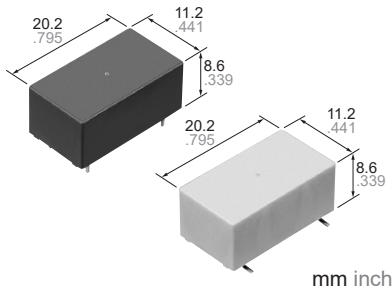

FEATURES

- Excellent high frequency characteristics (to 2.6GHz)
- Surface-mount type also available
- Compact and slim size
Size: 20.2(L) × 11.2(W) × 8.9(H)* mm
.795(L) × .441(W) × .350(H) inch
*The height of Surface-mount type is 9.6 mm .378 inch size.

TYPICAL APPLICATIONS

- Broadcasting and video markets.**
 - Digital broadcasting equipment
 - STB/tuner
- Communications market**
 - Antennae switching
 - All types of wireless devices

If you consider using applications with low level loads or with high frequency switching, please consult us.

Protective construction: Sealed type

ORDERING INFORMATION

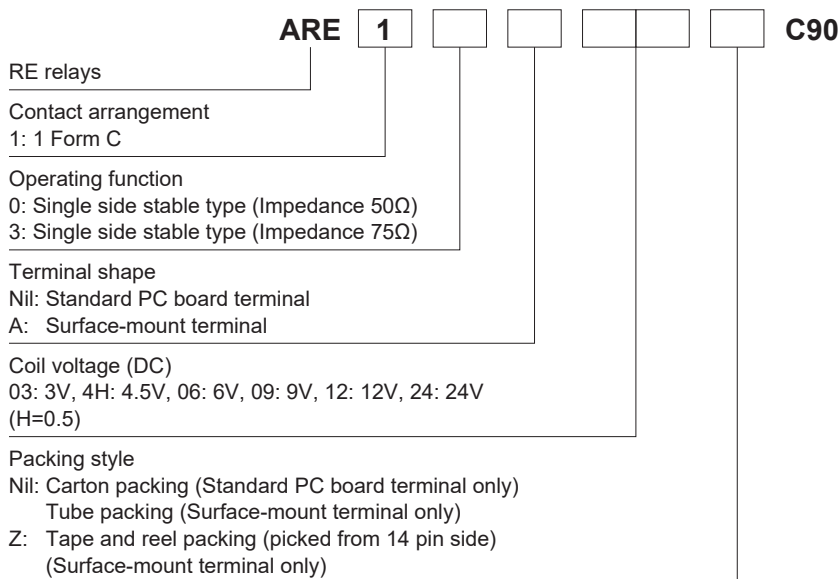

TYPES

1. Standard PC board terminal

| Rated voltage | Part No. | | Standard packing | |
|---------------|---|---|------------------|----------|
| | Single side stable type (Impedance 50Ω) | Single side stable type (Impedance 75Ω) | Carton | Case |
| 3 V DC | ARE1003C90 | ARE1303C90 | 50 pcs. | 500 pcs. |
| 4.5 V DC | ARE104HC90 | ARE134HC90 | | |
| 6 V DC | ARE1006C90 | ARE1306C90 | | |
| 9 V DC | ARE1009C90 | ARE1309C90 | | |
| 12 V DC | ARE1012C90 | ARE1312C90 | | |
| 24 V DC | ARE1024C90 | ARE1324C90 | | |

2. Surface-mount terminal

1) Tube package

| Rated voltage | Part No. | | Standard packing | |
|---------------|---|---|------------------|----------|
| | Single side stable type (Impedance 50Ω) | Single side stable type (Impedance 75Ω) | Tube | Case |
| 3 V DC | ARE10A03C90 | ARE13A03C90 | 25 pcs. | 200 pcs. |
| 4.5 V DC | ARE10A4HC90 | ARE13A4HC90 | | |
| 6 V DC | ARE10A06C90 | ARE13A06C90 | | |
| 9 V DC | ARE10A09C90 | ARE13A09C90 | | |
| 12 V DC | ARE10A12C90 | ARE13A12C90 | | |
| 24 V DC | ARE10A24C90 | ARE13A24C90 | | |

2) Tape and reel package

| Rated voltage | Part No. | | Standard packing | |
|---------------|---|---|------------------|----------|
| | Single side stable type (Impedance 50Ω) | Single side stable type (Impedance 75Ω) | Tape and reel | Case |
| 3 V DC | ARE10A03ZC90 | ARE13A03ZC90 | 400 pcs. | 800 pcs. |
| 4.5 V DC | ARE10A4HZC90 | ARE13A4HZC90 | | |
| 6 V DC | ARE10A06ZC90 | ARE13A06ZC90 | | |
| 9 V DC | ARE10A09ZC90 | ARE13A09ZC90 | | |
| 12 V DC | ARE10A12ZC90 | ARE13A12ZC90 | | |
| 24 V DC | ARE10A24ZC90 | ARE13A24ZC90 | | |

RATING

1.Coil data

• Operating characteristics such as 'Operate voltage' and 'Release voltage' are influenced by mounting conditions, ambient temperature, etc.

Therefore, please use the relay within $\pm 5\%$ of rated coil voltage.

• 'Initial' means the condition of products at the time of delivery.

| Rated voltage | Pick-up voltage* (at 20°C 68°F) | Drop-out voltage* (at 20°C 68°F) | Rated operating current [$\pm 10\%$] (at 20°C 68°F) | Coil resistance [$\pm 10\%$] (at 20°C 68°F) | Rated operating power | Max. allowable voltage |
|---------------|---|---|--|--|-----------------------|---|
| 3 V DC | 75%V or less of rated voltage (Initial) | 10%V or more of rated voltage (Initial) | 66.7 mA | 45 Ω | 200 mW | 110%V (at 60°C 140°F) 150%V (at 20°C 68°F) of rated voltage |
| 4.5 V DC | | | 44.4 mA | 101 Ω | | |
| 6 V DC | | | 33.3 mA | 180 Ω | | |
| 9 V DC | | | 22.2 mA | 405 Ω | | |
| 12 V DC | | | 16.7 mA | 720 Ω | | |
| 24 V DC | | | 8.3 mA | 2,880 Ω | | |

* Square, pulse drive (JIS C5442)

2. Specifications

| Characteristics | Item | Specifications | |
|--|--|---|---|
| Contact data | Arrangement | 1 Form C | |
| | Contact resistance (initial) | Max. 100mΩ (By voltage drop 10V AC 1mA) | |
| | Contact material | Gold plating | |
| | Contact rating | 1W (at 2.6 GHz [Impedance 50Ω, V.S.W.R. Max. 1.7] [Impedance 75Ω, V.S.W.R. Max. 1.5]) 10mA 24V DC (resistive) | |
| | Contact input power | Max. 10W (at 2.6GHz [Impedance 50Ω, V.S.W.R. Max. 1.7] [Impedance 75Ω, V.S.W.R. Max. 1.5]) | |
| | Max. switching voltage | 30V DC | |
| | Max. switching current | 0.5A DC | |
| High frequency characteristics (Initial) (Impedance 50Ω) | V.S.W.R. | Max. 1.3 (to 900MHz), Max. 1.7 (to 2.6GHz) | |
| | Insertion loss | Max. 0.2dB (to 900MHz), Max. 0.7dB (to 2.6GHz) | |
| | Isolation | Min. 55dB (to 900MHz), Min. 35dB (to 2.6GHz) | |
| High frequency characteristics (Initial) (Impedance 75Ω) | V.S.W.R. | Max. 1.2 (to 900MHz), Max. 1.5 (to 2.6GHz) | |
| | Insertion loss | Max. 0.2dB (to 900MHz), Max. 0.5dB (to 2.6GHz) | |
| | Isolation | Min. 55dB (to 900MHz), Min. 35dB (to 2.6GHz) | |
| Insulation resistance (Initial) | | Min. 100MΩ (at 500V DC, Measured portion is the same as the case of dielectric voltage.) | |
| Breakdown voltage (Initial) | Between open contacts | 500 Vrms for 1min. (detection current: 10mA) | |
| | Between contact and coil | 1,000 Vrms for 1min. (detection current: 10mA) | |
| | Between contact and earth terminal | 500 Vrms for 1min. (detection current: 10mA) | |
| Time characteristics | Operate time (initial) | Max. 10ms (at 20°C 68°F, at rated voltage, without bounce) | |
| | Release time (initial) | Max. 5ms (at 20°C 68°F, at rated voltage, without bounce, without diode) | |
| Mechanical characteristics | Shock resistance | Functional | Min. 500 m/s ² (half-sine shock pulse: 11ms; detection time: 10μs) |
| | | Destructive | Min. 1,000m/s ² (half-sine shock pulse: 6ms) |
| | Vibration resistance | Functional | 10 to 55 Hz at double amplitude of 3mm (detection time: 10μs) |
| | | Destructive | 10 to 55 Hz at double amplitude of 5mm |
| Expected life | Mechanical | Min. 10 ⁸ (at 180 times/min.) | |
| | Electrical | Min. 3×10 ⁵ (1W, 2.6GHz, [Impedance 50Ω, V.S.W.R.≤1.7] [Impedance 75Ω, V.S.W.R.≤1.5]) Min. 3×10 ⁵ (10mA 24V DC (resistive) (at 20 times/min.)) | |
| Conditions | Conditions for operation, transport and storage* | Ambient temperature: -40 to +70°C -40 to +158°F Humidity: 5 to 85% R.H. (Not freezing and condensing at low temperature) | |
| Unit weight | | Approx. 5 g .18 oz | |

Notes: * The upper operation ambient temperature limit is the maximum temperature that can satisfy the coil temperature rise value. Refer to [6] AMBIENT ENVIRONMENT in GENERAL APPLICATION GUIDELINES.

REFERENCE DATA

1-(1). High frequency characteristics (Impedance 50Ω) (Standard PC board terminal)

- V.S.W.R. characteristics

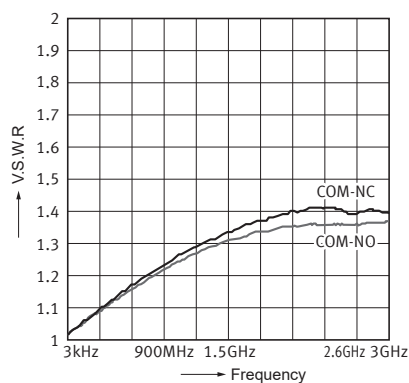

- Insertion loss characteristics



- Isolation characteristics



1-(2). High frequency characteristics (Impedance 75Ω) (Standard PC board terminal)

- V.S.W.R. characteristics

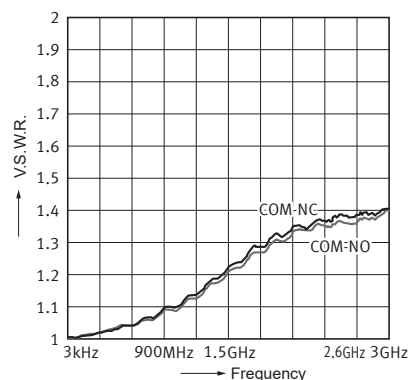

- Insertion loss characteristics

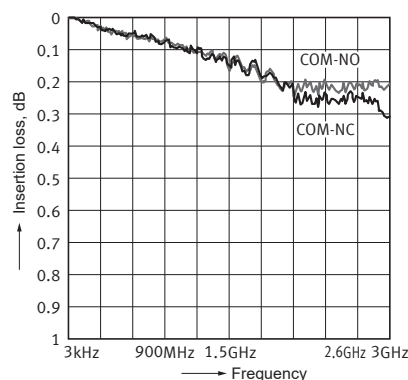

- Isolation characteristics

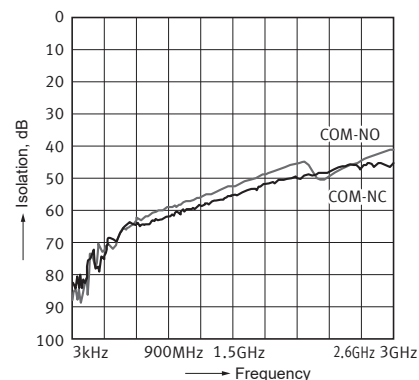

DIMENSIONS (mm inch)

The CAD data of the products with a **CAD Data** mark can be downloaded from <https://industrial.panasonic.com/ac/e/>

1. Standard PC board terminal (50Ω, 75Ω type)

CAD Data



Tolerance: $\pm 0.3 \pm 0.12$

Schematic (Bottom view)

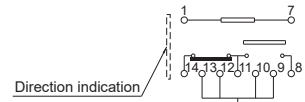

(Deenergized condition)

PC board pattern



Tolerance: $\pm 0.1 \pm 0.04$

2. Surface mount terminal • 50Ω type

CAD Data

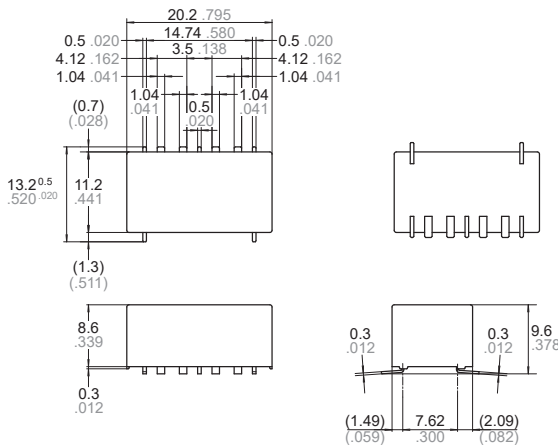

Tolerance: $\pm 0.3 \pm 0.12$

Schematic (Top view)

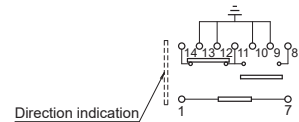

(Deenergized condition)

PC board pattern

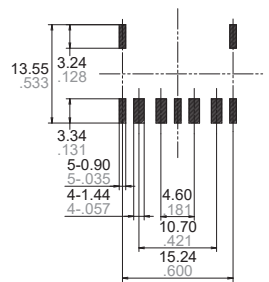

Tolerance: $\pm 0.1 \pm 0.04$

• 75Ω type

CAD Data



Tolerance: $\pm 0.3 \pm 0.12$

Schematic (Top view)

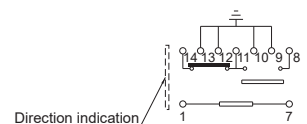

(Deenergized condition)

PC board pattern

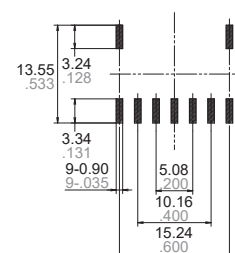

Tolerance: $\pm 0.1 \pm 0.04$

NOTES

1. Coil operating power

Pure DC current should be applied to the coil. The wave form should be rectangular. If it includes ripple, the ripple factor should be less than 5%.

However, check it with the actual circuit since the characteristics may be slightly different.

2. Cleaning

For automatic cleaning, the boiling method is recommended. Avoid ultrasonic cleaning which subjects the relays to high frequency vibrations, which may cause the contacts to stick. It is recommended that alcoholic solvents be used.

3. Soldering

(Standard PC board terminal)

1) The manual soldering shall be performed under following condition.

Max. 260°C 500°F 10s

Max. 350°C 662°F 3s

The affect of the PCB on the relay will differ depending on the type of PCB used. Please verify the type of PCB to be used. Preheat according to the following conditions.

| | |
|-------------|---------------------|
| Temperature | 120°C 248°F or less |
| Time | Within 2 minute |

Soldering should be done at 260±5°C 500±9°F within 6 s.

2) In case of automatic soldering, the following conditions should be observed (Surface-mount terminal)

(1) Position of measuring temperature



A: Surface of PC board where relay is mounted.

(2) IR (infrared reflow) soldering method



Temperature rise of relay itself may vary according to the mounting level or the heating method of reflow equipment. Therefore, please set the temperature of soldering portion of relay terminal and the top surface of the relay case not to exceed the above mentioned soldering condition.

It is recommended to check the temperature rise of each portion under actual mounting condition before use.

4. Packing style

1) Tape dimensions



2) Dimensions of plastic reel



5. Conditions for operation, transport and storage conditions

1) Ambient temperature, humidity, and atmospheric pressure during usage, transport, and storage of the relay:

(1) Temperature:

−40 to +70°C −40 to +158°F

(2) Humidity: 5 to 85% RH

(Avoid freezing and condensation.)

The humidity range varies with the temperature. Use within the range indicated in the graph below.

(3) Atmospheric pressure: 86 to 106 kPa Temperature and humidity range for usage, transport, and storage:



2) Condensation

Condensation forms when there is a sudden change in temperature under high temperature and high humidity conditions. Condensation will cause deterioration of the relay insulation.

3) Freezing

Condensation or other moisture may freeze on the relay when the temperature is lower than 0°C 32°F. This causes problems such as sticking of movable parts or operational time lags.

4) Low temperature, low humidity environments

The plastic becomes brittle if the relay is exposed to a low temperature, low humidity environment for long periods of time.

6. Measuring method

1) 50Ω type



Connect connectors 1 and 2 respectively to PORT1 and PORT2. Perform calibration using the 3.5 mm .138 inch calibration kit (50Ω).

| No. | Part number | Description |
|-----|-------------|---|
| 1 | HP 11857D | 7mm .276inch Test port, Extension cable. (APC7 connector) |
| 2 | HP 11533A | Adapter APC7-SMA (Male) |

After calibration, connect the D.U.T board and measure.

D.U.T board

Dimension (mm inch)



Material: Glass PTFE (Double sided, Through hole)
R-4737 (Panasonic Corporation)

Thickness: $t = 0.8\text{mm}$.031inch
Copper thickness: 18μm

Connector (SMA)

Product name: R125 510 (RADIALL)

2) 75Ω type



Connect connectors 1 and 2 respectively to PORT1 and PORT2. Perform calibration using the 3.5 mm .138 inch calibration kit (70Ω).

| No. | Part number | Description |
|-----|-------------|-------------------------------------|
| 1 | HP 11857B | 75ΩF Test port, Return cable |
| 2 | 85039-60011 | Adapter 75ΩN (Female) – 75ΩF (Male) |

After calibration, connect the D.U.T board and measure.

D.U.T board

Dimension (mm inch)

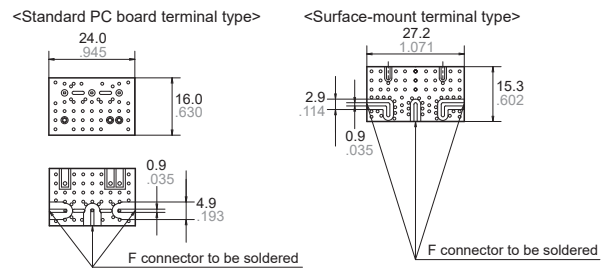

Material: Glass PTFE (Double sided, Through hole)
R-4737 (Panasonic Corporation)

Thickness: $t = 0.8\text{mm}$.031inch
Copper thickness: 18μm

Connector (F)

Product name: C05-0236 (KOMINE MUSEN DENKI)

Please refer to **"the latest product specifications"** when designing your product.

• Requests to customers :

<https://industrial.panasonic.com/ac/e/salespolicies/>

GUIDELINES FOR MICROWAVE DEVICES USAGE

For cautions for use, please read "GUIDELINES FOR RELAY USAGE".

https://industrial.panasonic.com/ac/e/control/relay/cautions_use/index.jsp

Precautions for Coil Input

■ Long term current carrying

A circuit that will be carrying a current continuously for long periods without relay or microwave device switching operation. (circuits for emergency lamps, alarm devices and error inspection that, for example, revert only during malfunction and output warnings with form B contacts) Continuous, long-term current to the coil will facilitate deterioration of coil insulation and characteristics due to heating of the coil itself.

For circuits such as these, please use a magnetic-hold type latching relay. If you need to use a single stable relay, use a sealed type relay that is not easily affected by ambient conditions and make a failsafe circuit design that considers the possibility of contact failure or disconnection.

■ DC Coil operating power

Steady state DC current should be applied to the coil. The wave form should be rectangular. If it includes ripple, the ripple factor should be less than 5%.

However, please check with the actual circuit since the electrical characteristics may vary. The rated coil voltage should be applied to the coil and the set/reset pulse time of latching type relay differs for each relays, please refer to the relay's individual specifications.

■ Coil connection

When connecting coils of polarized relays, please check coil polarity (+,-) at the internal connection diagram (Schematic). If any wrong connection is made, it may cause unexpected malfunction, like abnormal heat, fire and so on, and circuit do not work. Avoid impressing voltages to the set coil and reset coil at the same time.

■ Maximum allowable voltage and temperature rise

Proper usage requires that the rated coil voltage be impressed on the coil. Note, however, that if a voltage greater than or equal to the maximum continuous voltage is impressed on the coil, the coil may burn or its layers short due to the temperature rise. Furthermore, do not exceed the usable ambient temperature range listed in the catalog.

● Maximum allowable voltage for coil

In addition to being a requirement for relay operation stability, the maximum continuous impressed coil voltage is an important constraint for the prevention of such problems as thermal deterioration or deformity of the insulation material, or the occurrence of fire hazards.

Ambient Environment

● Dew condensation

Condensation occurs when the ambient temperature drops suddenly from a high temperature and humidity, or the relay and microwave device is suddenly transferred from a low ambient temperature to a high temperature and humidity. Condensation causes the failures like insulation deterioration, wire disconnection and rust etc.

Panasonic Corporation does not guarantee the failures caused by condensation.

The heat conduction by the equipment may accelerate the cooling of device itself, and the condensation may occur. Please conduct product evaluations in the worst condition of the actual usage. (Special attention should be paid when high temperature heating parts are close to the device. Also please consider the condensation may occur inside of the device.)

● Icing

Condensation or other moisture may freeze on relays when the temperature become lower than 0°C. This icing causes the sticking of movable portion, the operation delay and the contact conduction failure etc. Panasonic Corporation does not guarantee the failures caused by the icing.

● Temperature rise due to pulse voltage

When a pulse voltage with ON time of less than 2 minutes is used, the coil temperature rise bears no relationship to the ON time. This varies with the ratio of ON time to OFF time, and compared with continuous current passage, it is rather small. The various relays are essentially the same in this respect.

| Current passage time | (%) |
|------------------------|--------------------------------|
| For continuous passage | Temperature rise value is 100% |
| ON : OFF = 3 : 1 | About 80% |
| ON : OFF = 1 : 1 | About 50% |
| ON : OFF = 1 : 3 | About 35% |

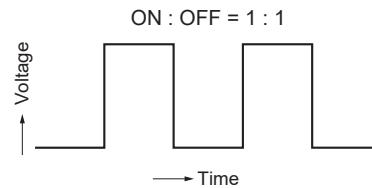

■ Operate voltage change due to coil temperature rise (Hot start)

In DC relays, after continuous passage of current in the coil, if the current is turned OFF, then immediately turned ON again, due to the temperature rise in the coil, the pick-up voltage will become somewhat higher. Also, it will be the same as using it in a higher temperature atmosphere. The resistance/temperature relationship for copper wire is about 0.4% for 1°C, and with this ratio the coil resistance increases. That is, in order to operate of the relay, it is necessary that the voltage be higher than the pick-up voltage and the pick-up voltage rises in accordance with the increase in the resistance value. However, for some polarized relays, this rate of change is considerably smaller.

The heat conduction by the equipment may accelerate the cooling of relay itself and the icing may occur. Please conduct product evaluations in the worst condition of the actual usage.

● Low temperature and low humidity

The plastic becomes brittle if the switch is exposed to a low temperature, low humidity environment for long periods of time.

● High temperature and high humidity

Storage for extended periods of time (including transportation periods) at high temperature or high humidity levels or in atmospheres with organic gases or sulfide gases may cause a sulfide film or oxide film to form on the surfaces of the contacts and/or it may interfere with the functions. Check out the atmosphere in which the units are to be stored and transported.

● Package

In terms of the packing format used, make every effort to keep the effects of moisture, organic gases and sulfide gases to the absolute minimum.

GUIDELINES FOR MICROWAVE DEVICES USAGE

●Storage requirements

Since the SMD type is sensitive to humidity it is packaged with tightly sealed anti-humidity packaging. However, when storing, please be careful of the following.

- 1) Please use promptly once the anti-humidity pack is opened. (Signal relay: within 3 days, Max. 30°C/70%RH). If left with the pack open, the relay will absorb moisture which will cause thermal stress when reflow mounting and thus cause the case to expand. As a result, the seal may break.
 - 2) When storing for a long period after opening the anti-humidity pack, you must take measures to prevent humidity, for example, by storing in the open location of a promptly re-sealed anti-humidity pack after it is used or in a humidity controlled desiccator. You may also store it in an anti-humidity bag to which silica gel has been added.
- *If the relay is to be soldered after it has been exposed to excessive humidity atmosphere, cracks and leaks can occur. Be sure to mount the relay under the required mounting conditions
- 3) The following cautionary label is affixed to the anti-humidity pack.

C a u t i o n

This vacuum-sealed bag contains

Moisture Sensitive Products

After this bag is opened, the product must be used

within 7 2 h o u r s

If product is not used within 72 hours, baking is necessary.

For baking conditions please contact us.

●Silicon

When a source of silicone substances (silicone rubber, silicone oil, silicone coating materials and silicone filling materials etc.) is used around the relay, the silicone gas (low molecular siloxane etc.) may be produced.

This silicone gas may penetrate into the inside of the relay. When the relay is kept and used in this condition, silicone compound may adhere to the relay contacts which may cause the contact failure. Do not use any sources of silicone gas around the relay (Including plastic seal types).

●NOx Generation

When relay is used in an atmosphere high in humidity to switch a load which easily produces an arc, the NOx created by the arc and the water absorbed from outside the relay combine to produce nitric acid. This corrodes the internal metal parts and adversely affects operation. Avoid use at an ambient humidity of 85%RH or higher (at 20°C). If use at high humidity is unavoidable, please contact our sales representative.

Others

■Cleaning

- 1) Although the environmentally sealed type relay (plastic sealed type, etc.) can be cleaned, avoid immersing the relay into cold liquid (such as cleaning solvent) immediately after soldering. Doing so may deteriorate the sealing performance.
- 2) Surface mount terminal type relay is sealed type and it can be cleaned by immersion. Use pure water or alcohol-based cleaning solvent.
- 3) Cleaning with the boiling method is recommended (The temperature of cleaning liquid should be 40°C or lower).
Avoid ultrasonic cleaning on relays. Use of ultrasonic cleaning may cause breaks in the coil or slight sticking of the contacts due to the ultrasonic energy

■Other handling precautions.

- Expected switching life is defined under the standard test conditions (temperature 15 to 35°C, humidity: 25 to 75%) specified in JIS C 5442.
Expected switching life is depend on usage conditions; coil driving circuit, load type, activation frequency, activation phase, ambient conditions and other factors. Please check relays and microwave devices on the actual circuit.
Also, pay special attention loads such as those listed below.
- When used for AC load-operating and the operating phase is synchronous, rocking and fusing can easily occur due to contact shifting.

- Frequent switching under load condition When high frequently switched under load condition that can cause arc at the contacts, nitrogen and oxygen in the air is fused by the arc energy and HNO₃ is formed. This can corrode metal materials. Countermeasures for these are.
 1. Incorporate an arc-extinguishing circuit.
 2. Lower the operating frequency
 3. Lower the ambient humidity
- When used for "Dry switching" without load current, please contact our sales representative.
- Please avoid relays to be used outside of the specification ranges such as the coil rating, contact rating and switching life that may cause abnormal heating, smoke, and fire.
- In case relays and microwave devices are dropped, please do not use.

Please refer to "**the latest product specifications**" when designing your product.

•Requests to customers:

<https://industrial.panasonic.com/ac/e/salespolicies/>

Please contact

Panasonic Corporation

Electromechanical Control Business Division

■ 1006, Oaza Kadoma, Kadoma-shi, Osaka 571-8506, Japan
industrial.panasonic.com/ac/e/

Panasonic[®]

©Panasonic Corporation 2019

Mouser Electronics

Authorized Distributor

Click to View Pricing, Inventory, Delivery & Lifecycle Information:

Panasonic:

[ARE13A4HZC90](#) [ARE13A4HC90](#) [ARE13A03ZC90](#) [ARE1003C90](#) [ARE1006C90](#) [ARE1009C90](#) [ARE1012C90](#)
[ARE1024C90](#) [ARE104HC90](#) [ARE13A12ZC90](#) [ARE13A24C90](#) [ARE13A24ZC90](#) [ARE13A03C90](#) [ARE13A06C90](#)
[ARE13A06ZC90](#) [ARE13A09C90](#) [ARE13A09ZC90](#) [ARE13A12C90](#) [ARE1303C90](#) [ARE1306C90](#) [ARE1309C90](#)
[ARE1312C90](#) [ARE1324C90](#) [ARE134HC90](#) [ARE10A12C90](#) [ARE10A12ZC90](#) [ARE10A24C90](#) [ARE10A24ZC90](#)
[ARE10A4HC90](#) [ARE10A4HZC90](#) [ARE10A03C90](#) [ARE10A03ZC90](#) [ARE10A06C90](#) [ARE10A06ZC90](#) [ARE10A09C90](#)
[ARE10A09ZC90](#)

Компания «Life Electronics» занимается поставками электронных компонентов импортного и отечественного производства от производителей и со складов крупных дистрибьюторов Европы, Америки и Азии.

С конца 2013 года компания активно расширяет линейку поставок компонентов по направлению коаксиальный кабель, кварцевые генераторы и конденсаторы (керамические, пленочные, электролитические), за счёт заключения дистрибьюторских договоров

Мы предлагаем:

- Конкурентоспособные цены и скидки постоянным клиентам.
- Специальные условия для постоянных клиентов.
- Подбор аналогов.
- Поставку компонентов в любых объемах, удовлетворяющих вашим потребностям.
- Приемлемые сроки поставки, возможна ускоренная поставка.
- Доставку товара в любую точку России и стран СНГ.
- Комплексную поставку.
- Работу по проектам и поставку образцов.
- Формирование склада под заказчика.
- Сертификаты соответствия на поставляемую продукцию (по желанию клиента).
- Тестирование поставляемой продукции.
- Поставку компонентов, требующих военную и космическую приемку.
- Входной контроль качества.
- Наличие сертификата ISO.

В составе нашей компании организован Конструкторский отдел, призванный помогать разработчикам, и инженерам.

Конструкторский отдел помогает осуществить:

- Регистрацию проекта у производителя компонентов.
- Техническую поддержку проекта.
- Защиту от снятия компонента с производства.
- Оценку стоимости проекта по компонентам.
- Изготовление тестовой платы монтаж и пусконаладочные работы.



Тел: +7 (812) 336 43 04 (многоканальный)
Email: org@lifeelectronics.ru