

## HDSM-281x/283x

### 0.28 in. (7.0 mm) Single-Digit Surface-Mount LED Display

---

#### Description

The Broadcom<sup>®</sup> HDSM-281x/283x is a single-digit display of 0.28 in. (7.0 mm) height. This device uses AlInGaP/GaAs chips and has a grey top surface with white segments.

#### Features

- 0.28 in. digit height
- Low current operation
- Excellent characters appearance
- Available in CA and CC
- 1000 pieces per reel
- Moisture sensitivity level: Level 3
- RoHS compliant

#### Ordering Information

Red	Green	Yellow	Orange	Description
HDSM-281C	HDSM-281H	HDSM-281F	HDSM-281L	Common Anode, Upper and Lower Decimal
HDSM-283C	HDSM-283H	HDSM-283F	HDSM-283L	Common Cathode, Upper and Lower Decimal

# Package Dimensions

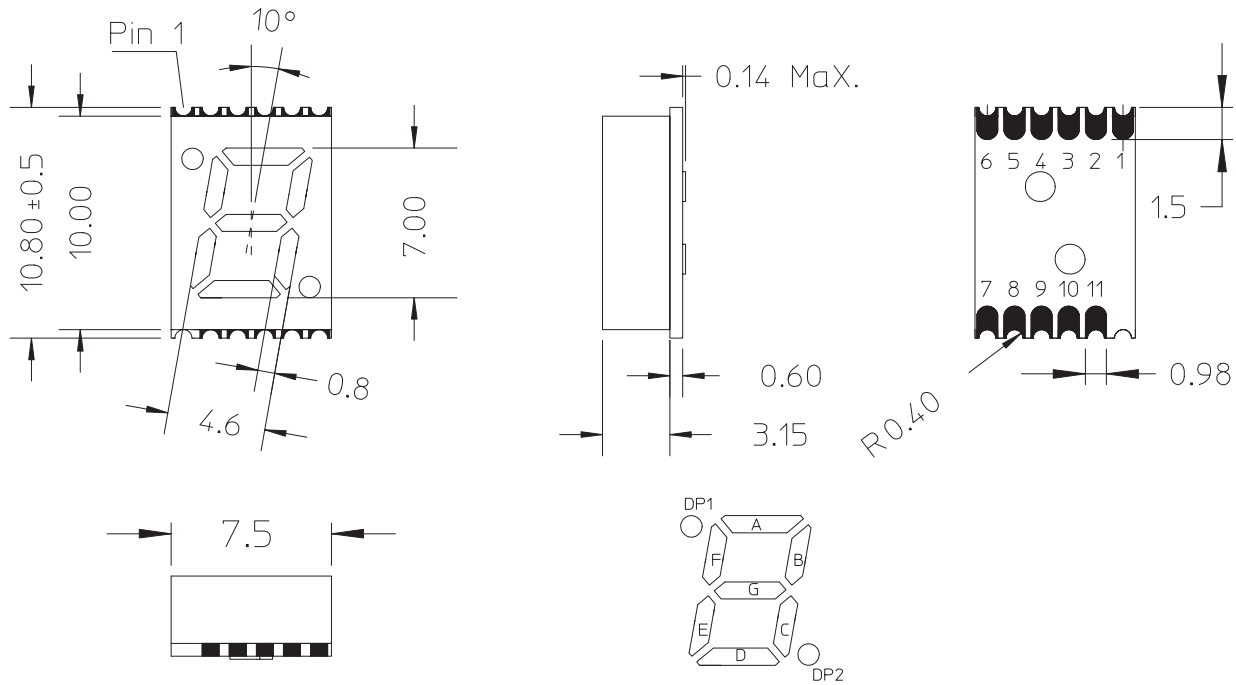

**NOTE:**

1. All dimensions are in millimeters (inches).
2. Tolerance  $\pm 0.25$  mm (0.01 in.) unless otherwise noted.

### Pin Connection (Common Anode)

Pin Number	Connection
1	CATHODE G
2	CATHODE DP1
3	CATHODE F
4	COMMON ANODE
5	CATHODE A
6	CATHODE B
7	CATHODE DP2
8	CATHODE C
9	COMMON ANODE
10	CATHODE D
11	CATHODE E

### Pin Connection (Common Cathode)

Pin Number	Connection
1	ANODE G
2	ANODE DP1
3	ANODE F
4	COMMON CATHODE
5	ANODE A
6	ANODE B
7	ANODE DP2
8	ANODE C
9	COMMON CATHODE
10	ANODE D
11	ANODE E

### Internal Circuit Diagram (Common Anode)

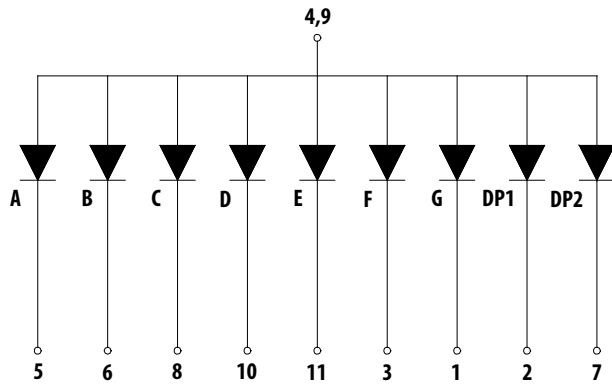

### Internal Circuit Diagram (Common Cathode)

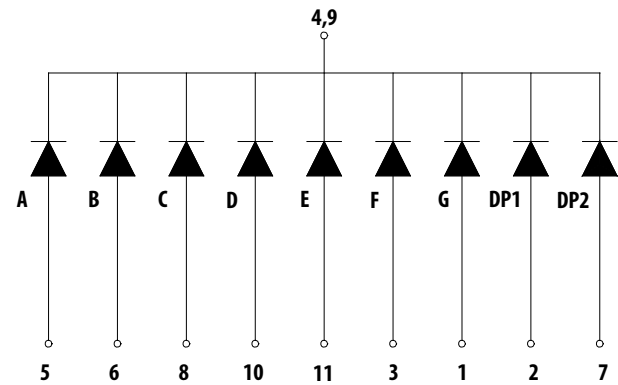

### Absolute Maximum Ratings at $T_A = 25^\circ\text{C}$

Parameter	Green/Yellow/Red/Orange	Units
Power Dissipation Per Segment	65	mW
Peak Forward Current Per Segment (1/10 Duty Cycle, 0.1-ms pulse width)	100	mA
Continuous Forward Current Per Segment	25	mA
Derating Linearly From 25°C Per Segment	0.25	mA/°C
Reverse Voltage Per Segment	5	V
Operating Temperature Range	-40°C to +105°C	
Storage Temperature Range	-40°C to +105°C	

## Electrical/Optical Characteristics at $T_A = 25^\circ\text{C}$

### Green

Parameters	Symbol	Min.	Typ.	Max.	Units	Test Condition
Average Luminous Intensity	$I_V$	3.4	6	—	mcd	$I_F = 10\text{ mA}$
Emissions Wavelength	$\lambda_p/\lambda_d$	—	572/571	—	nm	$I_F = 20\text{ mA}$
Spectral Line Half-Width	$\Delta\lambda$	—	20	—	nm	$I_F = 20\text{ mA}$
Forward Voltage, Per Segment	$V_F$	—	2.1	2.6	V	$I_F = 20\text{ mA}$
Reverse Current, Per Segment	$I_R$	—	—	100	$\mu\text{A}$	$V_R = 5\text{V}$
Luminous Intensity Matching Ratio	$I_{V-M}$	—	—	2:1		$I_F = 10\text{ mA}$

### Yellow

Parameters	Symbol	Min.	Typ.	Max.	Units	Test Condition
Average Luminous Intensity	$I_V$	3.4	8.0	—	mcd	$I_F = 10\text{ mA}$
Emissions Wavelength	$\lambda_p/\lambda_d$	—	591/589	—	nm	$I_F = 20\text{ mA}$
Spectral Line Half-Width	$\Delta\lambda$	—	15	—	nm	$I_F = 20\text{ mA}$
Forward Voltage, Per Segment	$V_F$	—	2.1	2.6	V	$I_F = 20\text{ mA}$
Reverse Current, Per Segment	$I_R$	—	—	100	$\mu\text{A}$	$V_R = 5\text{V}$
Luminous Intensity Matching Ratio	$I_{V-M}$	—	—	2:1		$I_F = 10\text{ mA}$

### Red

Parameters	Symbol	Min.	Typ.	Max.	Units	Test Condition
Average Luminous Intensity	$I_V$	3.4	7.5	—	mcd	$I_F = 10\text{ mA}$
Emissions Wavelength	$\lambda_p/\lambda_d$	—	644/630	—	nm	$I_F = 20\text{ mA}$
Spectral Line Half-Width	$\Delta\lambda$	—	20	—	nm	$I_F = 20\text{ mA}$
Forward Voltage, Per Segment	$V_F$	—	2.0	2.6	V	$I_F = 20\text{ mA}$
Reverse Current, Per Segment	$I_R$	—	—	100	$\mu\text{A}$	$V_R = 5\text{V}$
Luminous Intensity Matching Ratio	$I_{V-M}$	—	—	2:1		$I_F = 10\text{ mA}$

### Orange

Parameters	Symbol	Min.	Typ.	Max.	Units	Test Condition
Average Luminous Intensity	$I_V$	3.4	8.5	—	mcd	$I_F = 10\text{ mA}$
Emissions Wavelength	$\lambda_p/\lambda_d$	—	611/605	—	nm	$I_F = 20\text{ mA}$
Spectral Line Half-Width	$\Delta\lambda$	—	20	—	nm	$I_F = 20\text{ mA}$
Forward Voltage, Per Segment	$V_F$	—	2.1	2.6	V	$I_F = 20\text{ mA}$
Reverse Current, Per Segment	$I_R$	—	—	100	$\mu\text{A}$	$V_R = 5\text{V}$
Luminous Intensity Matching Ratio	$I_{V-M}$	—	—	2:1		$I_F = 10\text{ mA}$

# Typical Electrical/Optical Characteristic Curves at $T_A = 25^\circ\text{C}$

## Green

Figure 1: Relative Luminous Intensity vs. Wavelength

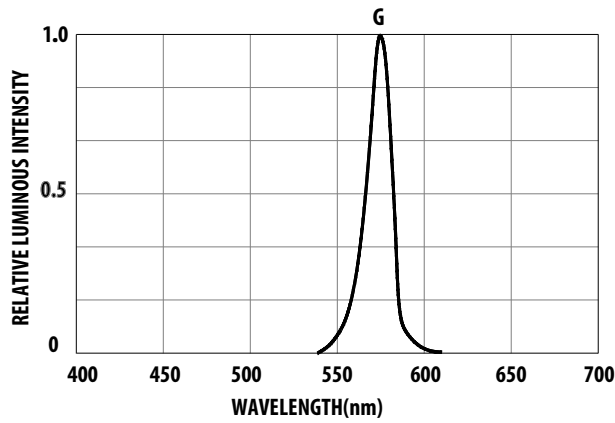

Figure 2: Relative Luminous Intensity vs. Forward Current

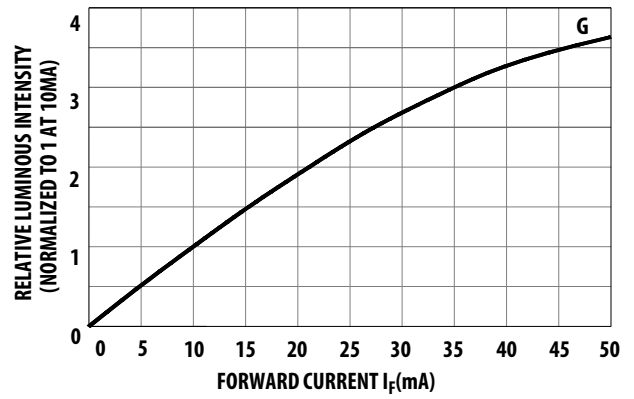

Figure 3: Allowable DC Current vs. Ambient Temperature

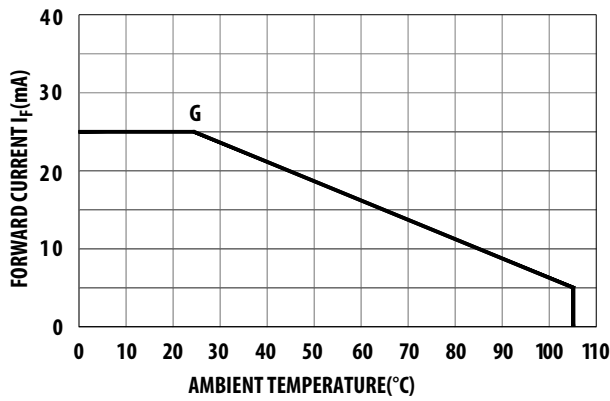
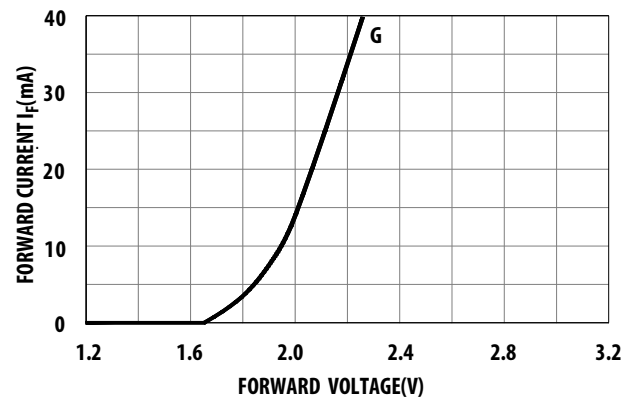

Figure 4: Forward Current vs. Forward Voltage



# Typical Electrical/Optical Characteristic Curves at $T_A = 25^\circ\text{C}$

## Yellow

Figure 5: Relative Intensity vs. Wavelength

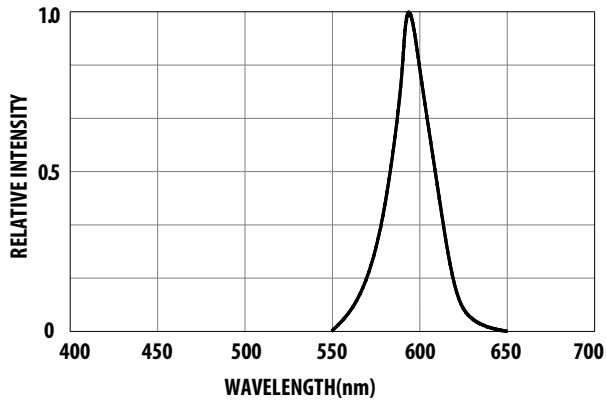

Figure 6: Relative Intensity vs. Forward Current

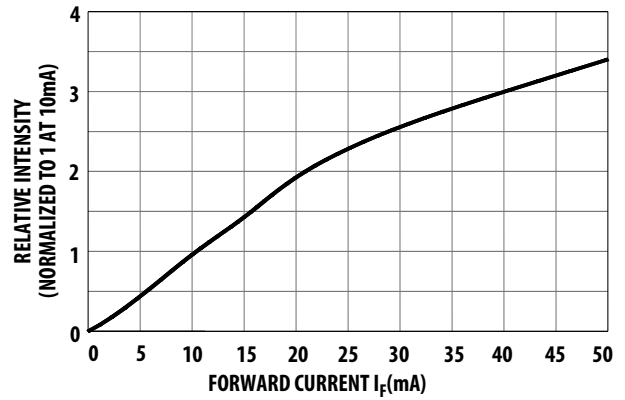

Figure 7: Allowable DC Current vs. Ambient Temperature

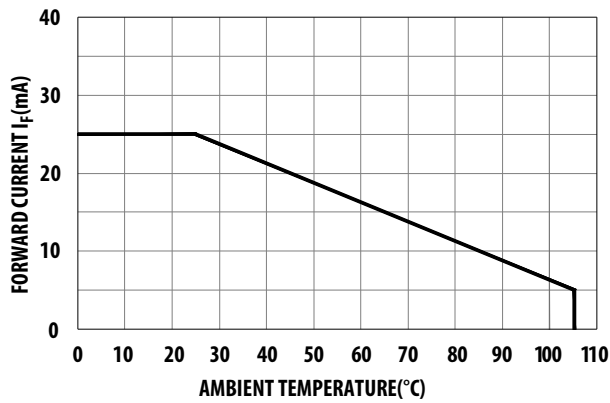
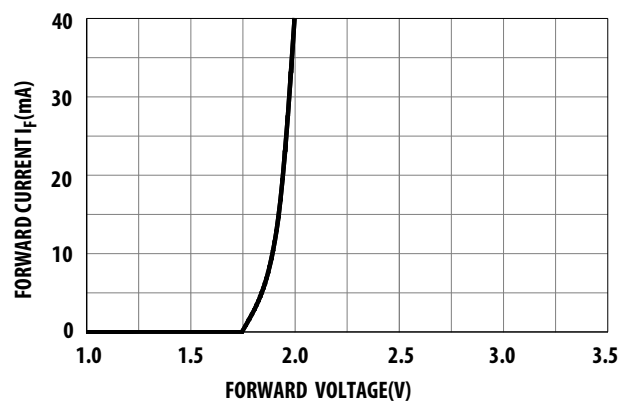

Figure 8: Forward Current vs. Forward Voltage



# Typical Electrical/Optical Characteristic Curves at $T_A = 25^\circ\text{C}$

## Red

Figure 9: Relative Intensity vs. Wavelength

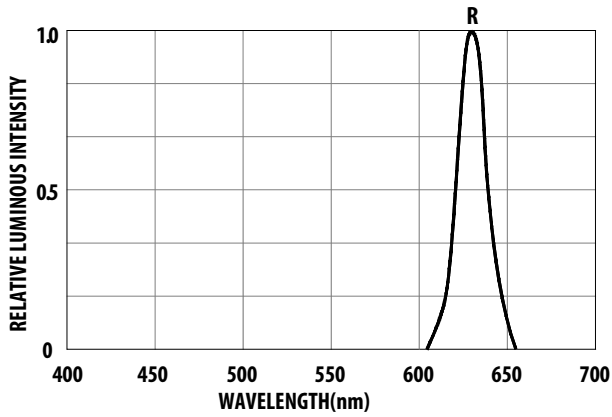

Figure 10: Relative Luminous Intensity vs. Forward Current

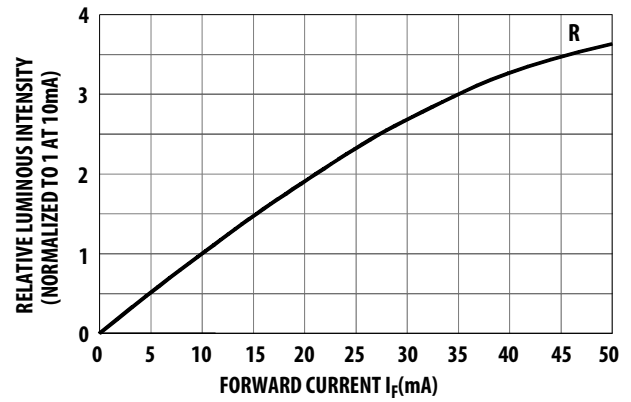

Figure 11: Allowable DC Current vs. Ambient Temperature

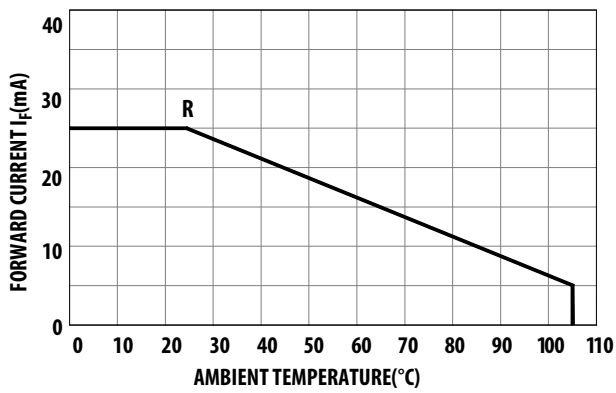
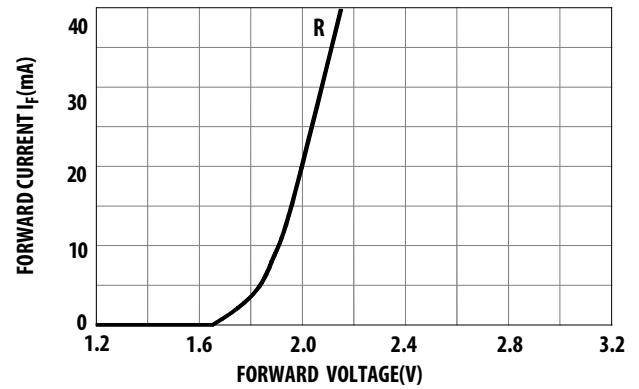

Figure 12: Forward Current vs. Forward Voltage



# Typical Electrical/Optical Characteristic Curves at $T_A = 25^\circ\text{C}$

## Orange

Figure 13: Relative Intensity vs. Wavelength

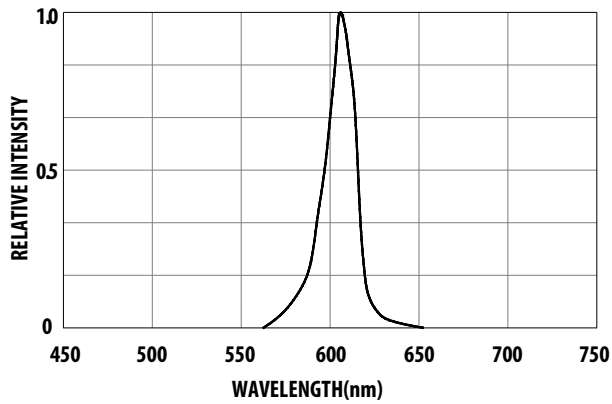

Figure 14: Relative Intensity vs. Forward Current

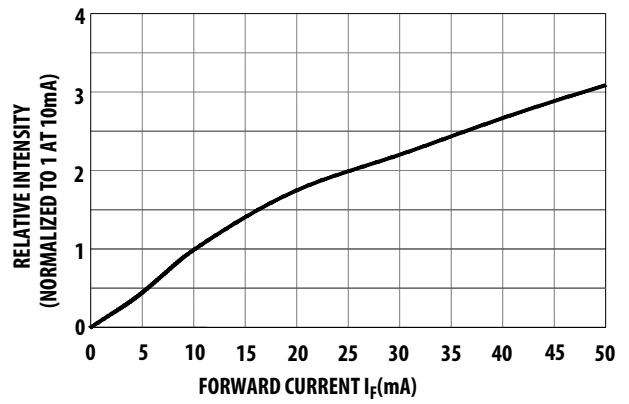

Figure 15: Allowable DC Current vs. Ambient Temperature

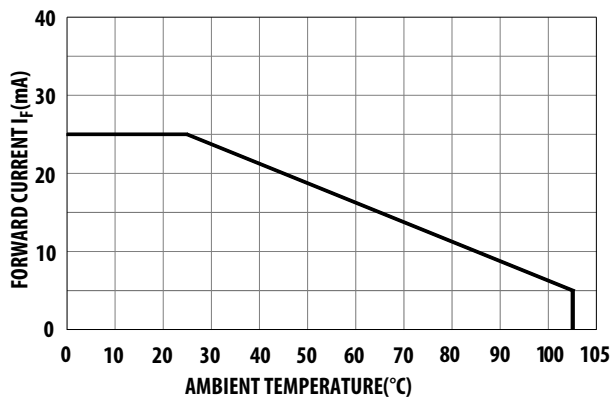
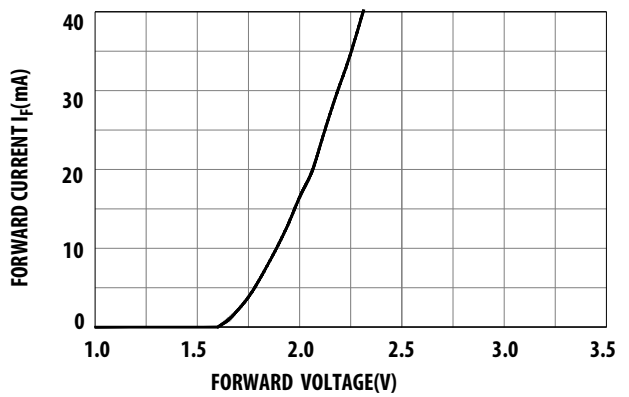

Figure 16: Forward Current vs. Forward Voltage





# Intensity Bin Limits (mcd)

## Yellow/Red/Orange/Green

IV Bin Category	Min.	Max.
L	3.401	5.400
M	5.401	8.600
N	8.601	13.700
P	13.701	21.800

Tolerance: ± 15%.

**NOTE:** Bin categories are established for classification of products. Products may not be available in all categories. Contact your Broadcom representative for information on currently available bins.

## SMT Soldering Profile

### Pb-Free Reflow Soldering Profile

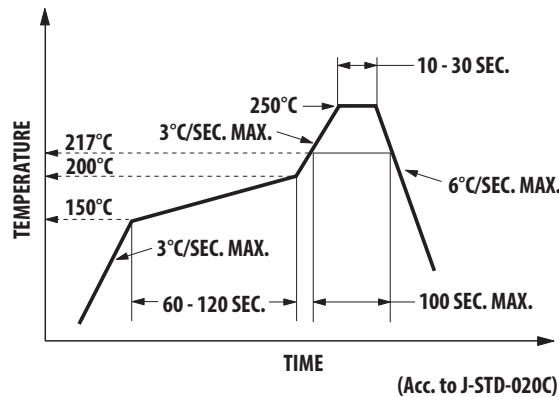

**NOTE:**

1. The peak temperature refers to the peak package body temperature.
2. The number of reflow processes shall be limited to a maximum of twice only. A cooling process to normal temperature is required between the first and second soldering processes.

### Recommended Soldering Pattern (Unit: mm)

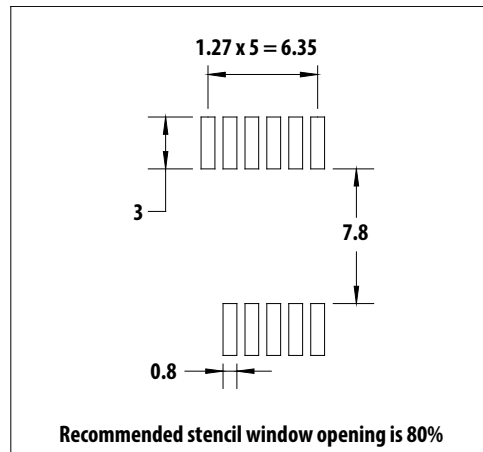

# Tape Specification (Unit: mm)

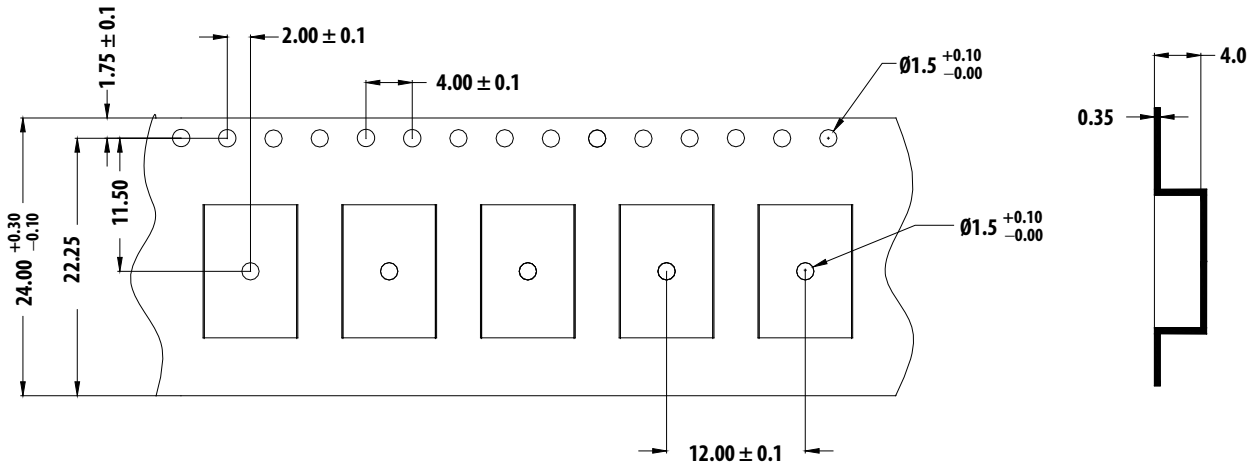

Broadcom, the pulse logo, Connecting everything, Avago Technologies, Avago, and the A logo are among the trademarks of Broadcom and/or its affiliates in the United States, certain other countries, and/or the EU.

Copyright © 2011–2018 Broadcom. All Rights Reserved.

The term “Broadcom” refers to Broadcom Inc. and/or its subsidiaries. For more information, please visit [www.broadcom.com](http://www.broadcom.com).

Broadcom reserves the right to make changes without further notice to any products or data herein to improve reliability, function, or design. Information furnished by Broadcom is believed to be accurate and reliable. However, Broadcom does not assume any liability arising out of the application or use of this information, nor the application or use of any product or circuit described herein, neither does it convey any license under its patent rights nor the rights of others.



Компания «Life Electronics» занимается поставками электронных компонентов импортного и отечественного производства от производителей и со складов крупных дистрибьюторов Европы, Америки и Азии.

С конца 2013 года компания активно расширяет линейку поставок компонентов по направлению коаксиальный кабель, кварцевые генераторы и конденсаторы (керамические, пленочные, электролитические), за счёт заключения дистрибьюторских договоров

Мы предлагаем:

- Конкурентоспособные цены и скидки постоянным клиентам.
- Специальные условия для постоянных клиентов.
- Подбор аналогов.
- Поставку компонентов в любых объемах, удовлетворяющих вашим потребностям.
- Приемлемые сроки поставки, возможна ускоренная поставка.
- Доставку товара в любую точку России и стран СНГ.
- Комплексную поставку.
- Работу по проектам и поставку образцов.
- Формирование склада под заказчика.
- Сертификаты соответствия на поставляемую продукцию (по желанию клиента).
- Тестирование поставляемой продукции.
- Поставку компонентов, требующих военную и космическую приемку.
- Входной контроль качества.
- Наличие сертификата ISO.

В составе нашей компании организован Конструкторский отдел, призванный помогать разработчикам, и инженерам.

Конструкторский отдел помогает осуществить:

- Регистрацию проекта у производителя компонентов.
- Техническую поддержку проекта.
- Защиту от снятия компонента с производства.
- Оценку стоимости проекта по компонентам.
- Изготовление тестовой платы монтаж и пусконаладочные работы.



Тел: +7 (812) 336 43 04 (многоканальный)

Email: [org@lifeelectronics.ru](mailto:org@lifeelectronics.ru)