

HEIDI-W2

~45° wide beam

TECHNICAL SPECIFICATIONS:

Dimensions	Ø 21.6 mm
Height	12 mm
Fastening	tape, pin
ROHS compliant	yes ⓘ

MATERIAL SPECIFICATIONS:

Component	Type	Material	Colour	Finish
HEIDI-W2	Single lens	PMMA	clear	
HEIDI-TAPE	Tape	PU tape	black	



ORDERING INFORMATION:

Component		Qty in box	MOQ	MPQ	Box weight (kg)
CA12079_HEIDI-W2	Single lens	3264	204	204	11.1
» Box size: 480 x 280 x 300 mm					

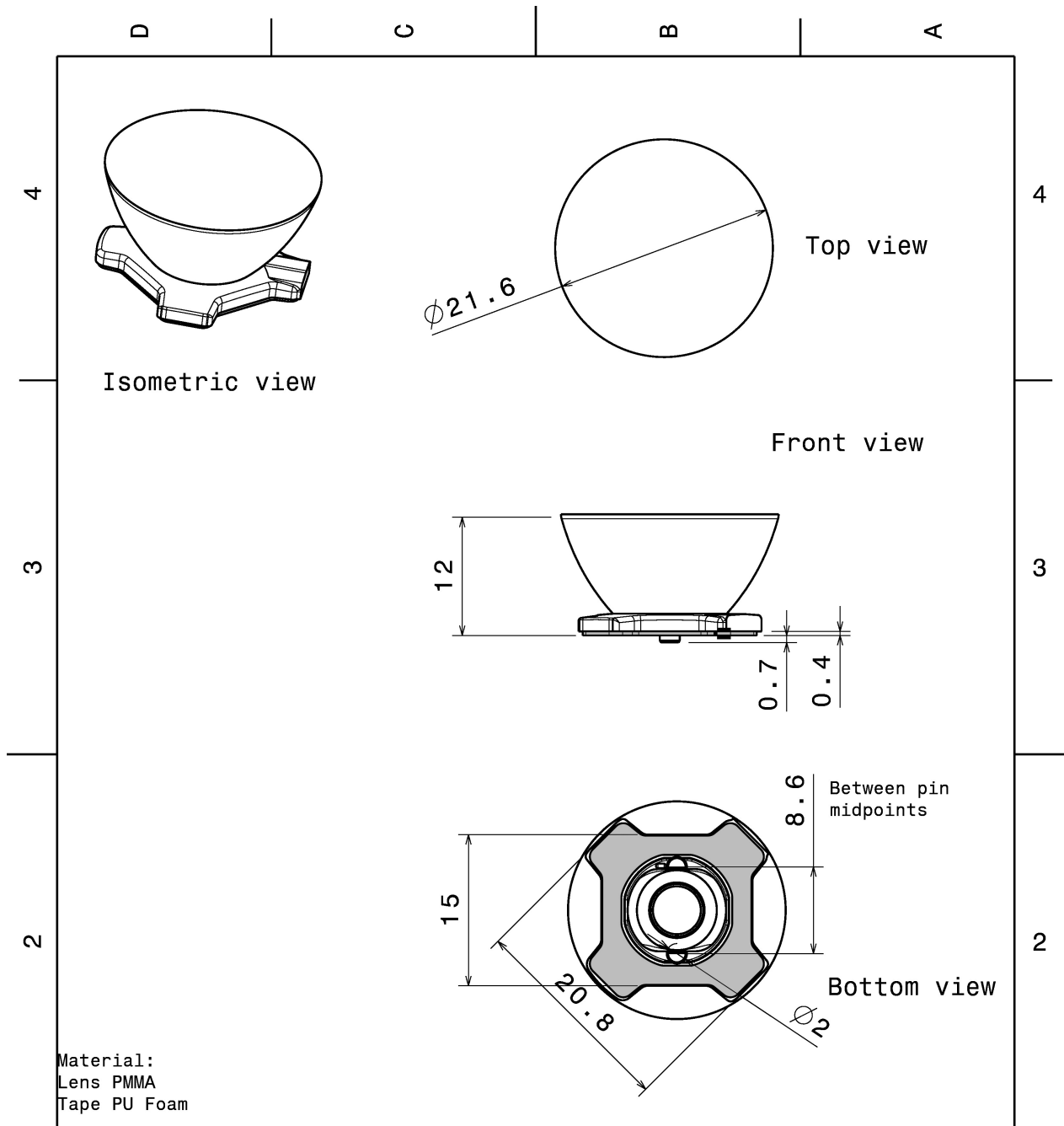

Material:
Lens PMMA
Tape PU Foam

Tolerances if not otherwise shown
According to DIN ISO 2768-1
Linear measures:
Up to 30mm class F, otherwise class M.
According to DIN ISO 2768-2
Form and position: class K

LEDiL Ledil Oy
Joensuunkatu 13
FIN 24100 SALO
Finland

THIRD ANGLE PROJECTION:

DRAWING TITLE
Datasheet_Heidi-W2

This drawing is the property of LEDiL Oy. It may not be reproduced, copied or communicated without a written agreement with LEDiL Oy."

SIZE	PART NUMBER
A4	

SCALE	1:1	WEIGHT	(g)	SHEET	1/1
-------	-----	--------	-----	-------	-----

PHOTOMETRIC DATA (MEASURED):

CREE 

LED XB-D
FWHM 46.0°
Efficiency 76 %
Peak intensity 1 cd/lm
LEDs/each optic 1
Light colour White
Required components:

CREE 

LED XB-H
FWHM 45.0°
Efficiency 80 %
Peak intensity 1.2 cd/lm
LEDs/each optic 1
Light colour White
Required components:

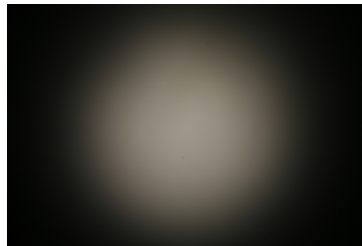

CREE 

LED XHP35 HD
FWHM 46.0°
Efficiency 81 %
Peak intensity 1.3 cd/lm
LEDs/each optic 1
Light colour White
Required components:

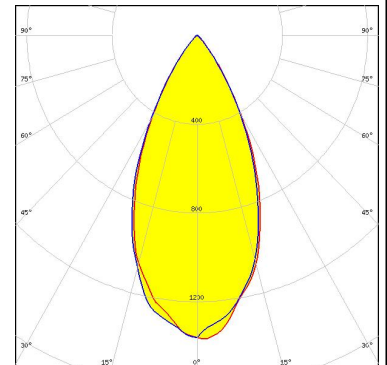
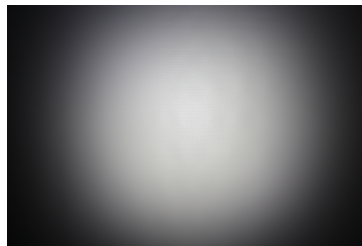

CREE 

LED XHP35 HI
FWHM 44.0°
Efficiency 91 %
Peak intensity 1.4 cd/lm
LEDs/each optic 1
Light colour White
Required components:

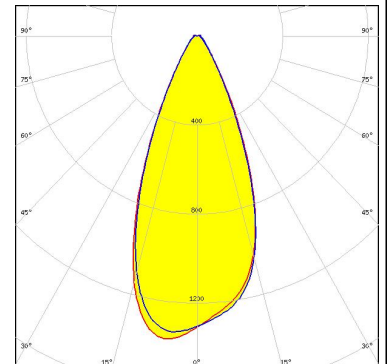
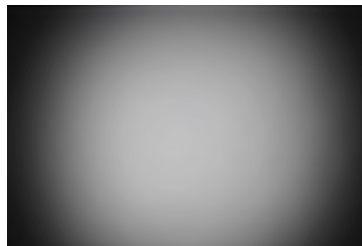

PHOTOMETRIC DATA (MEASURED):

CREE

LED XP-E
FWHM 44.0°
Efficiency 81 %
Peak intensity 1.1 cd/lm
LEDs/each optic 1
Light colour White
Required components:

CREE

LED XP-E2
FWHM 45.0°
Efficiency 81 %
Peak intensity 1.4 cd/lm
LEDs/each optic 1
Light colour White
Required components:

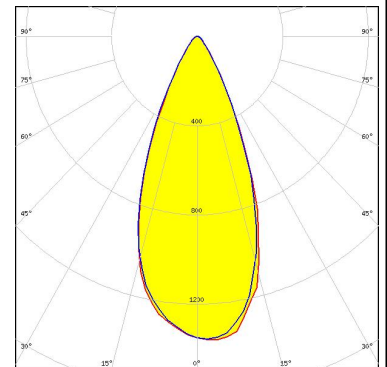
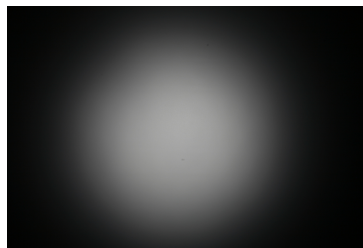

CREE

LED XP-G
FWHM 44.0°
Efficiency 81 %
Peak intensity 1.1 cd/lm
LEDs/each optic 1
Light colour White
Required components:

CREE

LED XP-G2
FWHM 46.0°
Efficiency 80 %
Peak intensity 1.3 cd/lm
LEDs/each optic 1
Light colour White
Required components:

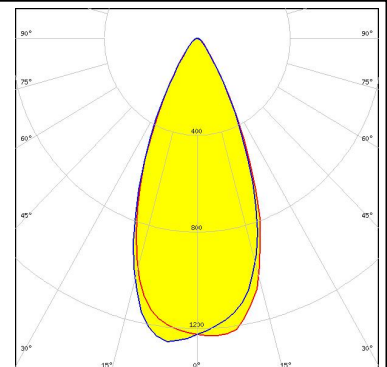
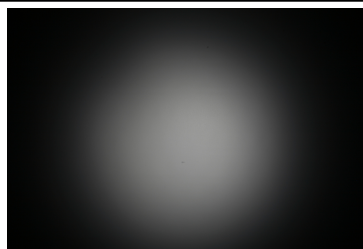

PHOTOMETRIC DATA (MEASURED):

CREE 

LED XP-G3
FWHM 42.0°
Efficiency 91 %
Peak intensity 1.3 cd/lm
LEDs/each optic 1
Light colour White
Required components:

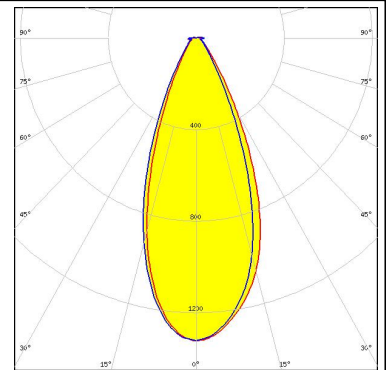

CREE 

LED XP-L HD
FWHM 44.0°
Efficiency 79 %
Peak intensity 1.3 cd/lm
LEDs/each optic 1
Light colour White
Required components:

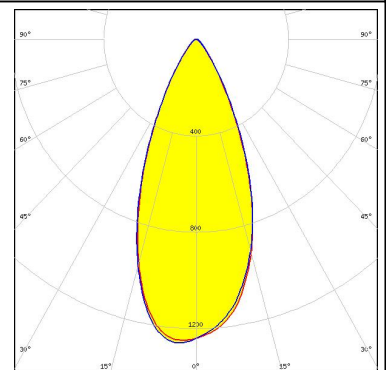
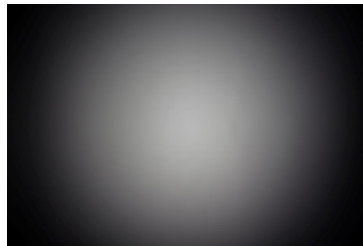

CREE 

LED XQ-E HD
FWHM 44.0°
Efficiency 91 %
Peak intensity 1.4 cd/lm
LEDs/each optic 1
Light colour White
Required components:

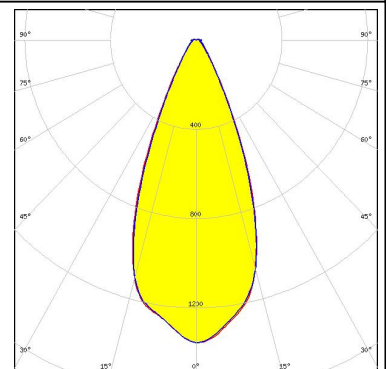
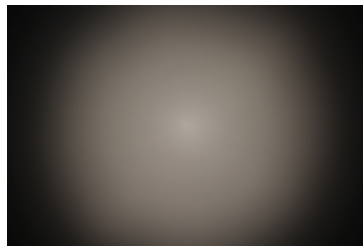

CREE 

LED XQ-E HI
FWHM 42.0°
Efficiency 87 %
Peak intensity 1.3 cd/lm
LEDs/each optic 1
Light colour White
Required components:

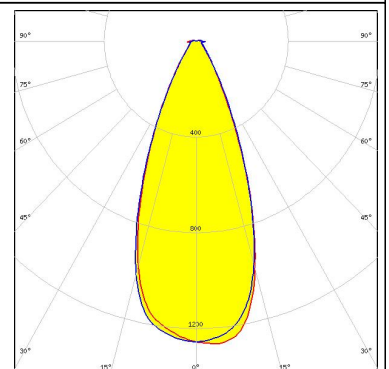
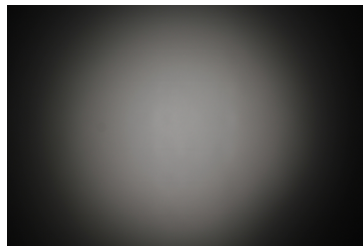

PHOTOMETRIC DATA (MEASURED):



LED XT-E
 FWHM 42.0°
 Efficiency 75 %
 Peak intensity 1.3 cd/lm
 LEDs/each optic 1
 Light colour White
 Required components:

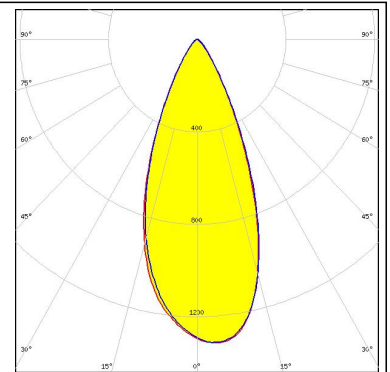
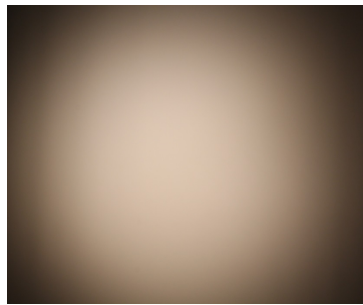

LED LUXEON C
 FWHM 40.0°
 Efficiency 71 %
 Peak intensity 1.4 cd/lm
 LEDs/each optic 1
 Light colour White
 Required components:

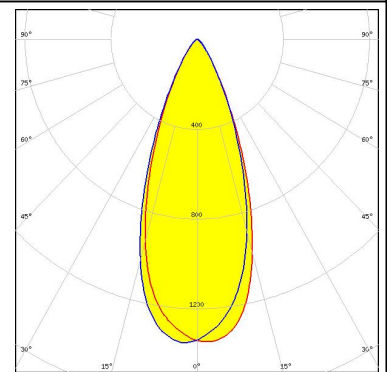
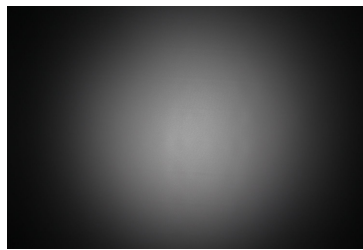

LED LUXEON CZ
 FWHM 42.0°
 Efficiency 93 %
 Peak intensity 1.4 cd/lm
 LEDs/each optic 1
 Light colour White
 Required components:

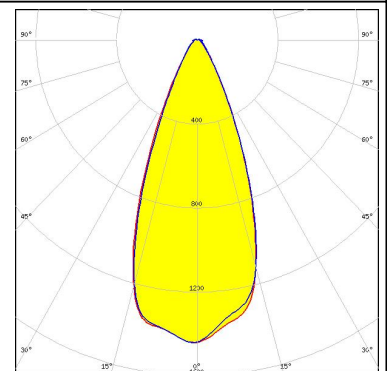
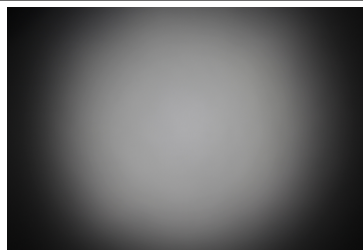

LED LUXEON Rebel
 FWHM 49.0°
 Efficiency 85 %
 Peak intensity 1 cd/lm
 LEDs/each optic 1
 Light colour White
 Required components:

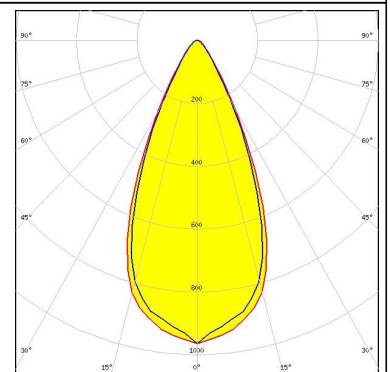

PHOTOMETRIC DATA (MEASURED):

LUMILEDS

LED LUXEON T
 FWHM 44.0°
 Efficiency 83 %
 Peak intensity 1.3 cd/lm
 LEDs/each optic 1
 Light colour White
 Required components:

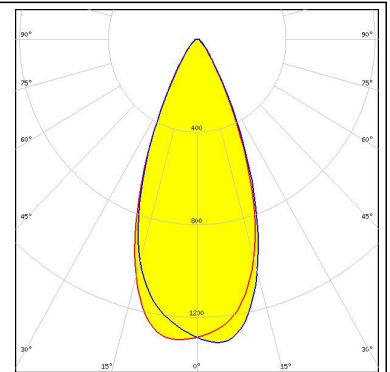

LUMILEDS

LED LUXEON TX
 FWHM 44.0°
 Efficiency 78 %
 Peak intensity 1.3 cd/lm
 LEDs/each optic 1
 Light colour White
 Required components:

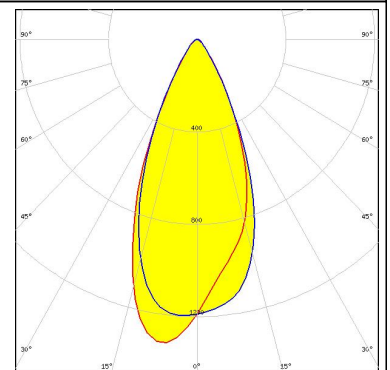
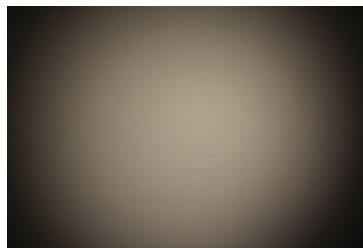

LUMINUS

LED SST-10-B130
 FWHM 43.0°
 Efficiency 90 %
 Peak intensity 1.4 cd/lm
 LEDs/each optic 1
 Light colour Blue
 Required components:

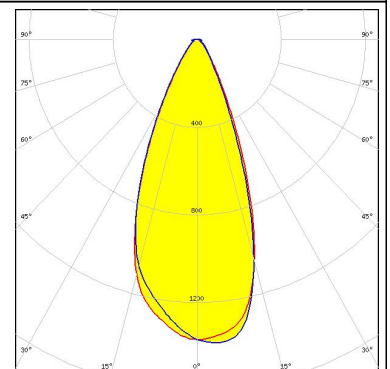
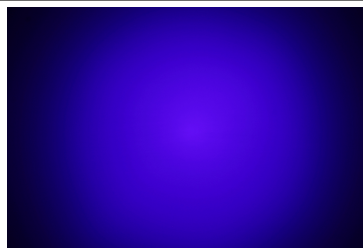



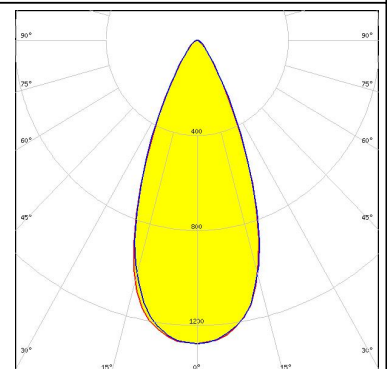
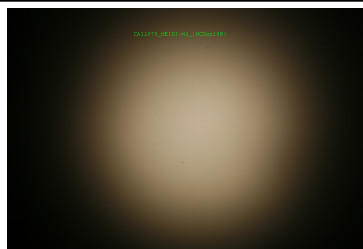

NICHIA

LED NCSxx19B
 FWHM 45.0°
 Efficiency 78 %
 Peak intensity 1.3 cd/lm
 LEDs/each optic 1
 Light colour White
 Required components:

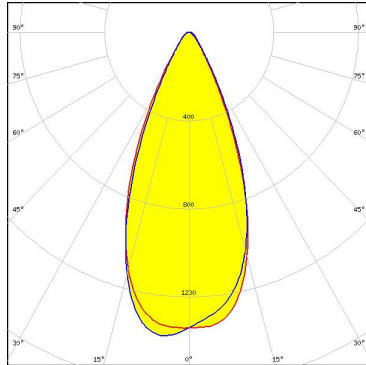

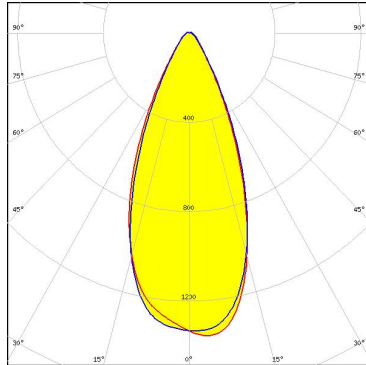
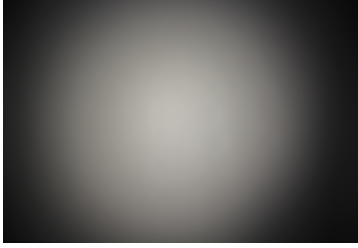
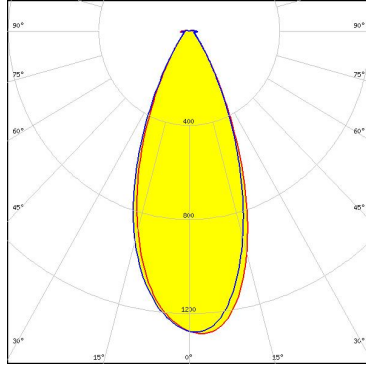
PHOTOMETRIC DATA (MEASURED):

<p>NICHIA</p> <p>LED NVSW219D FWHM 45.0° Efficiency 93 % Peak intensity 1.4 cd/lm LEDs/each optic 1 Light colour White Required components:</p>		
<p>NICHIA</p> <p>LED NVSW319B FWHM 44.0° Efficiency 91 % Peak intensity 1.4 cd/lm LEDs/each optic 1 Light colour White Required components:</p>		
<p>NICHIA</p> <p>LED NVSW3x9A FWHM 42.0° Efficiency 88 % Peak intensity 1.3 cd/lm LEDs/each optic 1 Light colour White Required components:</p>		
<p>NICHIA</p> <p>LED NVSxx19A FWHM 48.0° Efficiency 79 % Peak intensity 0.9 cd/lm LEDs/each optic 1 Light colour White Required components:</p>		

PHOTOMETRIC DATA (MEASURED):



LED NVSxx19B/NVSxx19C
 FWHM 44.0 + 43.0°
 Efficiency 91 %
 Peak intensity 1.4 cd/lm
 LEDs/each optic 1
 Light colour White
 Required components:

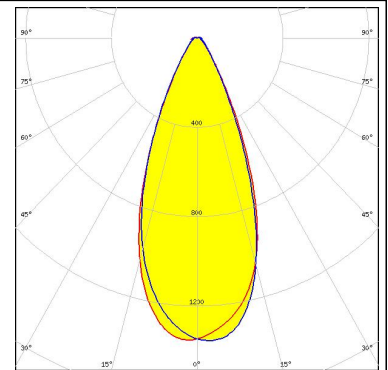

LED NVSxx19B/NVSxx19C
 FWHM 44.0°
 Efficiency 77 %
 Peak intensity 1.2 cd/lm
 LEDs/each optic 1
 Light colour White
 Required components:

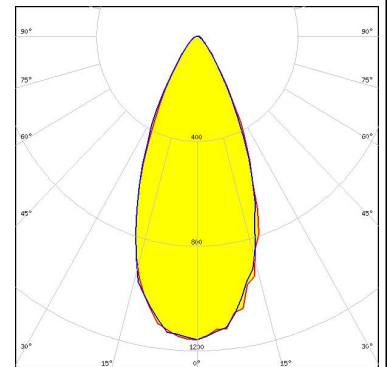
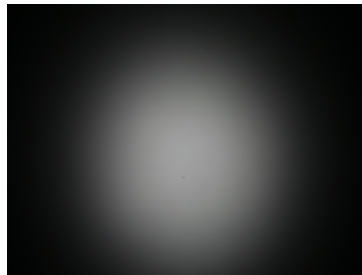

Opto Semiconductors

LED OSOLON Square CSSRM2/CSSRM3
 FWHM 43.0°
 Efficiency 91 %
 Peak intensity 1.4 cd/lm
 LEDs/each optic 1
 Light colour White
 Required components:

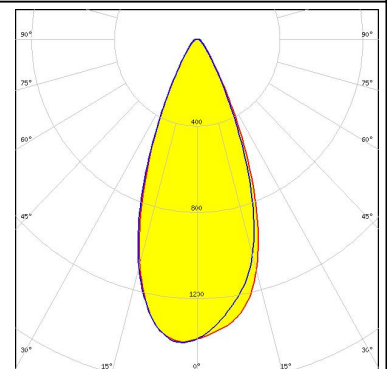
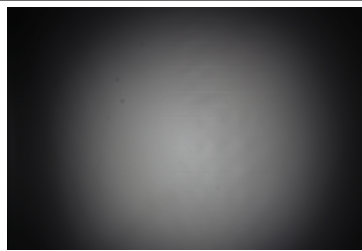

Opto Semiconductors

LED OSOLON SSL 150
 FWHM 40.0°
 Efficiency 81 %
 Peak intensity 1.2 cd/lm
 LEDs/each optic 1
 Light colour White
 Required components:

PHOTOMETRIC DATA (MEASURED):

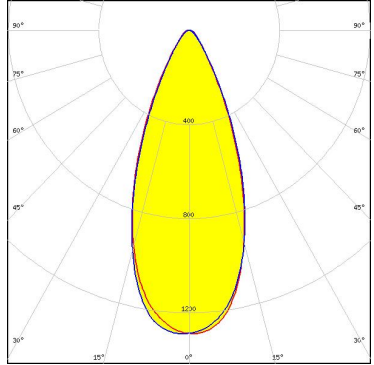
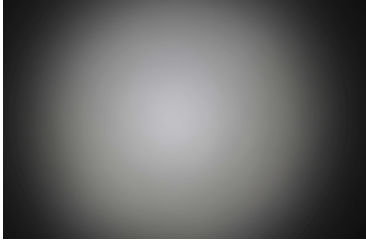
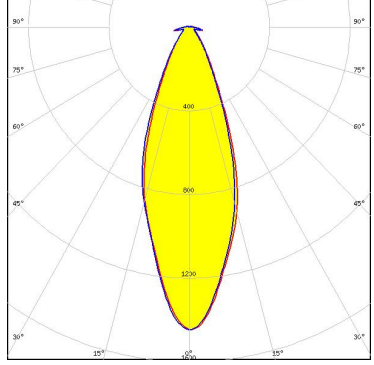
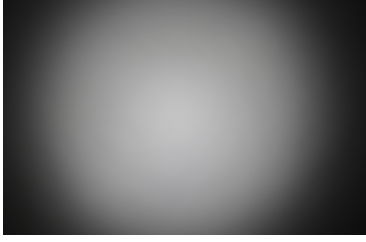
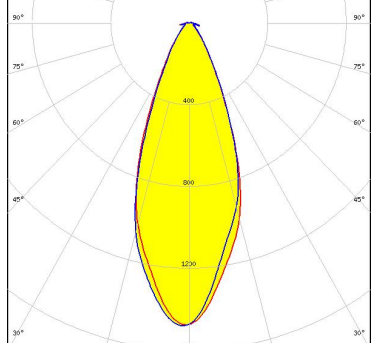
<p>OSRAM Opto Semiconductors</p> <p>LED OSLON SSL 80 FWHM 47.0° Efficiency 80 % Peak intensity 1 cd/lm LEDs/each optic 1 Light colour White Required components:</p>		
<p>PHILIPS</p> <p>LED Fortimo FastFlex 2x8 DS G3 FWHM 42.0° Efficiency 81 % Peak intensity 1.3 cd/lm LEDs/each optic 1 Light colour White Required components:</p>		
<p>SAMSUNG</p> <p>LED LH181A FWHM 38.0° Efficiency 87 % Peak intensity 1.4 cd/lm LEDs/each optic 1 Light colour White Required components:</p>		
<p>SAMSUNG</p> <p>LED LH181B FWHM 40.0° Efficiency 90 % Peak intensity 1.5 cd/lm LEDs/each optic 1 Light colour White Required components:</p>		

PHOTOMETRIC DATA (MEASURED):

SAMSUNG

LED LH351Z
 FWHM 46.0°
 Efficiency 82 %
 Peak intensity 1.3 cd/lm
 LEDs/each optic 1
 Light colour White
 Required components:

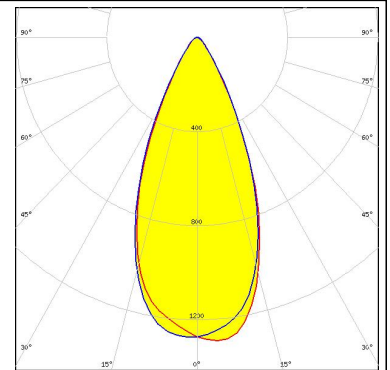
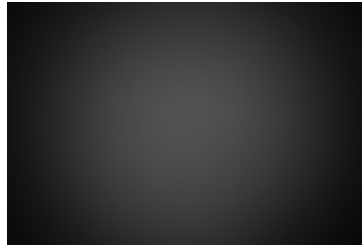

SEOUL SEMICONDUCTOR

LED Z5
 FWHM 44.0°
 Efficiency 76 %
 Peak intensity 1.2 cd/lm
 LEDs/each optic 1
 Light colour White
 Required components:

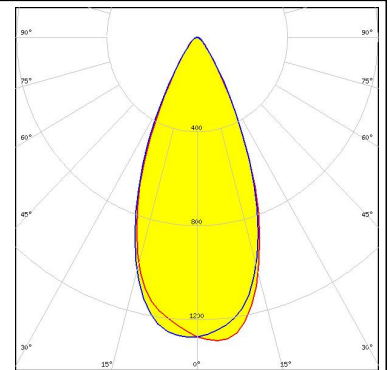
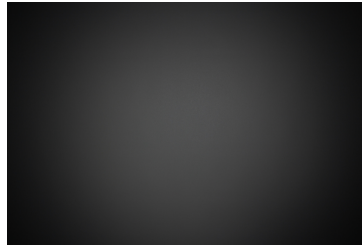

SEOUL SEMICONDUCTOR

LED Z5M1/Z5M2
 FWHM 44.0°
 Efficiency 83 %
 Peak intensity 1.3 cd/lm
 LEDs/each optic 1
 Light colour White
 Required components:

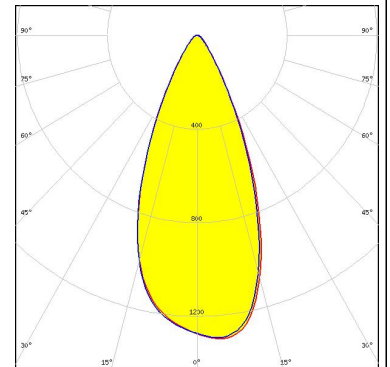
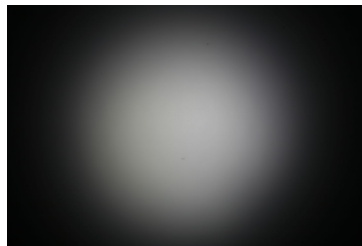

SEOUL SEMICONDUCTOR

LED Z8Y22P
 FWHM 43.0°
 Efficiency 81 %
 Peak intensity 1.1 cd/lm
 LEDs/each optic 1
 Light colour White
 Required components:

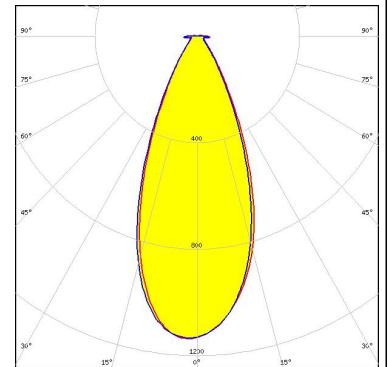
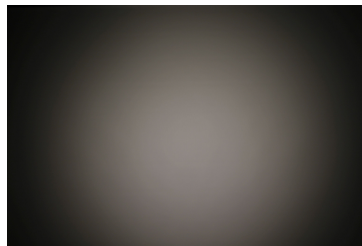

PHOTOMETRIC DATA (MEASURED):

SHARP

LED	Double Dome (GM2BB)
FWHM	44.0°
Efficiency	%
LEDs/each optic	1
Light colour	White
Required components:	

PHOTOMETRIC DATA (SIMULATED):



LED XB-D
 FWHM 42.0°
 Efficiency 89 %
 Peak intensity 1.8 cd/lm
 LEDs/each optic 1
 Light colour White
 Required components:

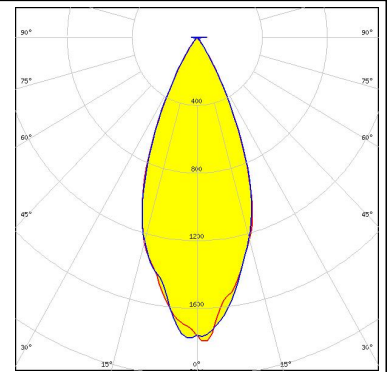

LED XP-G2 HE
 FWHM 45.0°
 Efficiency 92 %
 Peak intensity 1.6 cd/lm
 LEDs/each optic 1
 Light colour White
 Required components:

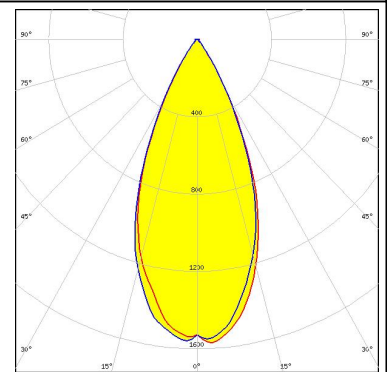

LED LUXEON 3030 HV
 FWHM 46.0°
 Efficiency 93 %
 Peak intensity 1.6 cd/lm
 LEDs/each optic 1
 Light colour White
 Required components:

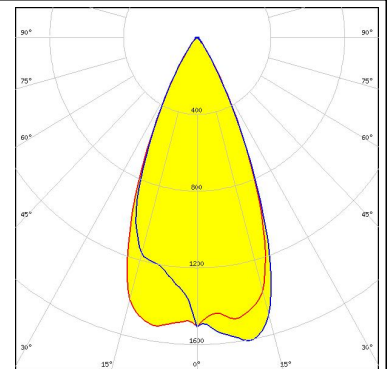

LED LUXEON SunPlus 20 Line (120 deg)
 FWHM 44.0°
 Efficiency 95 %
 Peak intensity 2 cd/lm
 LEDs/each optic 1
 Light colour White
 Required components:

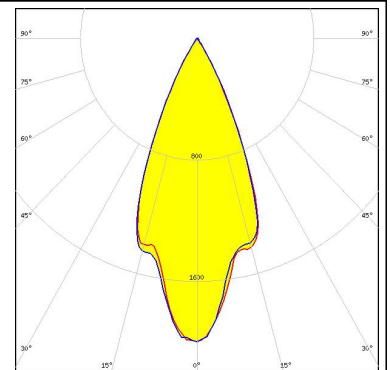

PHOTOMETRIC DATA (SIMULATED):

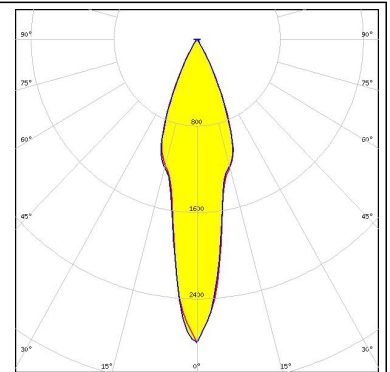
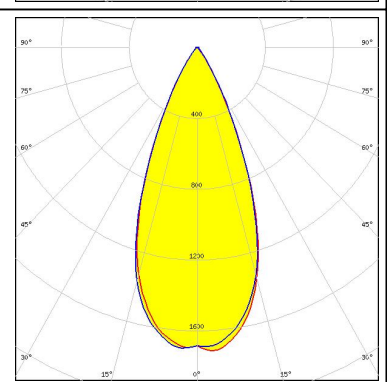
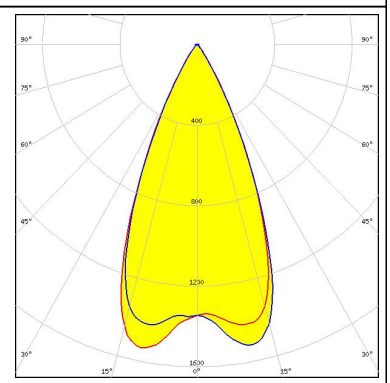
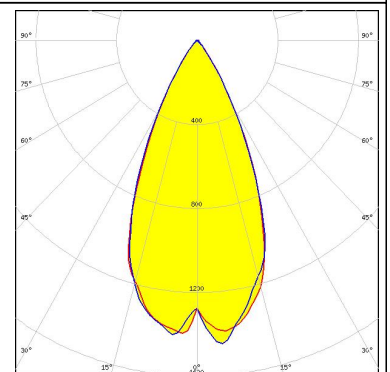
<p>LUMILEDS</p> <p>LED LUXEON SunPlus 20 Line (150 deg) FWHM 21.0° Efficiency 88 % Peak intensity 2.8 cd/lm LEDs/each optic 1 Light colour White Required components:</p>	
<p>LUMILEDS</p> <p>LED LUXEON Z ES FWHM 43.0° Efficiency 94 % Peak intensity 1.7 cd/lm LEDs/each optic 1 Light colour White Required components:</p>	
<p>NICHIA</p> <p>LED NCSxx19A FWHM 47.0° Efficiency 92 % Peak intensity 1.6 cd/lm LEDs/each optic 1 Light colour White Required components:</p>	
<p>NICHIA</p> <p>LED NV4WB35AM FWHM 48.0° Efficiency 93 % Peak intensity 1.5 cd/lm LEDs/each optic 1 Light colour White Required components:</p>	

PHOTOMETRIC DATA (SIMULATED):



LED NVSxx19B/NVSxx19C
 FWHM 48.0°
 Efficiency 94 %
 Peak intensity 1.4 cd/lm
 LEDs/each optic 1
 Light colour White
 Required components:

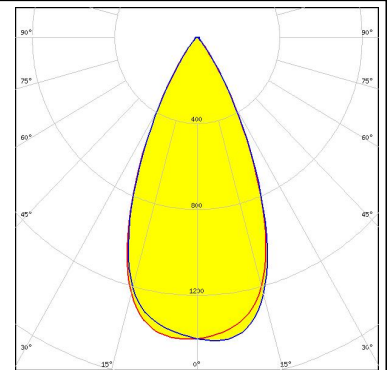

LED OSCONIQ P 3030
 FWHM 46.0°
 Efficiency 93 %
 Peak intensity 1.6 cd/lm
 LEDs/each optic 1
 Light colour White
 Required components:

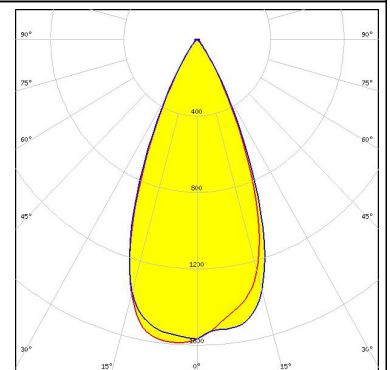

LED OSCONIQ P 3737 Flat
 FWHM 47.0°
 Efficiency 96 %
 Peak intensity 1.5 cd/lm
 LEDs/each optic 1
 Light colour White
 Required components:

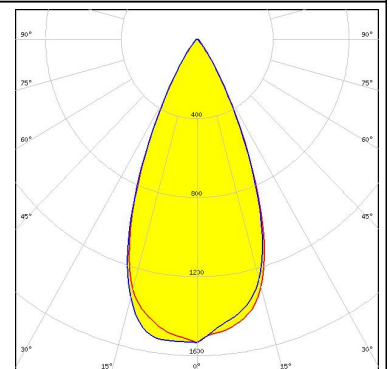

LED OSLOM Square EC
 FWHM 48.0°
 Efficiency 94 %
 Peak intensity 1.6 cd/lm
 LEDs/each optic 1
 Light colour White
 Required components:

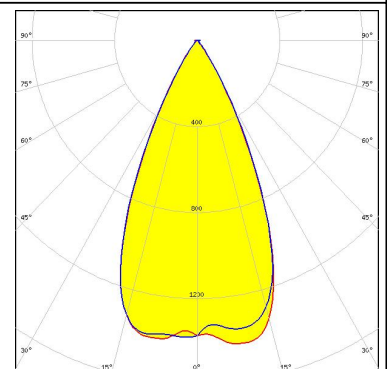
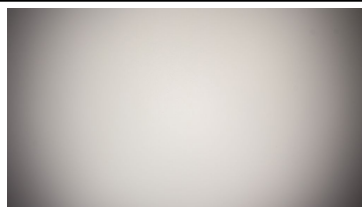

PHOTOMETRIC DATA (SIMULATED):

OSRAM
Opto Semiconductors

LED	OSLON SSL 80
FWHM	42.0°
Efficiency	90 %
Peak intensity	1.8 cd/lm
LEDs/each optic	1
Light colour	White
Required components:	

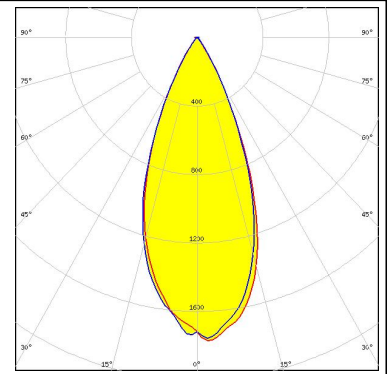

GENERAL INFORMATION:

NOTE: The typical beam angle will be changed by different color, chip size and chip position tolerance. The typical total beam angle is the full angle measured where the luminous intensity is half of the peak value.

MATERIALS:

As part of our continuous research and improvement processes, and to ensure the best possible quality and availability of our products, LEDiL reserves the right to change material grades without notice.

PRODUCT DATA USER AGREEMENT AND DISCLAIMER:

The measured data in the provided downloadable LEDiL Product Datasheets and Mechanical 2D-Drawings is rounded and provided as reference for planning. LEDiL Oy's optical specifications have been verified by conducting performance testing of the products in accordance with the company's quality system. The reported data are averaged results of multiple measurements with typical variation. LEDiL Oy reserves the right to without prior notification make changes and improvements to its products.

LEDiL Oy assumes neither warranty, nor guarantee nor any other liability of any kind for the contents and correctness of the provided data. The provided data has been generated with highest diligence but the provided data may in reality not represent the complete possible variation range of all intrinsic parameters. Therefore, in certain cases a deviation from the provided data could occur.

LEDiL Oy reserves the right to undertake technical changes of its products without further notification which could lead to changes in the provided data. LEDiL Oy assumes no liability of any kind for the possible deviation from any provided data or any other damage resulting from the usage of the provided data.

The user agrees to this disclaimer and user agreement with the download or usage of the provided files.

LEDiL Oy

Joensuunkatu 13
FI-24240 SALO
Finland

LEDiL Inc.

228 West Page Street
Suite D
Sycamore IL 60178
USA

Local sales and technical support

[www.ledil.com/
where_to_buy](http://www.ledil.com/where_to_buy)

Shipping locations

Salo, Finland
Hong Kong, China

Distribution Partners

[www.ledil.com/
where_to_buy](http://www.ledil.com/where_to_buy)

Компания «Life Electronics» занимается поставками электронных компонентов импортного и отечественного производства от производителей и со складов крупных дистрибьюторов Европы, Америки и Азии.

С конца 2013 года компания активно расширяет линейку поставок компонентов по направлению коаксиальный кабель, кварцевые генераторы и конденсаторы (керамические, пленочные, электролитические), за счёт заключения дистрибьюторских договоров

Мы предлагаем:

- Конкуренспособные цены и скидки постоянным клиентам.
- Специальные условия для постоянных клиентов.
- Подбор аналогов.
- Поставку компонентов в любых объемах, удовлетворяющих вашим потребностям.
- Приемлемые сроки поставки, возможна ускоренная поставка.
- Доставку товара в любую точку России и стран СНГ.
- Комплексную поставку.
- Работу по проектам и поставку образцов.
- Формирование склада под заказчика.
- Сертификаты соответствия на поставляемую продукцию (по желанию клиента).
- Тестирование поставляемой продукции.
- Поставку компонентов, требующих военную и космическую приемку.
- Входной контроль качества.
- Наличие сертификата ISO.

В составе нашей компании организован Конструкторский отдел, призванный помогать разработчикам, и инженерам.

Конструкторский отдел помогает осуществить:

- Регистрацию проекта у производителя компонентов.
- Техническую поддержку проекта.
- Защиту от снятия компонента с производства.
- Оценку стоимости проекта по компонентам.
- Изготовление тестовой платы монтаж и пусконаладочные работы.



Тел: +7 (812) 336 43 04 (многоканальный)

Email: org@lifeelectronics.ru