

Description

The AP21410 and AP21510 are integrated high-side power switches optimized for Universal Serial Bus (USB) and other hot-swap applications. The family of devices complies with USB 2.0 and is available with both polarities of Enable input. They offer current and thermal limiting and short circuit protection as well as controlled rise time and undervoltage lockout functionality.

All devices are available in U-DFN2018-6 packages.

Pin Assignments

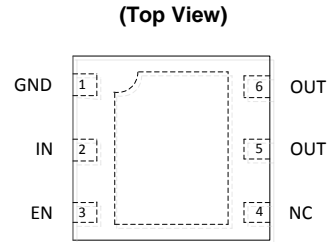

U-DFN2018-6

Features

- Single USB Port Power Switches
- Overcurrent and Thermal Protection
- 0.4A Typical Current Limiting
- Reverse Current Blocking
- 95mΩ On-Resistance
- Input Voltage Range: 2.7V to 5.5V
- 0.4ms Typical Rise Time
- Very Low Shutdown Current: 1μA (Max)
- ESD Protection: 4KV HBM, 400V MM
- Active Low (AP21410) or Active High (AP21510) Enable
- Ambient Temperature Range -40°C to +85°C
- U-DFN2018-6: Available in "Green" Molding Compound (No Br, Sb)
- 15kV ESD Protection per IEC 61000-4-2 (with External Capacitance)
- UL Recognized, File Number E322375
- IEC60950-1 CB Scheme Certified
- **Totally Lead-Free & Fully RoHS Compliant (Notes 1 & 2)**
- **Halogen and Antimony Free. "Green" Device (Note 3)**

Applications

- Consumer Electronics – LCD TVs & Monitors, Game Machines
- Communications – Set-Top Boxes, GPS, Smartphones
- Computing – Laptops, Desktops, Servers, Printers, Docking Stations, HUBs

Notes: 1. No purposely added lead. Fully EU Directive 2002/95/EC (RoHS) & 2011/65/EU (RoHS 2) compliant.
 2. See http://www.diodes.com/quality/lead_free.html for more information about Diodes Incorporated's definitions of Halogen- and Antimony-free, "Green" and Lead-free.
 3. Halogen- and Antimony-free "Green" products are defined as those which contain <900ppm bromine, <900ppm chlorine (<1500ppm total Br + Cl) and <1000ppm antimony compounds.

Typical Applications Circuit

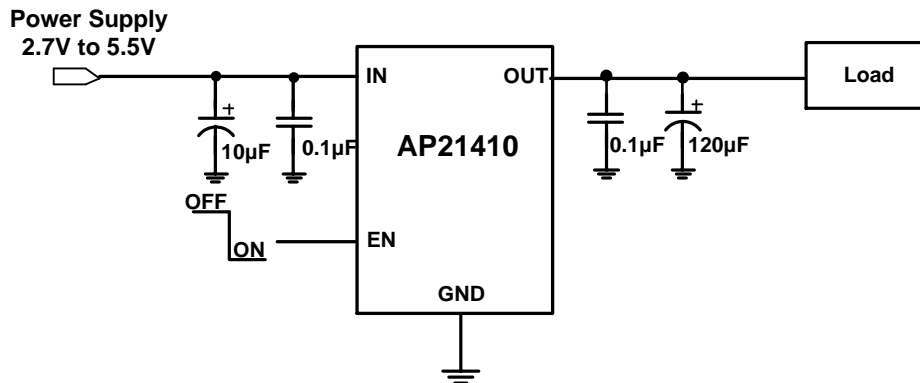

Available Options

Part Number	Channel	Enable Pin (EN)	Current Limit (Typical)	Recommended Maximum Continuous Load Current
AP21410	1	Active Low	0.4A	0.2A
AP21510	1	Active High	0.4A	0.2A

Pin Descriptions

Pin Number	Pin Name	Function
1	GND	Ground
2	IN	Voltage Input Pin (all IN pins must be tied together externally).
3	EN	Enable Input. Active Low (AP21410) and Active High (AP21510)
4	NC	No internal connection
5, 6	OUT	Voltage Output Pin (all OUT pins must be tied together externally).
Exposed Pad	Exposed Pad	Exposed Pad. It should be externally connected to GND plane and thermal mass for enhanced thermal impedance. It should not be used as electrical ground conduction path.

Functional Block Diagram

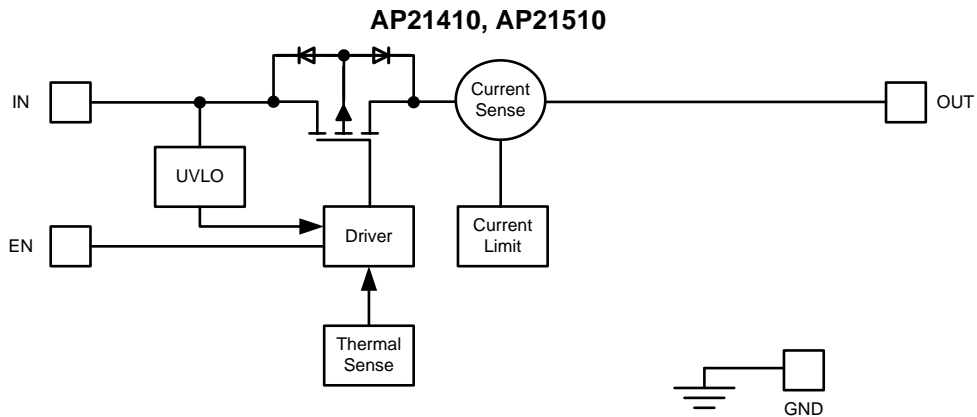

Absolute Maximum Ratings (@T_A = +25°C, unless otherwise specified.)

Symbol	Parameter		Ratings	Units	
ESD	HBM	Human Body Model ESD Protection	4	kV	
	MM	Machine Model ESD Protection	400	V	
	IEC System Level	Surges per EN61000-4-2. 1999 applied to output terminals of EVM (Note 5)	Air	15	kV
		Surges per EN61000-4-2. 1999 applied to output terminals of EVM (Note 5)	Contact	8	kV
V _{IN}	Input Voltage		6.5	V	
V _{OUT}	Output Voltage		V _{IN} +0.3	V	
V _{EN}	Enable Voltage		6.5	V	
I _{LOAD}	Maximum Continuous Load Current		Internal Limited	A	
T _{J(MAX)}	Maximum Junction Temperature		+150	°C	
T _{ST}	Storage Temperature Range (Note 4)		-65 to +150	°C	

Caution: Stresses greater than the 'Absolute Maximum Ratings' specified above, may cause permanent damage to the device. These are stress ratings only; functional operation of the device at these or any other conditions exceeding those indicated in this specification is not implied. Device reliability may be affected by exposure to absolute maximum rating conditions for extended periods of time. Semiconductor devices are ESD sensitive and may be damaged by exposure to ESD events. Suitable ESD precautions should be taken when handling and transporting these devices.

- Notes:
- UL Recognized Rating from -30°C to +70°C (Diodes qualified T_{ST} from -65°C to +150°C).
 - External capacitors need to be connected to the output, EVM board was tested with capacitor 2.2µF 50V 0805. This level is a pass test only and not a limit.

Recommended Operating Conditions (@T_A = +25°C, unless otherwise specified.)

Symbol	Parameter	Min	Max	Units
V _{IN}	Input Voltage	2.7	5.5	V
I _{OUT}	Output Current	0	200	mA
T _A	Operating Ambient Temperature	-40	+85	°C
V _{IL}	EN Input Logic Low Voltage	0	0.8	V
V _{IH}	EN Input Logic High Voltage	2	V _{IN}	V

Electrical Characteristics (@ $T_A = +25^\circ\text{C}$, $V_{IN} = +5.0\text{V}$, unless otherwise specified.)

Symbol	Parameter	Conditions	Min	Typ	Max	Unit		
V_{UVLO}	Input UVLO	$R_{LOAD} = 1\text{k}\Omega$	1.6	1.9	2.5	V		
I_{SHDN}	Input Shutdown Current	Disabled, $I_{OUT} = 0$	—	0.5	1	μA		
I_Q	Input Quiescent Current	Enabled, $I_{OUT} = 0$	—	45	70	μA		
I_{LEAK}	Input Leakage Current	Disabled, OUT Grounded	—	—	1	μA		
I_{REV}	Reverse Leakage Current	Disabled, $V_{IN} = 0\text{V}$, $V_{OUT} = 5\text{V}$, I_{REV} at V_{IN}	—	0.01	1	μA		
$R_{DS(ON)}$	Switch On-Resistance	$V_{IN} = 5\text{V}$, $I_{OUT} = 0.2\text{A}$	$T_A = +25^\circ\text{C}$	U-DFN2018-6	—	80	110	m Ω
			$-40^\circ\text{C} \leq T_A \leq +85^\circ\text{C}$		—	—	140	
		$V_{IN} = 3.3\text{V}$, $I_{OUT} = 0.2\text{A}$	$T_A = +25^\circ\text{C}$	—	100	140		
			$-40^\circ\text{C} \leq T_A \leq +85^\circ\text{C}$		—	—	170	
I_{SHORT}	Short-Circuit Current Limit	Enabled into Short Circuit	—	250	—	mA		
T_{SHORT}	Short-Circuit Response Time	$V_{OUT} = 0\text{V}$ to $I_{OUT} = I_{SHORT}$ (OUT shorted to ground) Note: See Figure 2	—	2	—	μs		
I_{LIMIT}	Over-Load Current Limit	$V_{IN} = 5\text{V}$, $V_{OUT} = 4.5\text{V}$, $-40^\circ\text{C} \leq T_A \leq +85^\circ\text{C}$	300	400	500	mA		
I_{SINK}	EN Input Leakage	$V_{EN} = 5\text{V}$	—	—	1	μA		
$t_{D(ON)}$	Output Turn-On Delay Time	$R_{LOAD} = 25\Omega$	—	0.05	—	ms		
t_R	Output Turn-On Rise Time	$R_{LOAD} = 25\Omega$	—	0.4	1.5	ms		
$t_{D(OFF)}$	Output Turn-Off Delay Time	$R_{LOAD} = 25\Omega$	—	0.14	—	ms		
t_F	Output Turn-Off Fall Time	$R_{LOAD} = 25\Omega$	—	0.04	0.1	ms		
T_{SHDN}	Thermal Shutdown Threshold	Enabled, $R_{LOAD} = 1\text{k}\Omega$	—	+140	—	$^\circ\text{C}$		
T_{HYS}	Thermal Shutdown Hysteresis	—	—	+25	—	$^\circ\text{C}$		
θ_{JA}	Thermal Resistance Junction-to-Ambient	U-DFN2018-6 (Note 6)	—	70	—	$^\circ\text{C}/\text{W}$		

Note: 6. Test condition for U-DFN2018-6: Device mounted on FR-4 2-layer board, 2oz copper, with minimum recommended pad on top layer and 3 vias to bottom layer 1.0" x 1.4" ground plane.

Performance Characteristics

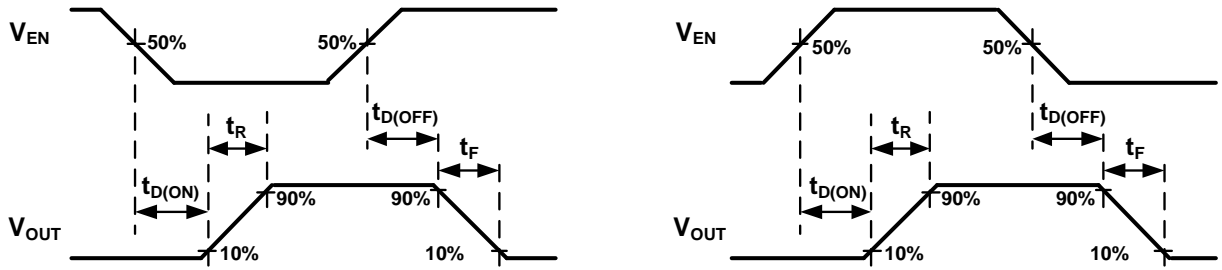

Figure 1. Voltage Waveforms: AP21410 (Left), AP21510 (Right)

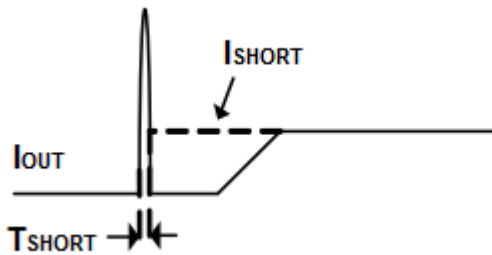
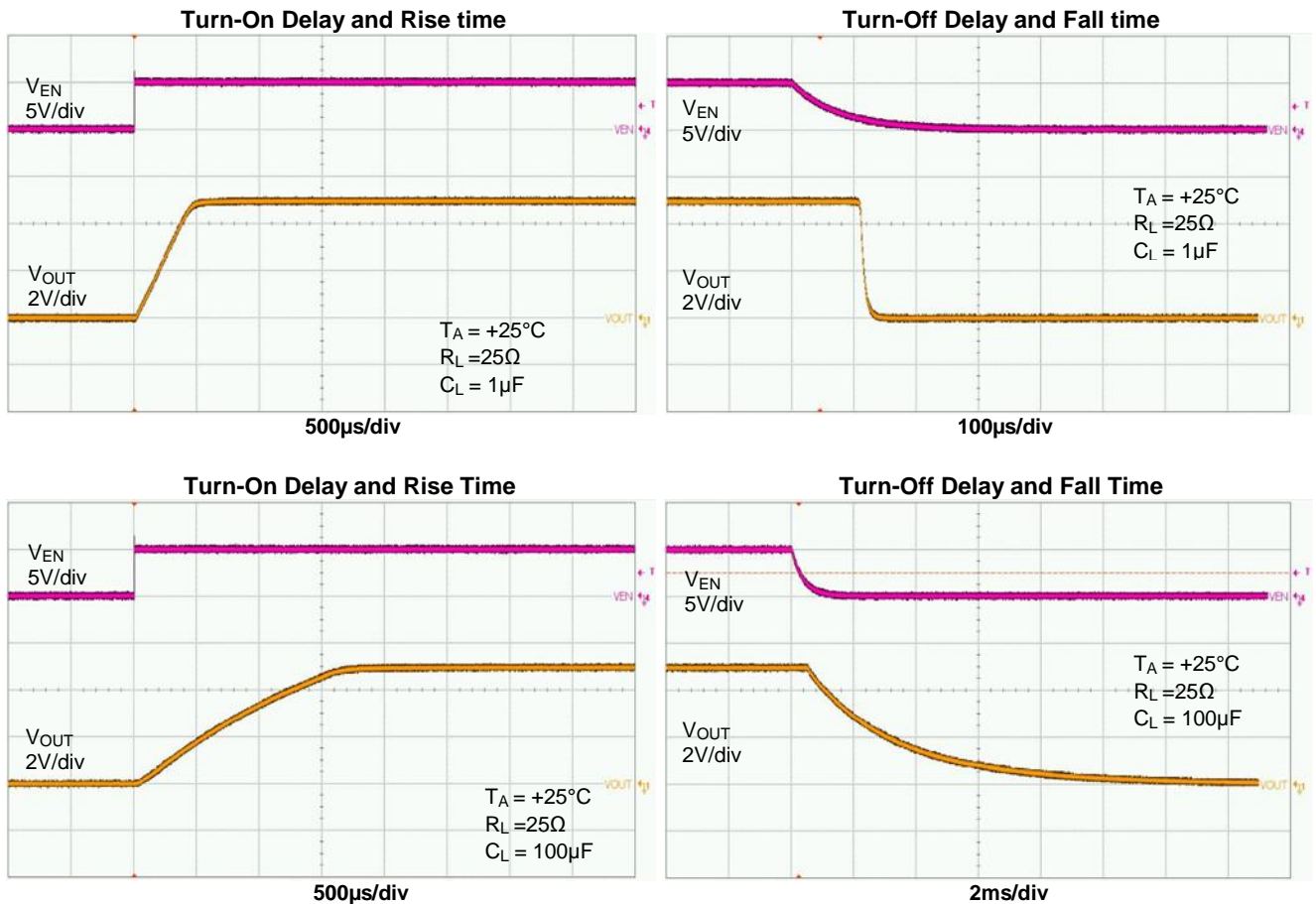
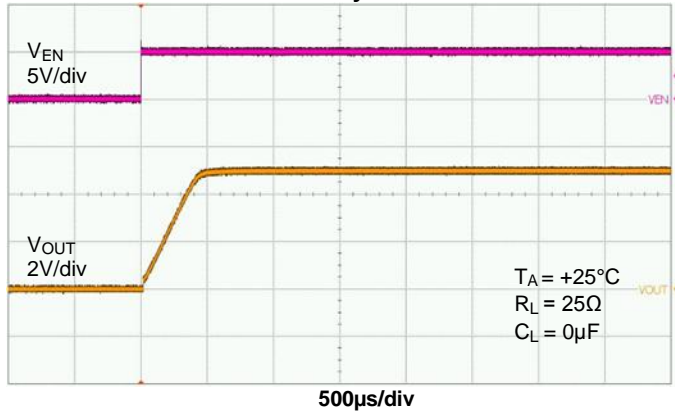

Figure 2. Response Time to Short Circuit Waveform



Performance Characteristics (continued)

Turn On Delay and Rise Time



Turn Off Delay and Fall time

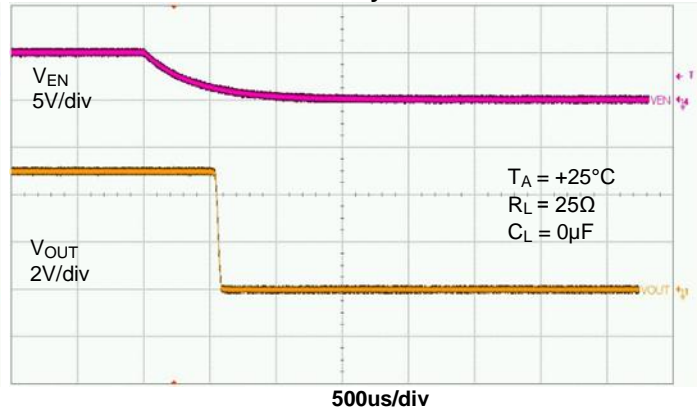

Short Circuit Current, Device Enabled Into Short

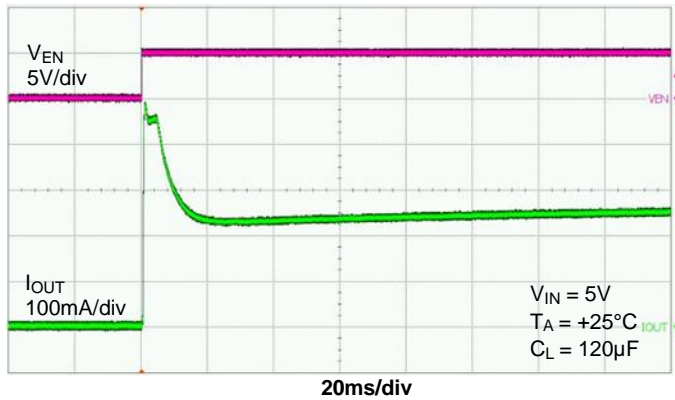

Short Circuit Current, Device Enabled Into Short

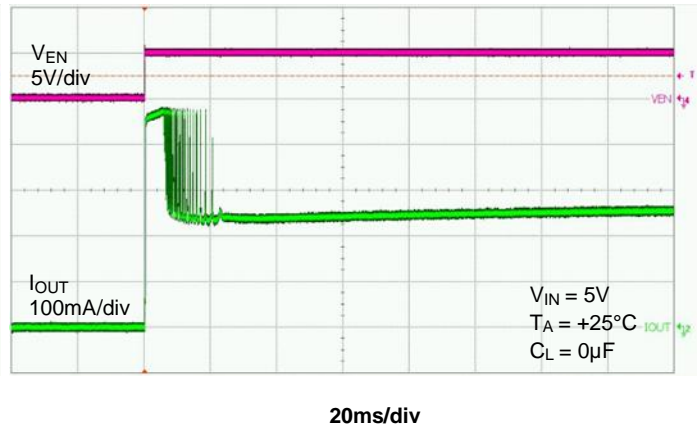

Inrush Current

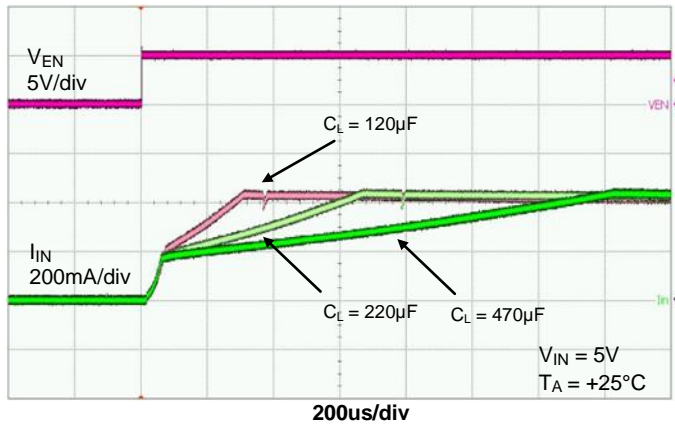

Over Load Current Limit

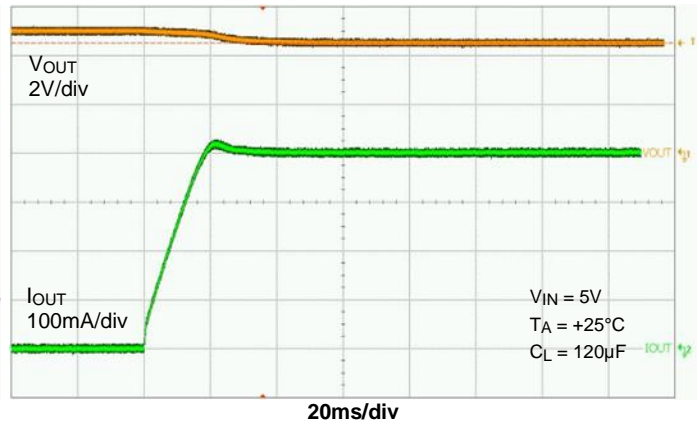

Performance Characteristics (cont.)

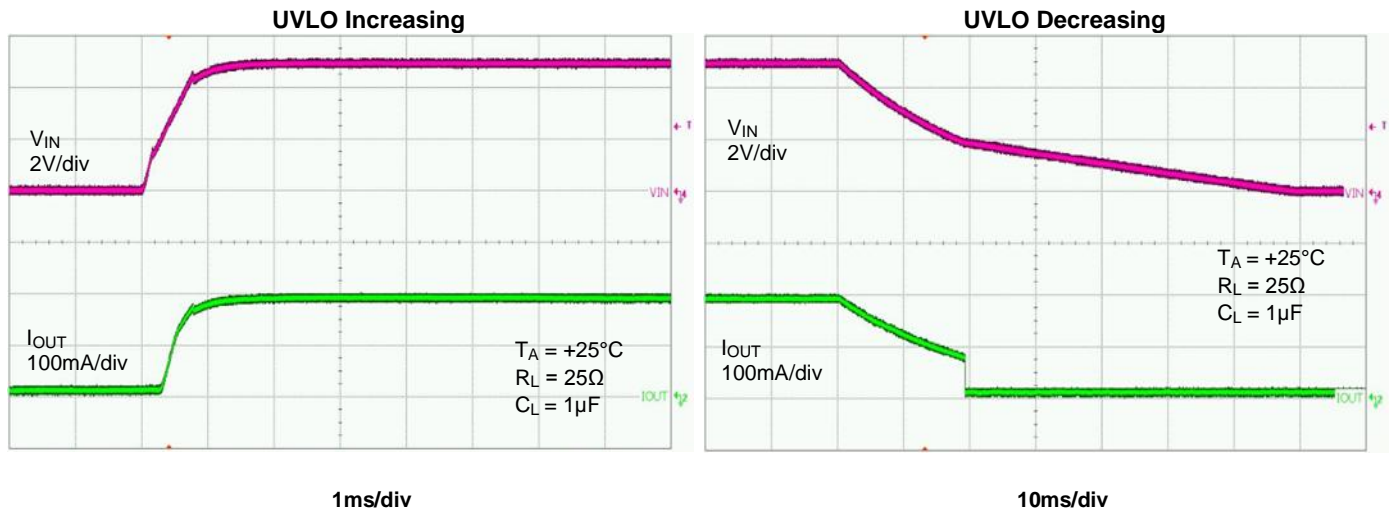
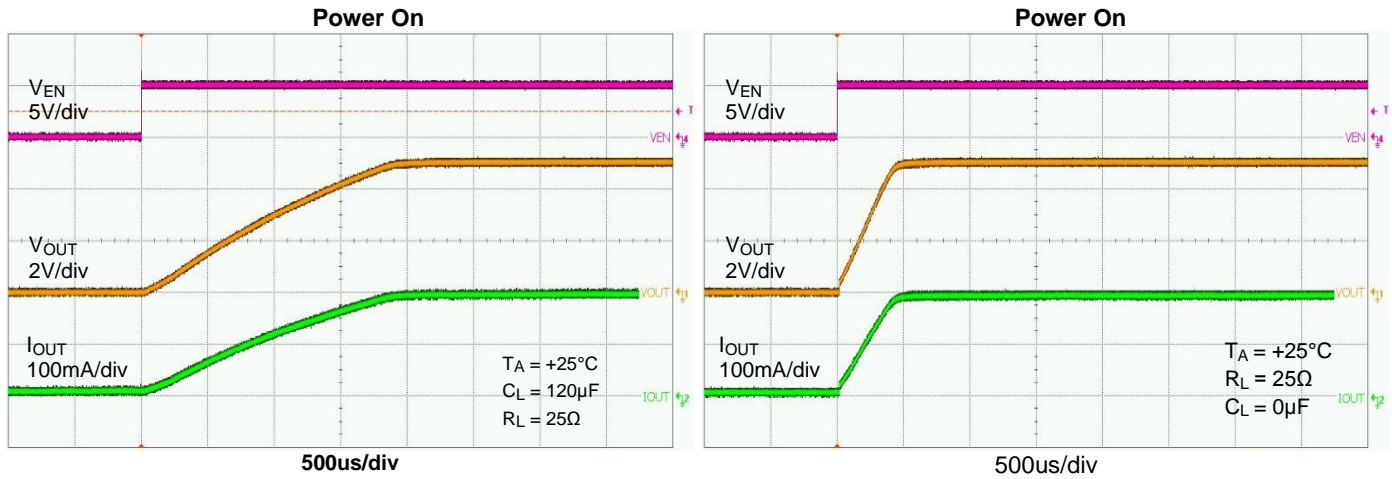

Performance Characteristics (cont.)

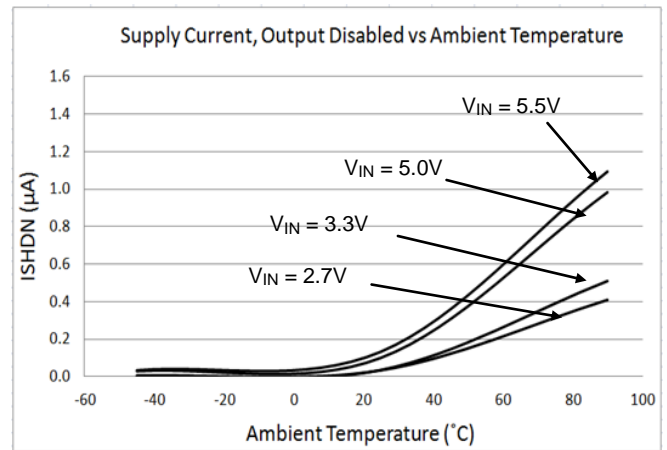
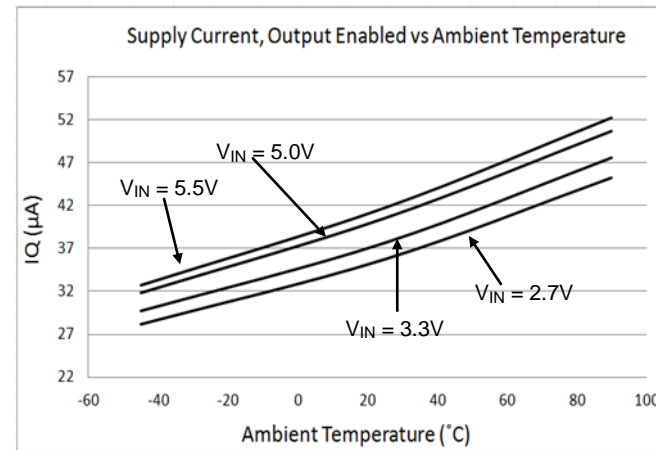
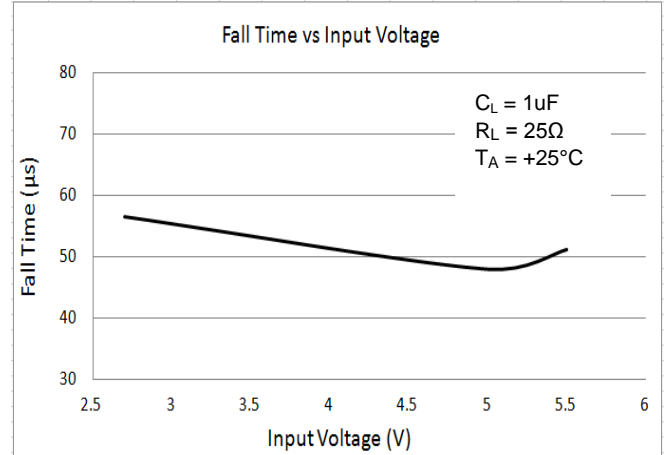
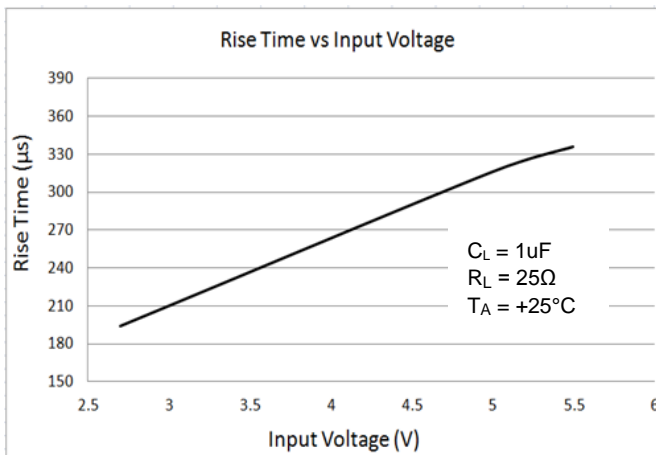
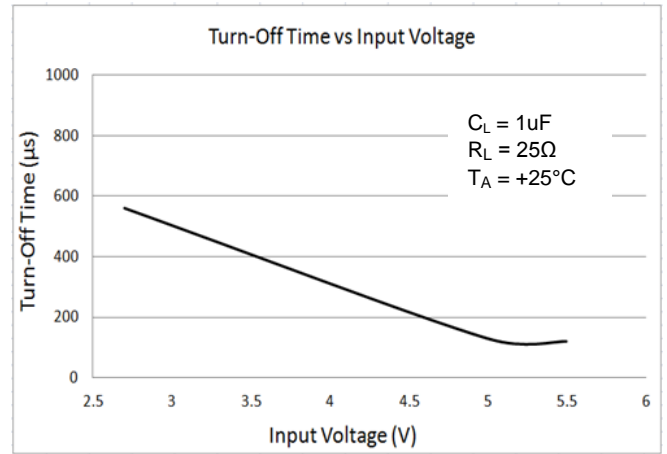
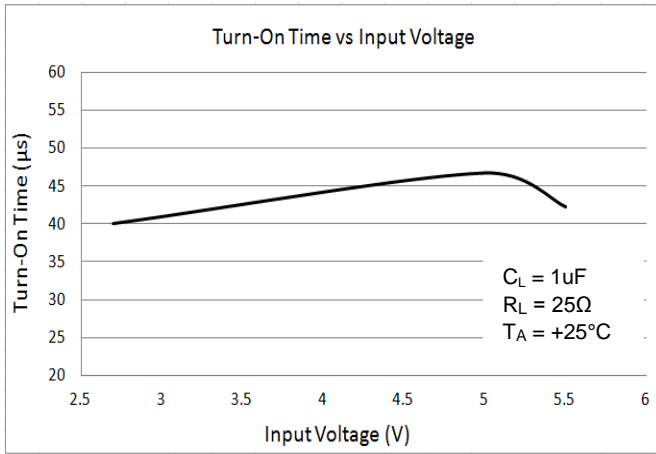

Performance Characteristics (cont.)

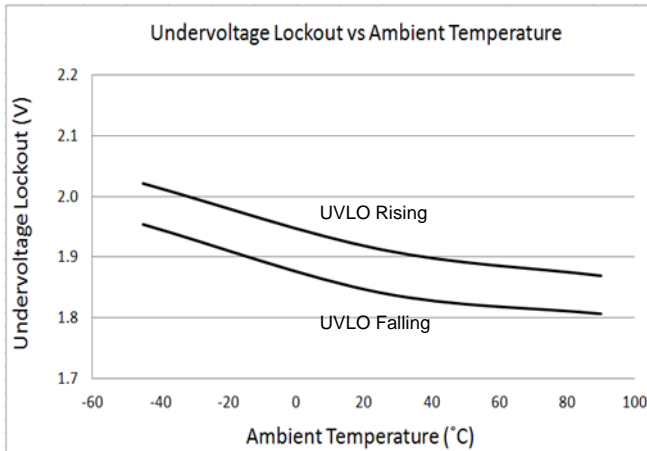
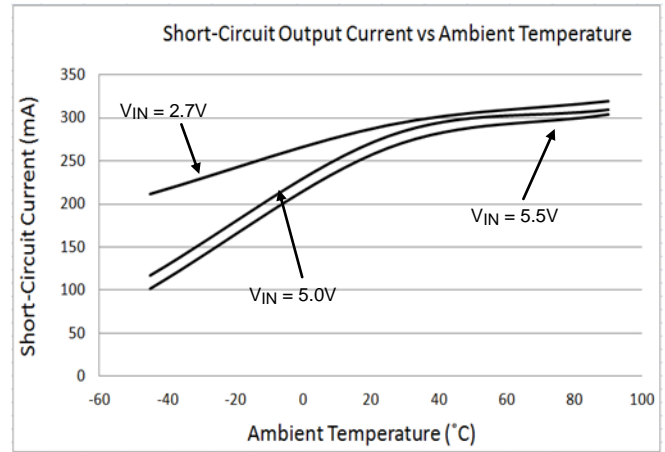
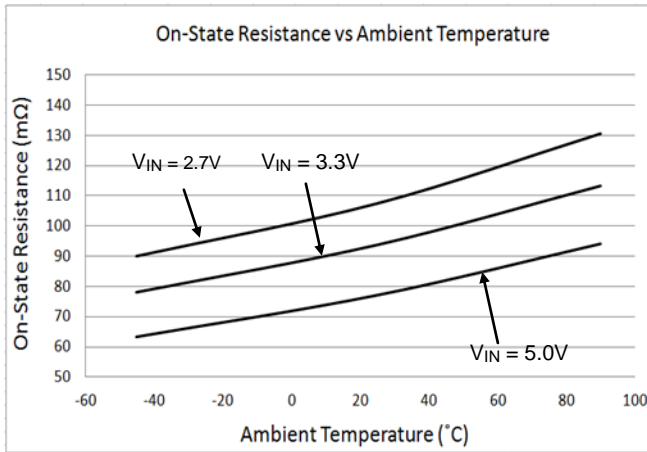

Application Information

Power Supply Considerations

A 0.01 μ F to 0.1 μ F X7R or X5R ceramic bypass capacitor between IN and GND, close to the device, is recommended. Placing a high-value electrolytic capacitor on the input (10 μ F minimum) and output pin(s) is recommended when the output load is heavy. This precaution reduces power-supply transients that may cause ringing on the input. Additionally, bypassing the output with a 0.01 μ F to 0.1 μ F ceramic capacitor improves the immunity of the device to short-circuit transients.

Overcurrent and Short Circuit Protection

An internal sensing FET is employed to check for overcurrent conditions. Unlike current-sense resistors, sense FETs do not increase the series resistance of the current path. When an overcurrent condition is detected, the device maintains a constant output current and reduces the output voltage accordingly. Complete shutdown occurs only if the fault stays long enough to activate thermal limiting.

Three possible overload conditions can occur. In the first condition, the output has been shorted to GND before the device is enabled or before V_{IN} has been applied. The AP21410 / AP21510 short circuit and clamps output current to a certain safe level namely I_{SHORT} .

In the second condition, an overload occurs while the device is enabled. At the instance the overload occurs, higher current may flow for a very short period of time before the current-limit function can react. After the current limit function has tripped (reached the overcurrent trip threshold), the device switches into current limiting mode and the current is clamped at I_{LIMIT} .

In the third condition, the load has been gradually increased beyond the recommended operating current. The current is permitted to rise until the current-limit threshold is reached or until the thermal limit of the device is exceeded. The AP21410 / AP21510 is capable of delivering current up to the current-limit threshold without damaging the device. Once the threshold has been reached, the device switches into overload current limiting mode and is set at I_{LIMIT} . If the load current keeps going higher, the device will switch into short-circuit current limiting mode and is set at I_{SHORT} .

Note that when the output has been shorted to GND at extremely low temperatures (< -30°C), a minimum 120 μ F electrolytic capacitor on the output pin is recommended. A correct capacitor type with capacitor voltage rating and temperature characteristics must be properly chosen so that the capacitance value does not drop too low at the extremely low temperature operation. A recommended capacitor should have temperature characteristics of less than 10% variation of capacitance change when operated at extremely low temp. Our recommended aluminum electrolytic capacitor type is Panasonic FC series.

Power Dissipation and Junction Temperature

The low on-resistance of the internal MOSFET allows the small surface-mount packages to pass large current. Using the maximum operating ambient temperature (T_A) and $R_{DS(ON)}$, the power dissipation can be calculated by:

$$P_D = R_{DS(ON)} \times I^2$$

Finally, calculate the junction temperature:

$$T_J = P_D \times R_{\theta JA} + T_A$$

Where:

T_A = Ambient temperature °C

$R_{\theta JA}$ = Thermal resistance

P_D = Total power dissipation

Application Information (continued)

Thermal Protection

Thermal protection prevents the IC from damage when heavy overload or short-circuit faults are present for extended periods of time. The AP21410 / AP21510 implements a thermal sensing to monitor the operating junction temperature of the power distribution switch. Once the die temperature rises to approximately +140°C due to excessive power dissipation in an overcurrent or short-circuit condition, the internal thermal sense circuitry turns the power switch off, thus preventing the power switch from damage. Hysteresis is built into the thermal sense circuit allowing the device to cool down approximately +25°C before the switch turns back on. The switch continues to cycle in this manner until the load fault or input power is removed.

Undervoltage Lockout (UVLO)

Undervoltage lockout function (UVLO) keeps the internal power switch from being turned on until the power supply has reached at least 1.9V, even if the switch is enabled. Whenever the input voltage falls below approximately 1.9V, the power switch is quickly turned off. This facilitates the design of hot-insertion systems where it is not possible to turn off the power switch before input power is removed.

Generic Hot-Plug Applications

In many applications it may be necessary to remove modules or pc boards while the main unit is still operating. These are considered hot-plug applications. Such implementations require the control of current surges seen by the main power supply and the card being inserted. The most effective way to control these surges is to limit and slowly ramp the current and voltage being applied to the card, similar to the way in which a power supply normally turns on. Due to the controlled rise times and fall times of the AP21410 / AP21510, these devices can be used to provide a softer start-up to devices being hot-plugged into a powered system. The UVLO feature of the AP21410 / AP21510 also ensures that the switch is off after the card has been removed, and that the switch is off during the next insertion.

By placing the AP21410 / AP21510 between the V_{CC} input and the rest of the circuitry, the input power reaches these devices first after insertion. The typical rise time of the switch is approximately 1ms, providing a slow voltage ramp at the output of the device. This implementation controls system surge current and provides a hot-plugging mechanism for any device.

Dual-Purpose Port Applications

AP21410/AP21510 is suitable for use in dual-purpose port applications in which a single port is used for data communication between the host and peripheral devices while simultaneously maintaining a charge to the battery of the peripheral device. An example of this is a shared HDMI/MHL (Mobile High-definition Link) port that allows streaming video between an HDTV or set-top box and a smartphone or tablet while maintaining a charge to the smartphone or tablet battery. In such dual-purpose port applications, it is important to insure Vin of the AP21410/AP21510 is ramped to its operating voltage prior to enabling the output.

No Output Capacitor Applications

For certain applications, no output capacitor is allowed. It is recommended to add a schottky diode at the output pin to prevent the device damaged by output accidentally short to ground.

Note: All previous Typical Performance Characteristics charts marked C_L=0μF have the schottky diode added.

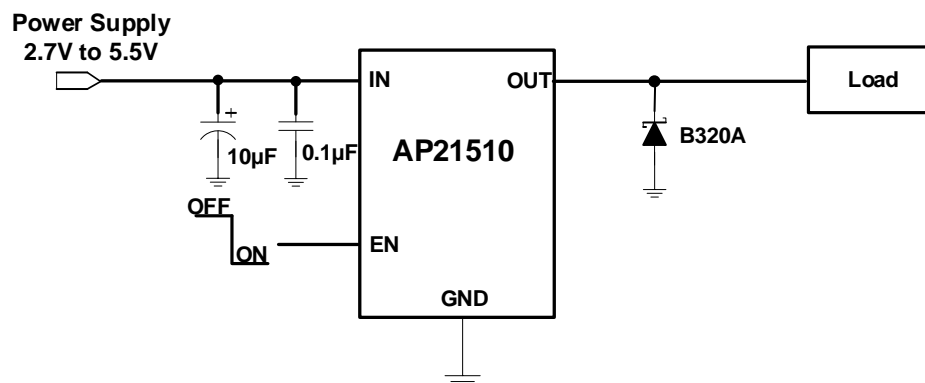
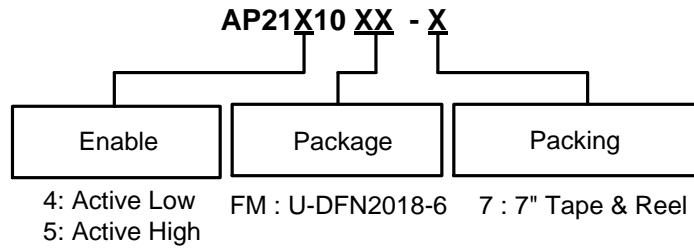

Figure 3. No Output Capacitor Application

Ordering Information (Note 7)



Part Number	Package Code	Packaging	7" Tape and Reel	
			Quantity	Part Number Suffix
AP21410FM-7	FM	U-DFN2018-6	3,000/Tape & Reel	-7
AP21510FM-7	FM	U-DFN2018-6	3,000/Tape & Reel	-7

Note: 7. For packaging details, go to our website at <http://www.diodes.com/products/packages.html>.

Marking Information

(1) U-DFN2018-6

(Top View)

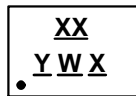

XX : Identification Code
Y : Year : 0~9
W : Week : A~Z : 1~26 week;
a~z : 27~52 week; z represents
52 and 53 week
X : Internal Code

Device	Package Type	Identification Code
AP21410FM	U-DFN2018-6	GA
AP21510FM	U-DFN2018-6	GP

Package Outline Dimensions (All dimensions in mm.)

Please see AP02002 at <http://www.diodes.com/datasheets/ap02002.pdf> for the latest version.

(1) Package Type: U-DFN2018-6

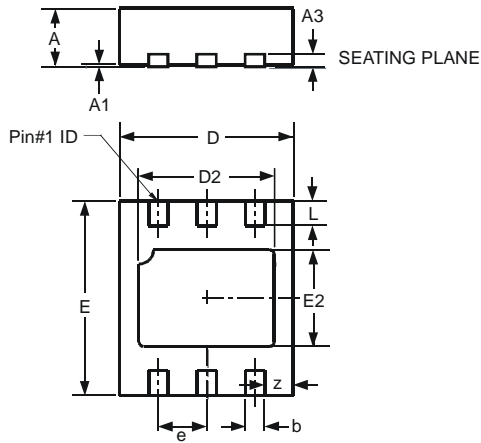

U-DFN2018-6			
Dim	Min	Max	Typ
A	0.545	0.605	0.575
A1	0	0.05	0.02
A3	—	—	0.13
b	0.15	0.25	0.20
D	1.750	1.875	1.80
D2	1.30	1.50	1.40
e	—	—	0.50
E	1.95	2.075	2.00
E2	0.90	1.10	1.00
L	0.20	0.30	0.25
z	—	—	0.30
All Dimensions in mm			

Suggested Pad Layout

Please see AP02001 at <http://www.diodes.com/datasheets/ap02001.pdf> for the latest version.

(1) Package Type: U-DFN2018-6

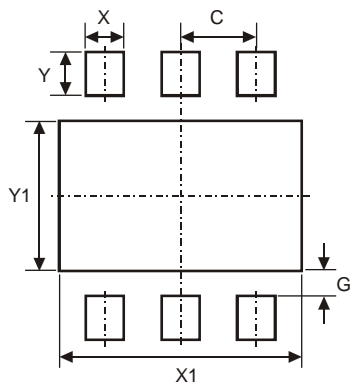

Dimensions	Value (in mm)
C	0.50
G	0.20
X	0.25
X1	1.60
Y	0.35
Y1	1.20

IMPORTANT NOTICE

DIODES INCORPORATED MAKES NO WARRANTY OF ANY KIND, EXPRESS OR IMPLIED, WITH REGARDS TO THIS DOCUMENT, INCLUDING, BUT NOT LIMITED TO, THE IMPLIED WARRANTIES OF MERCHANTABILITY AND FITNESS FOR A PARTICULAR PURPOSE (AND THEIR EQUIVALENTS UNDER THE LAWS OF ANY JURISDICTION).

Diodes Incorporated and its subsidiaries reserve the right to make modifications, enhancements, improvements, corrections or other changes without further notice to this document and any product described herein. Diodes Incorporated does not assume any liability arising out of the application or use of this document or any product described herein; neither does Diodes Incorporated convey any license under its patent or trademark rights, nor the rights of others. Any Customer or user of this document or products described herein in such applications shall assume all risks of such use and will agree to hold Diodes Incorporated and all the companies whose products are represented on Diodes Incorporated website, harmless against all damages.

Diodes Incorporated does not warrant or accept any liability whatsoever in respect of any products purchased through unauthorized sales channel. Should Customers purchase or use Diodes Incorporated products for any unintended or unauthorized application, Customers shall indemnify and hold Diodes Incorporated and its representatives harmless against all claims, damages, expenses, and attorney fees arising out of, directly or indirectly, any claim of personal injury or death associated with such unintended or unauthorized application.

Products described herein may be covered by one or more United States, international or foreign patents pending. Product names and markings noted herein may also be covered by one or more United States, international or foreign trademarks.

This document is written in English but may be translated into multiple languages for reference. Only the English version of this document is the final and determinative format released by Diodes Incorporated.

LIFE SUPPORT

Diodes Incorporated products are specifically not authorized for use as critical components in life support devices or systems without the express written approval of the Chief Executive Officer of Diodes Incorporated. As used herein:

A. Life support devices or systems are devices or systems which:

1. are intended to implant into the body, or
2. support or sustain life and whose failure to perform when properly used in accordance with instructions for use provided in the labeling can be reasonably expected to result in significant injury to the user.

B. A critical component is any component in a life support device or system whose failure to perform can be reasonably expected to cause the failure of the life support device or to affect its safety or effectiveness.

Customers represent that they have all necessary expertise in the safety and regulatory ramifications of their life support devices or systems, and acknowledge and agree that they are solely responsible for all legal, regulatory and safety-related requirements concerning their products and any use of Diodes Incorporated products in such safety-critical, life support devices or systems, notwithstanding any devices- or systems-related information or support that may be provided by Diodes Incorporated. Further, Customers must fully indemnify Diodes Incorporated and its representatives against any damages arising out of the use of Diodes Incorporated products in such safety-critical, life support devices or systems.

Copyright © 2015, Diodes Incorporated

www.diodes.com

Компания «Life Electronics» занимается поставками электронных компонентов импортного и отечественного производства от производителей и со складов крупных дистрибьюторов Европы, Америки и Азии.

С конца 2013 года компания активно расширяет линейку поставок компонентов по направлению коаксиальный кабель, кварцевые генераторы и конденсаторы (керамические, пленочные, электролитические), за счёт заключения дистрибьюторских договоров

Мы предлагаем:

- Конкурентоспособные цены и скидки постоянным клиентам.
- Специальные условия для постоянных клиентов.
- Подбор аналогов.
- Поставку компонентов в любых объемах, удовлетворяющих вашим потребностям.
- Приемлемые сроки поставки, возможна ускоренная поставка.
- Доставку товара в любую точку России и стран СНГ.
- Комплексную поставку.
- Работу по проектам и поставку образцов.
- Формирование склада под заказчика.
- Сертификаты соответствия на поставляемую продукцию (по желанию клиента).
- Тестирование поставляемой продукции.
- Поставку компонентов, требующих военную и космическую приемку.
- Входной контроль качества.
- Наличие сертификата ISO.

В составе нашей компании организован Конструкторский отдел, призванный помогать разработчикам, и инженерам.

Конструкторский отдел помогает осуществить:

- Регистрацию проекта у производителя компонентов.
- Техническую поддержку проекта.
- Защиту от снятия компонента с производства.
- Оценку стоимости проекта по компонентам.
- Изготовление тестовой платы монтаж и пусконаладочные работы.



Тел: +7 (812) 336 43 04 (многоканальный)

Email: org@lifeelectronics.ru