

EPCOS Sample Kit 2015

# SMD PTC Thermistors

for Limit Temperature Sensing, Superior Series

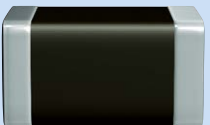

# Features and applications for SMD PTC thermistors

## Features

- Qualification based on AEC-Q200, Rev. D
- Reflow soldering only
- Certified to IEC 60738-1 and IEC 60730-1, annex J15 and J17
- Fast and reliable response
- RoHS-compatible
- UL approval to UL1434
- Lead-free tinned terminations for case sizes 0603 and 0805
- Lead-free ceramics for case sizes 0402 and 0805

## Applications

- Over-temperature protection of power components
- DC/DC converters
- SMPS, adapters
- Notebooks, game consoles
- Lighting: LED lights, dimmers, ballasts
- Automotive LED lighting
- Li-Ion battery pack protection
- Hifi amplifiers

## Application circuit examples

### Over-temperature detection circuit and its output voltage

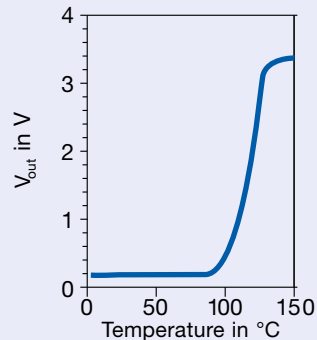
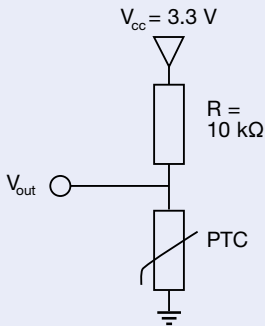

### Example of over-temperature detection for multiple hot spots

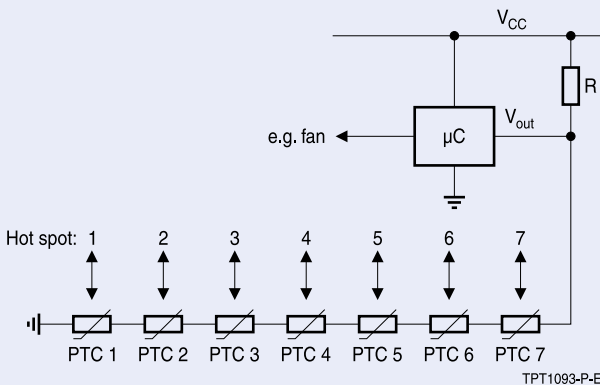

TPT1093-P-E

# Components

EIA 0402 75 °C	EIA 0402 85 °C	EIA 0402 95 °C	EIA 0402 105 °C	EIA 0402 115 °C	EIA 0402 125 °C	EIA 0402 135 °C		
-------------------	-------------------	-------------------	--------------------	--------------------	--------------------	--------------------	--	--

EIA 0603 75 °C	EIA 0603 85 °C	EIA 0603 95 °C	EIA 0603 105 °C	EIA 0603 115 °C	EIA 0603 125 °C	EIA 0603 135 °C	EIA 0603 145 °C	
-------------------	-------------------	-------------------	--------------------	--------------------	--------------------	--------------------	--------------------	--

EIA 0805 70 °C	EIA 0805 80 °C	EIA 0805 90 °C	EIA 0805 100 °C	EIA 0805 110 °C	EIA 0805 120 °C	EIA 0805 130 °C		
-------------------	-------------------	-------------------	--------------------	--------------------	--------------------	--------------------	--	--

## Electrical specifications and ordering codes

EIA case size	$T_{\text{sense},1}$ (@ 4.7 k $\Omega$ ) [°C]	$T_{\text{sense},2}$ (@ 47 k $\Omega$ ) [°C]	$R_R$ ( $V \leq V_{\text{max}}$ ) [ $\Omega$ ]	$\Delta R_R$ [%]	Ordering code		
<b>Superior series, case size 0402</b>							
0402	75 ±5	–	470	±50	B59421A0075A062		
0402	85 ±5	–	470	±50	B59421A0085A062		
0402	95 ±5	–	470	±50	B59421A0095A062		
0402	105 ±5	–	470	±50	B59421A0105A062		
0402	115 ±5	–	470	±50	B59421A0115A062		
0402	125 ±5	–	470	±50	B59421A0125A062		
0402	135 ±5	–	470	±50	B59421A0135A062		
<b>Superior series, case size 0603</b>							
0603	75 ±5	–	470	±50	B59641A0075A062		
0603	85 ±5	100 ±7	470	±50	B59641A0085A062		
0603	95 ±5	110 ±7	470	±50	B59641A0095A062		
0603	105 ±5	120 ±7	470	±50	B59641A0105A062		
0603	115 ±5	130 ±7	470	±50	B59641A0115A062		
0603	125 ±5	140 ±7	470	±50	B59641A0125A062		
0603	135 ±5	150 ±7	470	±50	B59641A0135A062		
0603	145 ±5	–	470	±50	B59641A0145A062		
<b>Superior series, case size 0805</b>							
EIA case size	$T_{\text{sense},1}$ [°C]	$R_R$ ( $V \leq V_{\text{max}}$ ) [ $\Omega$ ]	$\Delta R_R$ [%]	R ( $T_{\text{sense},1} - 5^\circ\text{C}$ ) [k $\Omega$ ]	R ( $T_{\text{sense},1} + 5^\circ\text{C}$ ) [k $\Omega$ ]	R ( $T_{\text{sense},1} + 15^\circ\text{C}$ ) [k $\Omega$ ]	Ordering code
0805	70	680	±50	≤ 5.7	≤ 5.7	–	B59721A0070A062
0805	80	680	±50	≤ 5.7	≤ 5.7	–	B59721A0080A062
0805	90	680	±50	≤ 5.5	≤ 13.3	≥ 40	B59721A0090A062
0805	100	680	±50	≤ 5.5	≤ 13.3	≥ 40	B59721A0100A062
0805	110	680	±50	≤ 5.5	≤ 13.3	≥ 40	B59721A0110A062
0805	120	680	±50	≤ 5.5	≤ 13.3	≥ 40	B59721A0120A062
0805	130	680	±50	≤ 5.5	≤ 13.3	≥ 40	B59721A0130A062

**Important information:** Some parts of this publication contain statements about the suitability of our products for certain areas of application. These statements are based on our knowledge of typical requirements that are often placed on our products. We expressly point out that these statements cannot be regarded as binding statements about the suitability of our products for a particular customer application. It is incumbent on the customer to check and decide whether a product is suitable for use in a particular application. This publication is only a brief product survey which may be changed from time to time. Our products are described in detail in our data sheets. The *Important notes* ([www.epcos.com/ImportantNotes](http://www.epcos.com/ImportantNotes)) and the product-specific *Cautions and warnings* must be observed. All relevant information is available through our sales offices.

## Dimensional drawings in mm

### EIA case size 0402

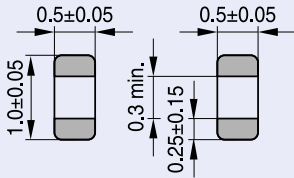

Termination

TPT0948-M-E

### Solder pad

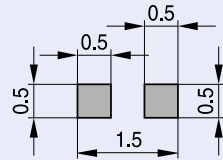

TPT0949-V

Recommended maximum dimensions

### EIA case size 0603

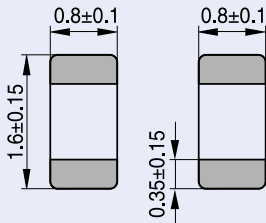

Termination

TPT0698-5-E

### Solder pad

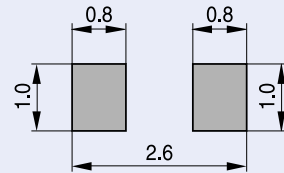

TPT0899-A

Recommended maximum dimensions

### EIA case size 0805

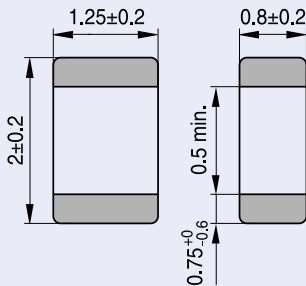

Termination

TPT0650-F-E

### Solder pad

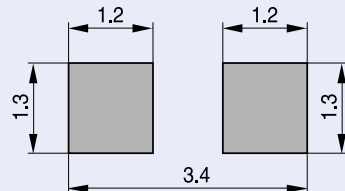

TPT0870-7

Recommended maximum dimensions



# Mouser Electronics

Authorized Distributor

Click to View Pricing, Inventory, Delivery & Lifecycle Information:

[EPCOS / TDK:](#)

[B59001Z0999A099](#)

Компания «Life Electronics» занимается поставками электронных компонентов импортного и отечественного производства от производителей и со складов крупных дистрибьюторов Европы, Америки и Азии.

С конца 2013 года компания активно расширяет линейку поставок компонентов по направлению коаксиальный кабель, кварцевые генераторы и конденсаторы (керамические, пленочные, электролитические), за счёт заключения дистрибьюторских договоров

Мы предлагаем:

- Конкурентоспособные цены и скидки постоянным клиентам.
- Специальные условия для постоянных клиентов.
- Подбор аналогов.
- Поставку компонентов в любых объемах, удовлетворяющих вашим потребностям.
- Приемлемые сроки поставки, возможна ускоренная поставка.
- Доставку товара в любую точку России и стран СНГ.
- Комплексную поставку.
- Работу по проектам и поставку образцов.
- Формирование склада под заказчика.
- Сертификаты соответствия на поставляемую продукцию (по желанию клиента).
- Тестирование поставляемой продукции.
- Поставку компонентов, требующих военную и космическую приемку.
- Входной контроль качества.
- Наличие сертификата ISO.

В составе нашей компании организован Конструкторский отдел, призванный помогать разработчикам, и инженерам.

Конструкторский отдел помогает осуществить:

- Регистрацию проекта у производителя компонентов.
- Техническую поддержку проекта.
- Защиту от снятия компонента с производства.
- Оценку стоимости проекта по компонентам.
- Изготовление тестовой платы монтаж и пусконаладочные работы.



Тел: +7 (812) 336 43 04 (многоканальный)  
Email: [org@lifeelectronics.ru](mailto:org@lifeelectronics.ru)