

## LAURA-W-PG

~40° wide beam. Assembly with white holder and location pins.

### TECHNICAL SPECIFICATIONS:

Dimensions	21.6 mm
Height	13.1 mm
Fastening	glue, pin
ROHS compliant	yes ⓘ

### MATERIAL SPECIFICATIONS:

Component	Type	Material	Colour	Finish
LAURA-W	Single lens	PMMA		
LAURA-HLD-PIN	Holder	PC		

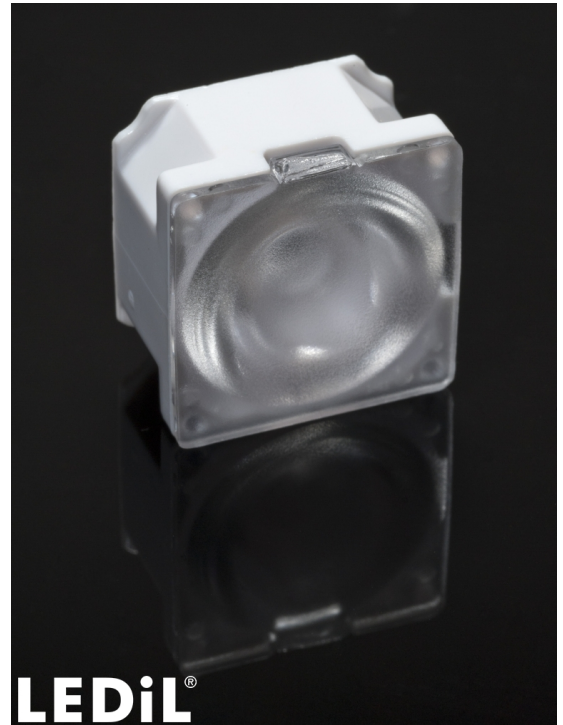

### ORDERING INFORMATION:

Component		Qty in box	MOQ	MPQ	Box weight (kg)
CP12636_LAURA-W-PG	Single lens	1960	294	98	10.8
» Box size: 480 x 280 x 300 mm					

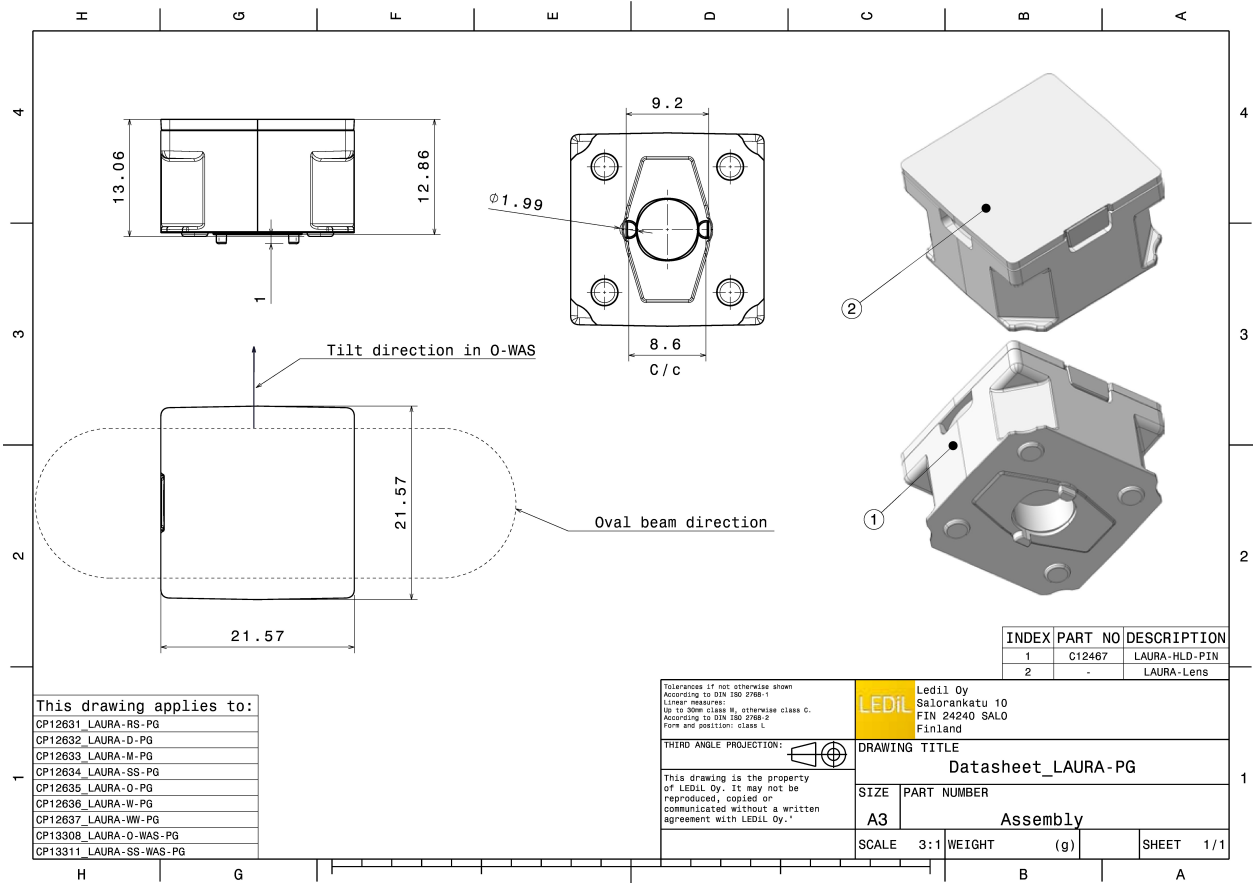

#### PHOTOMETRIC DATA (MEASURED):



LED XP-G  
 FWHM 48.0°  
 Efficiency 91 %  
 Peak intensity 1.400 cd/lm  
 LEDs/each optic 1  
 Light colour White  
 Required components:

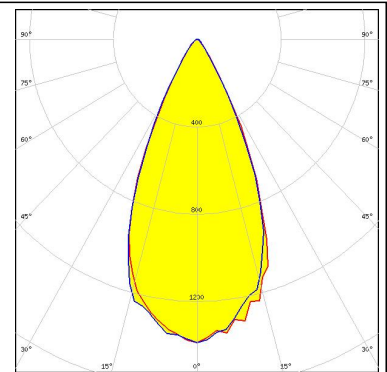
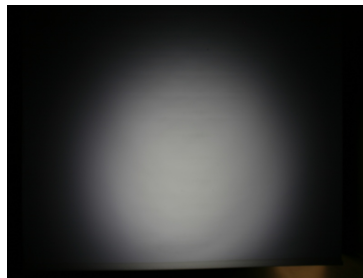

LED XT-E  
 FWHM 40.0°  
 Efficiency 91 %  
 Peak intensity 1.800 cd/lm  
 LEDs/each optic 1  
 Light colour White  
 Required components:

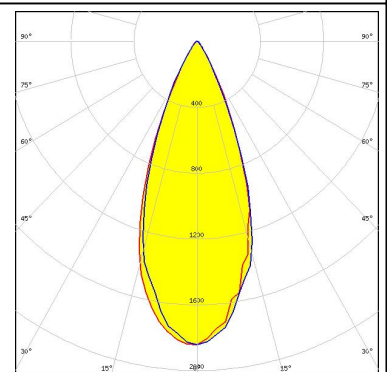
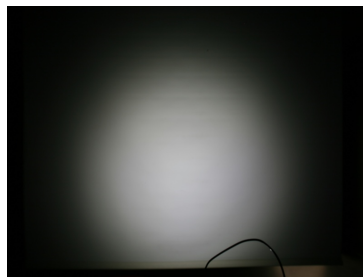

LED LUXEON A  
 FWHM 46.0°  
 Efficiency 92 %  
 Peak intensity 1.400 cd/lm  
 LEDs/each optic 1  
 Light colour White  
 Required components:

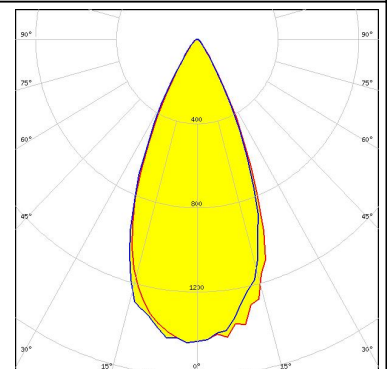
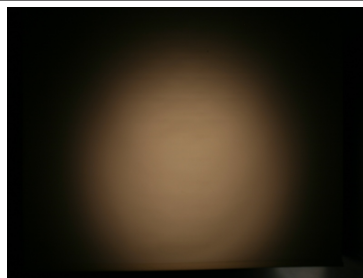

LED LUXEON Rebel  
 FWHM 44.0°  
 Efficiency 88 %  
 Peak intensity 1.800 cd/lm  
 LEDs/each optic 1  
 Light colour White  
 Required components:

#### PHOTOMETRIC DATA (MEASURED):



LED NVSxx19A  
FWHM 43.0°  
Efficiency 91 %  
Peak intensity 1.700 cd/lm  
LEDs/each optic 1  
Light colour White  
Required components:

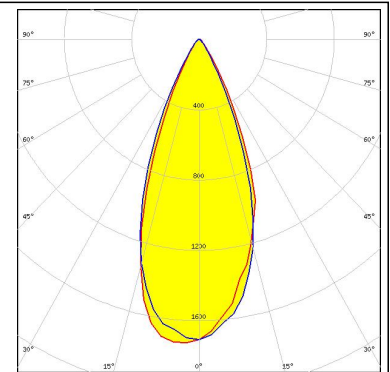
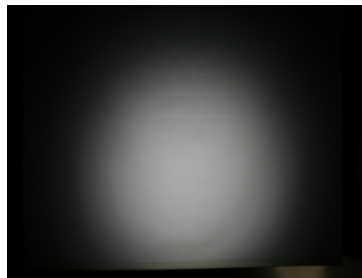

LED OSOLON Square EC  
FWHM 48.0°  
Efficiency 90 %  
Peak intensity 1.500 cd/lm  
LEDs/each optic 1  
Light colour White  
Required components:

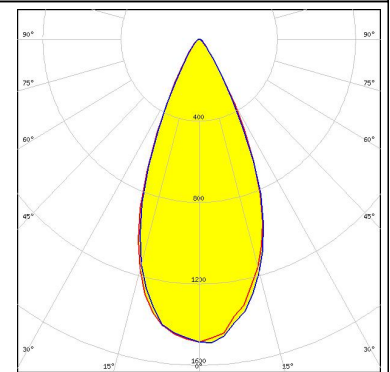
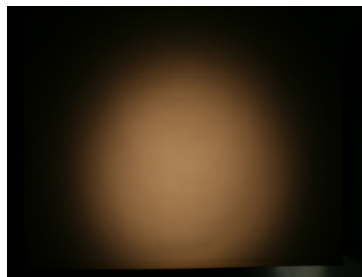

#### PHOTOMETRIC DATA (SIMULATED):

**CREE** 

LED XP-E  
FWHM 52.0°  
Efficiency 96 %  
Peak intensity 1.489 cd/lm  
LEDs/each optic 1  
Light colour White  
Required components:

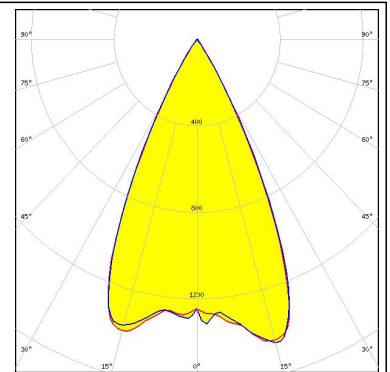

**NICHIA** 

LED NCSxx19A  
FWHM 44.0°  
Efficiency 95 %  
Peak intensity 1.855 cd/lm  
LEDs/each optic 1  
Light colour White  
Required components:

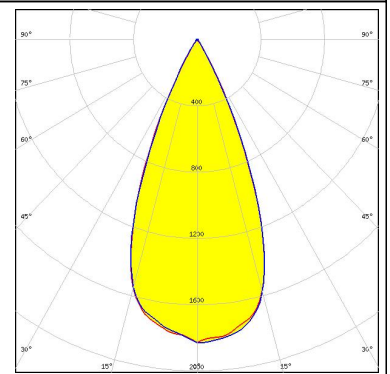

### GENERAL INFORMATION:

NOTE: The typical beam angle will be changed by different color, chip size and chip position tolerance. The typical total beam angle is the full angle measured where the luminous intensity is half of the peak value.

### MATERIALS:

As part of our continuous research and improvement processes, and to ensure the best possible quality and availability of our products, LEDiL reserves the right to change material grades without notice.

### PRODUCT DATA USER AGREEMENT AND DISCLAIMER:

The measured data in the provided downloadable LEDiL Product Datasheets and Mechanical 2D-Drawings is rounded and provided as reference for planning. LEDiL Oy's optical specifications have been verified by conducting performance testing of the products in accordance with the company's quality system. The reported data are averaged results of multiple measurements with typical variation. LEDiL Oy reserves the right to without prior notification make changes and improvements to its products.

LEDiL Oy assumes neither warranty, nor guarantee nor any other liability of any kind for the contents and correctness of the provided data. The provided data has been generated with highest diligence but the provided data may in reality not represent the complete possible variation range of all intrinsic parameters. Therefore, in certain cases a deviation from the provided data could occur.

LEDiL Oy reserves the right to undertake technical changes of its products without further notification which could lead to changes in the provided data. LEDiL Oy assumes no liability of any kind for the possible deviation from any provided data or any other damage resulting from the usage of the provided data.

The user agrees to this disclaimer and user agreement with the download or usage of the provided files.

#### LEDiL Oy

Joensuunkatu 13  
FI-24240 SALO  
Finland

#### LEDiL Inc.

228 West Page Street  
Suite D  
Sycamore IL 60178  
USA

#### Local sales and technical support

[www.ledil.com/  
where\\_to\\_buy](http://www.ledil.com/where_to_buy)

#### Shipping locations

Salo, Finland  
Hong Kong, China

#### Distribution Partners

[www.ledil.com/  
where\\_to\\_buy](http://www.ledil.com/where_to_buy)

Компания «Life Electronics» занимается поставками электронных компонентов импортного и отечественного производства от производителей и со складов крупных дистрибьюторов Европы, Америки и Азии.

С конца 2013 года компания активно расширяет линейку поставок компонентов по направлению коаксиальный кабель, кварцевые генераторы и конденсаторы (керамические, пленочные, электролитические), за счёт заключения дистрибьюторских договоров

Мы предлагаем:

- Конкуренспособные цены и скидки постоянным клиентам.
- Специальные условия для постоянных клиентов.
- Подбор аналогов.
- Поставку компонентов в любых объемах, удовлетворяющих вашим потребностям.
- Приемлемые сроки поставки, возможна ускоренная поставка.
- Доставку товара в любую точку России и стран СНГ.
- Комплексную поставку.
- Работу по проектам и поставку образцов.
- Формирование склада под заказчика.
- Сертификаты соответствия на поставляемую продукцию (по желанию клиента).
- Тестирование поставляемой продукции.
- Поставку компонентов, требующих военную и космическую приемку.
- Входной контроль качества.
- Наличие сертификата ISO.

В составе нашей компании организован Конструкторский отдел, призванный помогать разработчикам, и инженерам.

Конструкторский отдел помогает осуществить:

- Регистрацию проекта у производителя компонентов.
- Техническую поддержку проекта.
- Защиту от снятия компонента с производства.
- Оценку стоимости проекта по компонентам.
- Изготовление тестовой платы монтаж и пусконаладочные работы.



Тел: +7 (812) 336 43 04 (многоканальный)

Email: [org@lifeelectronics.ru](mailto:org@lifeelectronics.ru)