

# Ultra High Precision Foil Wraparound Surface Mount Chip Resistor with TCR of $\pm 0.05$ ppm/°C and Power Coefficient of 5 ppm at Rated Power and Load Life Stability of $\pm 0.005$ % (50 ppm)



Top View  
(for date code print specification please refer to table 2)

## INTRODUCTION

VSMP Series is the industry's first device to provide high rated power and excellent load life stability along with extremely low TCR — all in one resistor.

One of the most important parameters influencing stability is the Temperature Coefficient of Resistance (TCR). Although the TCR of foil resistors is considered extremely low, this characteristic has been further refined over the years. The VSMP Series utilizes ultra high precision Bulk Metal® Z-Foil. The Z-Foil technology provides a significant reduction of the resistive element's sensitivity to ambient temperature variations (TCR) and to self heating when power is applied (Power Coefficient of Resistance, or PCR). Along with the inherently low PCR and TCR, Z-Foil technology also provides remarkably improved load life stability, low noise and tight tolerances.

The VSMP resistor has a full wraparound termination which assures secure contact during the manufacturing process, as well as providing stability during multiple thermal cyclings.

Vishay Foil Resistors' (VFR) application engineering department is available to advise and make recommendations. For non-standard technical requirements and special applications, please contact VFR using the e-mail address in the footer below.

TABLE 1 - TOLERANCE AND TCR VS. RESISTANCE VALUE (1) (- 55 °C to + 125 °C, + 25 °C Ref.)		
RESISTANCE VALUE (Ω)	TOLERANCE (%)	TYPICAL TCR AND MAX. SPREAD (ppm/°C)
250 to 125K	± 0.01	± 0.2 ± 1.8
100 to < 250	± 0.02	± 0.2 ± 1.8
50 to < 100	± 0.05	± 0.2 ± 2.8
25 to < 50	± 0.1	± 0.2 ± 3.8
10 to < 25	± 0.25	± 0.2 ± 3.8
5 to < 10	± 0.5	± 0.2 ± 7.8

### Note

(1) For tighter performances and non-standard values lower than 5 Ω and above 125K, please contact VFR's application engineering using the e-mail addresses in the footer below

## FEATURES

- Temperature coefficient of resistance (TCR):  
0.05 ppm/°C typical (0 °C to + 60 °C)  
0.2 ppm/°C typical (- 55 °C to + 125 °C, + 25 °C ref.)
- Resistance tolerance: to ± 0.01 %
- Power coefficient "ΔR due to self heating":  
5 ppm at rated power
- Power rating: to 750 mW at + 70 °C (see table 3)
- **Load life stability: to ± 0.005 % at 70 °C, 2000 h at rated power**
- Resistance range: 5 Ω to 125 kΩ (for lower or higher values, please contact us)
- Vishay Foil resistors are not restricted to standard values, we can supply specific "as required" values at no extra cost or delivery (e.g. 1K2345 vs. 1K)
- Thermal stabilization time < 1 s (nominal value achieved within 10 ppm of steady state value)
- **Electrostatic discharge (ESD) at least to 25 kV**
- Short time overload: ≤ 0.005 %
- Non inductive, non capacitive design
- Rise time: 1 ns effectively no ringing
- Current noise: 0.010 μV<sub>RMS</sub>/V of applied voltage (< - 40 dB)
- Voltage coefficient < 0.1 ppm/V
- Non inductive: < 0.08 μH
- Non hot spot design
- Terminal finishes available: lead (Pb)-free, tin/lead alloy
- Matched sets are available on request
- Prototype quantities available in just 5 working days or sooner. For more information, please contact [foil@vishaypg.com](mailto:foil@vishaypg.com)



RoHS\*  
COMPLIANT

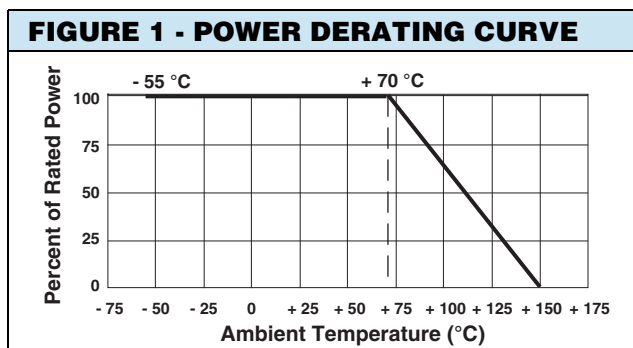

\* Pb containing terminations are not RoHS compliant; exemptions may apply

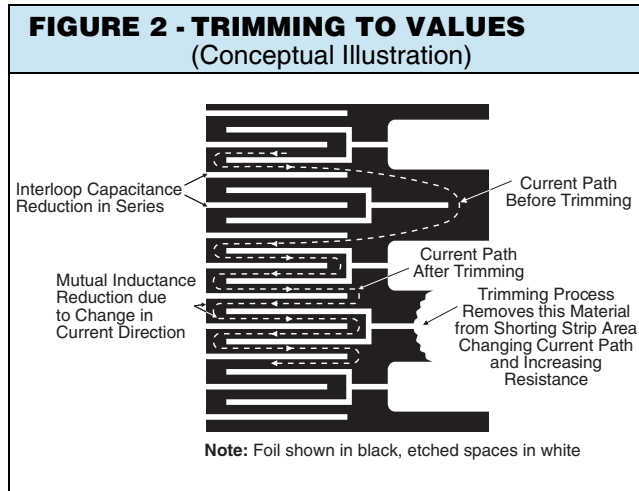

**Note**

- The TCR values for  $< 100 \Omega$  are influenced by the termination composition and result in deviation from this curve

**TABLE 2 - DIMENSIONS AND LAND PATTERN** in Inches (Millimeters)

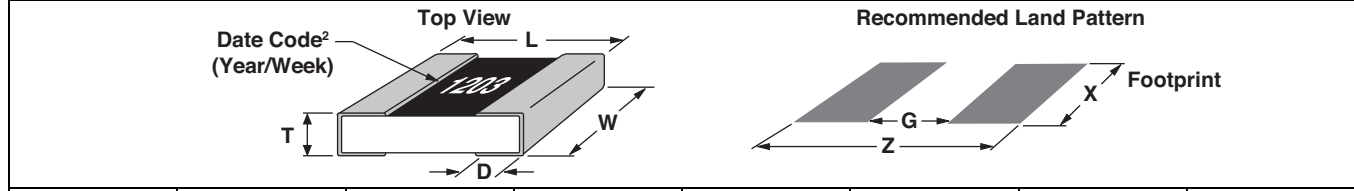

CHIP SIZE	L ± 0.005 (0.13)	W ± 0.005 (0.13)	THICKNESS MAXIMUM	D ± 0.005 (0.13)	Z <sup>(1)</sup>	G <sup>(1)</sup>	X <sup>(1)</sup>
0603	0.063 (1.60)	0.032 (0.81)	0.025 (0.64)	0.011 (0.28)	0.102 (2.59)	0.031 (0.78)	0.031(0.78)
0805	0.080 (2.03)	0.050 (1.27)	0.025 (0.64)	0.015 (0.38)	0.122 (3.10)	0.028 (0.71)	0.050 (1.27)
1206	0.126 (3.20)	0.062 (1.57)	0.025 (0.64)	0.020 (0.51)	0.175 (4.45)	0.059 (1.50)	0.071 (1.80)
1506	0.150 (3.81)	0.062 (1.57)	0.025 (0.64)	0.020 (0.51)	0.199 (5.05)	0.083 (2.11)	0.071 (1.80)
2010	0.198 (5.03)	0.097 (2.46)	0.025 (0.64)	0.025 (0.64)	0.247 (6.27)	0.115 (2.92)	0.103 (2.62)
2018	0.204 (5.18)	0.184 (4.67)	0.025 (0.64)	0.018 (0.46)	0.248 (6.3)	0.146 (3.71)	0.184 (4.67)
2512	0.249 (6.32)	0.127 (3.23)	0.025 (0.64)	0.032 (0.81)	0.291 (7.39)	0.150 (3.81)	0.127 (3.23)

**Note**

(1) Land Pattern Dimensions are per IPC-7351A

(2) The date code printing applies to all resistor sizes except for 0603

**TABLE 3 - SPECIFICATIONS**

CHIP SIZE	RATED POWER (mW) at + 70 °C	MAX. WORKING VOLTAGE (≤ √P × R)	RESISTANCE RANGE (Ω)*	MAXIMUM WEIGHT (mg)
0603	100	20 V	100 to 4K	3
0805	200	40 V	5 to 8K	6
1206	300	87 V	5 to 25K	11
1506	300	95 V	5 to 30K	12
2010	500	187 V	5 to 70K	27
2018	750	122 V	5 to 20K	40
2512	750	220 V	5 to 125K	40

\* For non standard values please contact VFR's application engineering using the e-mail addresses in the footer below.

**TABLE 4 - LOAD LIFE STABILITY**  
(+ 70 °C for 2000 h)

CHIP SIZE	MAXIMUM ΔR LIMITS
0603	± 0.005 % at 50 mW ± 0.01 % at 100 mW
0805	± 0.005 % at 100 mW ± 0.01 % at 200 mW
1206, 1506	± 0.005 % at 150 mW ± 0.01 % at 300 mW
2010	± 0.005 % at 200 mW ± 0.01 % at 500 mW
2018	± 0.005 % at 500 mW ± 0.01 % at 750 mW
2512	± 0.005 % at 500 mW ± 0.01 % at 750 mW

**TABLE 5 - PERFORMANCES**

TEST OR CONDITIONS	MIL-PRF-55342 CHARACTERISTIC E $\Delta R$ LIMITS	TYPICAL $\Delta R$ LIMITS	MAXIMUM $\Delta R$ LIMITS <sup>(1)</sup>
Thermal Shock, 100 x (- 65 °C to + 150 °C)	± 0.1 %	± 0.005 % (50 ppm)	± 0.01 % (100 ppm)
Low Temperature Operation, - 65 °C, 45 min at P <sub>nom</sub>	± 0.1 %	± 0.005 % (50 ppm)	± 0.01 % (100 ppm)
Short Time Overload, 6.25 x Rated Power, 5 s	± 0.1 %	± 0.005 % (50 ppm)	± 0.01 % (100 ppm)
High Temperature Exposure, + 150 °C, 100 h	± 0.1 %	± 0.01 % (100 ppm)	± 0.02 % (200 ppm)
Resistance to Soldering Heat	± 0.2 %	± 0.005 % (50 ppm)	± 0.01 % (100 ppm)
Moisture Resistance	± 0.2 %	± 0.005 % (50 ppm)	± 0.02 % (200 ppm)
Load Life Stability + 70 °C for 2000 h at Rated Power	± 0.5 %	± 0.005 % (50 ppm)	± 0.01 % (100 ppm)

**Note**

(1) As shown + 0.01  $\Omega$  to allow for measurement errors at low values

**FIGURE 4 - RECOMMENDED MOUNTING**

**Notes**

- (1) IR and vapor phase reflow are recommended.
- (2) Avoid the use of cleaning agents which could attack epoxy resins, which form part of the resistor construction
- (3) Vacuum pick up is recommended for handling
- (4) In case of using soldering iron, precaution measures should be taken to avoid damaging the resistor

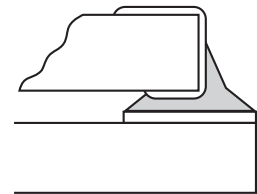

**FIGURE 5 - VSMP0603 100 CYCLE THERMAL SHOCK - 65 °C TO 150 °C, 10 UNITS EACH VALUE**

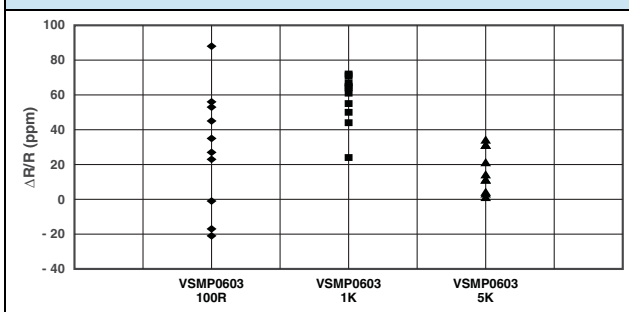

**FIGURE 6 - LOAD LIFE TEST FOR 10,000 HRS @0.3W, +70°C; VSMP 1206, N=40**

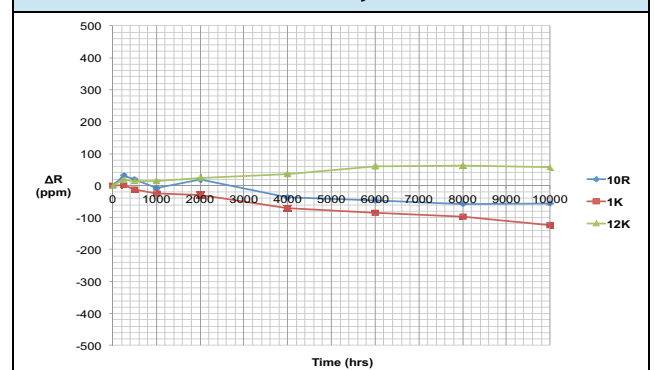

**CRYOGENIC TEST**

Different expansion/contraction rates of composite materials in resistors may induce discontinuities during temperature excursions that are not evident at temperature extremes, making an unreliable resistor appear normal. A good resistor must also return to its initial value with no resistance drift. In this demo, a VFR VSMP0805 precision resistor is monitored through the range of +25°C, down to -196°C and back up to +25°C. Results confirm the VSMP0805 exhibits only 5 ppm/°C TCR, experiences no discontinuities, and returns to its exact same starting value, showing absolutely no change in resistance (< 1 ppm measurement accuracy).

**FIGURE 7 - PRECISION RESISTOR IN CRYOGENIC CONDITIONS - ONLY 5 PPM/°C (PRODUCT DEMO)**



**PULSE TEST**

**TEST DESCRIPTION**

All parts are baked at +125°C for 1 hour and allowed to cool at room temperature for 1 hour, prior to testing. By using an electrolytic 0.01µF capacitor charged to 1200 VDC, a single pulse was performed on 30 units of 1206, 10 kΩ of Surface Mount Vishay Foil resistor and Thin Film resistor. The units were allowed time to cool down, after which the resistance measurements were taken and displayed in ppm deviation from the initial reading.

**TEST RESULTS**

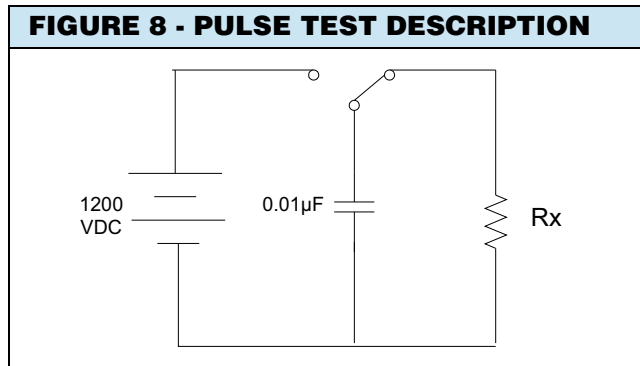

**FIGURE 9 - PULSE TEST RESULTS AT 1200 VDC\***

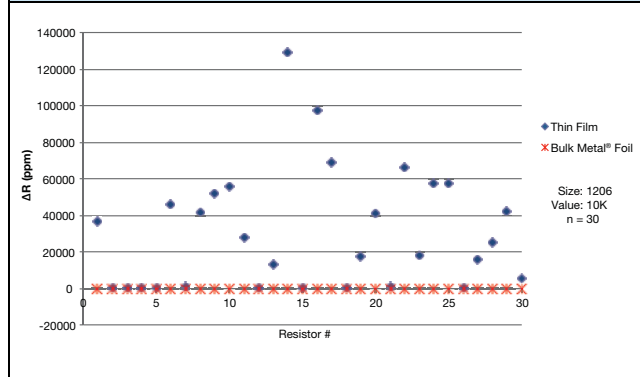

\* Note: Average of 30 units yielded deviation of 30,723 ppm of the Thin Film vs. -14 ppm for the Bulk Metal<sup>®</sup> Foil

**ELECTROSTATIC DISCHARGE (ESD)**

ESD can be categorized into three types of damages:

**Parametric Failure** - occurs when the ESD event alters one or more device parameters (resistance in the case of resistors), causing it to shift from its required tolerance. This failure does not directly pertain to functionality; thus a parametric failure may be present while the device is still functional.

**Catastrophic Damage** - occurs when the ESD event causes the device to immediately stop functioning. This may occur after one or a number of ESD events with diverse causes, such as human body discharge or the mere presence of an electrostatic field.

**Latent Damage** - occurs when the ESD event causes moderate damage to the device, which is not noticeable, as the device appears to be functioning correctly. However, the load life of the device has been dramatically reduced, and further degradation caused by operating stresses may cause the device to fail during service. Latent damage is the source for greatest concern, since it is very difficult to detect by re-measurement or by visual inspection, because damage may have occurred under the external coating.

**TEST DESCRIPTION**

By using an electrolytic 500 pF capacitor charged up to 4500 V, pulses were performed on 10 units of 1206, 10 kΩ of three different Surface Mount Chip Resistors technologies, with an initial voltage spike of 2500 V (Figure 10). The units were allowed time to cool down, after which the resistance measurements were taken and displayed in ppm deviation from the initial readings. Readings were then taken in 500 V increments up to 4500 V.

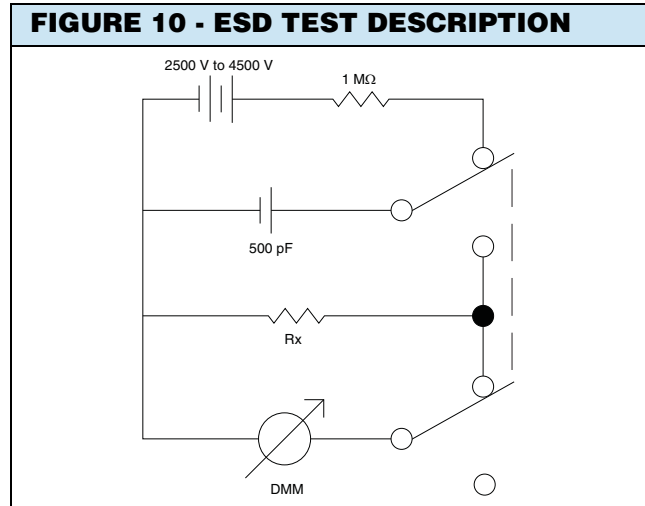

**TABLE 6 - ESD TEST RESULTS (AVERAGE OF 10 UNITS)**

VOLTS	ΔR (%)		
	THICK FILM	THIN FILM	FOIL
2500	-2.7	97	<0.005
3000	-4.2	366	<0.005
3500	-6.2	OPEN	<0.005
4000	-7.4	OPEN	<0.005
4500	-8.6	OPEN	<0.005

**TABLE 7- GLOBAL PART NUMBER INFORMATION (1)**

NEW GLOBAL PART NUMBER: Y162612K7560T9R (preferred part number format)



FOR EXAMPLE: ABOVE GLOBAL ORDER Y1626 12K7560 T 9 R:

TYPE: VSMP1506  
VALUES: 12.7560 kΩ  
ABSOLUTE TOLERANCE: 0.01 %  
TERMINATION: lead (Pb)-free  
PACKAGING: tape and reel

HISTORICAL PART NUMBER: VSMP1506 12K756 TCR0.2 T S T (will continue to be used)

VSMP1506	12K756	TCR0.2	T	S	T
MODEL	RESISTANCE VALUE	TCR CHARACTERISTICS	TOLERANCE	TERMINATION	PACKAGING
VSMP0603 VSMP0805 VSMP1206 VSMP1506 VSMP2010 VSMP2018 VSMP2512	12.756 kΩ		T = ± 0.01 % Q = ± 0.02 % A = ± 0.05 % B = ± 0.10 % C = ± 0.25 % D = ± 0.5 % F = ± 1.0 %	S = lead (Pb)-free B = tin/lead	T = tape and reel W = waffle pack

**Note**

(1) For non-standard requests, please contact application engineering.

**PRECISION CENTER**

Precision centers are located around the world to provide local, short run, quick delivery of Vishay Bulk Metal® Foil resistors. Unique to Vishay Foil Resistors (VFR) is the ability to provide any value to any tolerance. The precision centers can ship small quantities in five days or less.

Why do we have authorized local manufacturing or precision centers?

Because we have no standard values and each resistor is trimmed to the precise value ordered. The unique chain of Precision Centers brings these precise values as close as possible to the circuit designers in the shortest time possible.

For your local Precision Center please click [here](#).

## Disclaimer

ALL PRODUCTS, PRODUCT SPECIFICATIONS AND DATA ARE SUBJECT TO CHANGE WITHOUT NOTICE.

Vishay Precision Group, Inc., its affiliates, agents, and employees, and all persons acting on its or their behalf (collectively, "Vishay Precision Group"), disclaim any and all liability for any errors, inaccuracies or incompleteness contained herein or in any other disclosure relating to any product.

The product specifications do not expand or otherwise modify Vishay Precision Group's terms and conditions of purchase, including but not limited to, the warranty expressed therein.

Vishay Precision Group makes no warranty, representation or guarantee other than as set forth in the terms and conditions of purchase. **To the maximum extent permitted by applicable law, Vishay Precision Group disclaims (i) any and all liability arising out of the application or use of any product, (ii) any and all liability, including without limitation special, consequential or incidental damages, and (iii) any and all implied warranties, including warranties of fitness for particular purpose, non-infringement and merchantability.**

Information provided in datasheets and/or specifications may vary from actual results in different applications and performance may vary over time. Statements regarding the suitability of products for certain types of applications are based on Vishay Precision Group's knowledge of typical requirements that are often placed on Vishay Precision Group products. It is the customer's responsibility to validate that a particular product with the properties described in the product specification is suitable for use in a particular application.

No license, express, implied, or otherwise, to any intellectual property rights is granted by this document, or by any conduct of Vishay Precision Group.

The products shown herein are not designed for use in life-saving or life-sustaining applications unless otherwise expressly indicated. Customers using or selling Vishay Precision Group products not expressly indicated for use in such applications do so entirely at their own risk and agree to fully indemnify Vishay Precision Group for any damages arising or resulting from such use or sale. Please contact authorized Vishay Precision Group personnel to obtain written terms and conditions regarding products designed for such applications.

Product names and markings noted herein may be trademarks of their respective owners.

Компания «Life Electronics» занимается поставками электронных компонентов импортного и отечественного производства от производителей и со складов крупных дистрибьюторов Европы, Америки и Азии.

С конца 2013 года компания активно расширяет линейку поставок компонентов по направлению коаксиальный кабель, кварцевые генераторы и конденсаторы (керамические, пленочные, электролитические), за счёт заключения дистрибьюторских договоров

Мы предлагаем:

- Конкурентоспособные цены и скидки постоянным клиентам.
- Специальные условия для постоянных клиентов.
- Подбор аналогов.
- Поставку компонентов в любых объемах, удовлетворяющих вашим потребностям.
- Приемлемые сроки поставки, возможна ускоренная поставка.
- Доставку товара в любую точку России и стран СНГ.
- Комплексную поставку.
- Работу по проектам и поставку образцов.
- Формирование склада под заказчика.
- Сертификаты соответствия на поставляемую продукцию (по желанию клиента).
- Тестирование поставляемой продукции.
- Поставку компонентов, требующих военную и космическую приемку.
- Входной контроль качества.
- Наличие сертификата ISO.

В составе нашей компании организован Конструкторский отдел, призванный помогать разработчикам, и инженерам.

Конструкторский отдел помогает осуществить:

- Регистрацию проекта у производителя компонентов.
- Техническую поддержку проекта.
- Защиту от снятия компонента с производства.
- Оценку стоимости проекта по компонентам.
- Изготовление тестовой платы монтаж и пусконаладочные работы.



Тел: +7 (812) 336 43 04 (многоканальный)

Email: [org@lifeelectronics.ru](mailto:org@lifeelectronics.ru)