

LOC		DIST		REVISIONS			
P	LTN	DESCRIPTION	DATE	DWN	APVD		
	H4	ADDED DASH NUMBER -33	25FEB2013	CZ	SZ		

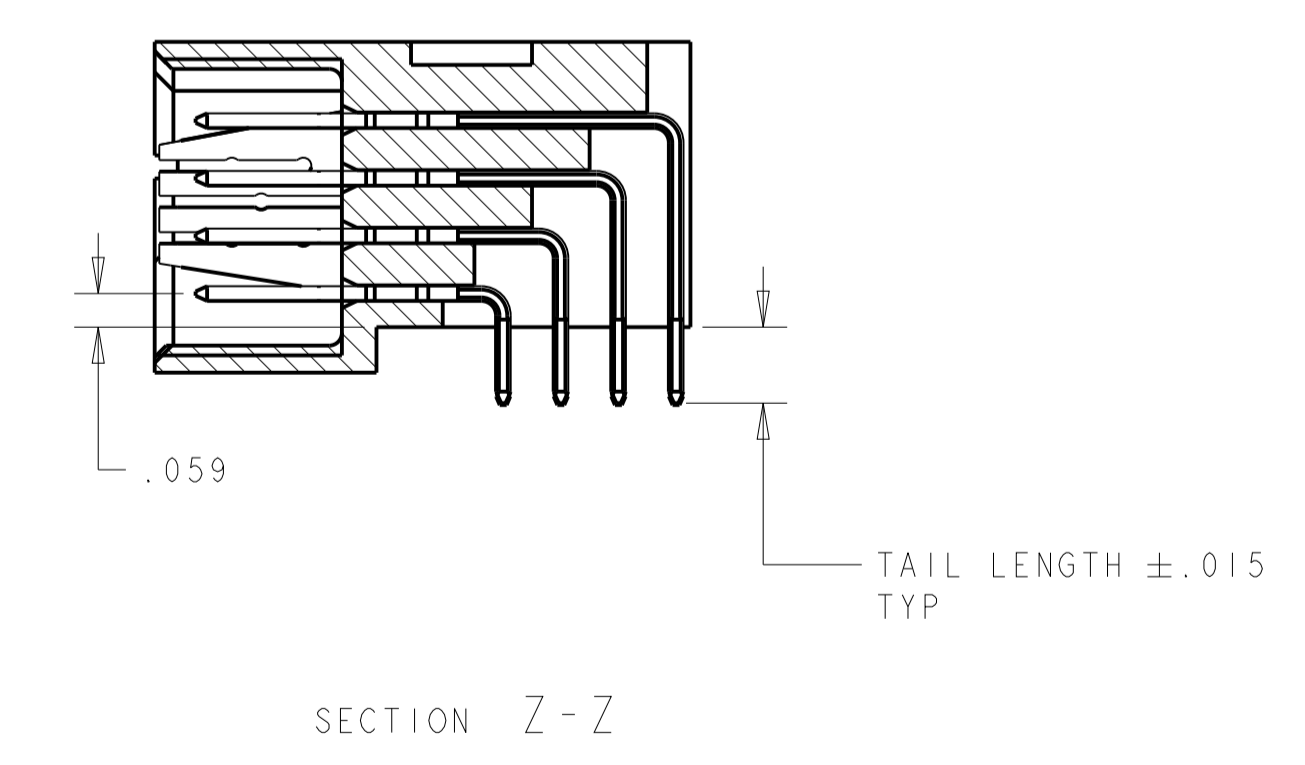
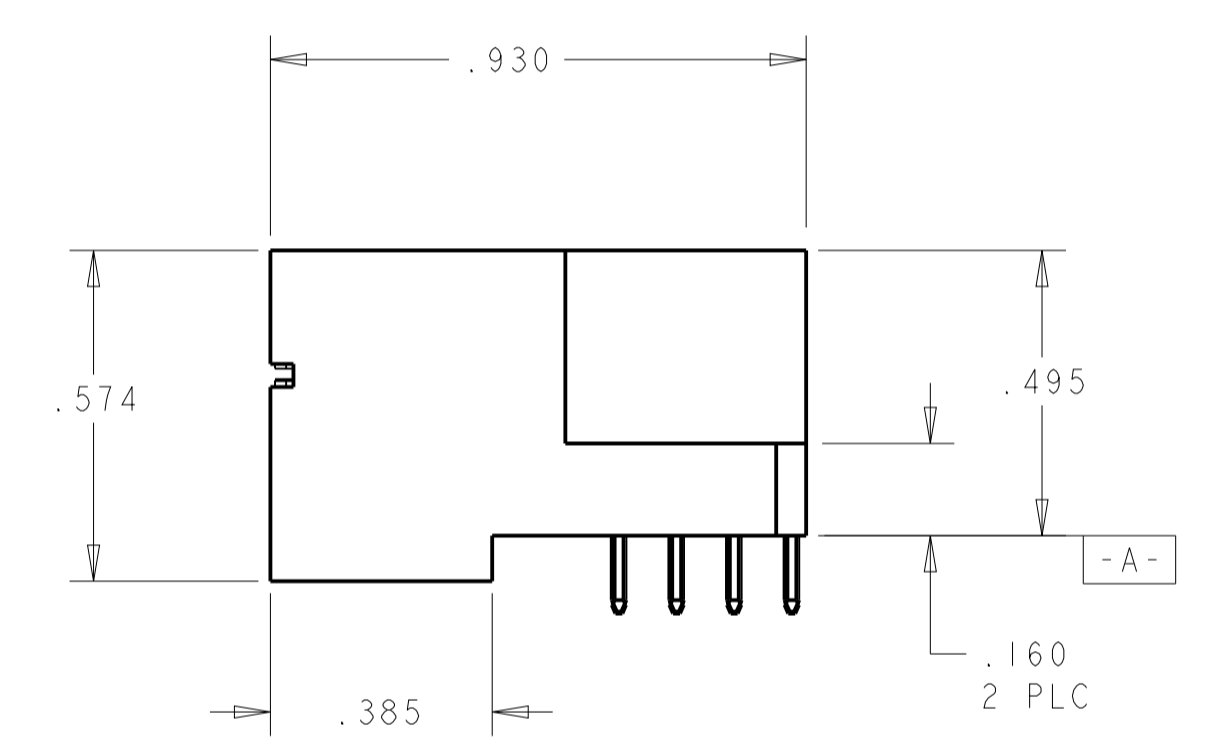
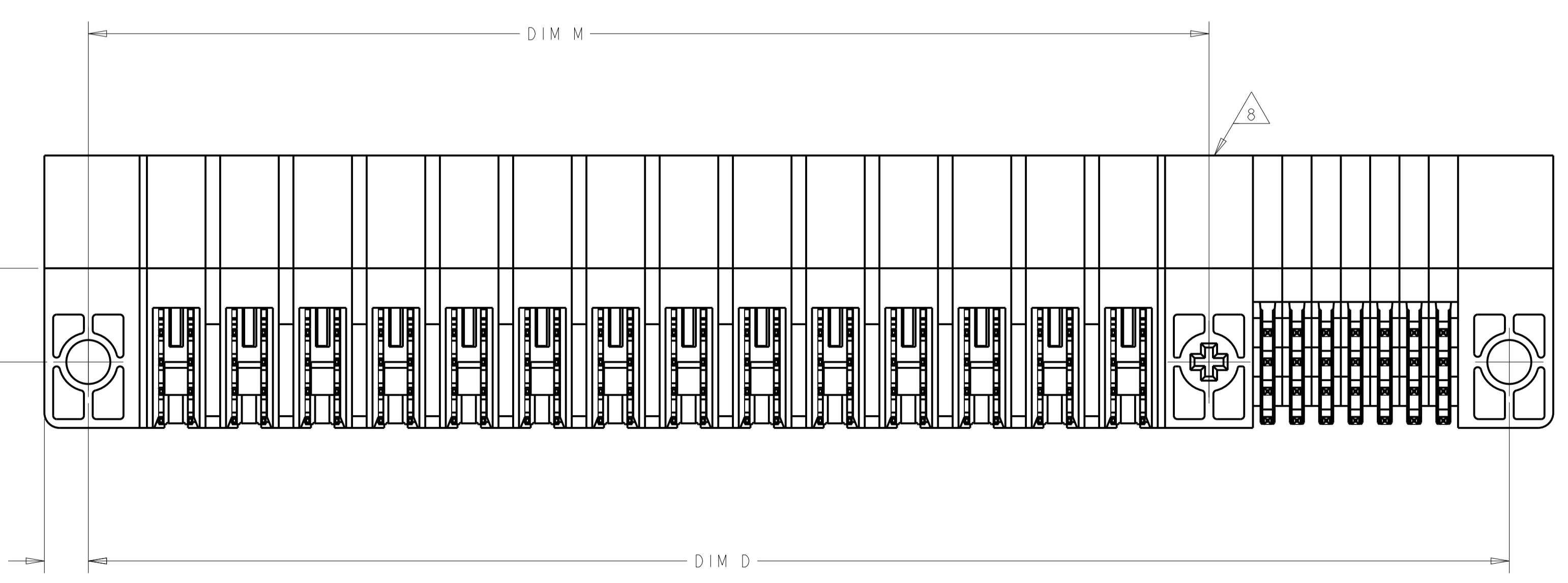
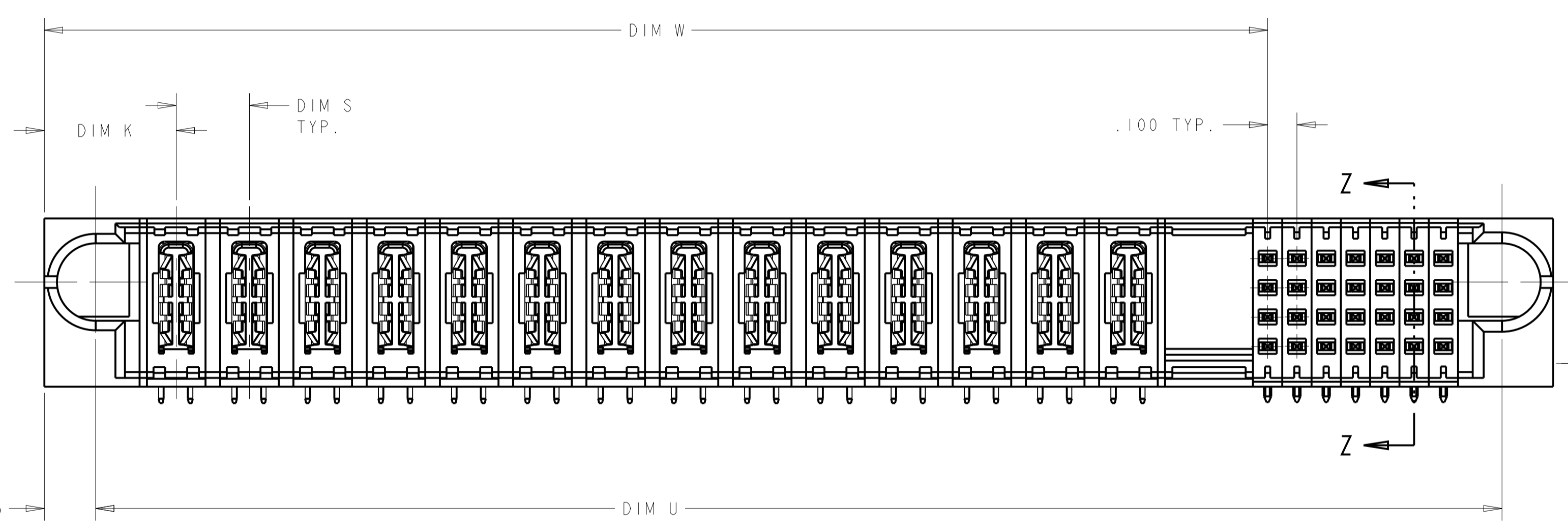
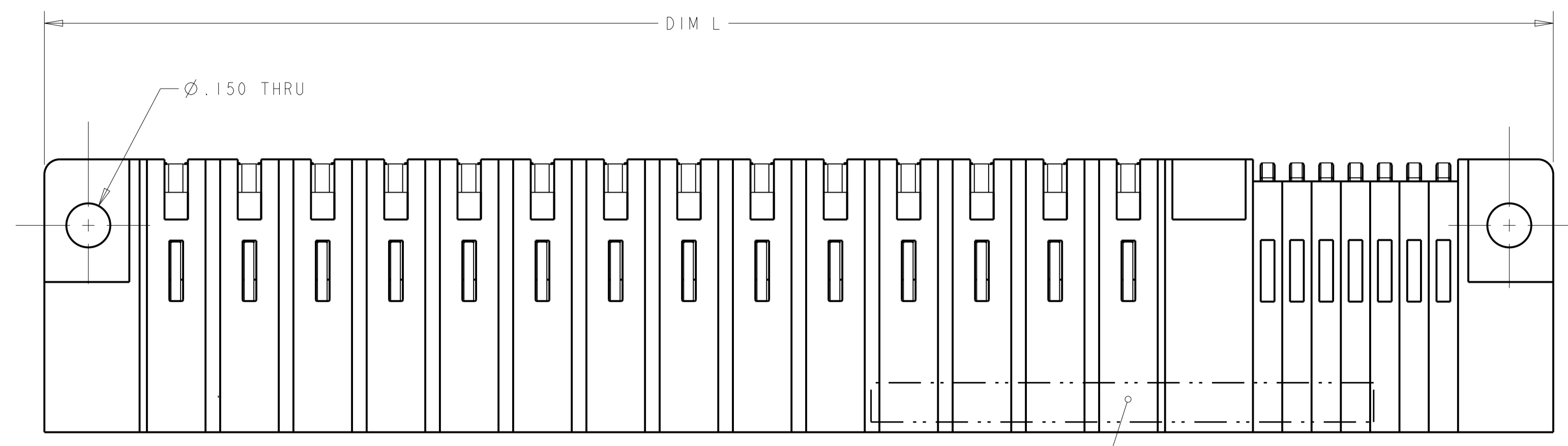

THIS DRAWING IS A CONTROLLED DOCUMENT.		DWN R. GRZYBOWSKI CHK M. PERCHERKE	24JAN05	TE Connectivity RIGHT ANGLE SOLDER HEADER ASSEMBLY MULTI-BEAM XL	
DIMENSIONS: INCHES		APVD M. PERCHERKE			
TOLERANCES UNLESS OTHERWISE SPECIFIED:		PRODUCT SPEC		SIZE	RESTRICTED TO
0 PLC ±.01		108-1973		CAGE CODE	DRAWING NO
1 PLC ±.01		APPLICATION SPEC		A100779	6450332
2 PLC ±.005		WEIGHT		SCALE 4:1 SHEET 1 OF 13 REV H6	
3 PLC ±.002		CUSTOMER DRAWING			
ANGLES ±.020					
FINISH					

LOC	DIST	REVISIONS			
		REV	DATE	BY	APPV
ES	00				

- 1 "AMP", PART NUMBER, AND DATECODE TO BE MARKED IN AREA SHOWN.
- 2 MATERIAL: HOUSING - GLASS FILLED HIGH TEMP THERMO PLASTIC, UL94 V-0
SIGNAL CONTACT - COPPER ALLOY
POWER CONTACT - HIGH CONDUCTIVITY COPPER ALLOY
- 3 CONTACT PLATING: NOBLE METAL PLATING ON CONTACT FUNCTIONAL AREA OF POWER AND SIGNAL CONTACTS
- 4 MECHANICAL CONNECTOR KEEP OUT ZONE.
- 5 DATUM AND BASIC DIMENSIONS ESTABLISHED BY CUSTOMER.
- 6 PCB - HOLE DIAMETERS ARE FINISHED HOLE SIZE.
- 7 PCB - .0453±.0010 DRILLED HOLES PLATED WITH .0003 MIN Sn OVER .001 TO .003 Cu PLATING TO ACHIEVE A .040 DIAMETER HOLE.
- 8 OPTIONAL CENTER MODULE
- 9 NOT RELEASED FOR PRODUCTION
- 10 VARIABLE DIMENSIONS SHOWN ON TABLE

DIM U	DIM S	DIM W	DIM D	DIM M	DIM L	DIM K	DESCRIPTION	PART NUMBER
1.900	.250	1.375	1.950	-	2.250	.450	4P + 24S	3-6450332-4
2.825	△	2.300	2.875	-	3.175	.475	3ACP + 4P + 24S	3-6450332-3
1.600	.250	1.375	1.650	-	1.950	.450	4P + 12S	3-6450332-2
2.825	△	2.300	2.875	-	3.175	.475	3ACP + 4P + 24S	3-6450332-1
3.225	△	2.675	3.275	-	3.575	.525	9P + 24S	3-6450332-0
2.700	△	2.275	2.750	-	3.050	.450	4ACP+3P+20S	1-6450332-9
3.225	△	2.675	3.275	-	3.575	.525	3ACP+6P+24S	2-6450332-8
1.650	.200	1.225	1.700	-	2.000	.450	4P + 20S	2-6450332-6
1.800	△	1.275	1.850	-	2.150	.450	4P + 24S	2-6450332-5
2.900	.250	2.375	2.950	-	3.250	.450	8P + 24S	2-6450332-4
3.225	△	2.675	3.275	-	3.575	.525	3ACP+6P+24S	2-6450332-3
2.150	.250	1.625	2.200	-	2.500	.450	5P + 24S	2-6450332-0
3.225	△	2.675	3.275	-	3.575	.525	3ACP+6P+24S	6450332-9
3.875	△	3.550	3.925	-	4.225	.475	1ACP + 9P + 16S	1-6450332-8
2.300	.250	1.875	2.350	-	2.650	.450	6P+20S	1-6450332-7
3.875	△	3.550	3.925	-	4.225	.475	3ACP+9P+16S	1-6450332-6
5.100	△	2.375	5.150	-	5.450	.450	8P + 112S	1-6450332-4
3.800	△	3.175	3.850	-	4.150	.450	12P + 28S	1-6450332-3
2.275	△	2.050	2.325	-	2.625	.450	5P + 24S	1-6450332-2
1.400	.250	.875	1.450	-	1.750	.450	2P + 24S	6450332-8
1.100	-	.575	1.150	-	1.450	.425	1P + 24S	6450332-6
4.425	.250	3.875	4.475	-	4.775	.450	14P + 24S	6450332-5
2.675	.250	2.125	2.725	-	3.025	.450	7P + 24S	6450332-4
2.925	.250	2.375	2.975	-	3.275	.450	8P + 24S	6450332-3
4.500	.250	3.875	4.550	-	4.850	.450	14P + 28S	6450332-2

THIS DRAWING IS A CONTROLLED DOCUMENT.

OWN: R. GRZYBOWSKI 24JAN05
CHK: M. PERCHERKE 24JAN05
APPV: M. PERCHERKE

STE TE Connectivity

NAME: RIGHT ANGLE SOLDER HEADER ASSEMBLY MULTI-BEAM XL

PRODUCT SPEC: 108-1973
APPLICATION SPEC: 114-13038

SIZE: A1 CAGE CODE: 6450332 DRAWING NO: 100779

RESTRICTED TO: -

MATERIAL: - FINISH: - WEIGHT: -

CUSTOMER DRAWING SCALE: 4:1 SHEET 2 OF 13 REV: H6

LOC	DIST	REV	DATE	APPV
ES	00			

ASSY PART NUMBER	ROWS	POWER														SIGNAL						
		P1	P2	P3	P4	P5	P6	P7	P8	P9	P10	P11	P12	P13	P14	1	2	3	4	5	6	7
6450332-2	D C B A	PM	PM	PM	PM	PM	PM	PM	PM	PM	PM	PM	PM	PM	E	E	E	E	E	E	E	E
14P + 28S															F	F	F	F	F	F	F	F
															G	G	G	G	G	G	G	G
															S	S	S	S	S	H	H	H

PART NUMBER	ROWS	POWER								SIGNAL					
		P1	P2	P3	P4	P5	P6	P7	P8	1	2	3	4	5	6
6450332-3	D C B A	PM	PM	PM	PM	PM	PM	PM	PM	J	J	J	J	E	E
8P + 24S										K	K	K	K	F	F
										N	N	N	N	G	G
										S	S	S	S	H	H

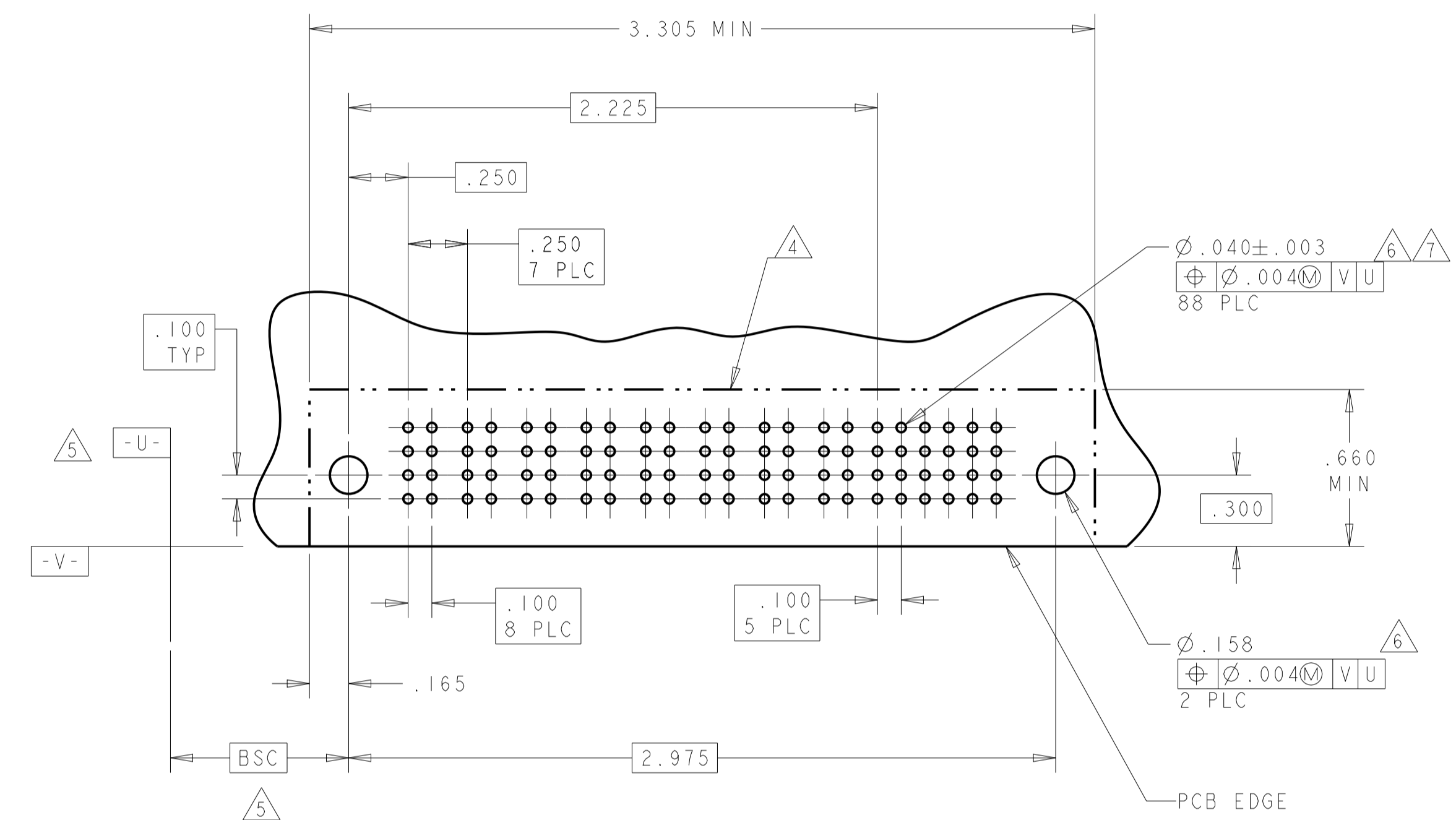
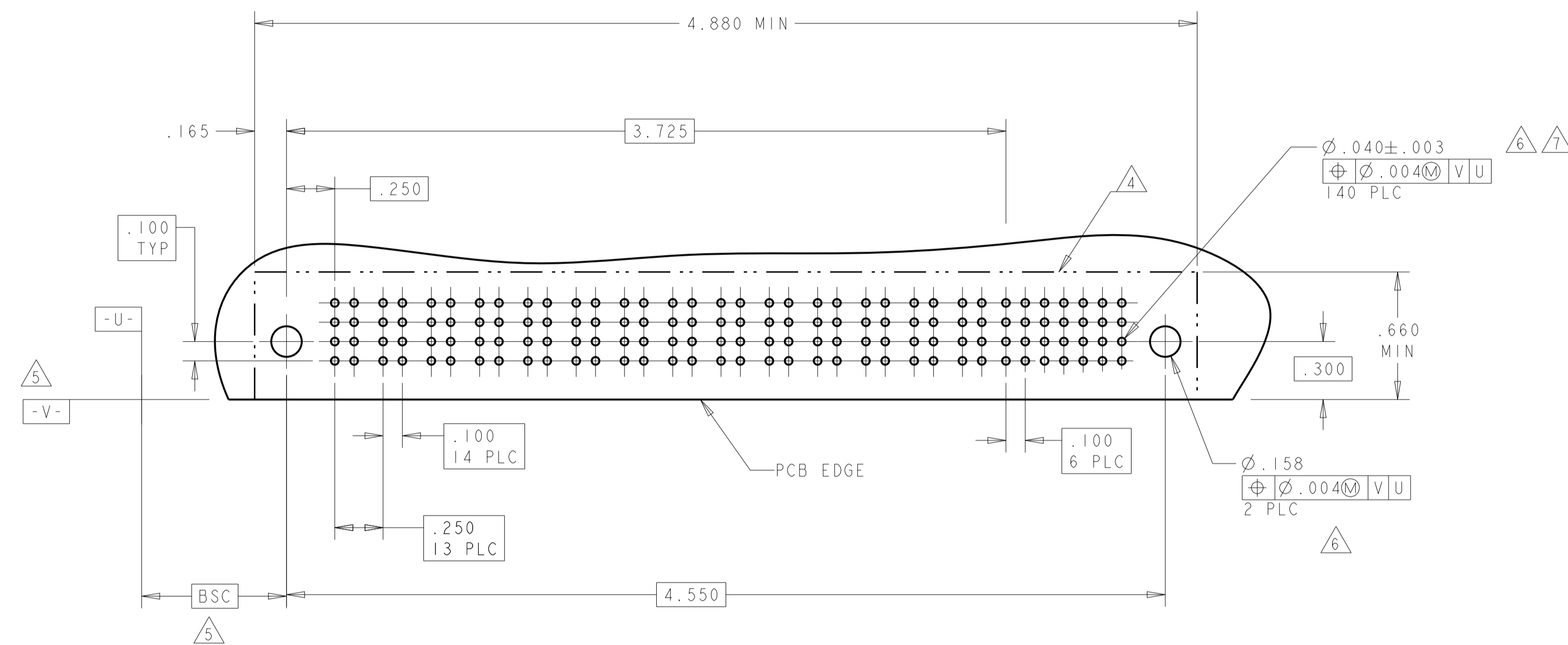

PART NUMBER	ROWS	POWER							SIGNAL					
		P1	P2	P3	P4	P5	P6	P7	1	2	3	4	5	6
6450332-4	D C B A	PM	PM	PM	PM	PM	PM	PM	J	J	E	J	J	J
7P + 24S									K	K	K	K	K	K
									N	N	N	N	N	N
									S	S	S	S	S	S

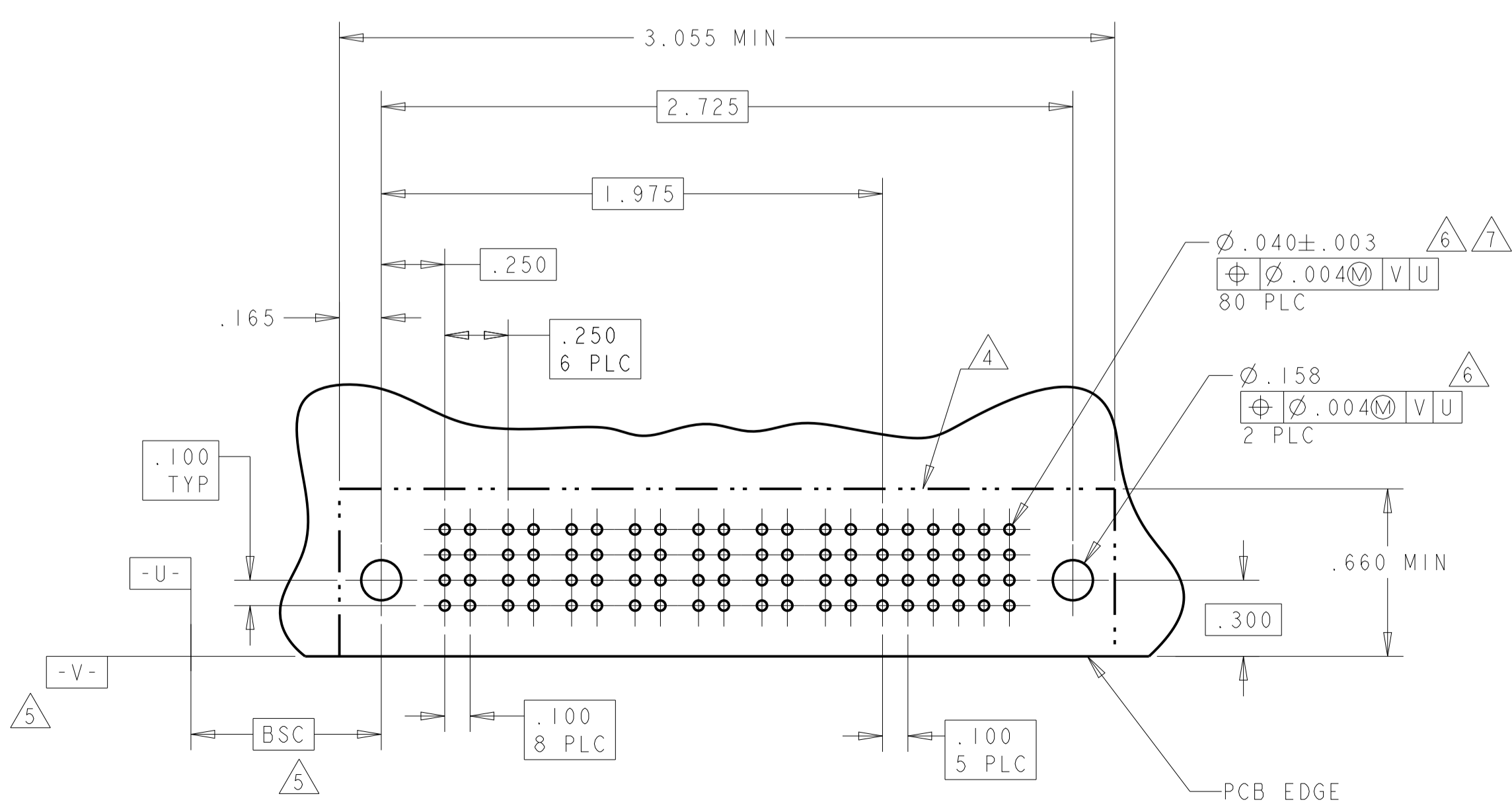

CODE	MATING SEQUENCE	TAIL LENGTH	ROW
Z	STD	.090	D
Y	STD	.090	C
R	STD	.090	B
O	STD	.090	A
A4	MLBF	.090	D
A3	MLBF	.090	C
A2	MLBF	.090	B
A1	MLBF	.090	A
E	MLBF	.135	D
F	MLBF	.135	C
G	MLBF	.135	B
H	MLBF	.135	A
J	STD	.135	D
K	STD	.135	C
N	STD	.135	B
S	STD	.135	A

CODE	TAIL LENGTH
PA	.090
PM	.135

THIS DRAWING IS A CONTROLLED DOCUMENT. **STE** TE Connectivity

APV: M. PERCHERKE
 PRODUCT SPEC: 108-1973
 APPLICATION SPEC: 114-13038
 WEIGHT: A100779
 CUSTOMER DRAWING: 6450332

SCALE: 4:1 SHEET 3 OF 13 REV: H6

LOC	DIST	REV	DATE	APPV
ES	00			

REVISIONS				
REV	DATE	APPV	DESCRIPTION	BY
-	-	-	SEE SHEET 1	-

PART NUMBER	ROWS	POWER														SIGNAL					
		P1	P2	P3	P4	P5	P6	P7	P8	P9	P10	P11	P12	P13	P14	1	2	3	4	5	6
6450332-5	D C B A	PM	PM	PM	PM	PM	PM	PM	PM	PM	PM	PM	PM	PM	PM	E	E	E	E	E	E
		PM	PM	PM	PM	PM	PM	PM	PM	PM	PM	PM	PM	PM	PM	F	F	F	F	F	F
		PM	PM	PM	PM	PM	PM	PM	PM	PM	PM	PM	PM	PM	PM	G	G	G	G	G	G
		PM	PM	PM	PM	PM	PM	PM	PM	PM	PM	PM	PM	PM	PM	H	H	S	S	H	H
14P + 24S																					

PART NUMBER	ROWS	POWER					SIGNAL					
		P1	P2	P3	P4	P5	1	2	3	4	5	6
1-6450332-2	D C B A	PM	PM	PM	PM	PM						
		PM	PM	PM	PM	PM				J	J	J
		PM	PM	PM	PM	PM				K	K	K
		PM	PM	PM	PM	PM				N	N	N
5P + 24S												

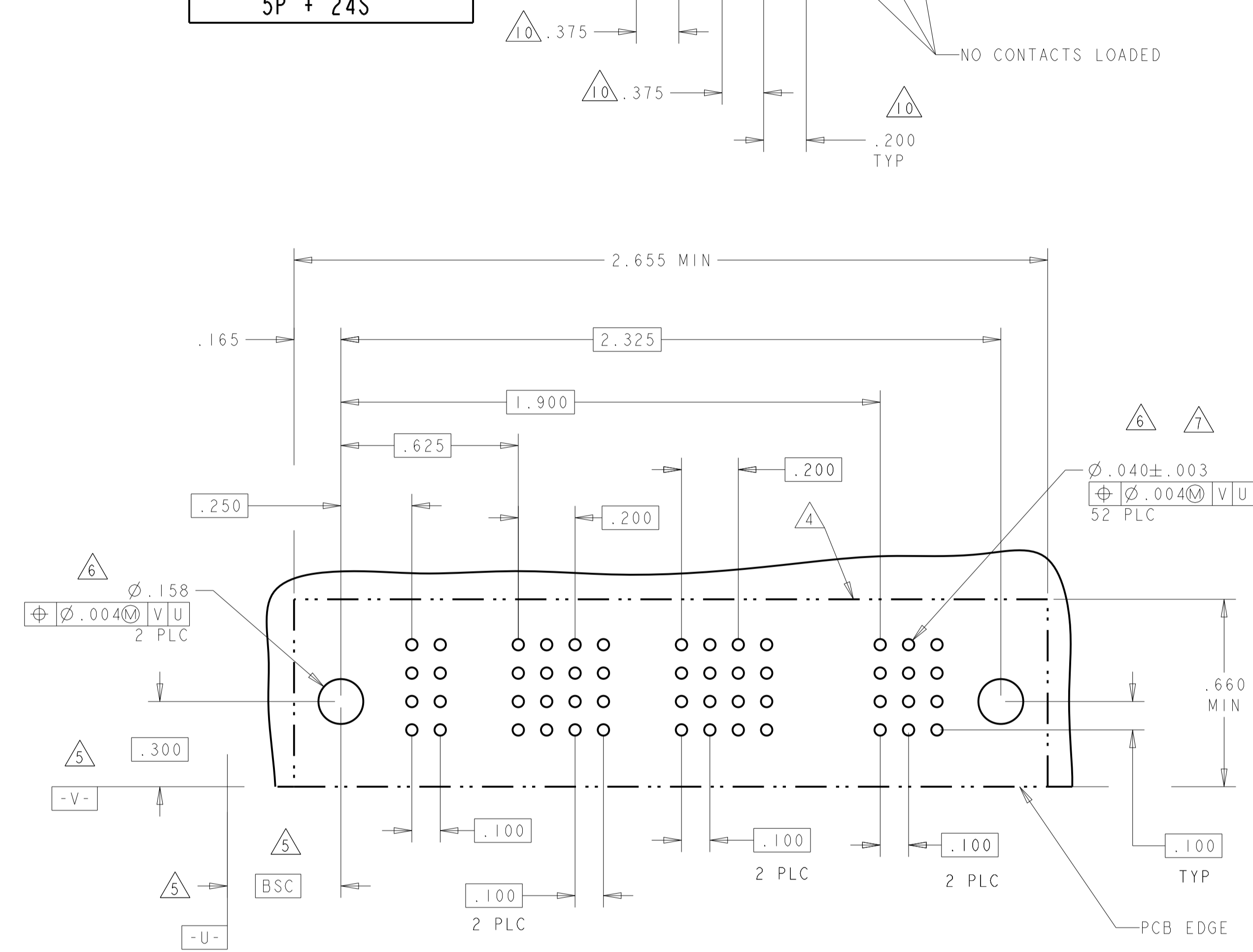
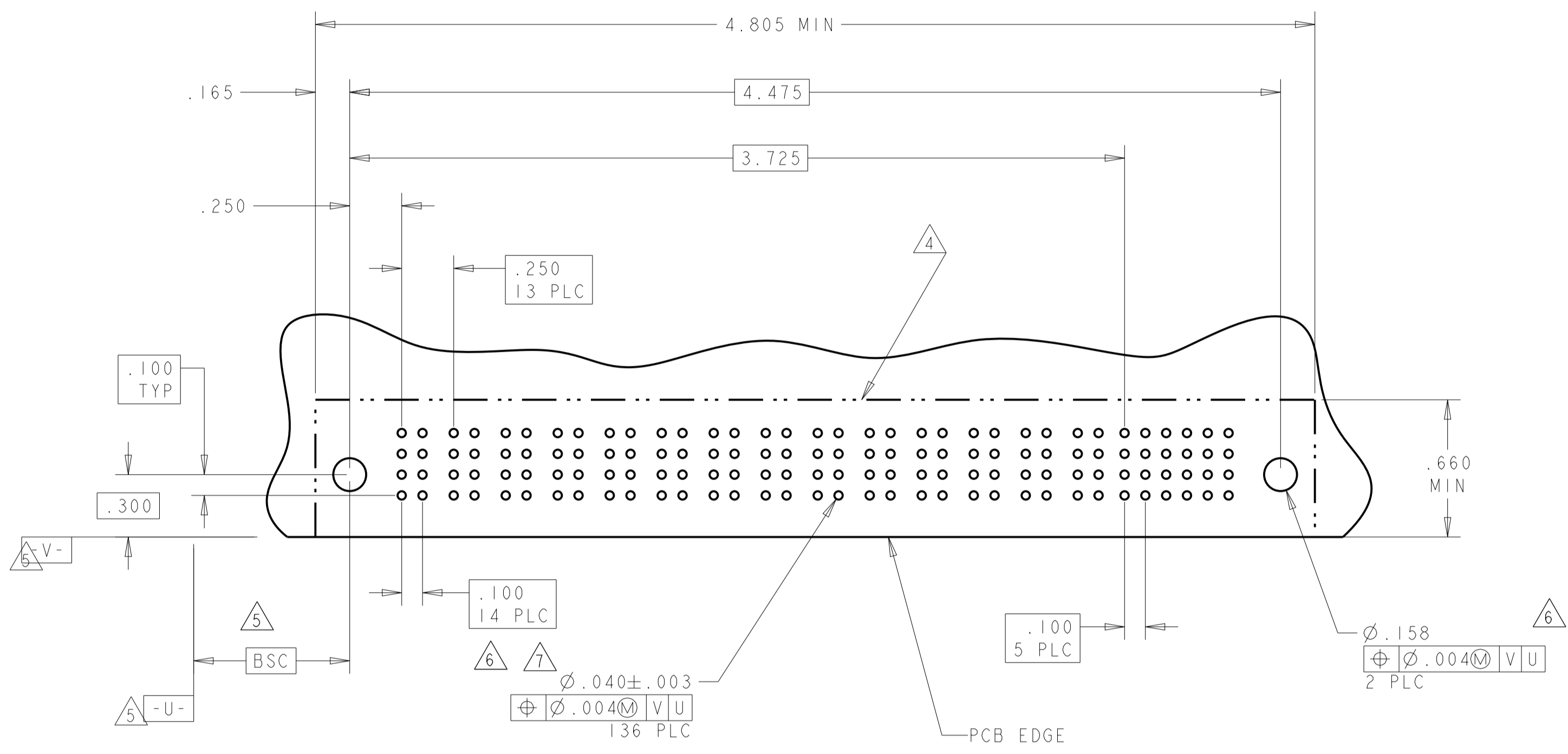

PART NUMBER	ROWS	POWER	SIGNAL					
		P1	1	2	3	4	5	6
6450332-6	D C B A	PM	E	E	E	E	E	J
		PM	F	F	F	F	F	F
		PM	G	G	G	G	G	G
		PM	H	H	H	H	H	H
1P + 24S								

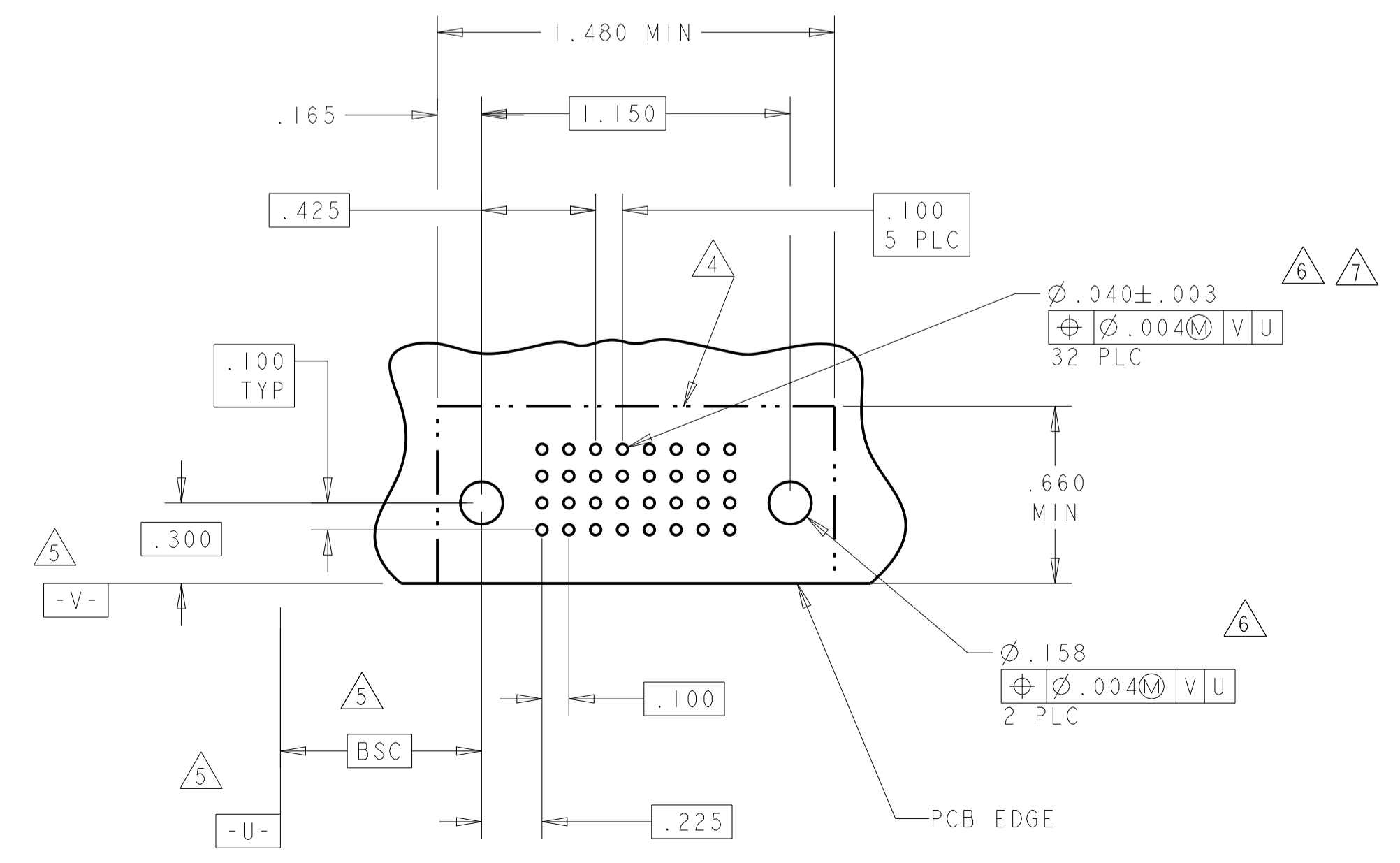

THIS DRAWING IS A CONTROLLED DOCUMENT.		OWN: R. GRZYBOWSKI 24JAN05	TE Connectivity	
DIMENSIONS: INCHES		CHK: M. PERCHERKE 24JAN05	NAME: RIGHT ANGLE SOLDER HEADER ASSEMBLY MULTI-BEAM XL	
TOLERANCES UNLESS OTHERWISE SPECIFIED:		APV: M. PERCHERKE	PRODUCT SPEC: 108-1973	
0 PLC ±.01		APV: M. PERCHERKE	APPLICATION SPEC: 114-13038	
1 PLC ±.01		APV: M. PERCHERKE	WEIGHT: -	
2 PLC ±.01		APV: M. PERCHERKE	SCALE: 4:1	
3 PLC ±.005		APV: M. PERCHERKE	SHEET 4 OF 13	
4 PLC ±.002		APV: M. PERCHERKE	REV: H6	
ANGLES ±.002		APV: M. PERCHERKE	CUSTOMER DRAWING	
FINISH: -		APV: M. PERCHERKE	SIZE: CAGE CODE DRAWING NO: A100779	
MATERIAL: -		APV: M. PERCHERKE	C=6450332	

LOC	DIST	REVISIONS			
P	LTH	DESCRIPTION	DATE	DMN	APVD
ES	00	SEE SHEET 1			

PART NUMBER	ROWS	POWER												SIGNAL			
		P1	P2	P3	P4	P5	P6	P7	P8	P9	P10	P11	P12	1	2	3	4
I-6450332-6	D C B A	PM	PM	PM	PM	PM	PM	PM	PM	PM	PM	PM	PM	J	J	J	J
		PM	PM	PM	PM	PM	PM	PM	PM	PM	PM	PM	PM	K	K	K	K
		PM	PM	PM	PM	PM	PM	PM	PM	PM	PM	PM	PM	N	N	N	N
		PM	PM	PM	PM	PM	PM	PM	PM	PM	PM	PM	PM	S	S	S	H

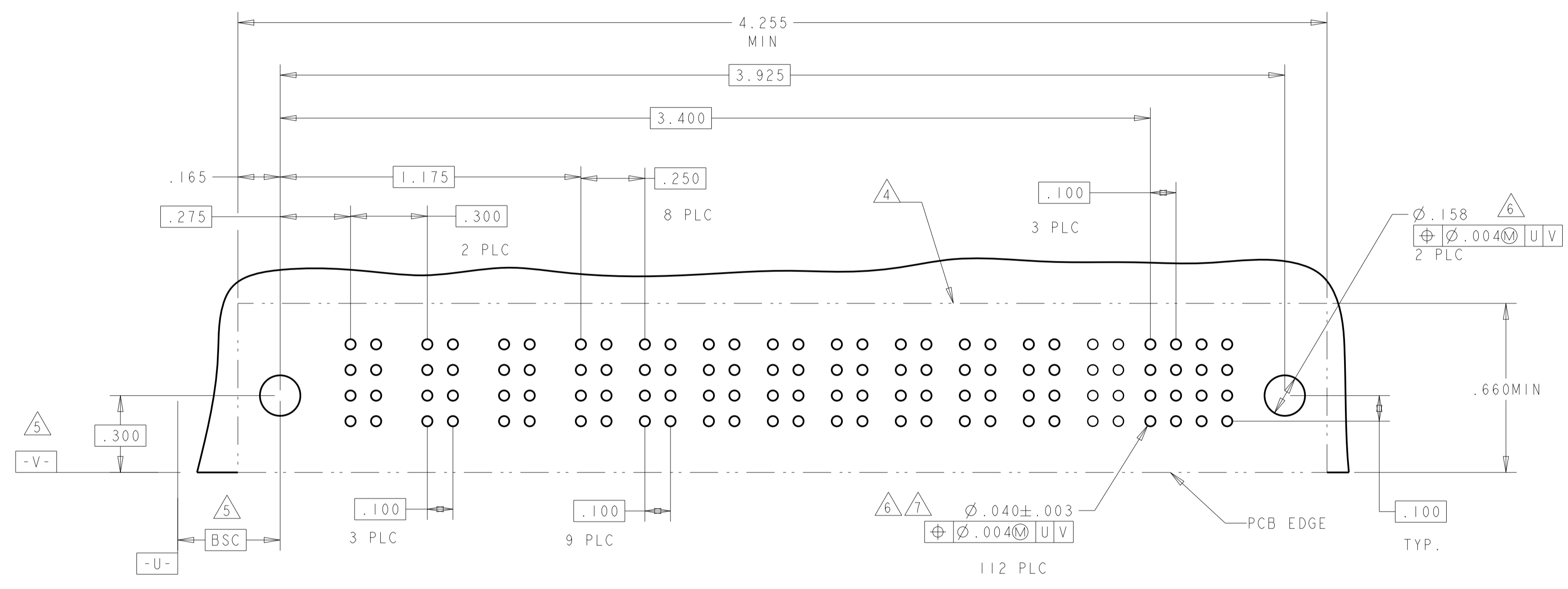

PART NUMBER	ROWS	POWER						SIGNAL				
		P1	P2	P3	P4	P5	P6	1	2	3	4	5
I-6450332-7	D C B A	PM	PM	PM	PM	PM	PM	J	J	J	J	J
		PM	PM	PM	PM	PM	PM	K	K	K	K	K
		PM	PM	PM	PM	PM	PM	N	N	N	N	N
		PM	PM	PM	PM	PM	PM	H	S	S	S	S

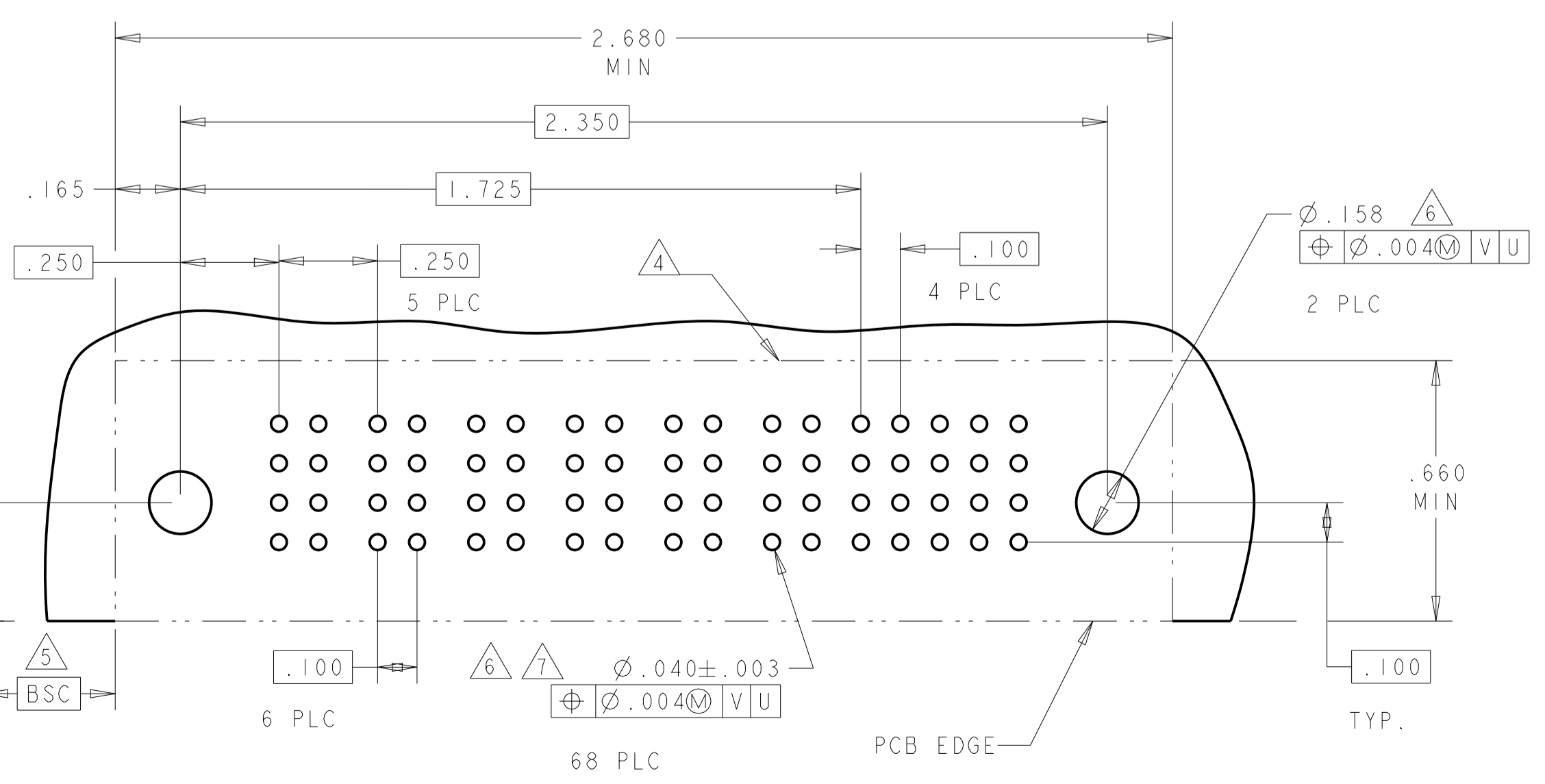

(B1) ADD SHEET 5 OF 6

THIS DRAWING IS A CONTROLLED DOCUMENT.		DMN: R. GRZYBOWSKI 24JAN05	TE Connectivity
DIMENSIONS: INCHES		CHK: M. PERCHERKE 24JAN05	
		APVD: M. PERCHERKE	NAME: RIGHT ANGLE SOLDER HEADER ASSEMBLY MULTI-BEAM XL
TOLERANCES UNLESS OTHERWISE SPECIFIED:		PRODUCT SPEC: 108-1973	SIZE: A100779
0 PLC ±.01		APPLICATION SPEC: 114-13038	CAGE CODE: 6450332
1 PLC ±.01		WEIGHT: -	RESTRICTED TO: -
2 PLC ±.01		CUSTOMER DRAWING	SCALE: 4:1 SHEET 6 OF 13 REV: H6
3 PLC ±.005			
4 PLC ±.002			
ANGLES ±.020			

LOC		DIST		REVISIONS				
ES	00	P	LTN	DESCRIPTION	DATE	DWN	APVD	
		-		SEE SHEET 1				

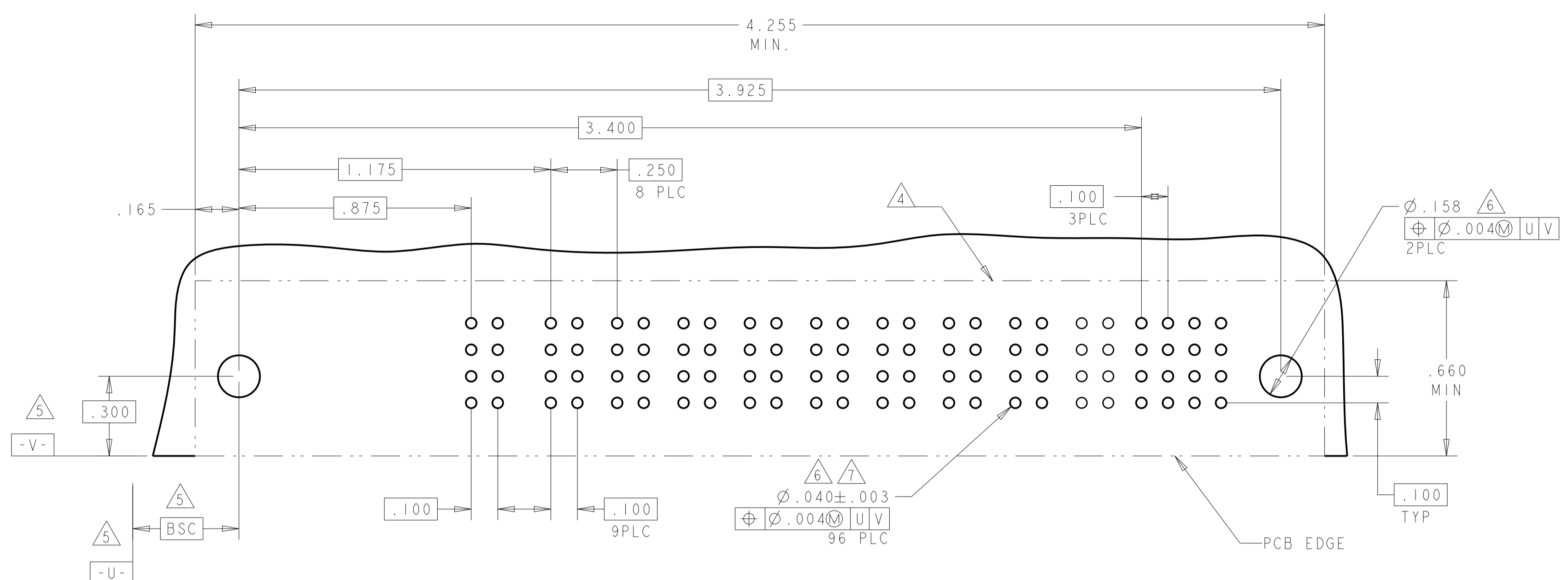

PART NUMBER	ROWS	POWER												SIGNAL			
		P1	P2	P3	P4	P5	P6	P7	P8	P9	P10	P11	P12	1	2	3	4
1-6450332-8	D C B A													J	J	J	J
				PM	PM	PM	PM	PM	PM	PM	PM	PM	PM	K	K	K	K
														S	S	S	H
IACP + 9P + 16S																	

PART NUMBER	ROWS	POWER									SIGNAL					
		P1	P2	P3	P4	P5	P6	P7	P8	P9	1	2	3	4	5	6
6450332-9	D C B A										J	E	J	J	J	E
				PM	PM	PM	PM	PM	PM	PM	K	K	K	K	F	F
											N	N	N	N	G	G
										S	S	S	S	H	S	
3ACP + 6P + 24S																

PART NUMBER	ROWS	POWER									SIGNAL					
		P1	P2	P3	P4	P5	P6	P7	P8	P9	1	2	3	4	5	6
2-6450332-3	D C B A										E	E	E	E	E	E
				PM	PM	PM	PM	PM	PM	PM	K	F	F	F	F	F
											N	G	G	G	G	G
										H	H	H	H	H	S	
3ACP + 6P + 24S																

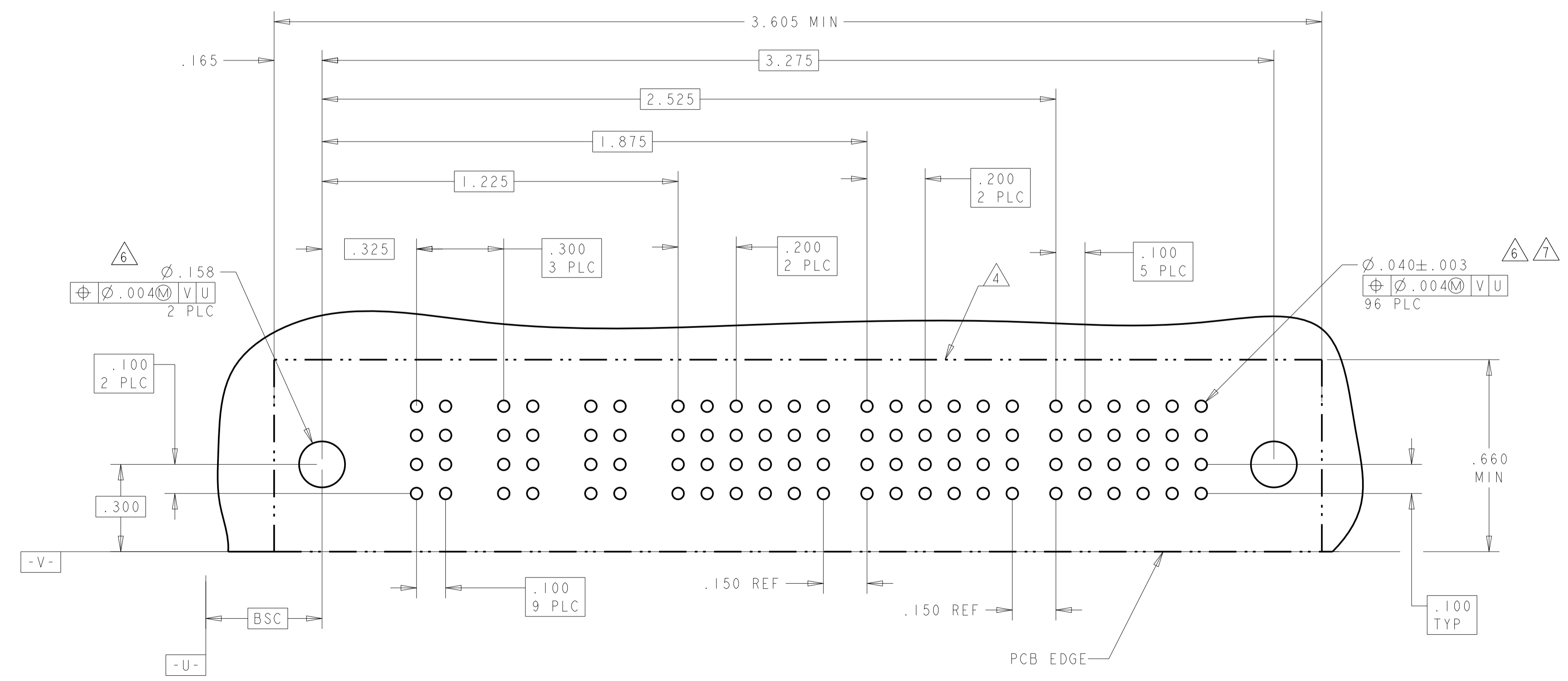
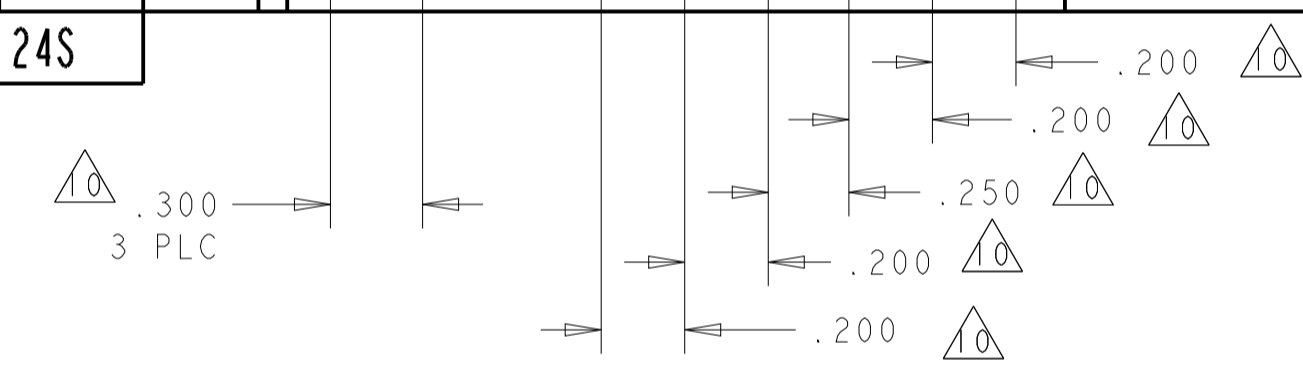

PART NUMBER 6450332-9 & 2-6450332-3 PCB LAYOUT

THIS DRAWING IS A CONTROLLED DOCUMENT. OWN: R. GRZYBOWSKI, 24JAN05
 CHK: M. PERCHERKE, 24JAN05
 APVD: M. PERCHERKE

STE TE Connectivity

NAME: RIGHT ANGLE SOLDER HEADER ASSEMBLY MULTI-BEAM XL

PRODUCT SPEC: 108-1973
 APPLICATION SPEC: 114-13038
 WEIGHT: -

SIZE: A1
 CAGE CODE: 6450332
 DRAWING NO: 6450332

CUSTOMER DRAWING SCALE: 4:1 SHEET 7 OF 13 REV: H6

LOC	DIST	REV	DATE	BY	APPV
ES	00				

PART NUMBER	ROWS	POWER								SIGNAL					
		P1	P2	P3	P4	P5	P6	P7	P8	1	2	3	4	5	6
2-6450332-4	D C B A	PM	PM	PM	PM	PM	PM	PM	PM	J	J	J	J	E	E
		PM	PM	PM	PM	PM	PM	PM	PM	K	K	K	K	F	F
		PM	PM	PM	PM	PM	PM	PM	PM	N	N	N	N	G	G
8P + 24S									S	S	S	S	H	H	

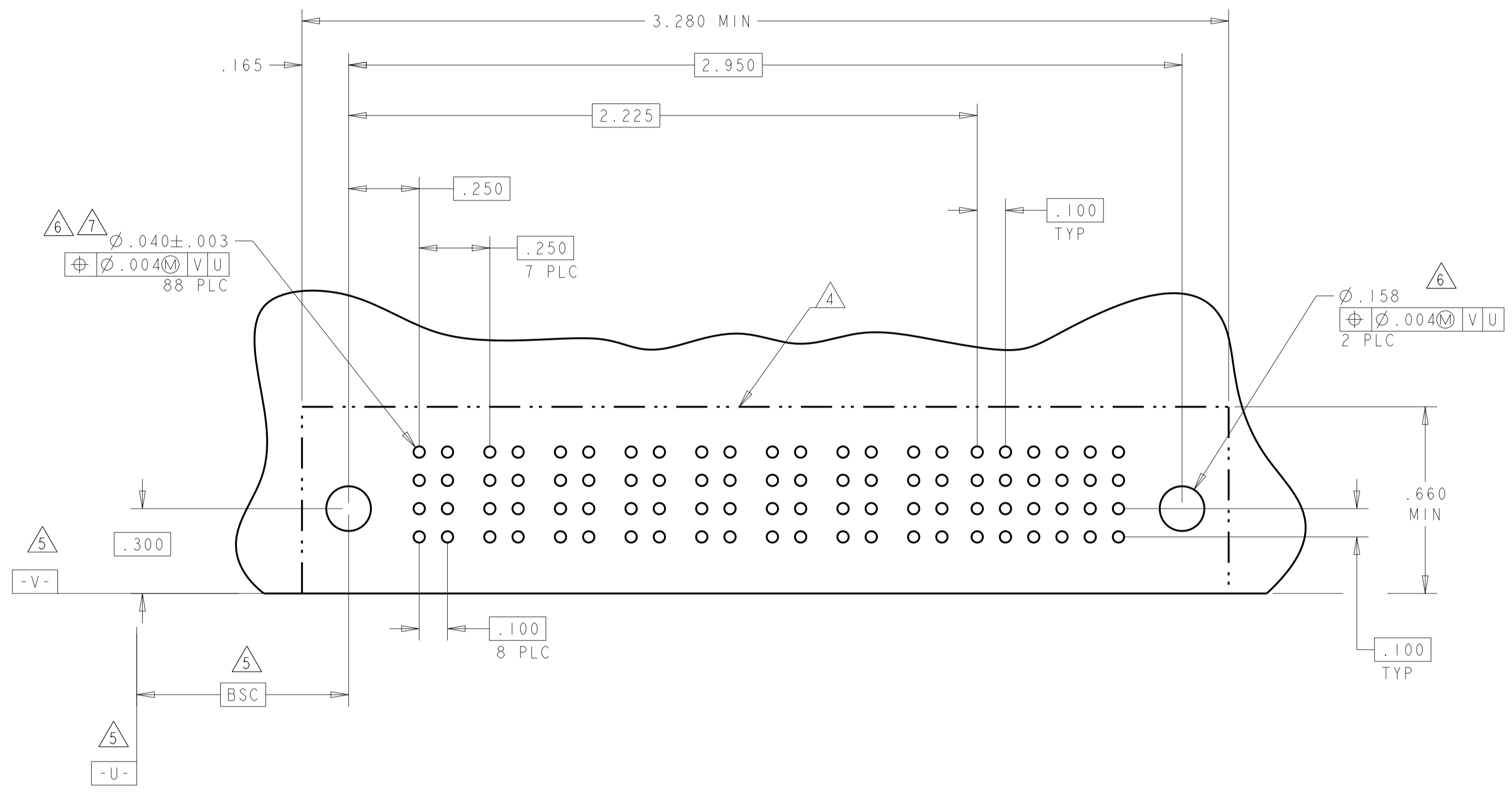

PART NUMBER	ROWS	POWER				SIGNAL					
		P1	P2	P3	P4	1	2	3	4	5	6
2-6450332-5	D C B A	PM	PM	PM	PM	E	E	E	E	E	E
		PM	PM	PM	PM	K	F	F	F	F	F
		PM	PM	PM	PM	N	G	G	G	G	G
4P + 24S						H	H	H	H	H	S

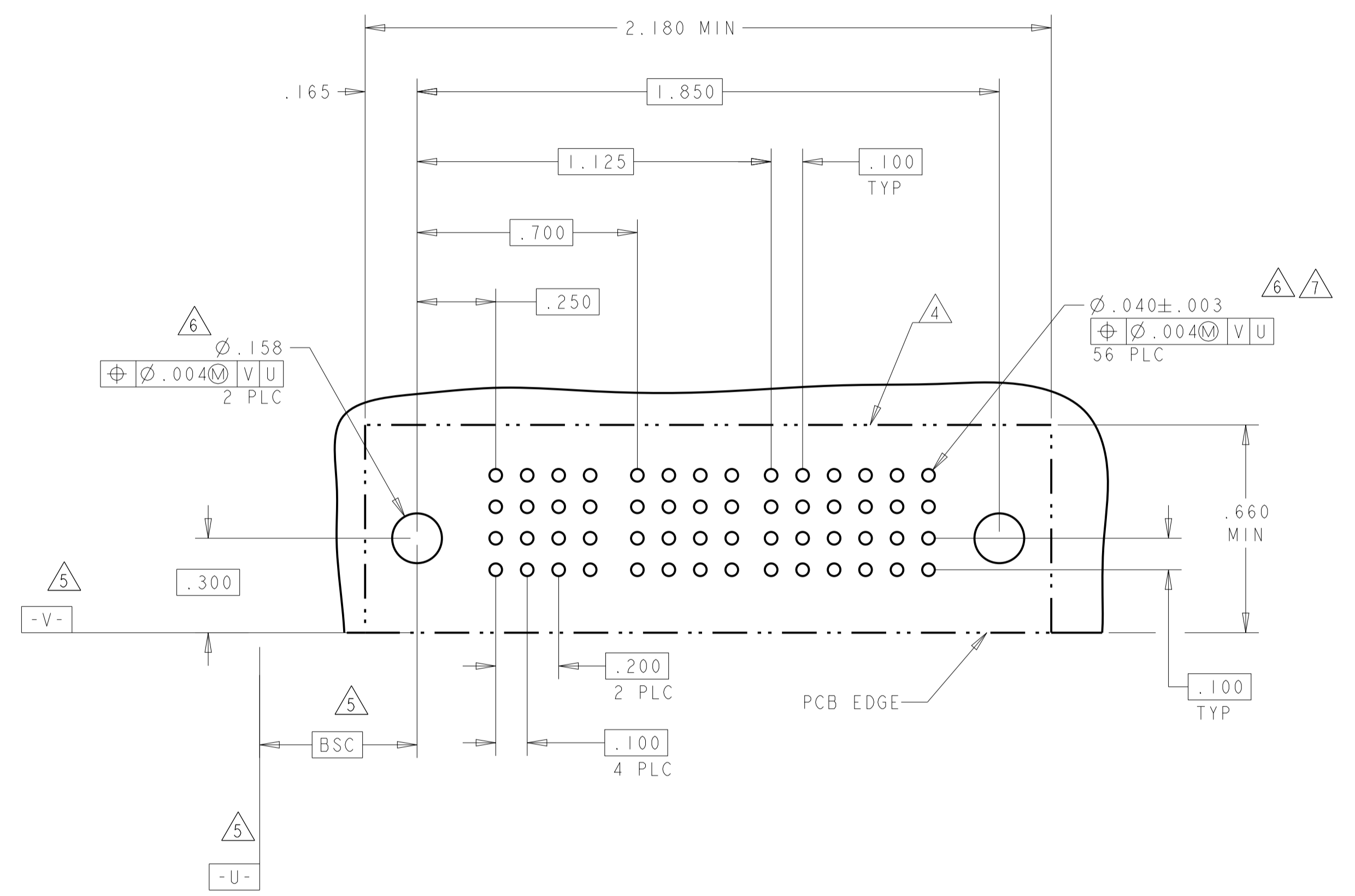

THIS DRAWING IS A CONTROLLED DOCUMENT.

DIMENSIONS: INCHES	TOLERANCES UNLESS OTHERWISE SPECIFIED: 0 PLC ±.01 2 PLC ±.01 3 PLC ±.01 4 PLC ±.005 5 PLC ±.005 ANGLES ±.020	FINISH	FINISH
-----------------------	--	--------	--------

OWN: R. GRZYBOWSKI	24JAN05	NAME: RIGHT ANGLE SOLDER HEADER ASSEMBLY MULTI-BEAM XL
CHK: M. PERCHERKE	24JAN05	PRODUCT SPEC: 108-1973
APVD: M. PERCHERKE		APPLICATION SPEC: 114-13038
		SIZE: A100779
		CAGE CODE: 6450332
		WEIGHT: -
		RESTRICTED TO: -
		CUSTOMER DRAWING

SCALE: 4:1 SHEET 9 OF 13 REV: H6

LOC	DIST	REVISIONS			
P	LTN	DESCRIPTION	DATE	DMN	APVD
ES	00	SEE SHEET 1			

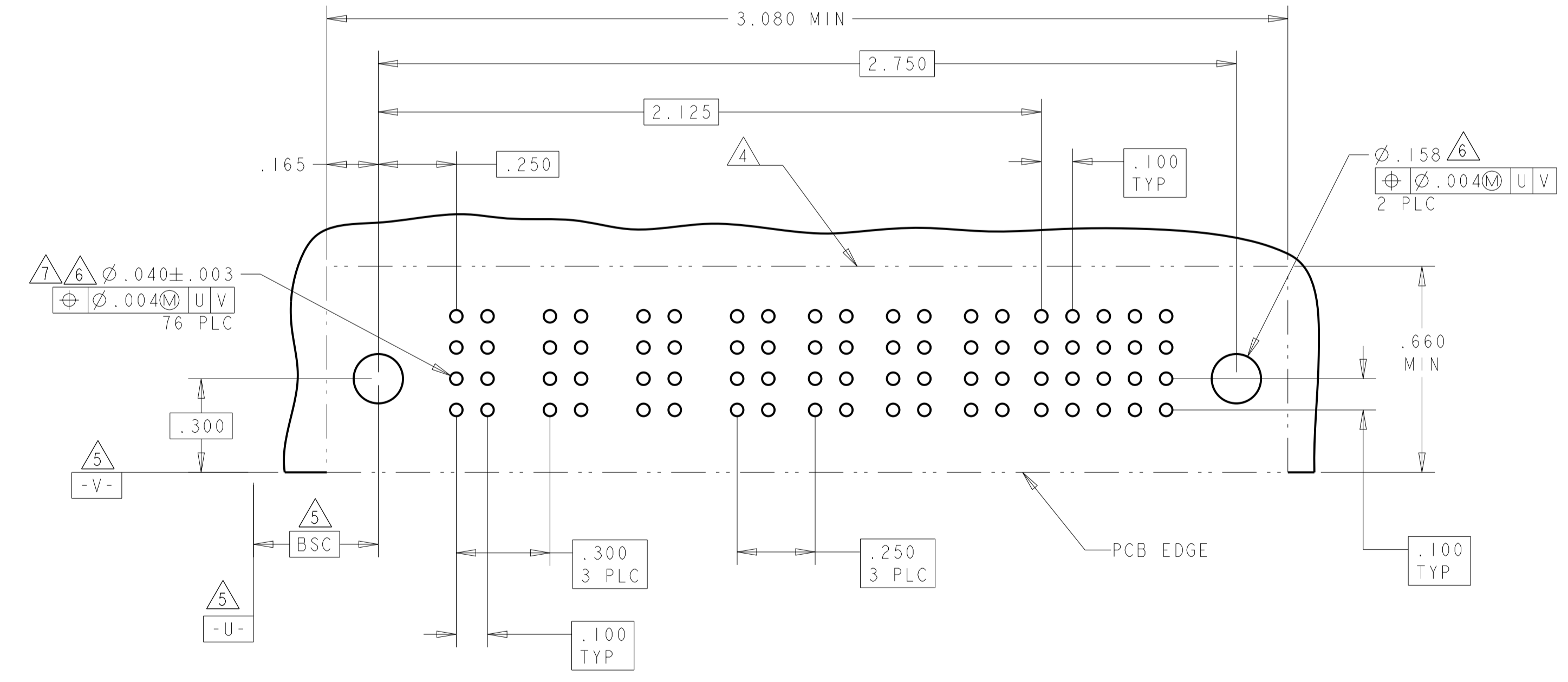
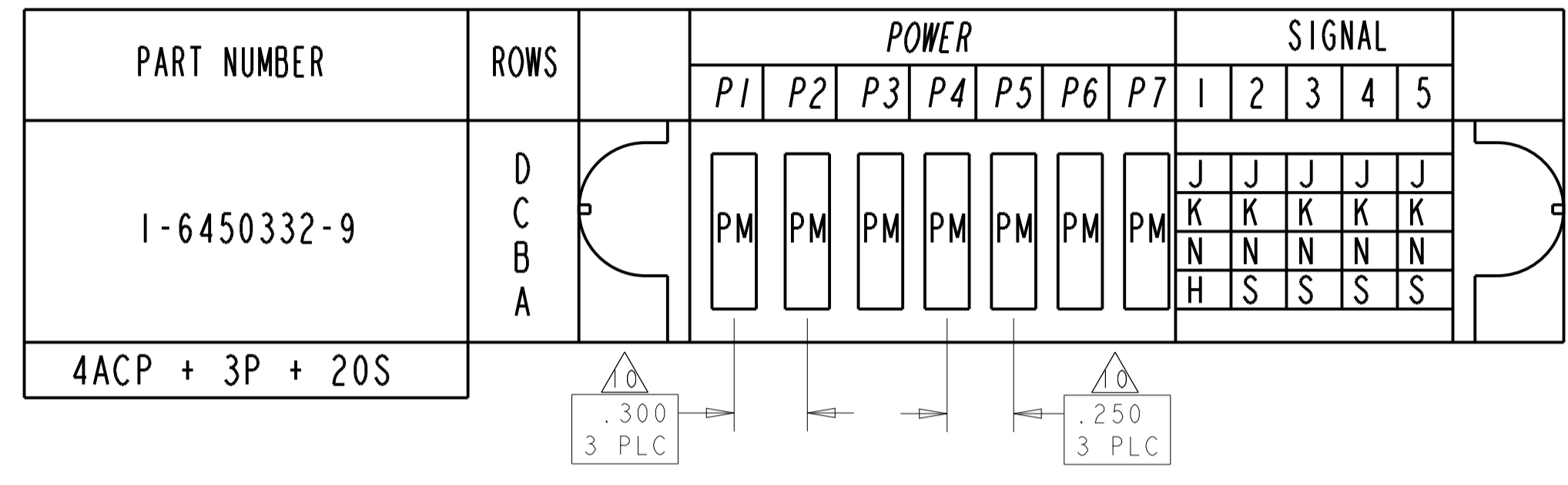

THIS DRAWING IS A CONTROLLED DOCUMENT.		DMN R. GRZYBOWSKI 24JAN05	NAME RIGHT ANGLE SOLDER HEADER ASSEMBLY MULTI-BEAM XL												
DIMENSIONS: INCHES		CHK M. PERCHERKE 24JAN05	RESTRICTED TO												
TOLERANCES UNLESS OTHERWISE SPECIFIED:		APVD M. PERCHERKE	SCALE 4:1 SHEET 11 OF 13 REV H6												
<table border="1"> <tr> <td>0 PLC</td> <td>±</td> </tr> <tr> <td>1 PLC</td> <td>±.01</td> </tr> <tr> <td>2 PLC</td> <td>±.01</td> </tr> <tr> <td>3 PLC</td> <td>±.01</td> </tr> <tr> <td>4 PLC</td> <td>±.005</td> </tr> <tr> <td>ANGLES</td> <td>±.0020</td> </tr> </table>		0 PLC	±	1 PLC	±.01	2 PLC	±.01	3 PLC	±.01	4 PLC	±.005	ANGLES	±.0020	PRODUCT SPEC 108-1973	SIZE A100779
0 PLC	±														
1 PLC	±.01														
2 PLC	±.01														
3 PLC	±.01														
4 PLC	±.005														
ANGLES	±.0020														
MATERIAL		APPLICATION SPEC 114-13038	CAGE CODE DRAWING NO C=6450332												
FINISH		WEIGHT	CUSTOMER DRAWING												

LOC		DIST		REVISIONS			
ES	00	P	LTM	DESCRIPTION	DATE	DMN	APVD
				SEE SHEET 1			

PART NUMBER	ROWS	POWER							SIGNAL						
		P1	P2	P3	P4	P5	P6	P7	P8	P9	1	2	3	4	5
3-6450332-0	D C B A	PM	PM	PM	PM	PM	PM	PM	PM	J	J	J	J	J	J
										K	K	K	K	K	K
										N	N	N	N	N	N
										S	S	S	S	S	S

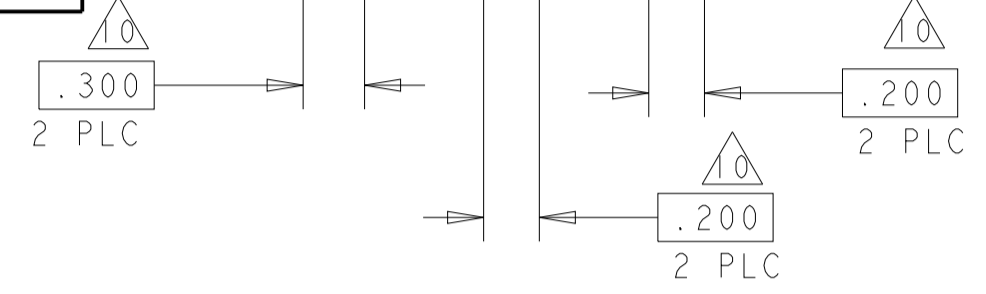

PART NUMBER	ROWS	POWER							SIGNAL					
		P1	P2	P3	P4	P5	P6	P7	1	2	3	4	5	6
3-6450332-1	D C B A	PM	PM	PM	PM	PM	PM	PM	J	J	J	J	J	J
									K	K	K	K	K	K
									N	N	N	N	N	N
									H	S	S	S	S	S

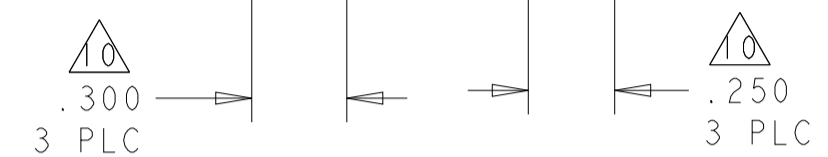

PART NUMBER	ROWS	POWER							SIGNAL					
		P1	P2	P3	P4	P5	P6	P7	1	2	3	4	5	6
3-6450332-3	D C B A	PM	PM	PM	PM	PM	PM	PM	E	E	J	J	J	E
									K	F	F	F	K	F
									N	G	G	G	N	G
									S	H	S	S	H	H

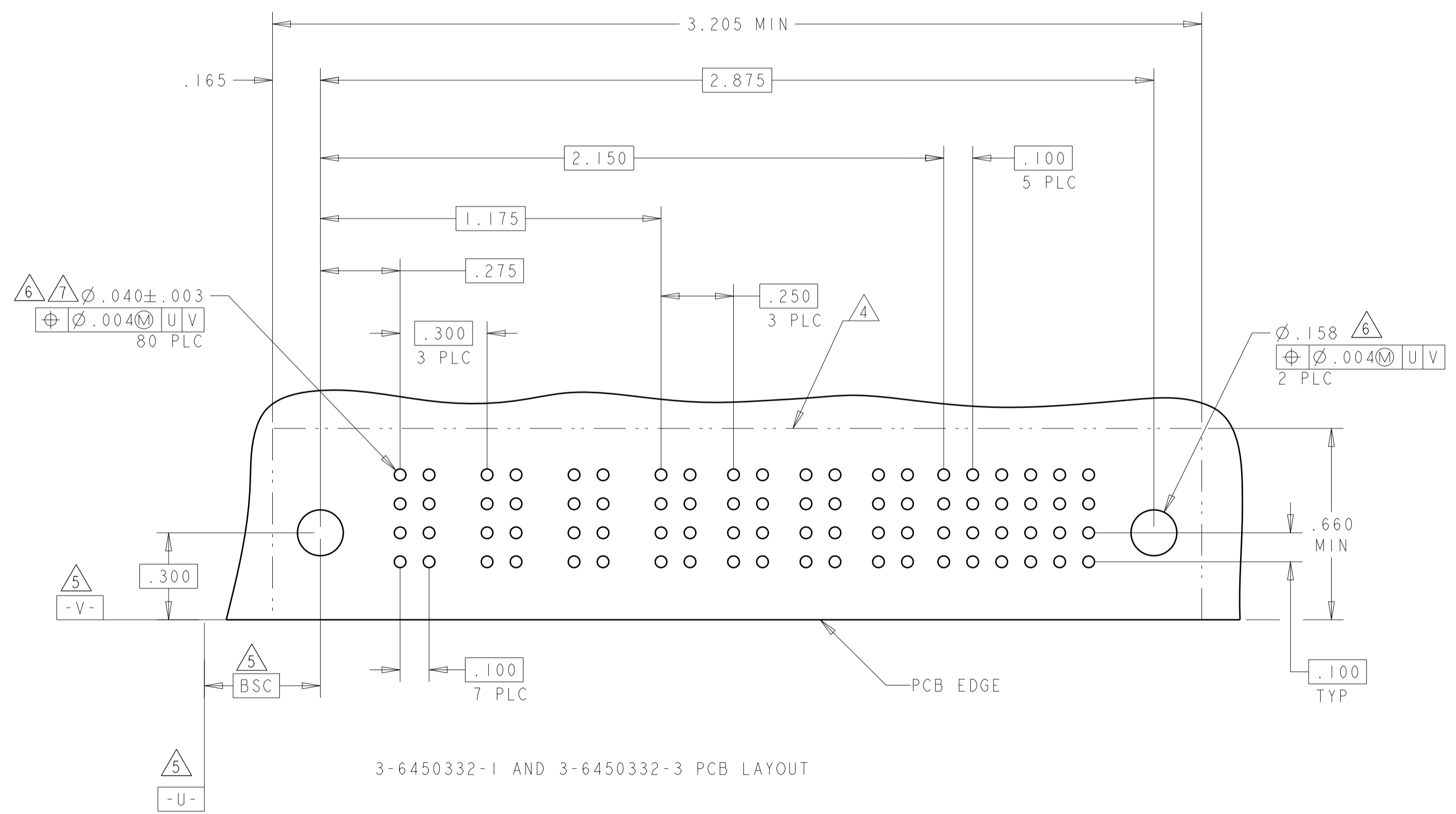
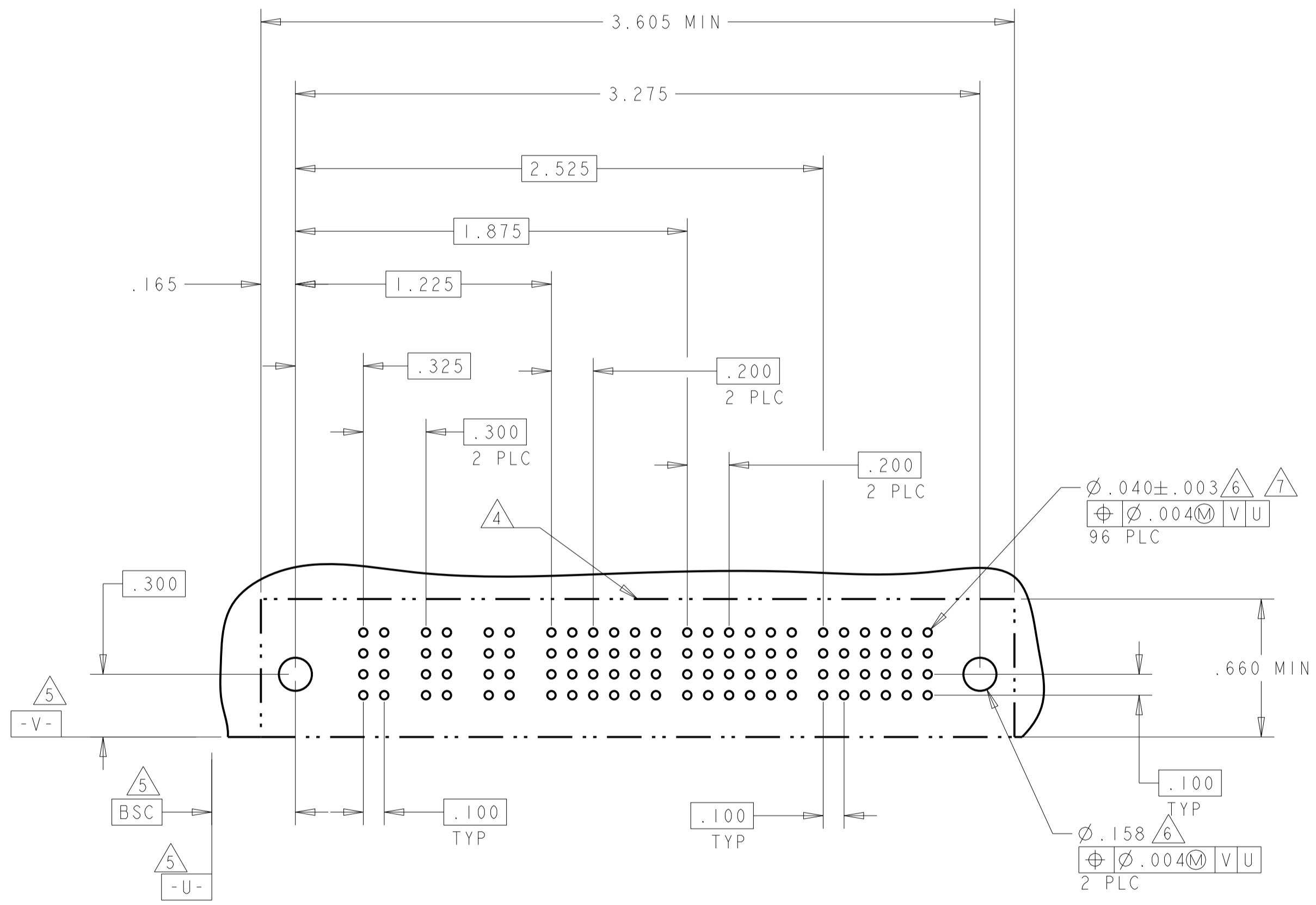
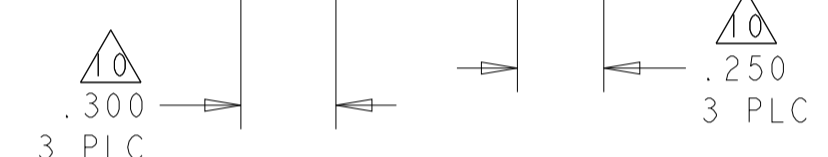

3-6450332-1 AND 3-6450332-3 PCB LAYOUT

THIS DRAWING IS A CONTROLLED DOCUMENT.

DIMENSIONS:	TOLERANCES UNLESS OTHERWISE SPECIFIED:	DMN: R. GRZYBOWSKI 24JAN05	CHK: M. PERCHERKE 24JAN05	APVD: M. PERCHERKE	NAME: RIGHT ANGLE SOLDER HEADER ASSEMBLY MULTI-BEAM XL
INCHES	0 PLC ±.01 2 PLC ±.01 3 PLC ±.01 4 PLC ±.005 ANGLES ±.0020	PRODUCT SPEC: 108-1973	APPLICATION SPEC: 114-13038	WEIGHT: -	SIZE: A100779
MATERIAL:	FINISH:	CUSTOMER DRAWING	SCALE: 4:1	SHEET: 12 OF 13	REV: H6

LOC		DIST		REVISIONS			
ES	00	P	LTN	DESCRIPTION	DATE	DWN	APVD
-	-	-	-	SEE SHEET 1	-	-	-

PART NUMBER	ROWS	POWER				SIGNAL		
		P1	P2	P3	P4	1	2	3
3-6450332-2	D C B A	PM	PM	PM	PM	J K N S	E F N S	J F N S
4P + 12S								

PART NUMBER	ROWS	POWER				SIGNAL					
		P1	P2	P3	P4	1	2	3	4	5	6
3-6450332-4	D C B A	PM	PM	PM	PM	E K N S	E F G H	J F G S	J F G S	J K N S	E F G H
4P + 24S											

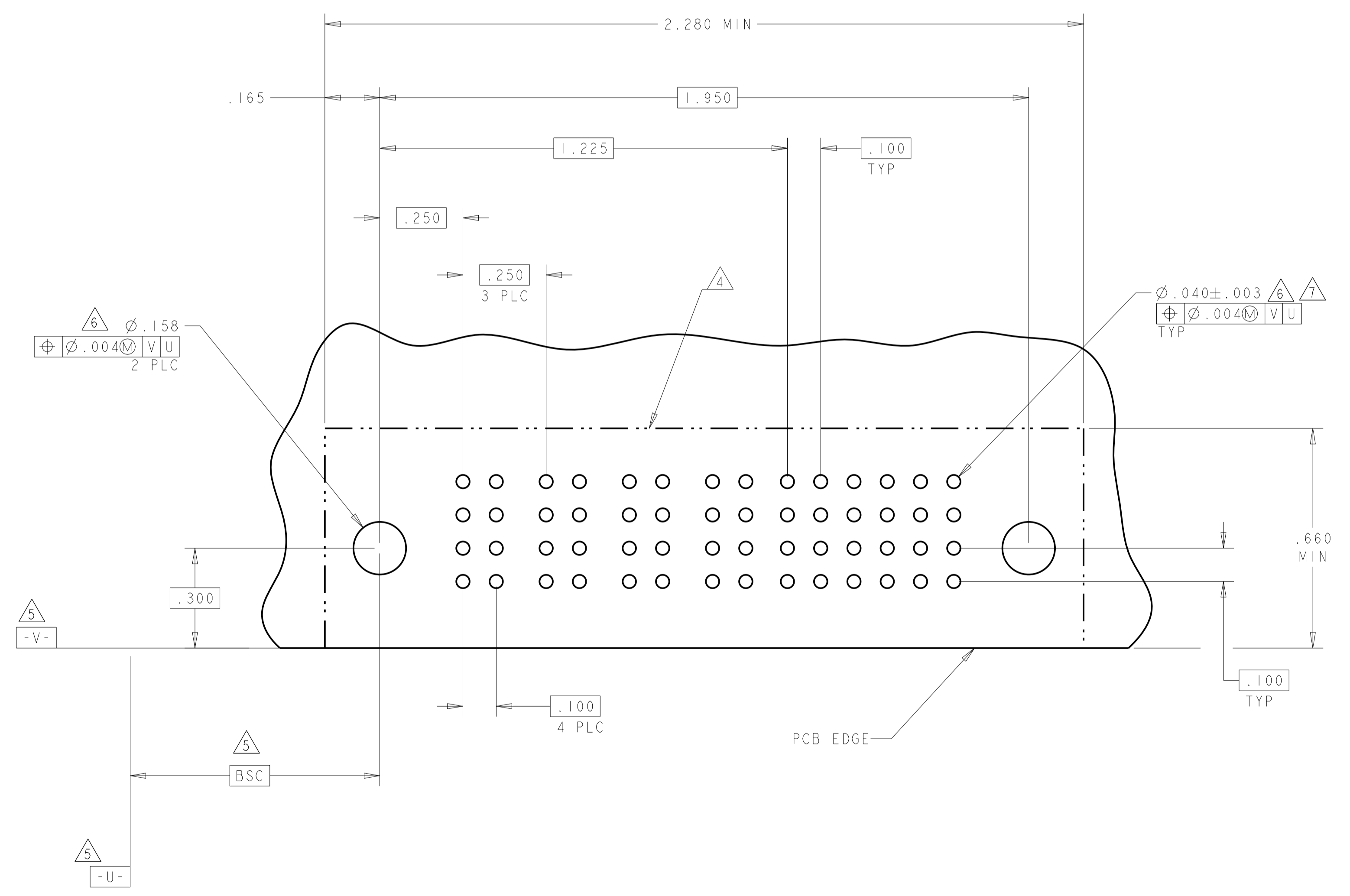
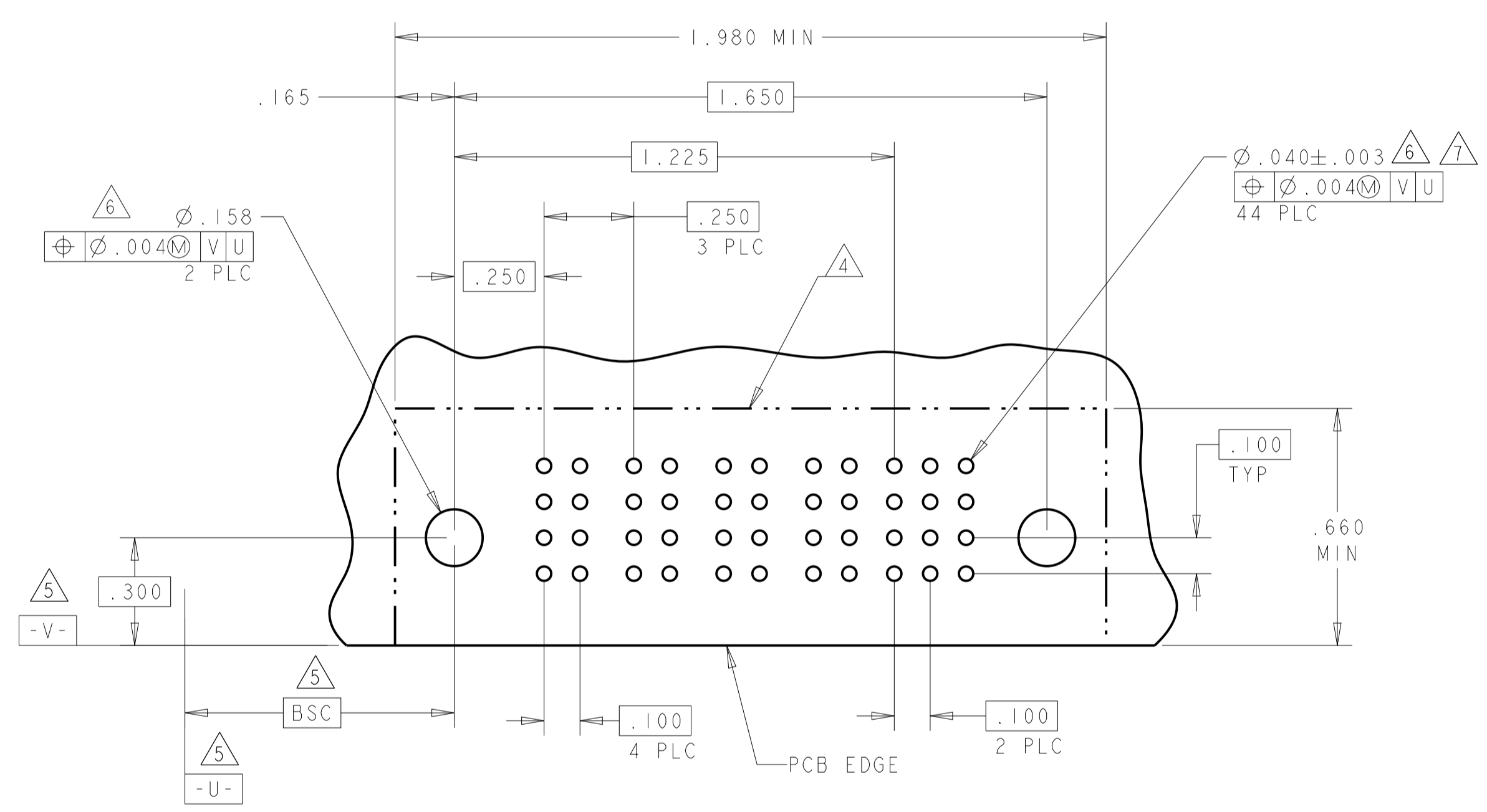

THIS DRAWING IS A CONTROLLED DOCUMENT. DWN: B. GRZYBOWSKI, 24JAN05
 CHK: M. PERCHERKE, 24JAN05

STE TE Connectivity

NAME: RIGHT ANGLE SOLDER HEADER ASSEMBLY MULTI-BEAM XL

PRODUCT SPEC: 108-1973
 APPLICATION SPEC: 114-13038

SIZE: A1
 CAGE CODE: 100779
 DRAWING NO: 6450332

RESTRICTED TO: -

CUSTOMER DRAWING SCALE: 4:1 SHEET: 13 OF 13 REV: H6

Компания «Life Electronics» занимается поставками электронных компонентов импортного и отечественного производства от производителей и со складов крупных дистрибьюторов Европы, Америки и Азии.

С конца 2013 года компания активно расширяет линейку поставок компонентов по направлению коаксиальный кабель, кварцевые генераторы и конденсаторы (керамические, пленочные, электролитические), за счёт заключения дистрибьюторских договоров

Мы предлагаем:

- Конкурентоспособные цены и скидки постоянным клиентам.
- Специальные условия для постоянных клиентов.
- Подбор аналогов.
- Поставку компонентов в любых объемах, удовлетворяющих вашим потребностям.
- Приемлемые сроки поставки, возможна ускоренная поставка.
- Доставку товара в любую точку России и стран СНГ.
- Комплексную поставку.
- Работу по проектам и поставку образцов.
- Формирование склада под заказчика.
- Сертификаты соответствия на поставляемую продукцию (по желанию клиента).
- Тестирование поставляемой продукции.
- Поставку компонентов, требующих военную и космическую приемку.
- Входной контроль качества.
- Наличие сертификата ISO.

В составе нашей компании организован Конструкторский отдел, призванный помогать разработчикам, и инженерам.

Конструкторский отдел помогает осуществить:

- Регистрацию проекта у производителя компонентов.
- Техническую поддержку проекта.
- Защиту от снятия компонента с производства.
- Оценку стоимости проекта по компонентам.
- Изготовление тестовой платы монтаж и пусконаладочные работы.



Тел: +7 (812) 336 43 04 (многоканальный)

Email: org@lifeelectronics.ru