

Interface Technology and Switching Devices

2013/2014

7





1 PCB connection technology and electronics housing

- PCB terminal blocks and plug-in connectors
- Electronics housing



2 Connection technology for field devices

- Plug-in connectors
- Cables and connectors



3 Modular terminal blocks

- Modular terminal blocks



4 Sensor/actuator cabling and industrial plug-in connectors

- Sensor/actuator cabling
- Cables and connectors
- Plug-in connectors



5 Marking systems, tools, and mounting material

- Marking and labeling
- Tools
- Installation and mounting material



6 Surge protection and power supply units

- Lightning monitoring system
- Surge protection and interference filters
- Power supply units and UPS
- Protective devices



7 Interface technology and switching devices



8 Control technology, I/O systems and automation infrastructure

- Ethernet networks • Functional safety • HMIs and industrial PCs • I/O systems
- Industrial lighting and signaling • Industrial communication technology
- Fieldbus components and systems • Wireless data communication
- Process infrastructure • Software • Controllers

Table of contents

Complete overview		2
Electronic switching devices and motor control		7
Measurement and control technology		53
Monitoring		193
Relay modules		265
System cabling for controllers		417
Technical information/index		566

Complete overview

Product range overview

Electronic switchgear and motor control



Motor management

Page 12



Hybrid motor starters

Page 18



Solid-state contactors

Page 38



IP67 motor starters

Page 48

Measurement and control technology



Digital displays

Page 150



Ex i isolating amplifiers with functional safety

Page 152



Multiplexers for HART signals

Page 186



Ex i 2-conductor field devices

Page 187

Monitoring



Compressed air meters

Page 208



Current transformers

Page 212



Test disconnect terminal blocks
See Catalog 3



Current transducers, current protectors

Page 229



Compact monitoring relays

Page 250



Multifunctional monitoring relays

Page 252



Ultra-narrow timer relays

Page 258



Multifunctional timer relays

Page 260

Measurement and control technology



Frequency inverters

Page 50



Highly compact isolating amplifiers

Page 64



Isolating amplifiers with functional safety

Page 100



Isolating amplifiers, special designs

Page 130



Shield fast connection and test plugs

Page 191



Controllers
See Catalog 8

Monitoring



Energy meters

Page 200



Complete packages for data logging

Page 206



Voltage transducers, AC and DC

Page 236



PV system monitoring

Page 134



Residual current monitoring

Page 244



Components for E-Mobility

Page 247



Special function modules

Page 262



Lightning current measuring system
See Catalog 6



HMIs
See Catalog 8



Signal towers
See Catalog 8

Complete overview

Product range overview

Relay modules



RIFLINE complete

Page 276



PLC series

Page 322



PR series

Page 372



DEK series

Page 397

System cabling for controllers



Front adapters

Page 424



Termination boards

Page 470



V8 adapters

Page 369



System cables

Page 500



Multi-channel relay modules

Page 550



Safety devices
See Catalog 8



Monitoring relays

Page 250



Timer relays

Page 258



Universal interface modules

Page 524



Potential distributors

Page 548



Electronic switchgear and motor control

Switching devices for starting, reversing, and protecting electric motors are some of the most frequently used components in automation technology. These are often designed redundantly for safety-sensitive applications. When it comes to reducing installation time and space requirements, CONTACTRON hybrid motor starters are the state-of-the-art alternative.

This is because CONTACTRON hybrid motor starters combine up to 4 functions in a single device. Integration in popular fieldbus systems is implemented using the SmartWire-DT™ wiring system.

For protection of the entire system, the product range now includes the electronic motor manager (EMM). In addition to typical measured values such as voltage and current, the behavior of the system is monitored and protected by means of real power measurement. The process data in all popular fieldbus systems can be supplied via gateways and evaluated by a controller.

Product range overview

Product overview	8
Electronic motor management	10
3-phase hybrid motor starters	16
Hybrid motor starters with short-circuit protection	29
Hybrid motor starters with SmartWire-DT™ support	31
3-phase solid-state reversing contactors	38
3-phase solid-state contactors	40
Solid-state reversing contactor for DC motors	44
Single-phase solid-state contactors	46
IP67 motor starters	48
IP20 frequency inverters	50

Product overview

Motor management



Electronic motor management
Page 12



Gateways
Page 14



Software
Page 15



Reversing load relays with soft starter
Page 42

Solid-state contactors



3-phase solid-state reversing contactors
Page 38



3-phase solid-state contactors
Page 40



Solid-state reversing contactor for
DC motors
Page 44



Single-phase solid-state contactors
Page 46

Frequency inverters



Inline frequency inverters for the
control cabinet
Page 50

Hybrid motor starters



3-phase hybrid motor starters Page 18



3-phase hybrid motor starters with short-circuit protection Page 29



Hybrid motor starters with SmartWire-DT™ support Page 31



Accessories Page 36

IP67 motor starters



PROFINET motor starters Page 48



Stainless steel base, IP67 protection Page 49

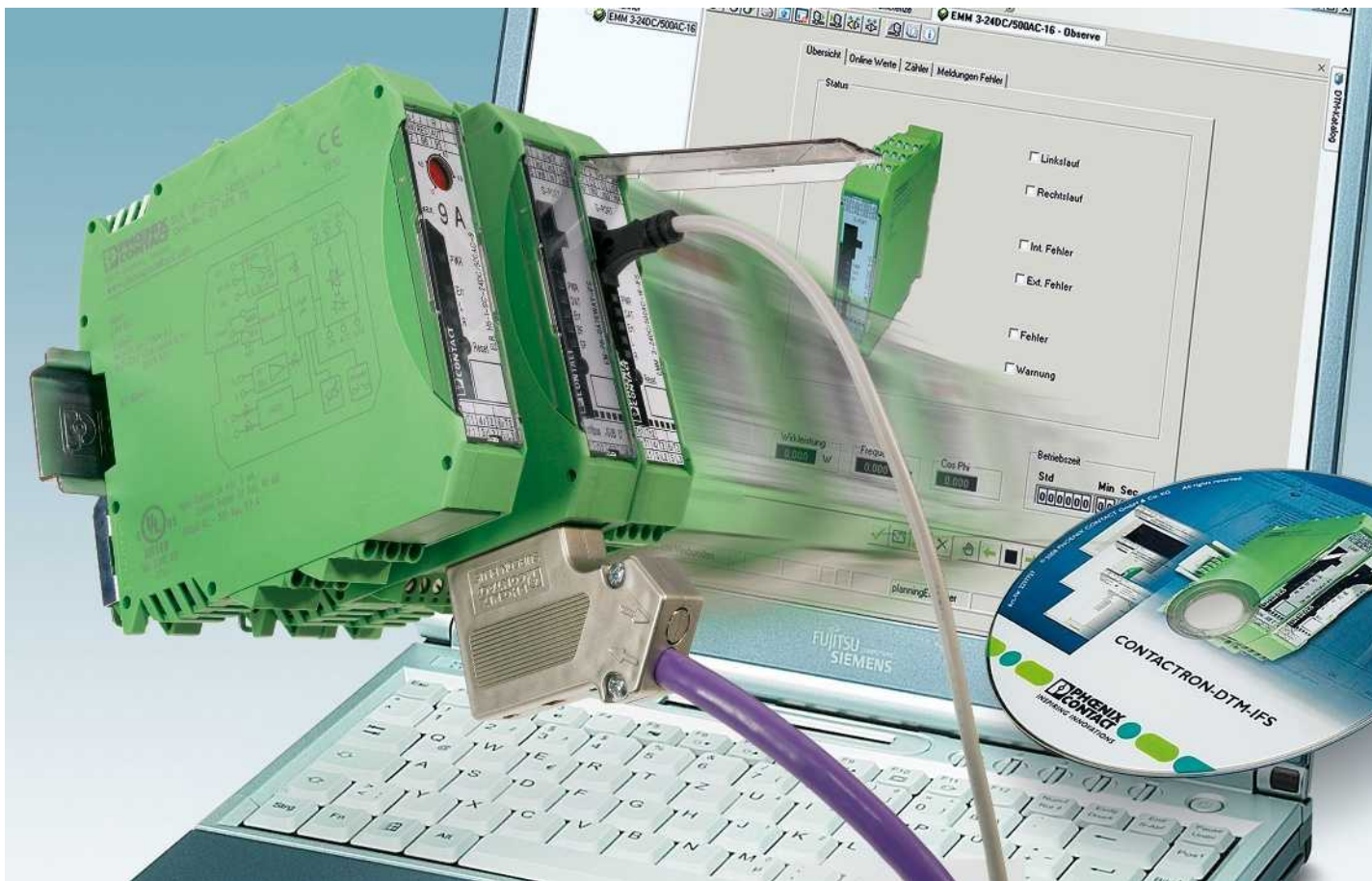

Electronic motor management (EMM)

The electronic motor management modules offer all the advantages of modern real power monitoring.

ELR-MM modules combine fast, wear-free electronic reversing load relays with modern measurement and evaluation electronics. EMM offers the same functionality for all performance classes, only without a power section.

Power within limits

Monitoring is based on freely parameterizable switching and signaling thresholds for overload and underload detection. Identical or separate settings can be made for the thresholds relating to the two directions of rotation. Parameterization relies on the real power consumed (calculated from three currents, voltages, and the phase angle), thereby offering a much more precise basis than if only the current is taken into consideration, as it is independent of voltage fluctuations and drive load. If a switching threshold is exceeded or not reached, the ELR-MM or EMM initiates an emergency shutdown of the motor immediately (or after an adjustable “delay time”). In addition, a message can be sent via an output.

This state can only be deactivated via a defined reset. If the effective power consumed is determined as being above or below the message thresholds, all that occurs is that a check-back is returned for the duration for which the module was addressed.

In addition, signals are generated by the module for the recognition of the direction of rotation. Asymmetry and phase failures are detected and signaled.

Permanent status monitoring with high scanning rates and the fast semiconductor switch enable complete system protection, including motor protection.

Without any extra wiring - and with just a single device - pumps, actuating drives, fans, and tools are monitored for proper functioning, contamination (filter or similar), and wear. The adjustable “inrush suppression” time can be used to mask out the switching operation from the monitoring process.



Protection against dry running, blocking, and cavitation, warning thresholds to indicate filter contamination.



Protection against blocking, warning thresholds for bearing wear and other cases that trigger overload.



Protection against blocking and broken tools, warning thresholds for tool and bearing wear.

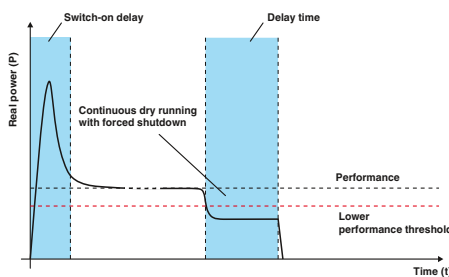

In the case of motor-driven pumps, the lower performance threshold provides reliable protection against hazardous dry running.



Forced shutdown of the drive can be delayed by the “delay time”. This prevents forced shutdown in the event of air bubbles.



Tooling machines are monitored and protected in a similar way when drilling, milling or grinding. If the feed value on a milling machine is set too high, a tool may break in the “worst-case” scenario. The power threshold - parameterized accordingly - can be used to resolve this issue.

Additionally, a message threshold signals tool wear in advance.

Motor management

Electronic motor management

The EMM motor management module (with/without current transformer) for all performance classes monitors and protects 3-phase loads, such as electrical drives.

- Freely parameterizable signaling or switching thresholds
- Digital outputs control external switching elements
- Optional connection to INTERFACE system and PROFIBUS-GATEWAY-IFS via TBUS



Allows the use of external current transformers



With integrated current transformers

Notes:
1) EMC: Class A product, see page 571

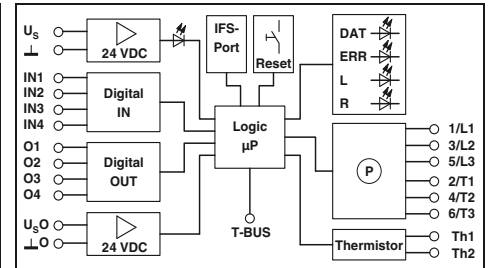
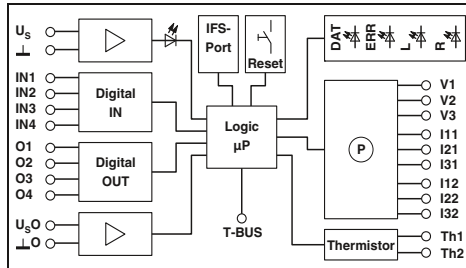

Technical data	
Input data	
Rated control supply voltage U_s	24 V DC 230 V AC
Rated control supply voltage range with reference to U_s	0.8 ... 1.25 0.4 ... 1.1
Rated control supply current I_s at U_s	25 mA 10 mA
Input data of digital inputs	EMM 3- 24DC/500AC-IFS ¹⁾ EMM 3-230AC/500AC-IFS ¹⁾
Number of inputs	4 (IN1 - IN4) 4 (IN1 - IN4)
Rated actuating voltage U_c	24 V DC 230 V AC
Rated actuating current I_c	3.3 mA 3.5 mA
Power measurement	
Voltage measuring input	42 V AC ... 575 V AC 42 V AC ... 575 V AC
Nominal current, voltage measuring input	< 0.5 mA < 0.5 mA
Current measuring input	5 A Secondary external converter 5 A Secondary external converter
Output power of the converter	> 1.25 VA > 1.25 VA
Internal resistance EMM	0.02 Ω 0.02 Ω
Output data for confirmation contacts	
O1 - O4 in the case of 1 signal	24 V DC (semiconductor output) / 500 mA 230 V AC (relay output/500 mA) / 500 mA
General data	
Rated insulation voltage	500 V
Rated surge voltage	6 kV/safe isolation 6 kV/safe isolation
Ambient temperature (operation)	-25°C ... 70°C
Standards/regulations	EN 60947 / EN 60947-4-2
EMC regulations	EN 61000-6-2 / EN 61000-6-3 / EN 61000-6-4
Degree of protection according to IEC 60529/ EN 60529	IP20
Mounting position	Vertical (horizontal DIN rail)
Screw connection solid / stranded / AWG	0.14 - 2.5 mm ² / 0.14 - 2.5 mm ² / 26 - 12
Dimensions	22.5 mm / 99 mm / 114.5 mm

Technical data	
Input data	
Rated control supply voltage U_s	24 V DC 230 V AC
Rated control supply voltage range with reference to U_s	0.8 ... 1.25 0.4 ... 1.1
Rated control supply current I_s at U_s	25 mA 10 mA
Input data of digital inputs	EMM 3- 24DC/500AC-IFS ¹⁾ EMM 3-230AC/500AC-IFS ¹⁾
Number of inputs	4 (IN1 - IN4) 4 (IN1 - IN4)
Rated actuating voltage U_c	24 V DC 230 V AC
Rated actuating current I_c	3.3 mA 3.5 mA
Power measurement	
Voltage measuring input	- -
Nominal current, voltage measuring input	- -
Current measuring input	max. 16 A max. 16 A
Output power of the converter	- -
Internal resistance EMM	- -
Output data for confirmation contacts	
O1 - O4 in the case of 1 signal	24 V DC (semiconductor output) / 500 mA 230 V AC (relay output/500 mA) / 500 mA
General data	
Rated insulation voltage	500 V
Rated surge voltage	6 kV/safe isolation 6 kV/safe isolation
Ambient temperature (operation)	-25°C ... 70°C
Standards/regulations	EN 60947 / EN 60947-4-2
EMC regulations	EN 61000-6-2 / EN 61000-6-3 / EN 61000-6-4
Degree of protection according to IEC 60529/ EN 60529	IP20
Mounting position	Vertical (horizontal DIN rail)
Screw connection solid / stranded / AWG	0.14 - 2.5 mm ² / 0.14 - 2.5 mm ² / 26 - 12
Dimensions	22.5 mm / 99 mm / 114.5 mm

Ordering data	
Description	
Electronic motor management	
EMM 3- 24DC/500AC-IFS ¹⁾	2297497 1
EMM 3-230AC/500AC-IFS ¹⁾	2297507 1

Ordering data	
Description	
Electronic motor management	
EMM 3- 24DC/500AC-16-IFS ¹⁾	2297523 1
EMM 3-230AC/500AC-16-IFS ¹⁾	2297536 1

Accessories	
Programming adapter for configuring modules with S-PORT interface	IFS-USB-PROG-ADAPTER ¹⁾ 2811271 1
DIN rail connector	ME 22,5 TBUS 1,5/ 5-ST-3,81 GN 2707437 50
Voltage transducer for 690 V, for EMM 3-.../500AC-IFS, comprising 3 modular terminal blocks and cover	UT 4-MTD-R/CVC 690/SET 2901667 1
Multi-functional memory block for the INTERFACE system	
- Flat design	IFS-CONFSTICK ¹⁾ 2986122 1
- Tall design	IFS-CONFSTICK-L 2901103 1
Mini COMBICON connectors	
- Socket contact	MC 1,5/ 5-ST-3,81 1803604 50
- Pin contact	IMC 1,5/ 5-ST-3,81 1857919 50

Accessories	
Programming adapter for configuring modules with S-PORT interface	IFS-USB-PROG-ADAPTER ¹⁾ 2811271 1
DIN rail connector	ME 22,5 TBUS 1,5/ 5-ST-3,81 GN 2707437 50
Voltage transducer for 690 V, for EMM 3-.../500AC-IFS, comprising 3 modular terminal blocks and cover	
Multi-functional memory block for the INTERFACE system	
- Flat design	IFS-CONFSTICK ¹⁾ 2986122 1
- Tall design	IFS-CONFSTICK-L 2901103 1
Mini COMBICON connectors	
- Socket contact	MC 1,5/ 5-ST-3,81 1803604 50
- Pin contact	IMC 1,5/ 5-ST-3,81 1857919 50

Electronic motor management



The electronic motor management modules offer all the advantages of modern effective power monitoring. Every 6.6 ms, the effective power of a drive system or of any other 3-phase consumer is calculated from three currents, voltages and the phase angle. Currents of up to 16 A can be directly acquired and currents >16 A are supplied via external converters. Digital outputs can be used to control separate mechanical or electronic switching elements that adopt the actual switching of the load. In this configuration, the EMM reliably protects connected loads – irrespective of their power consumption – against overload and underload, and provides permanent status monitoring.

Up to 8 freely parameterizable switching, message thresholds and up to four freely configurable inputs and outputs enable the protection of electrical drives and the system.

The EMM modules can record the following data:

- Apparent effective and reactive power
- Currents and voltages
- Phase angle
- Switching-cycle and operating-hours
- Power meter.

Additional Functions:

- Adjustable bimetal function class 5-30
- Thermistor monitor
- Recording measured values
- PROFIBUS connection via TBUS
- Pre-configured motor exits such as reversing starters, star delta starters, etc.

The EMM modules can be used to record complete "curves that can be used for system documentation.

The operating modes forward and reversing running, reverse and limit switch operation (with integrated restart inhibit) switch actuating and regulating drives, pumps etc. and also check for wear.

Current transformer

The external converters should be selected with a secondary nominal current of 5 A. The primary current is determined by the current consumption of the consumer (refer to connection diagram). For suitable current transformers, see catalog INTERFACE.

DIN rail connector TBUS

The **TBUS** (Order No. 2707437) can be used to supply several EMMs with 24 V DC or to couple up to 31 EMMs (for example) to the PROFIBUS-GATEWAY-IFS.

Switching element

Depending on the particular requirement of the application, either an electro-mechanical contactor or reversing contactor combination, or a semiconductor contactor or a solid-state reversing contactor is to be used for the actual task of switching the load. These switching elements are controlled via the digital outputs of the EMM modules.

Motor management

IFS gateways for electronic motor management modules

EM...GATEWAY-IFS for connecting EMM...IFS modules to popular bus systems: PROFIBUS DP, Modbus, Modbus TCP, DeviceNet™, and CANopen®.

- Communication via T-BUS with up to 31 EMM...IFS modules
- Equipped with freely parameterizable digital inputs and outputs
- Digital switching outputs for direct control of EMM...IFS (forward/reverse running)

Notes:

1) EMC: Class A product, see page 571



Technical data

Input data	
Operating voltage U_B	24 V DC -20 % ... +25 %
Nominal input current at U_{IN}	85 mA
Input circuit	Polarity protection, surge protection
Digital inputs	
Input voltage	24 V DC $\pm 20\%$
Nominal input current at U_{IN}	3 mA
Input circuit	Polarity protection, surge protection
Digital outputs	
Maximum switching voltage	23 V DC ($U_B - U_{resid.}$ of the output)
Max. switching current	500 mA
Residual voltage	1 V
Output protection	Parallel protection against polarity reversal, pay attention to the fuse
IFS interface	
Connection method	TBUS
General data	
Test voltage data interface/power supply	1.5 kV
Ambient temperature (operation)	-35°C ... 50°C
Nominal operating mode	100% operating factor
Standards/regulations	EN 50178
Degree of protection	IP20
Mounting position/mounting	Any / -
Connection data solid / stranded / AWG	0.2 ... 2.5 mm ² / 0.2 ... 2.5 mm ² / 24 - 12
Dimensions	22.5 mm / 99 mm / 114.5 mm

Ordering data

Description	Type	Order No.	Pcs. / Pkt.
IFS gateways for electronic motor management modules			
PROFIBUS DP	EM-PB-GATEWAY-IFS ¹⁾	2297620	1
RS-232	EM-RS232-GATEWAY-IFS	2901526	1
RS-485	EM-RS485-GATEWAY-IFS	2901527	1
Modbus TCP	EM-MODBUS-GATEWAY-IFS	2901528	1
DeviceNet™	EM-DNET-GATEWAY-IFS	2901529	1
CANopen®	EM-CAN-GATEWAY-IFS	2901504	1

Accessories

Programming adapter for configuring modules with S-PORT interface	IFS-USB-PROG-ADAPTER ¹⁾	2811271	1
DIN rail connector	ME 22,5 TBUS 1,5/ 5-ST-3,81 GN	2707437	50
Mini COMBICON connectors			
- Socket contact	MC 1,5/ 5-ST-3,81	1803604	50
- Pin contact	IMC 1,5/ 5-ST-3,81	1857919	50

Device Type Manager (DTM) for motor management modules

EMM...IFS

- CONTACTRON-DTM-IFS, programming adapter, and user manual on CD available as configuration package
- Also available as USB programming adapter even individually
- CONTACTRON-DTM-IFS also available free of charge as a separate download from www.phoenixcontact.com



Notes:

1) EMC: Class A product, see page 571

Ordering data		
Type	Order No.	Pcs. / Pkt.
Configuration package for the EMM...IFS, comprising CONTACTRON-DTM-IFS, USB programming adapter, and user manual on CD		
MM-CONF-SET	2297992	1
Accessories		
Programming adapter for configuring modules with S-PORT interface		
IFS-USB-PROG-ADAPTER ¹⁾	2811271	1



Hybrid motor starters for controlling 3-phase asynchronous motors combine up to four functions in one device as required. These include forward running, reverse running with optional reversing function including load wiring. The locking circuit for the reversing function is also integrated and certified as a single electronic reversing starter according to UL 508a and the new UL 60947-1. Furthermore, the devices protect the motor by means of an integrated motor protection relay with automatic and remote reset function. The implemented safety function according to Performance Level e (PL e) of EN ISO 13849-1 provides the emergency stop requirement. A PDT confirmation contact provides information regarding the availability of the device, and the motor state. This means that in the event of motor control without an error message the integrated current measurement and symmetry scanning ensures that the motor is turning. Even with these numerous functions, the hybrid motor starter is just 22.5 mm wide.

Short-circuit-proof hybrid motor starters with integrated protective devices, for mounting on 35 mm DIN rails and 60 mm busbar systems and connection to popular bus systems via SmartWire-DT™ complete the product portfolio.



Hybrid motor starters with up to four functions in one device: forward running, reverse running, motor protection, and emergency stop.



Short-circuit-proof hybrid motor starters with integrated fuses for mounting on 35 mm DIN rails and 60 mm busbar systems.



Connection of hybrid motor starters in a bus system via SmartWire-DT™. Gateways are provided for the main bus systems: PROFIBUS, Modbus TCB, EtherNet/IP™, and CANopen®.



The uniform design of the control side enables the combination of short-circuit-proof hybrid motor starters with SmartWire-DT™ adapters for integration in a bus system.

Hybrid motor starters

"4 in 1" hybrid motor starter with reversing function, motor protection, and emergency stop

These 3-phase "4 in 1" hybrid motor starters combine four functions in one device: right contactor, left contactor, motor protection relay, and emergency stop up to category 3.

Offer the following advantages:

- 22.5 mm wide
- They save wiring
- Bi-metal function can be set up to 9 A
- Long service life
- Space-saving
- 3-phase loop bridging

Safety level according to:

- IEC 61508-1: SIL3
- ISO 13849: PL e



For reversing 3~ AC motors up to 550 V AC/3 x 0.6 A



For reversing 3~ AC motors up to 550 V AC/3 x 2 A



Notes:
Type of housing: Polyamide PA non-reinforced, color: green.
Marking systems and mounting material See Catalog 5

Technical data

Input data		
Rated control supply voltage U_s	24 V DC	230 V AC (50/60 Hz)
Rated control supply voltage range with reference to U_s	0.8 ... 1.25	0.4 ... 1.1
Rated control supply current I_s at U_s	40 mA	4 mA
Rated actuating voltage U_c R/L	24 V DC	230 V AC
Rated actuating voltage range with reference to U_c	0.8 ... 1.25	0.4 ... 1.1
Rated actuating current I_c at U_c	5 mA	7 mA
Input circuit	Protection against polarity reversal, Surge protection	Surge protection
Operating voltage / status / error indicator	Green LED / Yellow LED / Red LED	
Output data load side		
Output voltage range	42 V AC ... 550 V AC	42 V AC ... 550 V AC
Load current	max. 600 mA (see derating curve)	max. 600 mA (see derating curve)
Surge current	100 A (t = 10 ms)	100 A (t = 10 ms)
Min. load current	75 mA	75 mA
Residual voltage	< 0.2 V	< 0.2 V
Output protection	Surge protection	
General data		
Rated insulation voltage	500 V	
Rated surge voltage	6 kV/safe isolation	6 kV/safe isolation
Ambient temperature (operation)	-25°C ... 70°C	
Electrical service life	3 x 10 ⁷ cycles	
Standards/regulations	DIN EN 50178 / EN 60947	
Mounting position	Vertical (horizontal DIN rail)	
Mounting	Can be aligned with spacing = 20 mm	
Connection data solid / stranded / AWG	0.14 - 2.5 mm ² / 0.14 - 2.5 mm ² / 26 - 14	
Dimensions	22.5 mm / 99 mm / 114.5 mm	W / H / D
Safety data		
EC-type examination certificate according to ATEX	Ex II (2) G, Ex II (2) D PTB 07 ATEX 3145	Ex II (2) G, Ex II (2) D PTB 07 ATEX 3145

Technical data		
Rated control supply voltage U_s	24 V DC	230 V AC (50/60 Hz)
Rated control supply voltage range with reference to U_s	0.8 ... 1.25	0.4 ... 1.1
Rated control supply current I_s at U_s	40 mA	4 mA
Rated actuating voltage U_c R/L	24 V DC	230 V AC
Rated actuating voltage range with reference to U_c	0.8 ... 1.25	0.4 ... 1.1
Rated actuating current I_c at U_c	5 mA	7 mA
Input circuit	Protection against polarity reversal, Surge protection	Surge protection
Operating voltage / status / error indicator	Green LED / Yellow LED / Red LED	
Output data load side		
Output voltage range	42 V AC ... 550 V AC	42 V AC ... 550 V AC
Load current	max. 2.4 A (see derating curve)	max. 2.4 A (see derating curve)
Surge current	100 A (t = 10 ms)	100 A (t = 10 ms)
Min. load current	180 mA	180 mA
Residual voltage	< 0.3 V	< 0.3 V
Output protection	Surge protection	
General data		
Rated insulation voltage	500 V	
Rated surge voltage	6 kV/safe isolation	6 kV/safe isolation
Ambient temperature (operation)	-25°C ... 70°C	
Electrical service life	3 x 10 ⁷ cycles	
Standards/regulations	DIN EN 50178 / EN 60947	
Mounting position	Vertical (horizontal DIN rail)	
Mounting	Can be aligned with spacing = 20 mm	
Connection data solid / stranded / AWG	0.14 - 2.5 mm ² / 0.14 - 2.5 mm ² / 26 - 14	
Dimensions	22.5 mm / 99 mm / 114.5 mm	
Safety data		
EC-type examination certificate according to ATEX	Ex II (2) G, Ex II (2) D PTB 07 ATEX 3145	Ex II (2) G, Ex II (2) D PTB 07 ATEX 3145

Technical data

Input data		
Rated control supply voltage U_s	24 V DC	230 V AC (50/60 Hz)
Rated control supply voltage range with reference to U_s	0.8 ... 1.25	0.4 ... 1.1
Rated control supply current I_s at U_s	40 mA	4 mA
Rated actuating voltage U_c R/L	24 V DC	230 V AC
Rated actuating voltage range with reference to U_c	0.8 ... 1.25	0.4 ... 1.1
Rated actuating current I_c at U_c	5 mA	7 mA
Input circuit	Protection against polarity reversal, Surge protection	Surge protection
Operating voltage / status / error indicator	Green LED / Yellow LED / Red LED	
Output data load side		
Output voltage range	42 V AC ... 550 V AC	42 V AC ... 550 V AC
Load current	max. 2.4 A (see derating curve)	max. 2.4 A (see derating curve)
Surge current	100 A (t = 10 ms)	100 A (t = 10 ms)
Min. load current	180 mA	180 mA
Residual voltage	< 0.3 V	< 0.3 V
Output protection	Surge protection	
General data		
Rated insulation voltage	500 V	
Rated surge voltage	6 kV/safe isolation	6 kV/safe isolation
Ambient temperature (operation)	-25°C ... 70°C	
Electrical service life	3 x 10 ⁷ cycles	
Standards/regulations	DIN EN 50178 / EN 60947	
Mounting position	Vertical (horizontal DIN rail)	
Mounting	Can be aligned with spacing = 20 mm	
Connection data solid / stranded / AWG	0.14 - 2.5 mm ² / 0.14 - 2.5 mm ² / 26 - 14	
Dimensions	22.5 mm / 99 mm / 114.5 mm	
Safety data		
EC-type examination certificate according to ATEX	Ex II (2) G, Ex II (2) D PTB 07 ATEX 3145	Ex II (2) G, Ex II (2) D PTB 07 ATEX 3145

Ordering data

Description		
"4 in 1" hybrid motor starter, incl. right contactor, left contactor, motor protection relay, and emergency stop		
Screw connection	ELR H5-IES-SC- 24DC/500AC-0,6	2900582
Push-in connection	ELR H5-IES-PT-24DC/500AC-0,6	2903902
Screw connection	ELR H5-IES-SC-230AC/500AC-0,6	2900692
"4 in 1" hybrid motor starter, incl. right contactor, left contactor, motor protection relay, and emergency stop, terminals L1, L2, L3 and T1, T2, T3 rotated		

Type	Order No.	Pcs. / Pkt.

Ordering data

Description		
"4 in 1" hybrid motor starter, incl. right contactor, left contactor, motor protection relay, and emergency stop		
Screw connection	ELR H5-IES-SC- 24DC/500AC-2	2900414
Push-in connection	ELR H5-IES-PT-24DC/500AC-2	2903904
Screw connection	ELR H5-IES-SC-230AC/500AC-2	2900420
"4 in 1" hybrid motor starter, incl. right contactor, left contactor, motor protection relay, and emergency stop, terminals L1, L2, L3 and T1, T2, T3 rotated		



For reversing 3~ AC motors
up to 550 V AC/3 x 9 A

CB
Ex: Ex

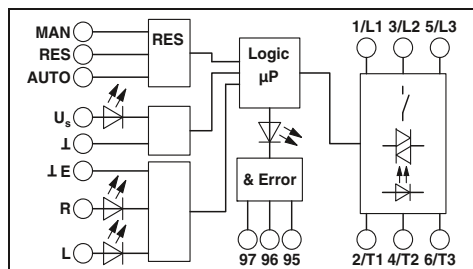

Technical data

24 V DC 230 V AC (50/60 Hz)
0.8 ... 1.25 0.4 ... 1.1

40 mA 4 mA
24 V DC 230 V AC
0.8 ... 1.25 0.4 ... 1.1

5 mA 7 mA
Protection against polarity reversal, Surge protection
Surge protection

Green LED / Yellow LED / Red LED

42 V AC ... 550 V AC 42 V AC ... 550 V AC
max. 9 A max. 9 A
(see derating curve) (see derating curve)

100 A (t = 10 ms) 100 A (t = 10 ms)
1.5 A 1.5 A
< 0.5 V < 0.5 V
Surge protection

500 V 6 kV/safe isolation 6 kV/safe isolation
-25°C ... 70°C
3 x 10⁷ cycles
DIN EN 50178 / EN 60947
Vertical (horizontal DIN rail)
Can be aligned with spacing = 20 mm
0.14 - 2.5 mm² / 0.14 - 2.5 mm² / 26 - 14
22.5 mm / 99 mm / 114.5 mm

Ex II (2) G, Ex II (2) D Ex II (2) G, Ex II (2) D
PTB 07 ATEX 3145 PTB 07 ATEX 3145

Ordering data

Type	Order No.	Pcs. / Pkt.
ELR H5-IES-SC- 24DC/500AC-9	2900421	1
ELR H5-IES-PT-24DC/500AC-9	2903906	1
ELR H5-IES-SC-230AC/500AC-9	2900422	1
ELR W3- 24DC/500AC- 9I	2297057	1
ELR W3-230AC/500AC- 9I	2297060	1

Conventional structure

Main current path reversing contactor according to category 3

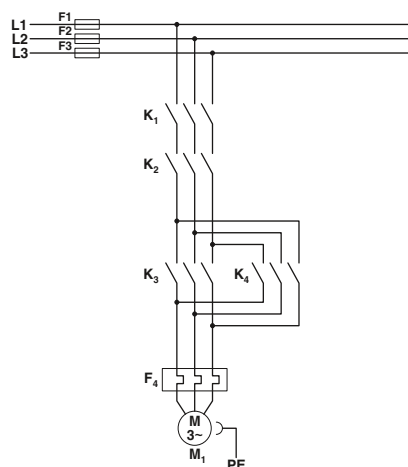

K1 + K2 = Emergency stop contactor
K3 = Left contactor
K4 = Right contactor
F4 = Motor protection relay

Structure with CONTACTRON

Main and control current path for "4 in 1" hybrid motor starter with reversing function according to category 3

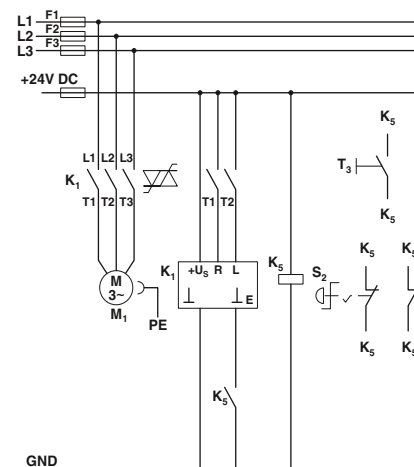

K1 = "4 in 1" hybrid motor starter with reversing function
K5 = PSR SCP-24DC.../Safety relay
T1 = Left, T2 = Right, T3 = Reset
S2 = Emergency stop

Conventional structure

Control current path reversing contactor according to category 3



K1 + K2 = Emergency stop contactor
K3 = Left contactor
K4 = Right contactor
K5 = PSR SCP-24DC.../Safety relay
T1 = Left, T2 = Right, T3 = Reset
S2 = Emergency stop
F4 = Motor protection relay



Derating curve ELR H5-IES-SC-230AC/500AC-0,6
100% operating time



Derating curve ELR H5-IES-SC-24DC/500AC-2 and
ELR H5-IES-SC-24DC/500AC-9
100% operating time

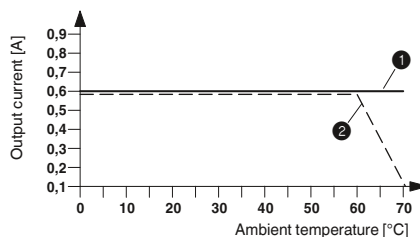

Derating curve ELR H5-IES-SC-24DC/500AC-0,6
100% operating time

1 Aligned with > 20 mm spacing
2 Aligned without spacing



Derating curve ELR H5-IES-SC-230AC/500AC-2 and
ELR H5-IES-SC-230AC/500AC-9
100% operating time

Hybrid motor starters

"3 in 1" hybrid motor starter with motor protection and emergency stop

These 3-phase "3 in 1" hybrid motor starters combine three functions in one device: right contactor, motor protection relay, and emergency stop up to category 3.

Offer the following advantages:

- 22.5 mm wide
- They save wiring
- Bi-metal function can be set up to 9 A
- Long service life
- Space-saving
- 3-phase loop bridging
- Safety level according to:
 - IEC 61508-1: SIL3
 - ISO 13849: PL e



For starting 3~ AC motors up to 550 V AC/3 x 0.6 A



For starting 3~ AC motors up to 550 V AC/3 x 2 A



Notes:	
Type of housing:	Polyamide PA non-reinforced, color: green.
Marking systems and mounting material	See Catalog 5

Technical data	
Rated control supply voltage U_s	24 V DC 0.8 ... 1.25
Rated control supply voltage range with reference to U_s	230 V AC (50/60 Hz) 0.4 ... 1.1
Rated control supply current I_s at U_s	40 mA
Rated actuation voltage U_c ON	4 mA
Rated actuating voltage range with reference to U_c	24 V DC 0.8 ... 1.25
Rated actuating current I_c at U_c	230 V AC 0.4 ... 1.1
Rated actuating current I_c at U_c	5 mA
Input circuit	7 mA
Protection against polarity reversal, Surge protection	Surge protection
Operating voltage / status / error indicator	Green LED / Yellow LED / Red LED
Output data load side	
Output voltage range	42 V AC ... 550 V AC
Load current	max. 600 mA (see derating curve)
Surge current	100 A (t = 10 ms)
Min. load current	75 mA
Residual voltage	< 0.2 V
Output protection	Surge protection
General data	
Rated insulation voltage	500 V
Rated surge voltage	6 kV/safe isolation
Ambient temperature (operation)	6 kV/safe isolation
Electrical service life	-25°C ... 70°C
Standards/regulations	3 x 10 ⁷ cycles
Mounting position	DIN EN 50178 / EN 60947
Mounting	Vertical (horizontal DIN rail)
Connection data solid / stranded / AWG	Can be aligned with spacing = 20 mm
Dimensions	0.14 - 2.5 mm ² / 0.14 - 2.5 mm ² / 26 - 14
Safety data	22.5 mm / 99 mm / 114.5 mm
EC-type examination certificate according to ATEX	Ex II (2) G, Ex II (2) D PTB 07 ATEX 3145

Technical data	
Rated control supply voltage U_s	24 V DC 0.8 ... 1.25
Rated control supply voltage range with reference to U_s	230 V AC (50/60 Hz) 0.4 ... 1.1
Rated control supply current I_s at U_s	40 mA
Rated actuation voltage U_c ON	4 mA
Rated actuating voltage range with reference to U_c	24 V DC 0.8 ... 1.25
Rated actuating current I_c at U_c	230 V AC 0.4 ... 1.1
Rated actuating current I_c at U_c	5 mA
Input circuit	7 mA
Protection against polarity reversal, Surge protection	Surge protection
Operating voltage / status / error indicator	Green LED / Yellow LED / Red LED
Output data load side	
Output voltage range	42 V AC ... 550 V AC
Load current	max. 2.4 A (see derating curve)
Surge current	100 A (t = 10 ms)
Min. load current	180 mA
Residual voltage	< 0.3 V
Output protection	Surge protection
General data	
Rated insulation voltage	500 V
Rated surge voltage	6 kV/safe isolation
Ambient temperature (operation)	6 kV/safe isolation
Electrical service life	-25°C ... 70°C
Standards/regulations	3 x 10 ⁷ cycles
Mounting position	DIN EN 50178 / EN 60947
Mounting	Vertical (horizontal DIN rail)
Connection data solid / stranded / AWG	Can be aligned with spacing = 20 mm
Dimensions	0.14 - 2.5 mm ² / 0.14 - 2.5 mm ² / 26 - 14
Safety data	22.5 mm / 99 mm / 114.5 mm
EC-type examination certificate according to ATEX	Ex II (2) G, Ex II (2) D PTB 07 ATEX 3145

Ordering data		
Type	Order No.	Pcs. / Pkt.
ELR H3-IES-SC- 24DC/500AC-0,6	2900566	1
ELR H3-IES-PT-24DC/500AC-0,6	2903914	1
ELR H3-IES-SC-230AC/500AC-0,6	2900689	1

Ordering data		
Type	Order No.	Pcs. / Pkt.
ELR H3-IES-SC- 24DC/500AC-2	2900567	1
ELR H3-IES-PT-24DC/500AC-2	2903916	1
ELR H3-IES-SC-230AC/500AC-2	2900568	1

Description
"3 in 1" hybrid motor starter, incl. right contactor, motor protection relay, and emergency stop
Screw connection
Push-in connection
Screw connection



For starting 3~ AC motors up to 550 V AC/3 x 9 A

CB Ex: Ex

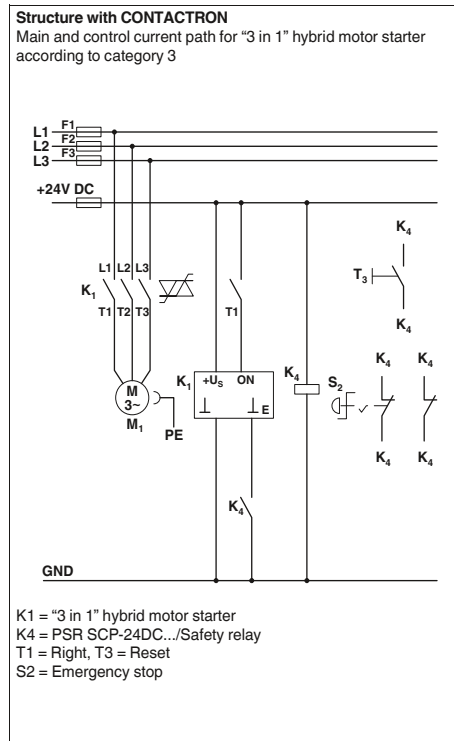

Technical data

24 V DC 0.8 ... 1.25	230 V AC (50/60 Hz) 0.4 ... 1.1
40 mA 24 V DC 0.8 ... 1.25	4 mA 230 V AC 0.4 ... 1.1
5 mA Protection against polarity reversal, Surge protection	7 mA Surge protection
Green LED / Yellow LED / Red LED	
42 V AC ... 550 V AC max. 9 A (see derating curve)	42 V AC ... 550 V AC max. 9 A (see derating curve)
100 A (t = 10 ms) 1.5 A < 0.5 V Surge protection	100 A (t = 10 ms) 1.5 A < 0.5 V Surge protection
500 V 6 kV/safe isolation -25°C ... 70°C 3 x 10 ⁷ cycles DIN EN 50178 / EN 60947 Vertical (horizontal DIN rail) Can be aligned with spacing = 20 mm 0.14 - 2.5 mm ² / 0.14 - 2.5 mm ² / 26 - 14 22.5 mm / 99 mm / 114.5 mm	6 kV/safe isolation
Ex II (2) G, Ex II (2) D PTB 07 ATEX 3145	Ex II (2) G, Ex II (2) D PTB 07 ATEX 3145

Ordering data

Type	Order No.	Pcs. / Pkt.
ELR H3-IES-SC- 24DC/500AC-9	2900569	1
ELR H3-IES-PT-24DC/500AC-9	2903918	1
ELR H3-IES-SC-230AC/500AC-9	2900570	1

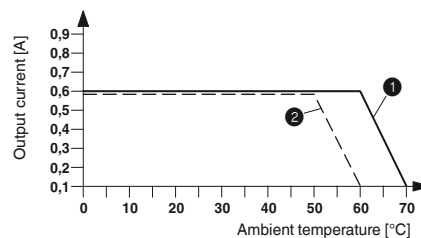
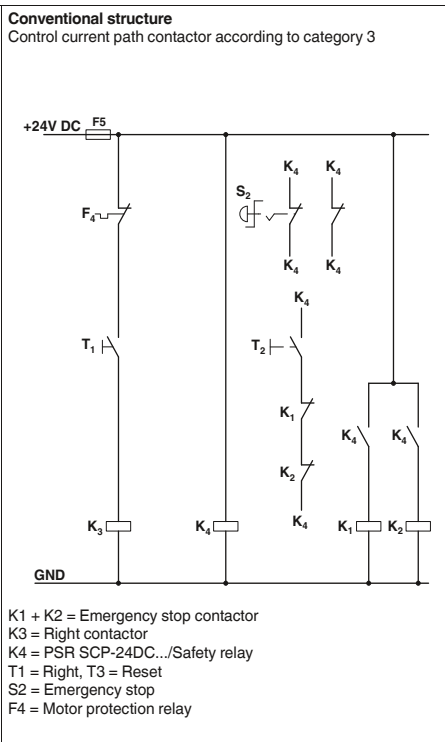

Derating curve ELR H3-IES-SC-230AC/500AC-0,6
100% operating time

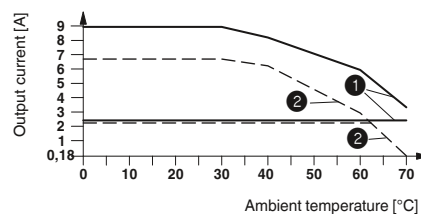

Derating curve ELR H3-IES-SC-24DC/500AC-2 and
ELR H3-IES-SC-24DC/500AC-9
100% operating time

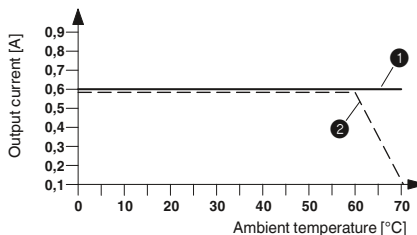

Derating curve ELR H3-IES-SC-24DC/500AC-0,6
100% operating time

- 1 Aligned with > 20 mm spacing
- 2 Aligned without spacing

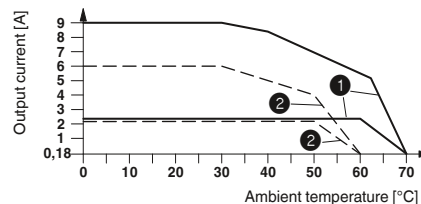

Derating curve ELR H3-IES-SC-230AC/500AC-2 and
ELR H3-IES-SC-230AC/500AC-9
100% operating time

Hybrid motor starters

"3 in 1" hybrid motor starter with reversing function and motor protection

These 3-phase "3 in 1" hybrid motor starters combine three functions in one device: right contactor, left contactor, and motor protection relay.

Offer the following advantages:

- 22.5 mm wide
- They save wiring
- Bi-metal function can be set up to 9 A
- Long service life
- Space-saving
- 3-phase loop bridging



For starting 3~ AC motors up to 550 V AC/3 x 0.6 A



For starting 3~ AC motors up to 550 V AC/3 x 2 A

Notes:
Type of housing: Polyamide PA non-reinforced, color: green.
Marking systems and mounting material See Catalog 5

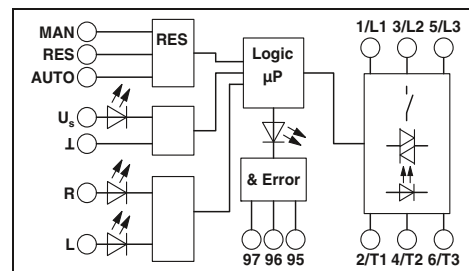
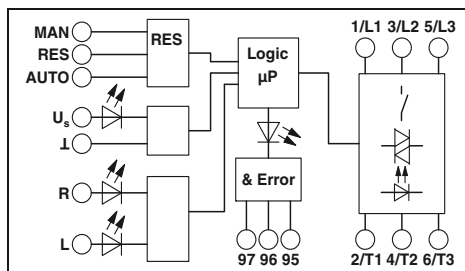

Input data	
Rated control supply voltage U_s	24 V DC
Rated control supply voltage range with reference to U_s	0.8 ... 1.25
Rated control supply current I_s at U_s	40 mA
Rated actuation voltage U_c ON	24 V DC
Rated actuating voltage range with reference to U_c	0.8 ... 1.25
Rated actuating current I_c at U_c	5 mA
Input circuit	Protection against polarity reversal, Surge protection
Operating voltage / status / error indicator	Green LED / Yellow LED / Red LED
Output data load side	
Output voltage range	42 V AC ... 550 V AC
Load current	max. 600 mA (see derating curve)
Surge current	100 A (t = 10 ms)
Min. load current	75 mA
Residual voltage	< 0.2 V
Output protection	Surge protection
General data	
Rated insulation voltage	500 V
Rated surge voltage	6 kV/safe isolation
Ambient temperature (operation)	-25°C ... 70°C
Electrical service life	3 x 10 ⁷ cycles
Standards/regulations	DIN EN 50178 / EN 60947
Mounting position	Vertical (horizontal DIN rail)
Mounting	Can be aligned with spacing = 20 mm
Screw connection solid / stranded / AWG	0.14 - 2.5 mm ² / 0.14 - 2.5 mm ² / 26 - 14
Dimensions	22.5 mm / 99 mm / 114.5 mm

Technical data

24 V DC	230 V AC (50/60 Hz)
0.8 ... 1.25	0.4 ... 1.1
40 mA	4 mA
24 V DC	230 V AC
0.8 ... 1.25	0.4 ... 1.1
5 mA	7 mA
Protection against polarity reversal, Surge protection	Surge protection

Technical data

24 V DC	230 V AC (50/60 Hz)
0.8 ... 1.25	0.4 ... 1.1
40 mA	4 mA
24 V DC	230 V AC
0.8 ... 1.25	0.4 ... 1.1
5 mA	7 mA
Protection against polarity reversal, Surge protection	Surge protection

Ordering data

Type	Order No.	Pcs. / Pkt.
ELR H5-I-SC- 24DC/500AC-0,6	2900573	1
ELR H5-I-SC-230AC/500AC-0,6	2900691	1

Ordering data

Type	Order No.	Pcs. / Pkt.
ELR H5-I-SC- 24DC/500AC-2	2900574	1
ELR H5-I-SC-230AC/500AC-2	2900575	1

Description
"3 in 1" hybrid motor starter, incl. right contactor, left contactor, and motor protection relay



For starting 3~ AC motors
up to 550 V AC/3 x 9 A

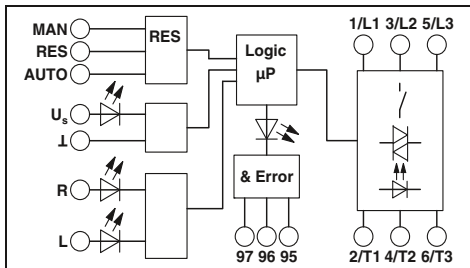

Technical data

24 V DC 0.8 ... 1.25 230 V AC (50/60 Hz) 0.4 ... 1.1

40 mA 24 V DC 0.8 ... 1.25 4 mA 230 V AC 0.4 ... 1.1

5 mA Protection against polarity reversal, Surge protection 7 mA Surge protection

Green LED / Yellow LED / Red LED

42 V AC ... 550 V AC max. 9 A (see derating curve) 42 V AC ... 550 V AC max. 9 A (see derating curve)

100 A (t = 10 ms) 1.5 A < 0.5 V Surge protection 100 A (t = 10 ms) 1.5 A < 0.5 V Surge protection

500 V 6 kV/safe isolation -25°C ... 70°C 3 x 10⁷ cycles DIN EN 50178 / EN 60947 Vertical (horizontal DIN rail) Can be aligned with spacing = 20 mm 0.14 - 2.5 mm² / 0.14 - 2.5 mm² / 26 - 14 22.5 mm / 99 mm / 114.5 mm

Ordering data

Type	Order No.	Pcs. / Pkt.
ELR H5-I-SC- 24DC/500AC-9	2900576	1
ELR H5-I-SC-230AC/500AC-9	2900578	1

Conventional structure

Main current path contactor according to category 3

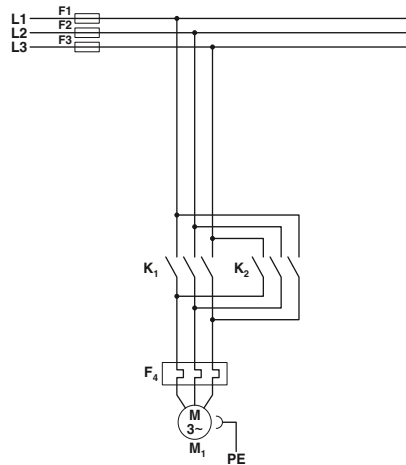

K1 = Left contactor
K2 = Right contactor
F4 = Motor protection relay

Structure with CONTACTRON

Main and control current path for "3 in 1" hybrid motor starter according to category 3

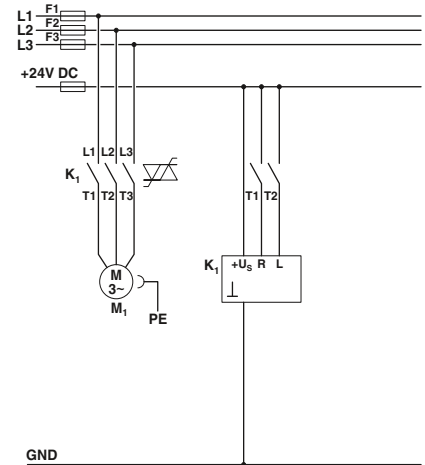

K1 = "3 in 1" hybrid motor starter
T1 = Right, T2 = Left, T3 = Reset

Conventional structure

Control current path contactor according to category 3

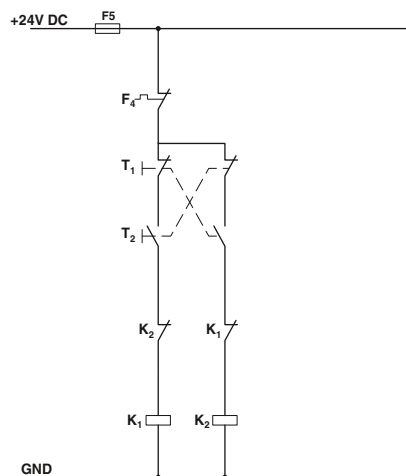

K1 = Left contactor
K2 = Right contactor
T1 = Right, T2 = Left, T3 = Reset
F4 = Motor protection relay

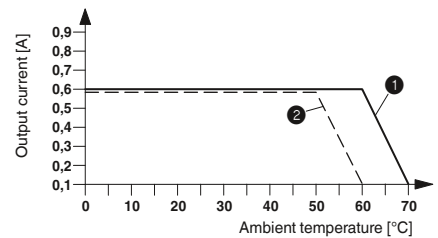

Derating curve ELR H5-I-SC-230AC/500AC-0,6
100% operating time

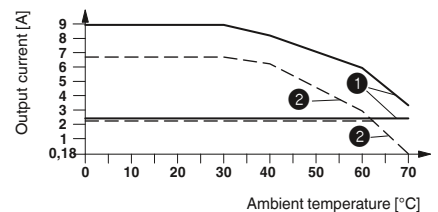

Derating curve ELR H5-I-SC-24DC/500AC-2 and
ELR H5-I-SC-24DC/500AC-99
100% operating time

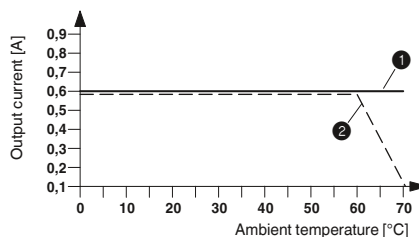

Derating curve ELR H5-I-SC-24DC/500AC-0,6
100% operating time

- ① Aligned with > 20 mm spacing
- ② Aligned without spacing

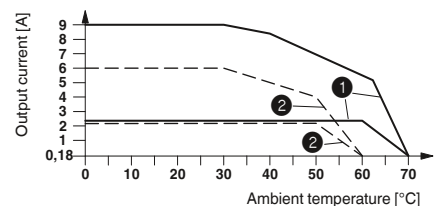

Derating curve ELR H5-I-SC-230AC/500AC-2 and
ELR H5-I-SC-230AC/500AC-9
100% operating time

Hybrid motor starters

"2 in 1" hybrid motor starter with motor protection

These 3-phase "2 in 1" hybrid motor starters combine two functions in one device: right contactor and motor protection.

The devices offer the following advantages:

- 22.5 mm wide
- They save wiring
- Bi-metal function can be set up to 9 A
- Low-wear switching
- Long service life
- Space-saving
- 3-phase loop bridging



For starting 3~ AC motors up to 550 V AC/3 x 0.6 A



For starting 3~ AC motors up to 550 V AC/3 x 2 A

Notes:
Type of housing: Polyamide PA non-reinforced, color: green.
Marking systems and mounting material See Catalog 5

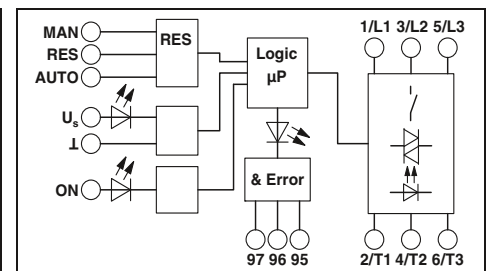

Input data	
Rated control supply voltage U_s	24 V DC
Rated control supply voltage range with reference to U_s	0.8 ... 1.25
Rated control supply current I_s at U_s	40 mA
Rated actuation voltage U_c ON	24 V DC
Rated actuating voltage range with reference to U_c	0.8 ... 1.25
Rated actuating current I_c at U_c	5 mA
Input circuit	Protection against polarity reversal, Surge protection
Operating voltage / status / error indicator	Green LED / Yellow LED / Red LED
Output data load side	
Output voltage range	42 V AC ... 550 V AC
Load current	max. 600 mA (see derating curve)
Surge current	100 A (t = 10 ms)
Min. load current	75 mA
Residual voltage	< 0.2 V
Output protection	Surge protection
General data	
Rated insulation voltage	500 V
Rated surge voltage	6 kV/safe isolation
Ambient temperature (operation)	-25°C ... 70°C
Electrical service life	3 x 10 ⁷ cycles
Standards/regulations	DIN EN 50178 / EN 60947
Mounting position	Vertical (horizontal DIN rail)
Mounting	Can be aligned with spacing = 20 mm
Screw connection solid / stranded / AWG	0.14 - 2.5 mm ² / 0.14 - 2.5 mm ² / 26 - 14
Dimensions	22.5 mm / 99 mm / 114.5 mm

Technical data	
Rated control supply voltage U_s	230 V AC (50/60 Hz)
Rated control supply voltage range with reference to U_s	0.4 ... 1.1
Rated control supply current I_s at U_s	4 mA
Rated actuation voltage U_c ON	230 V AC
Rated actuating voltage range with reference to U_c	0.4 ... 1.1
Rated actuating current I_c at U_c	7 mA
Input circuit	Surge protection
Operating voltage / status / error indicator	Green LED / Yellow LED / Red LED
Output data load side	
Output voltage range	42 V AC ... 550 V AC
Load current	max. 600 mA (see derating curve)
Surge current	100 A (t = 10 ms)
Min. load current	75 mA
Residual voltage	< 0.2 V
Output protection	Surge protection
General data	
Rated insulation voltage	500 V
Rated surge voltage	6 kV/safe isolation
Ambient temperature (operation)	-25°C ... 70°C
Electrical service life	3 x 10 ⁷ cycles
Standards/regulations	DIN EN 50178 / EN 60947
Mounting position	Vertical (horizontal DIN rail)
Mounting	Can be aligned with spacing = 20 mm
Screw connection solid / stranded / AWG	0.14 - 2.5 mm ² / 0.14 - 2.5 mm ² / 26 - 14
Dimensions	22.5 mm / 99 mm / 114.5 mm

Technical data	
Rated control supply voltage U_s	230 V AC (50/60 Hz)
Rated control supply voltage range with reference to U_s	0.4 ... 1.1
Rated control supply current I_s at U_s	40 mA
Rated actuation voltage U_c ON	230 V AC
Rated actuating voltage range with reference to U_c	0.4 ... 1.1
Rated actuating current I_c at U_c	7 mA
Input circuit	Protection against polarity reversal, Surge protection
Operating voltage / status / error indicator	Green LED / Yellow LED / Red LED
Output data load side	
Output voltage range	42 V AC ... 550 V AC
Load current	max. 2.4 A (see derating curve)
Surge current	100 A (t = 10 ms)
Min. load current	180 mA
Residual voltage	< 0.3 V
Output protection	Surge protection
General data	
Rated insulation voltage	500 V
Rated surge voltage	6 kV/safe isolation
Ambient temperature (operation)	-25°C ... 70°C
Electrical service life	3 x 10 ⁷ cycles
Standards/regulations	DIN EN 50178 / EN 60947
Mounting position	Vertical (horizontal DIN rail)
Mounting	Can be aligned with spacing = 20 mm
Screw connection solid / stranded / AWG	0.14 - 2.5 mm ² / 0.14 - 2.5 mm ² / 26 - 14
Dimensions	22.5 mm / 99 mm / 114.5 mm

Ordering data	
Type	Order No.
ELR H3-I-SC- 24DC/500AC-0,6	2900542
ELR H3-I-SC-230AC/500AC-0,6	2900685

Ordering data	
Type	Order No.
ELR H3-I-SC- 24DC/500AC-2	2900543
ELR H3-I-SC-230AC/500AC-2	2900544

Ordering data	
Type	Order No.
ELR H3-I-SC- 24DC/500AC-2	2900543
ELR H3-I-SC-230AC/500AC-2	2900544



For starting 3~ AC motors
up to 550 V AC/3 x 9 A

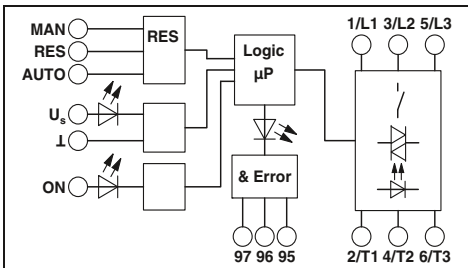

Technical data

24 V DC
0.8 ... 1.25

230 V AC (50/60 Hz)
0.4 ... 1.1

40 mA
24 V DC
0.8 ... 1.25

4 mA
230 V AC
0.4 ... 1.1

5 mA
Protection against polarity reversal, Surge protection

7 mA
Surge protection

Green LED / Yellow LED / Red LED

42 V AC ... 550 V AC
max. 9 A
(see derating curve)

42 V AC ... 550 V AC
max. 9 A
(see derating curve)

100 A (t = 10 ms)
1.5 A
< 0.5 V

100 A (t = 10 ms)
1.5 A
< 0.5 V

Surge protection

500 V
6 kV/safe isolation

6 kV/safe isolation

-25°C ... 70°C
3 x 10⁷ cycles
DIN EN 50178 / EN 60947
Vertical (horizontal DIN rail)
Can be aligned with spacing = 20 mm
0.14 - 2.5 mm² / 0.14 - 2.5 mm² / 26 - 14
22.5 mm / 99 mm / 114.5 mm

Ordering data

Type	Order No.	Pcs. / Pkt.
ELR H3-I-SC- 24DC/500AC-9	2900545	1
ELR H3-I-SC-230AC/500AC-9	2900546	1

Conventional structure

Main current path reversing contactor according to category 3

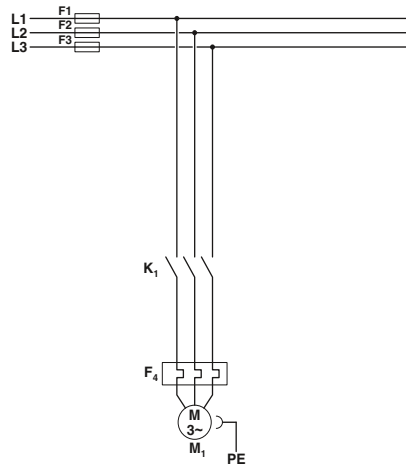

K1 = Right contactor
F4 = Motor protection relay

Conventional structure

Control current path contactor according to category 3

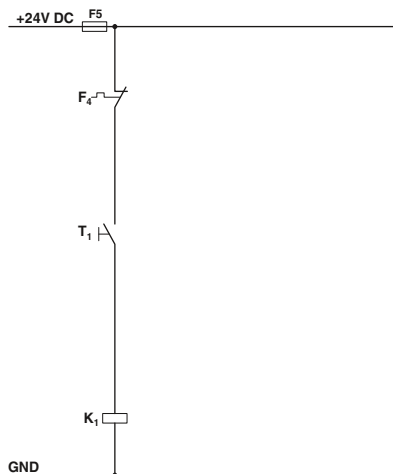

K1 = Right contactor
T1 = Right, T3 = Reset
F4 = Motor protection relay

Structure with CONTACTRON

Main and control current path for "2 in 1" hybrid motor starter according to category 3

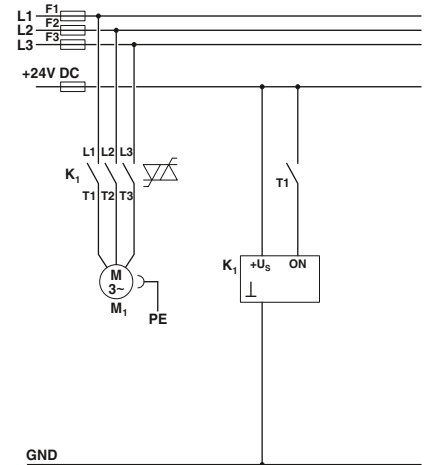

K1 = "2 in 1" hybrid motor starter
T1 = Right, T3 = Reset

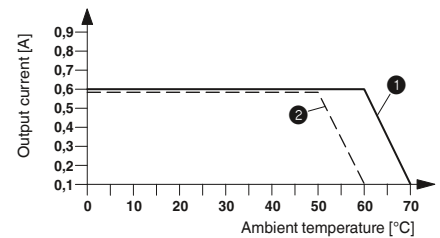

Derating curve ELR H3-I-SC-230AC/500AC-0,6
100% operating time

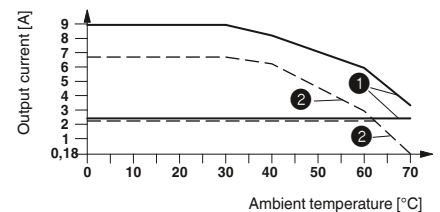

Derating curve ELR H3-I-SC-24DC/500AC-2 and
ELR H3-I-SC-24DC/500AC-9
100% operating time

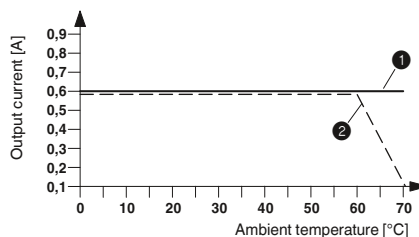

Derating curve ELR H3-I-SC-24DC/500AC-0,6
100% operating time

- ① Aligned with > 20 mm spacing
- ② Aligned without spacing

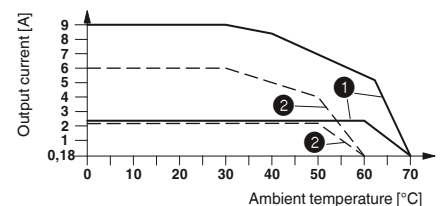

Derating curve ELR H3-I-SC-230AC/500AC-2 and
ELR H3-I-SC-230AC/500AC-9
100% operating time

Hybrid motor starters

"2 in 1" hybrid motor starter with reversing function

3-phase hybrid motor starter for reversing three-phase induction motors

The devices offer the following advantages:

- 22.5 mm wide
- They save wiring
- Up to 9 A
- Low-wear switching
- Long service life
- Space-saving
- 3-phase loop bridging

Notes:

Type of housing:
Polyamide PA non-reinforced, color: green.

Marking systems and mounting material
See Catalog 5



For reversing 3~ AC motors
up to 550 V AC/3 x 9 A

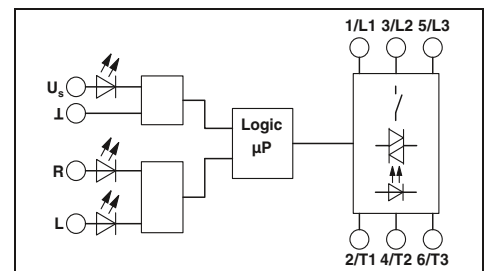

Technical data

Input data	24 V DC	230 V AC (50/60 Hz)
Rated control supply voltage U_s	24 V DC	230 V AC (50/60 Hz)
Rated control supply voltage range with reference to U_s	0.8 ... 1.25	0.4 ... 1.1
Rated control supply current I_s at U_s	40 mA	4 mA
Rated actuating voltage U_c R/L	24 V DC	230 V AC
Rated actuating voltage range with reference to U_c	0.8 ... 1.25	0.4 ... 1.1
Rated actuating current I_c at U_c	5 mA	7 mA
Input circuit	Protection against polarity reversal, Surge protection	Surge protection
Operating voltage / status / error indicator	Green LED / Yellow LED / Red LED	
Output data load side	42 V AC ... 550 V AC	42 V AC ... 550 V AC
Output voltage range	max. 9 A	max. 9 A
Load current	(see derating curve)	(see derating curve)
Surge current	100 A (t = 10 ms)	100 A (t = 10 ms)
Minimum load current	0 A	0 A
Residual voltage	< 0.5 V	< 0.5 V
Output protection	Surge protection	
General data	500 V	6 kV/safe isolation
Rated insulation voltage	6 kV/safe isolation	6 kV/safe isolation
Rated surge voltage	-25°C ... 70°C	
Ambient temperature (operation)	3 x 10 ⁷ cycles	
Electrical service life	DIN EN 50178 / EN 60947	
Standards/regulations	Vertical (horizontal DIN rail)	
Mounting position	Can be aligned with spacing = 20 mm	
Mounting	0.14 - 2.5 mm ² / 0.14 - 2.5 mm ² / 26 - 14	
Screw connection solid / stranded / AWG	22.5 mm / 99 mm / 114.5 mm	
Dimensions	W / H / D	

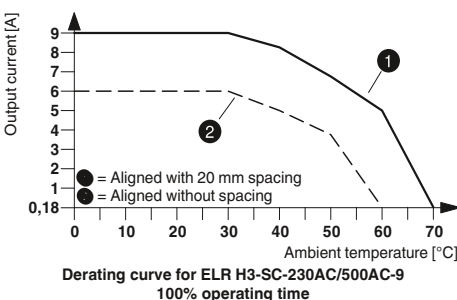
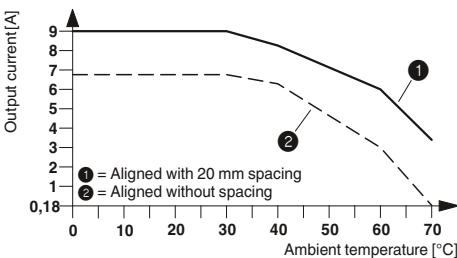

Description

"2 in 1" hybrid motor starter, incl. right contactor and left contactor

Ordering data

Type	Order No.	Pcs. / Pkt.
ELR H5-SC- 24DC/500AC-9	2900538	1
ELR H5-SC-230AC/500AC-9	2900539	1

“1 in 1” hybrid motor starter

3-phase hybrid motor starter for starting three-phase induction motors

The devices offer the following advantages:

- 22.5 mm wide
- Low-wear switching
- Up to 9 A
- Long service life
- Space-saving
- 3-phase loop bridging

Notes:
Type of housing: Polyamide PA non-reinforced, color: green.
Marking systems and mounting material See Catalog 5



For starting 3~ AC motors up to 550 V AC/3 x 9 A

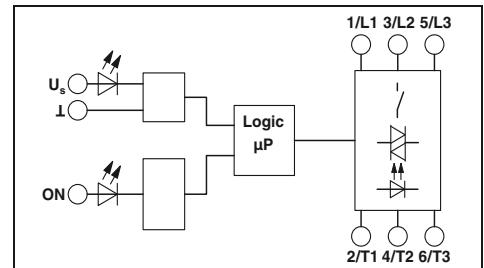

Technical data

Input data		
Rated control supply voltage U_s	24 V DC	230 V AC (50/60 Hz)
Rated control supply voltage range with reference to U_s	0.8 ... 1.25	0.4 ... 1.1
Rated control supply current I_s at U_s	40 mA	4 mA
Rated actuation voltage U_c ON	24 V DC	230 V AC
Rated actuating voltage range with reference to U_c	0.8 ... 1.25	0.4 ... 1.1
Rated actuating current I_c at U_c	5 mA	7 mA
Input circuit	Protection against polarity reversal, Surge protection	Surge protection
Operating voltage / status / error indicator	Green LED / Yellow LED / Red LED	
Output data load side		
Output voltage range	42 V AC ... 550 V AC	42 V AC ... 550 V AC
Load current	max. 9 A (see derating curve)	max. 9 A (see derating curve)
Surge current	100 A (t = 10 ms)	100 A (t = 10 ms)
Minimum load current	0 A	0 A
Residual voltage	< 0.5 V	< 0.5 V
Output protection	Surge protection	
General data		
Rated insulation voltage	500 V	
Rated surge voltage	6 kV/safe isolation	6 kV/safe isolation
Ambient temperature (operation)	-25°C ... 70°C	
Electrical service life	3 x 10 ⁷ cycles	
Standards/regulations	DIN EN 50178 / EN 60947	
Mounting	Can be aligned with spacing = 20 mm	
Screw connection solid / stranded / AWG	0.14 - 2.5 mm ² / 0.14 - 2.5 mm ² / 26 - 14	
Dimensions	22.5 mm / 99 mm / 114.5 mm	W / H / D
Description	“1 in 1” hybrid motor starter, incl. right contactor	

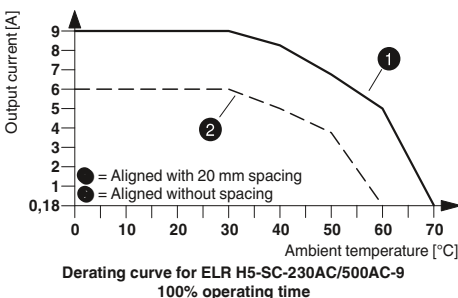
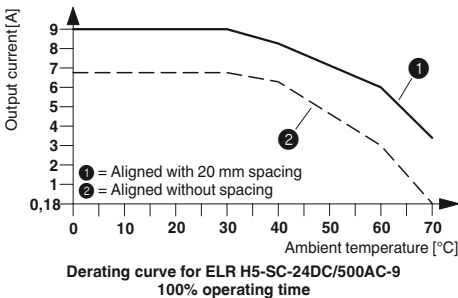

Ordering data

Type	Order No.	Pcs. / Pkt.
ELR H3-SC- 24DC/500AC-9	2900530	1
ELR H3-SC-230AC/500AC-9	2900531	1

CONTACTRON hybrid motor starters with short-circuit protection



These short-circuit-proof 3-phase “4 in 1” hybrid motor starters for mounting on 30 mm DIN rails or 60 mm busbars combine four functions in one device: right contactor, left contactor, motor protection relay, and emergency stop up to category 3.

- Offer the following advantages:
- 22.5 mm wide
 - Bi-metal function can be set up to 9 A
 - Long service life
 - Space-saving
 - They save wiring
 - 3-phase loop bridging
 - Coordination type 2 according to IEC/EN 60947-4-2

Input data

Rated control supply voltage U_s
Rated control supply voltage range with reference to U_s

Rated control supply current I_s at U_s
Rated actuating voltage U_c R/L
Rated actuating voltage range with reference to U_c

Rated actuating current I_c at U_c
Input circuit
Operating voltage / status / error indicator

Output data load side

Output voltage range
Load current

Minimum load current
Residual voltage
Output protection

General data

Rated insulation voltage
Rated surge voltage
Ambient temperature (operation)
Electrical service life
Standards/regulations

Mounting position
Mounting
Screw connection solid / stranded / AWG
Dimensions

W / H / D

Description

Short-circuit-proof hybrid motor starters

Hybrid motor starters
DIN rail adapter
Power rail adapter, 160 mm
Power rail adapter, 200 mm
Set consisting of short-circuit-proof hybrid motor starter and DIN rail adapter

Fuse

Coordination type 2 to 10 kA/500 V
Coordination type 2 to 5 kA/400 V
Coordination type 1 to 30 kA/500 V



For reversing 3~ AC motors up to 550 V AC/3 x 0.6 A



For reversing 3~ AC motors up to 550 V AC/3 x 2.4 A



For reversing 3~ AC motors up to 550 V AC/3 x 9 A

Ex:

Ex:

Ex:



Technical data

Technical data

Technical data

24 V DC
0.8 ... 1.25

40 mA
24 V DC
0.8 ... 1.25

5 mA
Protection against polarity reversal, Surge protection
Green LED / Yellow LED / Red LED

42 V AC ... 550 V AC
max. 600 mA

75 mA
< 0.3 V
Surge protection, short-circuit protection

500 V
6 kV/safe isolation
-25°C ... 70°C
3 x 10⁷ cycles
DIN EN 50178 / EN 60947
Vertical (horizontal DIN rail)
Can be aligned with spacing = 20 mm
0.14 - 2.5 mm² / 0.14 - 2.5 mm² / 26 - 14
22.5 mm / 160 mm / 114.5 mm

24 V DC
0.8 ... 1.25

40 mA
24 V DC
0.8 ... 1.25

5 mA
Protection against polarity reversal, Surge protection
Green LED / Yellow LED / Red LED

42 V AC ... 550 V AC
max. 2.4 A

180 mA
< 0.4 V
Surge protection, short-circuit protection

500 V
6 kV/safe isolation
-25°C ... 70°C
3 x 10⁷ cycles
DIN EN 50178 / EN 60947
Vertical (horizontal DIN rail)
Can be aligned with spacing = 20 mm
0.14 - 2.5 mm² / 0.14 - 2.5 mm² / 26 - 14
22.5 mm / 160 mm / 114.5 mm

24 V DC
0.8 ... 1.25

40 mA
24 V DC
0.8 ... 1.25

5 mA
Protection against polarity reversal, Surge protection
Green LED / Yellow LED / Red LED

42 V AC ... 550 V AC
max. 9 A

1.5 A
< 0.6 V
Surge protection, short-circuit protection

500 V
6 kV/safe isolation
-25°C ... 70°C
3 x 10⁷ cycles
DIN EN 50178 / EN 60947
Vertical (horizontal DIN rail)
Can be aligned with spacing = 20 mm
0.14 - 2.5 mm² / 0.14 - 2.5 mm² / 26 - 14
22.5 mm / 160 mm / 114.5 mm

Ordering data

Ordering data

Ordering data

Type	Order No.	Pcs. / Pkt.
ELR H51-IESSC-24DC500AC-06	2902746	1
EM RD-ADAPTER	2902747	1
EM RI-ADAPTER COMPACT	2902748	1
EM RI-ADAPTER CLASSIC	2902831	1
ELR H51-0.6-DIN-RAIL-SET	2902952	1

Type	Order No.	Pcs. / Pkt.
ELR H51-IESSC-24DC500AC-2	2902744	1
EM RD-ADAPTER	2902747	1
EM RI-ADAPTER COMPACT	2902748	1
EM RI-ADAPTER CLASSIC	2902831	1
ELR H51-2.4-DIN-RAIL-SET	2902953	1

Type	Order No.	Pcs. / Pkt.
ELR H51-IESSC-24DC500AC-9	2902745	1
EM RD-ADAPTER	2902747	1
EM RI-ADAPTER COMPACT	2902748	1
EM RI-ADAPTER CLASSIC	2902831	1
ELR H51-9-DIN-RAIL-SET	2902954	1

Accessories

Accessories

Accessories

Type	Order No.	Pcs. / Pkt.
FUSE-10X38-16A-GR	2903126	10
FUSE-10X38-20A-GR	2903384	10
FUSE-10X38-30A-MR	2903119	10

Type	Order No.	Pcs. / Pkt.
FUSE-10X38-16A-GR	2903126	10
FUSE-10X38-20A-GR	2903384	10
FUSE-10X38-30A-MR	2903119	10

Type	Order No.	Pcs. / Pkt.
FUSE-10X38-16A-GR	2903126	10
FUSE-10X38-20A-GR	2903384	10
FUSE-10X38-30A-MR	2903119	10

Hybrid motor starters

CONTACTRON hybrid motor starters with SmartWire-DT™ support



Switch and reverse motors safely and reliably with CONTACTRON compact hybrid motor starters. The CONTACTRON “4 in 1” combines all the functions of a conventional reversing contactor circuit in a single device – for motors up to 4 kW, with a design width of just 22.5 mm.

The SmartWire-DT™ communication system makes the complex cabling of the control and signal levels easier and clearer. You can also combine the hybrid motor starters with standard fieldbus systems.

The hybrid motor starters, as well as the command and signaling devices, are directly connected to the controller with SmartWire-DT™ via a gateway. Safe shutdown is implemented with a PSR safety relay. Thanks to SmartWire-DT™, the amount of wiring is significantly reduced. You benefit from clearly arranged and compact control cabinets.

Notes:

Switching device technical data

You can download the **SmartWire-DT™ Assist** software for easy creation of SmartWire-DT™ networks free of charge at www.phoenixcontact.com

SmartWire-DT™ is a registered trademark of Eaton Corporation.

Input data

Rated control supply voltage U_S
Rated control supply voltage range with reference to U_S

Rated control supply current I_S at U_S
Rated actuating voltage U_C R/L
Rated actuating voltage range with reference to U_C

Rated actuating current I_C at U_C
Input circuit
Operating voltage / status / error indicator

Output data load side

Output voltage range
Load current

Surge current
Minimum load current
Residual voltage
Output protection

General data

Rated insulation voltage
Rated surge voltage
Ambient temperature (operation)
Electrical service life
Standards/regulations
Mounting position
Mounting
Screw connection solid / stranded / AWG
Dimensions (including adapter) W / H / D

Safety data

EC-type examination certificate according to ATEX

Description

Reversing starter + emergency stop + motor protection + SmartWire-DT™ adapter as a set



Reversing starter + emergency stop + motor protection + SmartWire-DT™ adapter, as a set
550 V AC/3 x 0.6 A

Reversing starter + emergency stop + motor protection + SmartWire-DT™ adapter, as a set
550 V AC/3 x 2.4 A

Reversing starter + emergency stop + motor protection + SmartWire-DT™ adapter, as a set
550 V AC/3 x 9 A

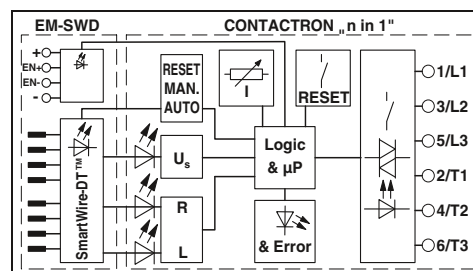
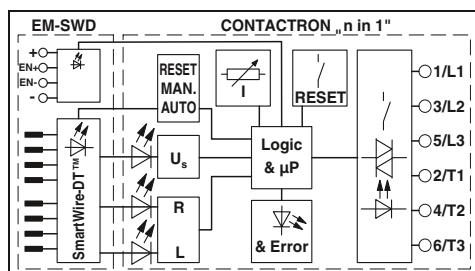

Technical data

24 V DC
0.8 ... 1.25

40 mA
24 V DC
0.8 ... 1.25

5 mA
Protection against polarity reversal, Surge protection
Green LED / Yellow LED / Red LED

42 V AC ... 550 V AC
max. 600 mA (see derating curve)

100 A (t = 10 ms)
75 mA
< 0.2 V
Surge protection

500 V
6 kV/safe isolation
-25°C ... 70°C
3 x 10⁷ cycles
DIN EN 50178 / EN 60947
Vertical (horizontal DIN rail)
Can be aligned with spacing = 20 mm
0.14 - 2.5 mm² / 0.14 - 2.5 mm² / 26 - 14
22.5 mm / 165 mm / 114.5 mm

Ex II (2) G, Ex II (2) D
PTB 07 ATEX 3145

Technical data

24 V DC
0.8 ... 1.25

40 mA
24 V DC
0.8 ... 1.25

5 mA
Protection against polarity reversal, Surge protection
Green LED / Yellow LED / Red LED

42 V AC ... 550 V AC
max. 2.4 A (see derating curve)

100 A (t = 10 ms)
180 mA
< 0.3 V
Surge protection

500 V
6 kV/safe isolation
-25°C ... 70°C
3 x 10⁷ cycles
DIN EN 50178 / EN 60947
Vertical (horizontal DIN rail)
Can be aligned with spacing = 20 mm
0.14 - 2.5 mm² / 0.14 - 2.5 mm² / 26 - 14
22.5 mm / 165 mm / 114.5 mm

Ex II (2) G, Ex II (2) D
PTB 07 ATEX 3145

Technical data

24 V DC
0.8 ... 1.25

40 mA
24 V DC
0.8 ... 1.25

5 mA
Protection against polarity reversal, Surge protection
Green LED / Yellow LED / Red LED

42 V AC ... 550 V AC
max. 9 A (see derating curve)

100 A (t = 10 ms)
1.5 A
< 0.5 V
Surge protection

500 V
6 kV/safe isolation
-25°C ... 70°C
3 x 10⁷ cycles
DIN EN 50178 / EN 60947
Vertical (horizontal DIN rail)
Can be aligned with spacing = 20 mm
0.14 - 2.5 mm² / 0.14 - 2.5 mm² / 26 - 14
22.5 mm / 165 mm / 114.5 mm

Ex II (2) G, Ex II (2) D
PTB 07 ATEX 3145

Ordering data

Type	Order No.	Pcs. / Pkt.
ELR H5-IES-SC-SWD/500AC-0,6	2903116	1

Ordering data

Type	Order No.	Pcs. / Pkt.
ELR H5-IES-SC-SWD/500AC-2	2903117	1

Ordering data

Type	Order No.	Pcs. / Pkt.
ELR H5-IES-SC-SWD/500AC-9	2903118	1

Hybrid motor starters

SmartWire-DT™ accessories

With the “EM SWD-ADAPTER” SmartWire-DT™ adapter for the CONTACTRON 24 V DC “n in 1” devices, the device concerned can be seamlessly integrated into the fieldbus environment using SmartWire-DT™. Corresponding gateways are available for the following bus systems:

- PROFIBUS-DP
- CANopen
- Modbus TCP/Ethernet IP



SmartWire DT adapter

		Technical data		
Input data				
Supply voltage U_{AUX}		-		
Rated current I_{AUX}		-		
Supply voltage U_{POW}		-		
Rated current I_{POW}		-		
Input data				
Description		Enable input		
Input voltage		24 V DC		
Input current		5 mA		
Output data				
Description		-		
Output supply		-		
Output current		-		
SmartWire-DT interface				
Connection method		Pin strip, 8-pos.		
Data rate		125 kBd / 250 kBd		
Current consumption I_{AUX}		120 mA		
Current consumption I_{POW}		25 mA		
General data				
Ambient temperature (operation)		-25°C ... 55°C		
Standards/regulations		IEC 60947-1 / EN 60947-1		
Degree of protection according to IEC 60529/ EN 60529		IP20		
Mounting position		Any		
Mounting		On CONTACTRON hybrid motor starter		
Connection data solid / stranded / AWG		0.14 - 1 mm ² / 0.14 - 1 mm ² / 26 - 18		
Dimensions	W / H / D	22.5 mm / 165 mm / 114.5 mm		
		Ordering data		
Description		Type	Order No.	Pcs. / Pkt.
SmartWire-DT™ adapter		EM SWD-ADAPTER	2902776	1
Gateways				
CANopen®				
PROFIBUS				
Ethernet				
I/O modules				
Digital, 4 inputs, 4 outputs				
Digital, 4 inputs				
Digital, 8 outputs				
Analog, 2 inputs, 2 outputs				
Power feed module for supplying further SmartWire-DT™ devices				



Gateways



Input/output modules



Power feed



Technical data	
-	-
24 V DC -15% ... +20%	-
3 A	-
24 V DC -15% ... +20%	-
700 mA	-
-	-
-	-
-	-
-	-
-	-
Pin strip, 8-pos. 125 kBd / 250 kBd	-
-	-
-	-
-25°C ... 55°C	-
EN 50178	-
IP20	-
Any	-
-	-
0.2 - 1.5 mm ² / 0.2 - 1.5 mm ² / 24 - 16	-
35 mm / 90 mm / 127 mm	-

Technical data	
-	-
-	-
-	-
-	-
-	-
-	-
Digital inputs	Analog inputs
24 V DC	-
Typ. 4 mA	-
-	-
-	-
Digital outputs	Analog outputs
24 V DC -15% ... +20%	-
Typ. 500 mA	-
-	-
-	-
Pin strip, 8-pos. 125 kBd / 250 kBd	Pin strip, 8-pos. 125 kBd / 250 kBd
-	-
-	-
-	-
-	-
EN 50178	-
IP20	-
Any	-
-	-
0.2 - 1.5 mm ² / 0.2 - 1.5 mm ² / 24 - 16	-
35 mm / 90 mm / 101 mm	-

Technical data	
-	-
24 V DC -15% ... +20%	-
3 A	-
24 V DC -15% ... +20%	-
700 mA	-
-	-
-	-
-	-
-	-
-	-
Pin strip, 8-pos. 125 kBd / 250 kBd	-
-	-
-	-
-	-
EN 50178	-
IP20	-
Any	-
-	-
0.2 - 1.5 mm ² / 0.2 - 1.5 mm ² / 24 - 16	-
35 mm / 90 mm / 124 mm	-

Ordering data		
Type	Order No.	Pcs. / Pkt.
EU5C-SWD-CAN PXC	2903098	1
EU5C-SWD-DP PXC	2903100	1
EU5C-SWD-EIP-MODTCP PXC	2903244	1

Ordering data		
Type	Order No.	Pcs. / Pkt.
EU5E-SWD-4D4D PXC	2903101	1
EU5E-SWD-4DX PXC	2903102	1
EU5E-SWD-X8D PXC	2903103	1
EU5E-SWD-2A2A PXC	2903104	1

Ordering data		
Type	Order No.	Pcs. / Pkt.
EU5C-SWD-PF2-1 PXC	2903113	1

Electronic switchgear and motor control

Hybrid motor starters

SmartWire-DT™ accessories



Plug tools



Flat-ribbon cable, 8-pos.

		Ordering data			Ordering data		
Description	Color	Type	Order No.	Pcs. / Pkt.	Type	Order No.	Pcs. / Pkt.
Pliers for device plugs		SWD4-CRP-1 PXC	2903110	1			
Pliers for flat plugs		SWD4-CRP-2 PXC	2903114	1			
Flat-ribbon cable, 8-pos., 100 m					SWD4-100LF-8-24 PXC	2903111	1
Flat-ribbon cable, assembled with 2 flat plugs, 8-pos., 3 m					SWD4-3LF8-24-2S PXC	2903112	1

SmartWire-DT™ accessories

Accessories for SmartWire-DT™ and SmartWire-DT™ devices for connecting digital and analog input and output signals.



Plug and coupler



Programming adapter

		Ordering data			Ordering data		
Description	Color	Type	Order No.	Pcs. / Pkt.	Type	Order No.	Pcs. / Pkt.
Plug and coupling							
Network dummy plug		SWD4-RC8-10 PXC	2903106	1			
Device plug, 8-pos.		SWD4-8SF2-5 PXC	2903107	10			
Flat plug, 8-pos.		SWD4-8MF2 PXC	2903108	10			
Coupling for 8-pos. flat plug		SWD4-8SFF2-5 PXC	2903109	1			
Programming adapter							
					EU4A-RJ45-USB-CAB1 PXC	2903465	1

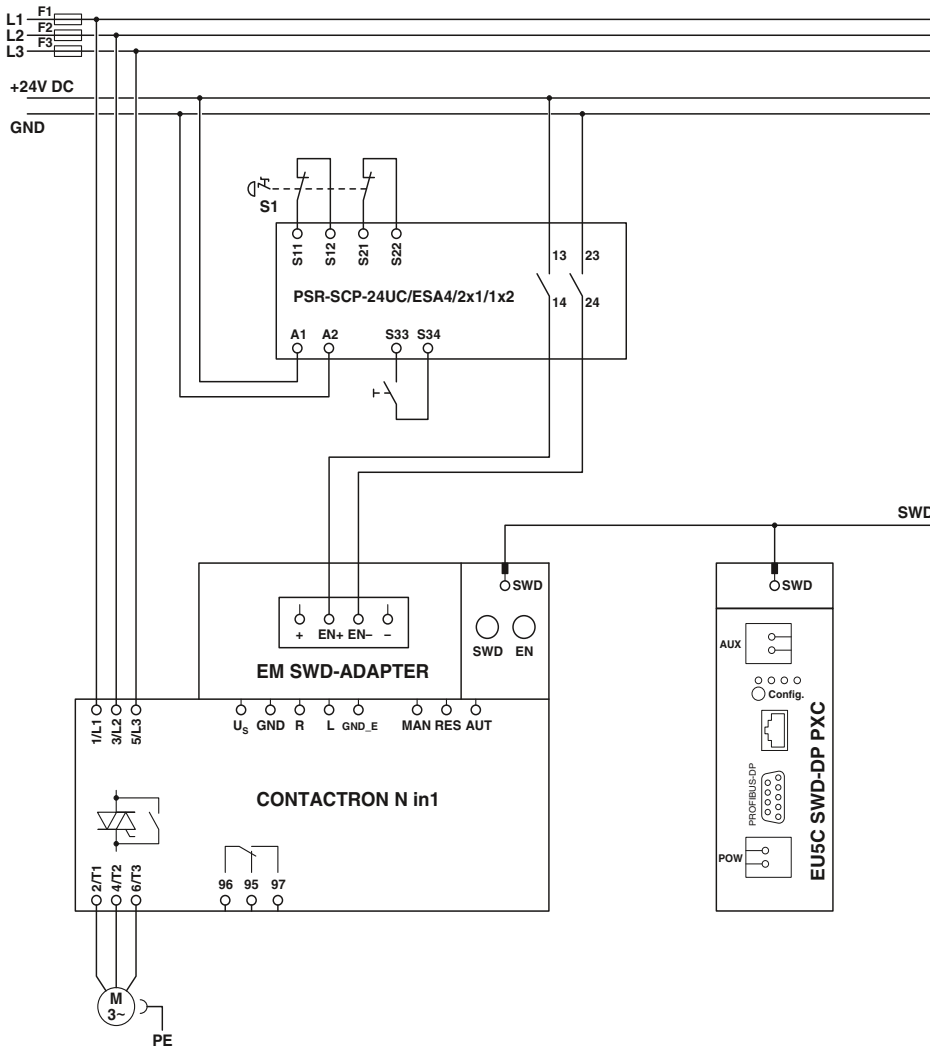

Emergency stop wiring example (two-channel)

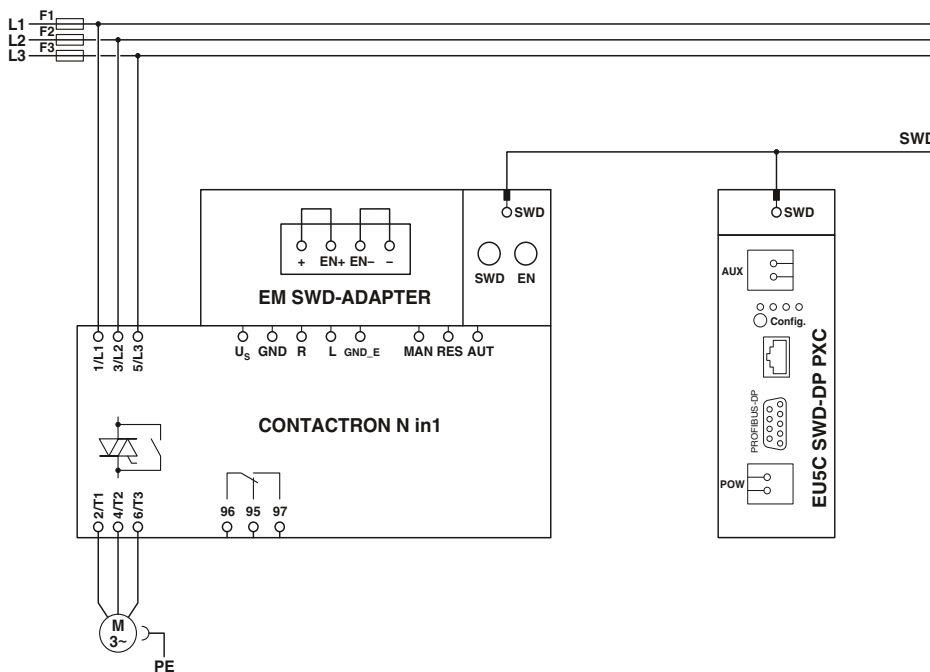

Wiring example without emergency stop

Intended use
The SmartWire-DT™ adapter is approved exclusively for use in conjunction with the following CONTACTRON hybrid motor starters. If other switching devices are used, correct operation, in particular of the safety function, cannot be ensured.

Motor protection and safe shutdown

2900582	ELR H5-IES-SC-24DC/500AC-0,6
2900414	ELR H5-IES-SC-24DC/500AC-2
2900421	ELR H5-IES-SC-24DC/500AC-9
2900566	ELR H3-IES-SC-24DC/500AC-0,6
2900567	ELR H3-IES-SC-24DC/500AC-2
2900569	ELR H3-IES-SC-24DC/500AC-9
2297031	ELR W3- 24DC/500AC-2I
2297057	ELR W3- 24DC/500AC-9I
2902952	ELR H51-0,6-DINRAIL-SET
2902953	ELR H51-2,4-DINRAIL-SET
2902954	ELR H51-9-DINRAIL-SET
2902746	ELR H51-IESSC-24DC500AC-06
2902744	ELR H51-IESSC-24DC500AC-2
2902745	ELR H51-IESSC-24DC500AC-9

Motor protection only

2900573	ELR H5-I-SC-24DC/500AC-0,6
2900574	ELR H5-I-SC-24DC/500AC-2
2900576	ELR H5-I-SC-24DC/500AC-9
2900542	ELR H3-I-SC-24DC/500AC-0,6
2900543	ELR H3-I-SC-24DC/500AC-2
2900545	ELR H3-I-SC-24DC/500AC-9

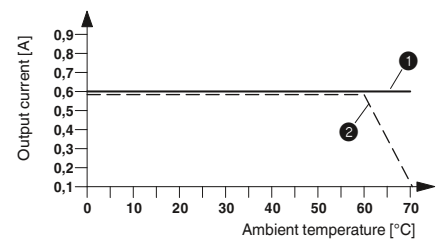

Derating curve for ELR H5-IES-SC-SWD/500AC-0,6
100% operating time

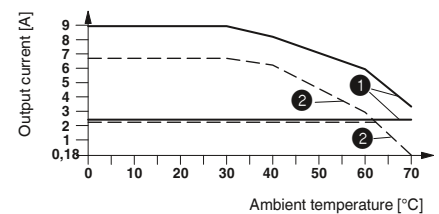

Derating curve for ELR H5-IES-SC-SWD/500AC-2 and ELR H5-IES-SC-SWD/500AC-9
100% operating time

- ① Aligned with > 20 mm spacing
- ② Aligned without spacing

CONTACTRON bridge

The flexible CONTACTRON loop bridge (BRIDGE-...) simplifies the supply and looping through of phases L1, L2, and L3. It is available in 2- to 10-way versions for modules in the CONTACTRON family with 22.5 mm housing width.

Features of the 3-phase loop bridge:

- Saves considerable wiring
- Suitable for CONTACTRON series
 - ELR H3...
 - ELR H5...
 - ELR (W)3...
 - EMM...IFS
- Bridging of 2 to 10 devices with maximum module spacing of 22.5 mm
- Up to 575 V AC/3 x 25 A
- Additional bridge versions available on request



0.3 m connecting cable with ferrules

General data		Technical data		
Nominal voltage U_N		575 V AC		
Nominal current at U_N		25 A		
Cross section		2.5 mm ²		
Description		Ordering data		
3-phase loop bridge		Type	Order No.	Pcs. / Pkt.
2-way		BRIDGE- 2	2900746	1
3-way		BRIDGE- 3	2900747	1
4-way		BRIDGE- 4	2900748	1
5-way		BRIDGE- 5	2900749	1
6-way		BRIDGE- 6	2900750	1
7-way		BRIDGE- 7	2900751	1
8-way		BRIDGE- 8	2900752	1
9-way		BRIDGE- 9	2900753	1
10-way		BRIDGE-10	2900754	1



N



3 m connecting cable
without ferrules

Technical data

575 V AC
25 A
2.5 mm²

Ordering data

Type	Order No.	Pcs. / Pkt.
BRIDGE- 2-3M	2901543	1
BRIDGE- 3-3M	2901656	1
BRIDGE- 4-3M	2901659	1
BRIDGE- 5-3M	2901545	1
BRIDGE- 6-3M	2901697	1
BRIDGE- 7-3M	2901698	1
BRIDGE- 8-3M	2901700	1
BRIDGE- 9-3M	2901701	1
BRIDGE-10-3M	2901702	1

Solid-state contactors

Three-phase solid-state reversing contactors

The three-phase solid-state reversing contactor with an integrated locking circuit and load wiring are intended for applications such as control valves, slides, separating filters, ship steering gears, etc. The scope of performance ranges from 575 V AC/3 x 2 A to 575 V AC/3 x 37 A.

Advantages of three-phase solid-state reversing contactors:

- Noise-free and wear-free switching
- Integrated protective circuit
- Stable and short switching times
- Long service life
- High switching frequency
- Integrated locking and load wiring
- Thermal fuse optional

Notes:
Type of insulation housing: ELR W 3...2, ELR W 3...9 Polyamide PA non-reinforced, color: green
ELR W 3...16, ELR W 3...37 Polyester PBT non-reinforced, color: green
Marking systems and mounting material See Catalog 5



For reversing 3~ AC motors up to 575 V AC/3 x 2 A

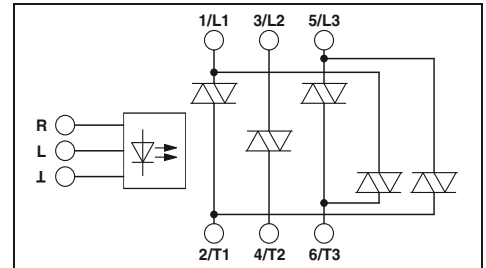

Technical data

Input data	
Rated actuating voltage U_c R/L	24 V DC / 230 V AC
Rated actuating voltage range with reference to U_c	0.8 ... 1.25 / 0.4 ... 1.1
Rated actuating current I_c at U_c	12.7 mA / 11.2 mA
Input circuit	Protection against polarity reversal, Surge protection
Operating voltage / status / error indicator	- / Yellow LED / Red LED
Output data load side	
Output voltage range	48 V AC ... 575 V AC / 48 V AC ... 575 V AC
Periodic peak reverse voltage	1200 V / 1200 V
Load current	max. 2 A / max. 2 A (see derating curve) / (see derating curve)
Surge current	200 A (t = 10 ms) / 200 A (t = 10 ms)
Minimum load current	100 mA / 100 mA
Residual voltage	< 1.5 V / < 1.5 V
Leakage current	6 mA / 6 mA
Maximum load value $I^2 \times t$ (t = 10 ms)	250 A ² s / 250 A ² s
Output protection	RCV circuit
General data	
Rated insulation voltage	500 V
Rated surge voltage	6 kV/basic isolation / 6 kV/basic isolation
Reversing frequency	max. 10 Hz / max. 2 Hz
Switching frequency	max. 5 Hz / max. 1 Hz
Ambient temperature (operation)	-25°C ... 70°C
Standards/regulations	DIN EN 50178 / EN 60947
Power station requirements	DWR 1300 / ZXX01/DD/7080.8d
Degree of protection according to IEC 60529/ EN 60529	IP20
Mounting position	Vertical (horizontal DIN rail)
Mounting	Can be aligned with spacing = 20 mm
Screw connection solid / stranded / AWG	0.14 - 2.5 mm ² / 0.14 - 2.5 mm ² / 26 - 12
- Control side	0.14 - 2.5 mm ² / 0.14 - 2.5 mm ² / 26 - 12
- Load side	40 mm / 99 mm / 114.5 mm
Dimensions	W / H / D

24 V DC	230 V AC
0.8 ... 1.25	0.4 ... 1.1
12.7 mA	11.2 mA
Protection against polarity reversal, Surge protection	Surge protection
	- / Yellow LED / Red LED
48 V AC ... 575 V AC	48 V AC ... 575 V AC
1200 V	1200 V
max. 2 A	max. 2 A
(see derating curve)	(see derating curve)
200 A (t = 10 ms)	200 A (t = 10 ms)
100 mA	100 mA
< 1.5 V	< 1.5 V
6 mA	6 mA
250 A ² s	250 A ² s
	RCV circuit
500 V	
6 kV/basic isolation	6 kV/basic isolation
max. 10 Hz	max. 2 Hz
max. 5 Hz	max. 1 Hz
-25°C ... 70°C	
DIN EN 50178 / EN 60947	
DWR 1300 / ZXX01/DD/7080.8d	
IP20	
Vertical (horizontal DIN rail)	
Can be aligned with spacing = 20 mm	
0.14 - 2.5 mm ² / 0.14 - 2.5 mm ² / 26 - 12	
0.14 - 2.5 mm ² / 0.14 - 2.5 mm ² / 26 - 12	
40 mm / 99 mm / 114.5 mm	



Load current as a function of the ambient temperature
Operating time: 100% operating factor

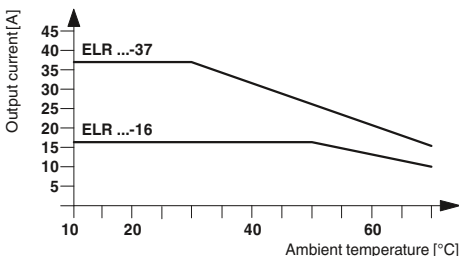

Load current as a function of the ambient temperature
Operating time: 100% operating factor

Description	3-phase solid-state reversing contactor
Thermal fuse	

Ordering data		
Type	Order No.	Pcs. / Pkt.
ELR W3- 24DC/500AC- 2	2297293	1
ELR W3-230AC/500AC- 2	2297303	1
Accessories		
THERMAL FUSE TF104	2900796	1



For reversing 3~ AC motors up to 575 V AC/3 x 9 A



For reversing 3~ AC motors up to 575 V AC/3 x 16 A

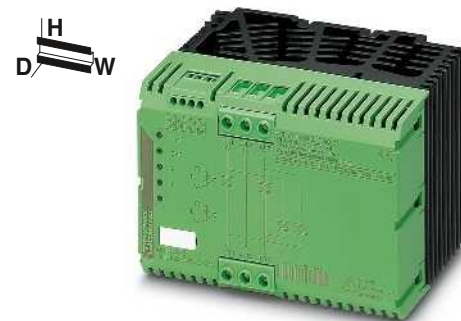

For reversing 3~ AC motors up to 575 V AC/3 x 37 A



Technical data

Technical data

Technical data

24 V DC 0.8 ... 1.25	230 V AC 0.4 ... 1.1
12.7 mA	11.2 mA
Protection against polarity reversal, Surge protection	Surge protection
- / Yellow LED / Red LED	

24 V DC 0.8 ... 1.25	230 V AC 0.4 ... 1.1
12.7 mA	11.2 mA
Protection against polarity reversal, Surge protection	Surge protection
- / Yellow LED / Red LED	

24 V DC 0.8 ... 1.25	230 V AC 0.4 ... 1.1
12.7 mA	11.2 mA
Protection against polarity reversal, Surge protection	Surge protection
- / Yellow LED / Red LED	

48 V AC ... 575 V AC 1200 V max. 9 A (see derating curve)	48 V AC ... 575 V AC 1200 V max. 9 A (see derating curve)
300 A (t = 10 ms) 100 mA < 1.5 V 6 mA 580 A ² s	300 A (t = 10 ms) 100 mA < 1.5 V 6 mA 580 A ² s
RCV circuit	

48 V AC ... 575 V AC 1200 V max. 16 A (see derating curve)	48 V AC ... 575 V AC 1200 V max. 16 A (see derating curve)
300 A (t = 10 ms) 100 mA < 1.5 V 6 mA 580 A ² s	300 A (t = 10 ms) 100 mA < 1.5 V 6 mA 580 A ² s
RCV circuit	

48 V AC ... 575 V AC 1200 V max. 37 A (see derating curve)	48 V AC ... 575 V AC 1200 V max. 37 A (see derating curve)
1300 A (t = 10 ms) 200 mA < 1.5 V 6 mA 9000 A ² s	1300 A (t = 10 ms) 200 mA < 1.5 V 6 mA 9000 A ² s
RCV circuit	

500 V 6 kV/basic isolation max. 10 Hz max. 5 Hz -25°C ... 70°C DIN EN 50178 / EN 60947 DWR 1300 / ZXX01/DD/7080.8d IP20 Vertical (horizontal DIN rail) Can be aligned with spacing = 20 mm	500 V 6 kV/basic isolation max. 2 Hz max. 1 Hz -25°C ... 70°C DIN EN 50178 / EN 60947 DWR 1300 / ZXX01/DD/7080.8d IP20 Vertical (horizontal DIN rail) Can be aligned with spacing = 40 mm
0.14 - 2.5 mm ² / 0.14 - 2.5 mm ² / 26 - 12 0.14 - 2.5 mm ² / 0.14 - 2.5 mm ² / 26 - 12 67.5 mm / 99 mm / 114.5 mm	0.2 - 4 mm ² / 0.2 - 2.5 mm ² / 24 - 12 0.5 - 16 mm ² / 0.5 - 16 mm ² / 20 - 6 147.5 mm / 99 mm / 114.5 mm

500 V 6 kV/basic isolation max. 10 Hz max. 5 Hz -25°C ... 70°C DIN EN 50178 / EN 60947 DWR 1300 / ZXX01/DD/7080.8d IP20 Vertical (horizontal DIN rail) Can be aligned with spacing = 40 mm	500 V 6 kV/basic isolation max. 2 Hz max. 1 Hz -25°C ... 70°C DIN EN 50178 / EN 60947 DWR 1300 / ZXX01/DD/7080.8d IP20 Vertical (horizontal DIN rail) Can be aligned with spacing = 40 mm
0.2 - 4 mm ² / 0.2 - 2.5 mm ² / 24 - 12 0.5 - 16 mm ² / 0.5 - 16 mm ² / 20 - 6 147.5 mm / 99 mm / 114.5 mm	0.2 - 4 mm ² / 0.2 - 2.5 mm ² / 24 - 12 0.5 - 16 mm ² / 0.5 - 16 mm ² / 20 - 6 147.5 mm / 99 mm / 114.5 mm

500 V 6 kV/basic isolation max. 10 Hz max. 5 Hz -25°C ... 70°C DIN EN 50178 / EN 60947 DWR 1300 / ZXX01/DD/7080.8d IP20 Vertical (horizontal DIN rail) Can be aligned with spacing = 40 mm	500 V 6 kV/basic isolation max. 2 Hz max. 1 Hz -25°C ... 70°C DIN EN 50178 / EN 60947 DWR 1300 / ZXX01/DD/7080.8d IP20 Vertical (horizontal DIN rail) Can be aligned with spacing = 40 mm
0.2 - 4 mm ² / 0.2 - 2.5 mm ² / 24 - 12 0.5 - 16 mm ² / 0.5 - 16 mm ² / 20 - 6 147.5 mm / 99 mm / 114.5 mm	0.2 - 4 mm ² / 0.2 - 2.5 mm ² / 24 - 12 0.5 - 16 mm ² / 0.5 - 16 mm ² / 20 - 6 147.5 mm / 99 mm / 114.5 mm

Ordering data

Ordering data

Ordering data

Type	Order No.	Pcs. / Pkt.
ELR W3- 24DC/500AC- 9	2297316	1
ELR W3-230AC/500AC- 9	2297329	1

Type	Order No.	Pcs. / Pkt.
ELR W3- 24DC/500AC-16	2297332	1
ELR W3-230AC/500AC-16	2297345	1

Type	Order No.	Pcs. / Pkt.
ELR W2+1- 24DC/500AC-37	2297374	1
ELR W2+1-230AC/500AC-37	2297387	1

Accessories

Accessories

Accessories

THERMAL FUSE TF104	2900796	1
--------------------	---------	---

THERMAL FUSE TF104	2900796	1
--------------------	---------	---

THERMAL FUSE TF104	2900796	1
--------------------	---------	---

Solid-state contactors

Three-phase semiconductor contactor

Motors of mixers, machine tools, conveying systems, pumps, and fans up to 575 V AC/3 x 37 A (equivalent to 1 kW to 18.5 kW) can be controlled using the CONTACTRON three-phase semiconductor contactors.

Advantages of three-phase semiconductor contactors:

- Noise-free and wear-free switching
- Integrated protective circuit
- Stable and short switching times
- Long service life
- High switching frequency
- Thermal fuse optional

Notes:
Type of insulation housing: ELR 3...2, ELR 3...9 Polyamide PA non-reinforced, color: green
ELR 3...16, ELR 3...37 Polyester PBT non-reinforced, color: green
Marking systems and mounting material See Catalog 5



For switching 3~ AC motors up to 575 V AC/3 x 2 A

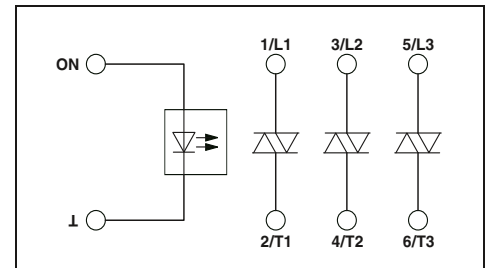

Technical data

Input data	24 V DC	230 V AC
Rated actuating voltage U_C ON	0.8 ... 1.25	0.4 ... 1.1
Rated actuating voltage range with reference to U_C		
Rated actuating current I_C at U_C	8.3 mA	12.5 mA
Input circuit	Protection against polarity reversal, Surge protection	Surge protection
Operating voltage / status / error indicator	- / Yellow LED / Red LED	
Output data load side		
Output voltage range	48 V AC ... 575 V AC	48 V AC ... 575 V AC
Periodic peak reverse voltage	1200 V	1200 V
Load current	max. 2 A (see derating curve)	max. 2 A (see derating curve)
Surge current	200 A (t = 10 ms)	200 A (t = 10 ms)
Minimum load current	100 mA	100 mA
Residual voltage	< 1.5 V	< 1.5 V
Leakage current	6 mA	6 mA
Maximum load value $I^2 \times t$ (t = 10 ms)	250 A ² s	250 A ² s
Output protection	RCV circuit	
General data		
Rated insulation voltage	500 V	
Rated surge voltage	6 kV/basic isolation	6 kV/basic isolation
Switching frequency	max. 10 Hz	max. 1 Hz
Ambient temperature (operation)	-25°C ... 70°C	
Standards/regulations	DIN EN 50178 / EN 60947	
Power station requirements	DWR 1300 / ZXX01/DD/7080.8d	
Degree of protection according to IEC 60529/ EN 60529	IP20	
Mounting position	Vertical (horizontal DIN rail)	
Mounting	Can be aligned with spacing = 20 mm	
Screw connection solid / stranded / AWG	0.14 - 2.5 mm ² / 0.14 - 2.5 mm ² / 26 - 12	
- Control side	0.14 - 2.5 mm ² / 0.14 - 2.5 mm ² / 26 - 12	
- Load side	40 mm / 99 mm / 114.5 mm	
Dimensions	W / H / D	

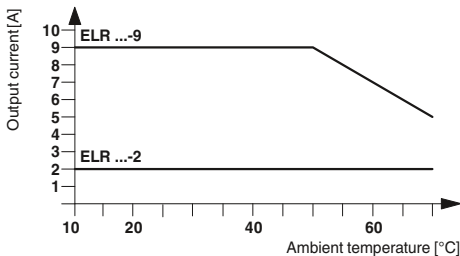

Load current as a function of the ambient temperature
Operating time: 100% operating factor

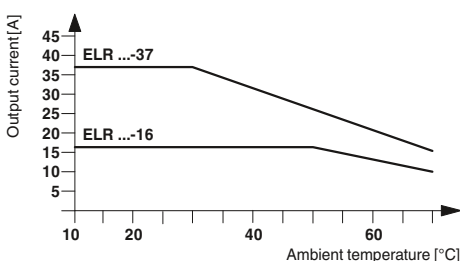

Load current as a function of the ambient temperature
Operating time: 100% operating factor

Description
Three-phase semiconductor contactor

Thermal fuse
THERMAL FUSE TF104

Ordering data		
Type	Order No.	Pcs. / Pkt.
ELR 3- 24DC/500AC- 2	2297196	1
ELR 3-230AC/500AC- 2	2297206	1

Accessories		
THERMAL FUSE TF104	2900796	1



For switching 3~ AC motors up to 575 V AC/3 x 9 A



For switching 3~ AC motors up to 575 V AC/3 x 16 A



For switching 3~ AC motors up to 575 V AC/3 x 37 A



Technical data

24 V DC 0.8 ... 1.25	230 V AC 0.4 ... 1.1
8.3 mA	12.5 mA
Protection against polarity reversal, Surge protection	Surge protection
- / Yellow LED / Red LED	

48 V AC ... 575 V AC 1200 V max. 9 A (see derating curve)	48 V AC ... 575 V AC 1200 V max. 9 A (see derating curve)
--	--

300 A (t = 10 ms) 100 mA < 1.5 V 6 mA 580 A ² s	300 A (t = 10 ms) 100 mA < 1.5 V 6 mA 580 A ² s
RCV circuit	

500 V 6 kV/basic isolation max. 10 Hz -25°C ... 70°C DIN EN 50178 / EN 60947 DWR 1300 / ZXX01/DD/7080.8d IP20 Vertical (horizontal DIN rail) Can be aligned with spacing = 20 mm	6 kV/basic isolation max. 1 Hz
--	-----------------------------------

0.14 - 2.5 mm ² / 0.14 - 2.5 mm ² / 26 - 12 0.14 - 2.5 mm ² / 0.14 - 2.5 mm ² / 26 - 12 67.5 mm / 99 mm / 114.5 mm
--

Ordering data

Type	Order No.	Pcs. / Pkt.
ELR 3-24DC/500AC-9	2297219	1
ELR 3-230AC/500AC-9	2297222	1

Accessories

THERMAL FUSE TF104	2900796	1
--------------------	---------	---

Technical data

24 V DC 0.8 ... 1.25	230 V AC 0.4 ... 1.1
8.3 mA	12.5 mA
Protection against polarity reversal, Surge protection	Surge protection
- / Yellow LED / Red LED	

48 V AC ... 575 V AC 1200 V max. 16 A (see derating curve)	48 V AC ... 575 V AC 1200 V max. 16 A (see derating curve)
---	---

300 A (t = 10 ms) 100 mA < 1.5 V 6 mA 580 A ² s	300 A (t = 10 ms) 100 mA < 1.5 V 6 mA 580 A ² s
RCV circuit	

500 V 6 kV/basic isolation max. 10 Hz -25°C ... 70°C DIN EN 50178 / EN 60947 DWR 1300 / ZXX01/DD/7080.8d IP20 Vertical (horizontal DIN rail) Can be aligned with spacing = 40 mm	6 kV/basic isolation max. 1 Hz
--	-----------------------------------

0.2 - 4 mm ² / 0.2 - 2.5 mm ² / 24 - 12 0.5 - 16 mm ² / 0.5 - 16 mm ² / 20 - 6 147.5 mm / 99 mm / 114.5 mm
--

Ordering data

Type	Order No.	Pcs. / Pkt.
ELR 3-24DC/500AC-16	2297235	1
ELR 3-230AC/500AC-16	2297248	1

Accessories

THERMAL FUSE TF104	2900796	1
--------------------	---------	---

Technical data

24 V DC 0.8 ... 1.25	230 V AC 0.4 ... 1.1
8.3 mA	12.5 mA
Protection against polarity reversal, Surge protection	Surge protection
- / Yellow LED / Red LED	

48 V AC ... 575 V AC 1200 V max. 37 A (see derating curve)	48 V AC ... 575 V AC 1200 V max. 37 A (see derating curve)
---	---

1300 A (t = 10 ms) 200 mA < 1.5 V 6 mA 9000 A ² s	1300 A (t = 10 ms) 200 mA < 1.5 V 6 mA 9000 A ² s
RCV circuit	

500 V 6 kV/basic isolation max. 10 Hz -25°C ... 70°C DIN EN 50178 / EN 60947 DWR 1300 / ZXX01/DD/7080.8d IP20 Vertical (horizontal DIN rail) Can be aligned with spacing = 40 mm	6 kV/basic isolation max. 1 Hz
--	-----------------------------------

0.2 - 4 mm ² / 0.2 - 2.5 mm ² / 24 - 12 0.5 - 16 mm ² / 0.5 - 16 mm ² / 20 - 6 147.5 mm / 99 mm / 114.5 mm
--

Ordering data

Type	Order No.	Pcs. / Pkt.
ELR 2+1-24DC/500AC-37	2297277	1
ELR 2+1-230AC/500AC-37	2297280	1

Accessories

THERMAL FUSE TF104	2900796	1
--------------------	---------	---

Solid-state contactors

Electronic reversing load relay, with integrated soft switch

The ELR W 3/9-400 S soft switch can be used to increase the service life of a 3-phase induction motor.

- Parameterization is performed directly on the device via display and keyboard
- Friction time
- Torque, start
- Start time
- Stop time
- Torque, stop
- Braking time
- Braking torque
- Drive can be controlled locally via keyboard

Notes:
Type of housing: Polycarbonate PC, color: green.
Marking systems and mounting material See Catalog 5
1) EMC: Class A product, see page 571

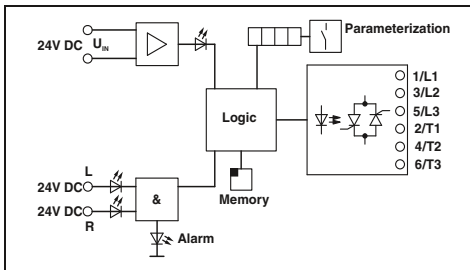

Input data
Supply nominal voltage U_{VN}
Supply voltage range with reference to U_{VN}
Quiescent current
Control voltage U_{ST} right/left
Control voltage range in reference to U_{ST}
Typ. input current at U_N
Input circuit
Operating voltage / status / error indicator
Output data load side
Maximum switching voltage
Output voltage range
Periodic peak reverse voltage
Load current
Surge current
Minimum load current
Residual voltage
Leakage current
Output protection
General data
Test voltage input/output
Ambient temperature (operation)
Standards/regulations
Power station requirements
EMC regulations
Degree of protection according to IEC 60529/ EN 60529
Mounting position
Mounting
Screw connection solid / stranded / AWG
Dimensions

Technical data
24 V DC
0.8 ... 1.2
85 mA
24 V DC
0.8 ... 1.2
5 mA
Protection against polarity reversal, Surge protection
Green LED / Yellow LED / Red LED
440 V AC (L1/T1)
440 V AC (L2/T2)
440 V AC (L3/T3)
110 V AC ... 433 V AC
1000 V
< 8 A (IL1, at 20°C Tu, see derating)
< 8 A (IL2, at 20°C Tu, see derating)
< 8 A (IL3, at 20°C Tu, see derating)
230 A (tp = 10 ms, at 25°C)
150 mA
Typ. 1.5 V (For IL)
5 mA (IL1, in switched-off state)
RC element, surge protection
2.5 kV
-20°C ... 60°C
DIN EN 50178 / Safe isolation
DWR 1300 / ZX01/DD/7080.8d
EN 61000-6-2 / EN 61000-6-4
IP20
Vertical (horizontal DIN rail)
Can be aligned with > 20 mm spacing
0.2 - 6 mm ² / 0.2 - 4 mm ² / 24 - 10
62 mm / 94 mm / 122 mm

Description
Electronic reversing load relay, with an integrated soft switch

Ordering data		
Type	Order No.	Pcs. / Pkt.
ELR W3/ 9-400 S ¹⁾	2963569	1

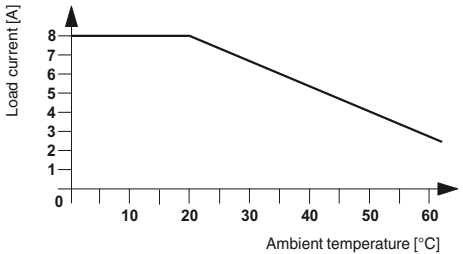

Load current as a function of the ambient temperature
Operating time: 100% operating factor

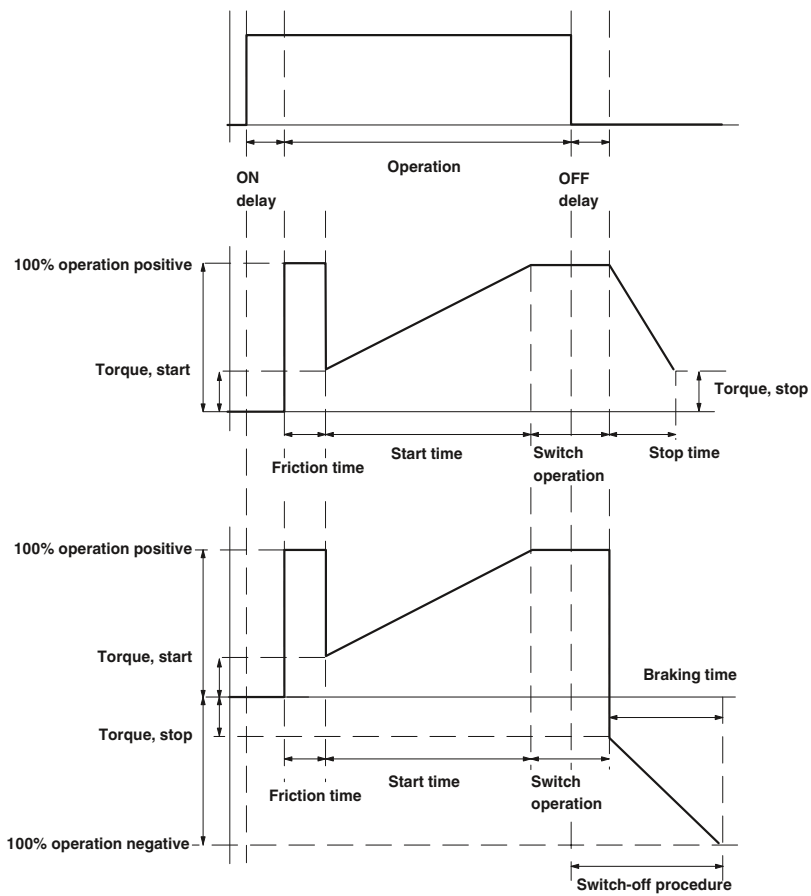

The figure shows the control of the reversing load relay with a soft starter and the operation of a three-phase current load.

Solid-state contactors

Electronic reversing load relay for DC motors

The ELR-DC electronic reversing load relay allows mechanically commutated DC motors to be switched. They reverse and reduce the speed of DC motors up to 24 V/6 A in a wear-free manner. A short-circuit, surge-voltage, and overload-proof output guarantees reliable use in the plant.

If a 24 V DC signal is applied to the “left” input, the ELR-DC is interconnected so that the output supplies the motor with voltage. If the “right” input is triggered, the polarity of the voltage is inverted on the output. By triggering both inputs, i.e., “right” and “left”, the motor is short-circuited internally via the ELR-DC and reduces the speed.

Thanks to the internal interlocking circuit and load wiring, wiring expense is reduced to a minimum.

Notes:
Type of housing: Polycarbonate PC, color: green.
Marking systems and mounting material See Catalog 5
PWM = Pulse Width Modulation
1) EMC: Class A product, see page 571



Application example



Status table

Input		Output	
Right	Left	M +	M -
0	0	High resistance	High resistance
1	0	+24 V	GND
0	1	GND	+24 V
1	1	GND	GND

Load current depending on ambient temperature

Operating time: 100% OT



- ① Single device
- ② Aligned without spacing

Input data	Control voltage U_{ST} right/left Control voltage range in reference to U_{ST} Typ. input current at U_N Input circuit Operating voltage / status / error indicator
PWM option	Maximum clock frequency of the PWM at the control inputs
	Pulse width repetition rate of the PWM
Output data load side	Output voltage range Load current
	Quiescent current
	Current limitation at short-circuits
	Output protection Operating voltage / status / error indicator
General data	Test voltage input/output Ambient temperature (operation) Nominal operating mode Standards/regulations Degree of protection according to IEC 60529/ EN 60529 Mounting position Screw connection solid / stranded / AWG Dimensions

Technical data	
24 V DC 0.8 ... 1.2 3 mA	24 V DC 0.8 ... 1.2 3 mA
Protection against polarity reversal, Surge protection Green LED / LED yellow, forward running (R), LED yellow, reverse running (L) / -	
1000 Hz	1000 Hz
0% ... 100%	0% ... 100%
10 V DC ... 30 V DC 2 A (Mounted in rows with zero spacing)	10 V DC ... 30 V DC 6 A (see derating curve)
Approx. 7 mA (When switched off) 15 A	Approx. 7 mA (When switched off) 20 A
Protection against polarity reversal, Surge protection Green LED / - / -	
2.5 kV AC -20°C ... 60°C 100% operating factor EN 50178 / Basic insulation IP20 Vertical (horizontal DIN rail) 0.2 - 6 mm ² / 0.2 - 4 mm ² / 24 - 10 12.5 mm / 99 mm / 114.5 mm	

Description	3-phase solid-state reversing contactor, for controlling DC motors
--------------------	---

Ordering data		
Type	Order No.	Pcs. / Pkt.
ELR W1/ 2-24DC ¹⁾	2963598	1
ELR W1/ 6-24DC ¹⁾	2982090	1

Solid-state contactors

Single-phase solid-state contactors

Single-phase solid-state contactors are used in AC voltage networks wherever silent switching, high switching frequencies, and a practically unlimited service life are required.

The sturdy power semi-conductors switch in zero voltage crossing and thus produce no additional high-frequency interferences. The modules are insensitive to shock loads and vibrations – even use in aggressive, polluted environments is unproblematic.

They offer the following advantages:

- High switching frequency
 - Wear-free and output-free
 - Input voltage versions 24 V DC and 230 V AC
- Common areas of application are:
- Production machines
 - Temperature controllers
 - Conveyor equipment
 - Light and lighting systems.

Notes:
Type of housing: Polycarbonate PC, color: green.
Marking systems and mounting material See Catalog 5



For switching 1~ AC motors up to 660 V AC/20 A

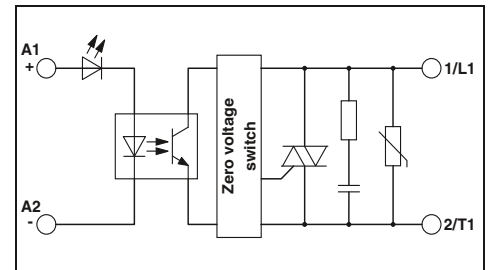

Technical data

Input data		4 V DC ... 32 V DC	24 V AC ... 275 V AC
Input voltage range		Approx. 12 mA	Approx. 17 mA
Typ. input current at U_N		≥ 4 V DC	≥ 22 V AC
Switching level	1 signal ("H") 0 signal ("L")	≤ 1 V DC	≤ 6 V AC
Transmission frequency f_{limit}		25 Hz	6 Hz
Operating voltage / status / error indicator			Green LED / - / -
Output data load side		42 V AC ... 660 V AC (45/65 Hz)	42 V AC ... 660 V AC (45/65 Hz)
Output voltage range		1200 V	1200 V
Periodic peak reverse voltage		20 A (see derating curve)	20 A (see derating curve)
Load current		250 A ($t = 10$ ms)	250 A ($t = 10$ ms)
Surge current		350 mA	350 mA
Minimum load current		< 1.6 V	< 1.6 V
Residual voltage		< 3 mA (In off state)	< 3 mA (In off state)
Leakage current		0.5	0.5
Phase angle ($\cos \phi$)		525 A ² s	525 A ² s
Maximum load value $I^2 \times t$ ($t = 10$ ms)			RVC circuit
Output protection			
General data		4 kV _{rms}	
Test voltage input/output		-30°C ... 70°C	
Ambient temperature (operation)		EN 61000-4-2 / EN 61000-4-3 / EN 61000-4-4 / EN 61000-4-5 / EN 61000-4-6 / EN 55011 / Basic insulation	
Standards/regulations		Vertical (horizontal DIN rail)	
Mounting position		Can be aligned with ≥ 22.5 mm spacing	
Mounting		0.5 - 2.5 mm ² / 0.5 - 2.5 mm ² / 20 - 14	
Screw connection solid / stranded / AWG		0.5 - 4 mm ² / 0.5 - 4 mm ² / 20 - 12	
- Control side		22.5 mm / 103 mm / 103 mm	
- Load side			
Dimensions	W / H / D		

Description
Single-phase electronic load relay

Ordering data

Type	Order No.	Pcs. / Pkt.
ELR 1- 24DC/600AC-20	2297138	1
ELR 1-230AC/600AC-20	2297141	1

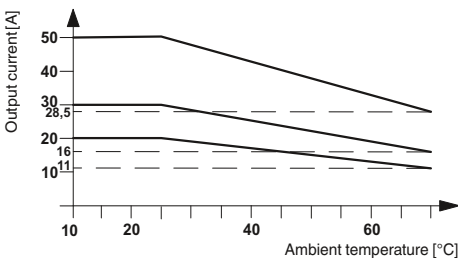

Load current as a function of the ambient temperature
Operating time: 100% operating factor



For switching 1~ AC motors up to 660 V AC/30 A



For switching 1~ AC motors up to 660 V AC/50 A



Technical data

4 V DC ... 32 V DC	24 V AC ... 275 V AC
Approx. 12 mA	Approx. 17 mA
≥ 4 V DC	≥ 22 V AC
≤ 1 V DC	≤ 6 V AC
25 Hz	6 Hz
Green LED / - / -	

42 V AC ... 660 V AC (45/65 Hz)	42 V AC ... 660 V AC (45/65 Hz)
1200 V	1200 V
30 A (see derating curve)	30 A (see derating curve)
400 A (t = 10 ms)	400 A (t = 10 ms)
150 mA	150 mA
< 1.6 V	< 1.6 V
< 3 mA (In off state)	< 3 mA (In off state)
0.5	0.5
1800 A ² s	1800 A ² s
RCV circuit	

4 kV_{rms}
 -30°C ... 70°C
 EN 61000-4-2 / EN 61000-4-3 / EN 61000-4-4 / EN 61000-4-5 / EN 61000-4-6 / EN 55011 / Basic insulation

Vertical (horizontal DIN rail)
 Can be aligned with ≥ 22.5 mm spacing

0.5 - 2.5 mm² / 0.5 - 2.5 mm² / 20 - 14
 0.5 - 4 mm² / 0.5 - 4 mm² / 20 - 12
 22.5 mm / 103 mm / 103 mm

Ordering data

Type	Order No.	Pcs. / Pkt.
ELR 1- 24DC/600AC-30	2297154	1
ELR 1-230AC/600AC-30	2297167	1



Technical data

4 V DC ... 32 V DC	24 V AC ... 275 V AC
Approx. 12 mA	Approx. 17 mA
≥ 4 V DC	≥ 22 V AC
≤ 1 V DC	≤ 6 V AC
25 Hz	6 Hz
Green LED / - / -	

42 V AC ... 660 V AC (45/65 Hz)	42 V AC ... 660 V AC (45/65 Hz)
1200 V	1200 V
50 A (see derating curve)	50 A (see derating curve)
1900 A (t = 10 ms)	1900 A (t = 10 ms)
150 mA	150 mA
< 1.6 V	< 1.6 V
< 3 mA (In off state)	< 3 mA (In off state)
0.5	0.5
18,000 A ² s	18,000 A ² s
RCV circuit	

4 kV_{rms}
 -30°C ... 70°C
 EN 61000-4-2 / EN 61000-4-3 / EN 61000-4-4 / EN 61000-4-5 / EN 61000-4-6 / EN 55011 / Basic insulation

Vertical (horizontal DIN rail)
 Can be aligned with ≥ 22.5 mm spacing

0.5 - 4 mm² / 0.5 - 4 mm² / 20 - 12
 4 - 25 mm² / 4 - 25 mm² / 12 - 3
 45 mm / 103 mm / 103 mm

Ordering data

Type	Order No.	Pcs. / Pkt.
ELR 1- 24DC/600AC-50	2297170	1
ELR 1-230AC/600AC-50	2297183	1

IP67 motor starters

PROFINET motor starter

Motor starters in robust stainless steel housing (IP67) can be used directly in the system as a compact function unit. This eliminates the complex wiring of individual functions in the control cabinet.

The motor starter can be used to control three-phase asynchronous motors in two directions of rotation, completely via PROFINET. Distributed sensors and actuators can be directly connected to PROFINET without the need for further intermediate stations or additional cabling.

A complete PROFINET motor starter consists of three products. For example:

- ELR 5011 IP PN
- IBS IP 400 MBH-F
- IBS PG SET

Additional features:

- Performance classes: 0.06 kW to 3.0 kW
- Simple assembly
- Plug-in connection system
- Exchangeable module electronics
- Status and diagnostic indicators on the module
- 10 digital inputs for connecting sensors
- 4 digital outputs for connecting actuators
- One- and two-motor reversing starters

Notes:

1) EMC: Class A product, see page 571



**Electronic motor starters,
1 x 1.1 kW and 2 x 1.1 kW**

PROFIBUS

Interface	
Fieldbus system	PROFINET
Connection method	8-pos. RJ45 socket on motor starter
Power supply for module electronics	
Supply voltage	24 V DC (U_{S1} / U_{S2})
Supply voltage range	20 V DC ... 30 V DC (including ripple)
Power supply for sensors	
Minimum voltage	$U_{MI} = U_{S1}$ minus 1 V
Nominal current per sensor	500 mA
Type of protection	Short-circuit/overload protection
Digital inputs	
Number of inputs	10
Connection method	M12 plug-in connector
Connection method	2, 3, 4-conductor
Digital outputs	
Number of outputs	4
Connection method	M12 plug-in connector
Connection method	2-conductor
Output current	max. 500 mA (per channel)
Motor starter, output	
Connection method	POWER-COMBICON
Operating voltage	360 V AC ... 550 V AC (line voltage 50/60 Hz)
Nominal current range	0.18 A ... 2.4 A
Frequency range	50 Hz ... 60 Hz (mains frequency)
Nominal motor power	1.1 kW (at $U_{mains} = 400$ V AC)
Motor monitoring	
Parameterization range	0.2 A ... 2.4 A
Tripping class	Based on class 10 A of IEC 60947
General data	
Weight	2115 g 2425 g
Degree of protection	IP67 according to IEC 60529
Ambient temperature (operation)	-25°C ... 50°C (no condensation)

Technical data	
ELR 5011 IP PN	ELR 5011-2 IP PN
PROFINET	
8-pos. RJ45 socket on motor starter	
24 V DC (U_{S1} / U_{S2})	
20 V DC ... 30 V DC (including ripple)	
$U_{MI} = U_{S1}$ minus 1 V	
500 mA	
Short-circuit/overload protection	
10	
M12 plug-in connector	
2, 3, 4-conductor	
4	
M12 plug-in connector	
2-conductor	
max. 500 mA (per channel)	
POWER-COMBICON	
360 V AC ... 550 V AC (line voltage 50/60 Hz)	
0.18 A ... 2.4 A	
50 Hz ... 60 Hz (mains frequency)	
1.1 kW (at $U_{mains} = 400$ V AC)	
0.2 A ... 2.4 A	
Based on class 10 A of IEC 60947	
2115 g	2425 g
IP67 according to IEC 60529	
-25°C ... 50°C (no condensation)	

Description	
PROFINET motor starter	
- 1-channel reversing starter, 1.1 kW	
- 2-channel reversing starter, 1.1 kW	
PROFINET motor starter	
- 1-channel reversing starter, 3.0 kW	
- 2-channel reversing starter, 3.0 kW	
Lower part of the housing, stainless steel	
- Standard version	
Pg screw connection, plastic (IP67), for INTERBUS and PROFINET motor starters and variable frequency drives.	

Ordering data		
Type	Order No.	Pcs. / Pkt.
ELR 5011 IP PN	2700745	1
ELR 5011-2 IP PN	2701007	1
IBS IP 400 MBH -F ¹⁾	2732868	1
IBS PG SET	2836599	1

RJ45 connector, shielded, with bend protection sleeve, x 2	
- gray for straight cables	
- green for crossed cables	
Bus system cable	
Crimping pliers, for assembling the RJ45 connectors	

Accessories		
Type	Order No.	Pcs. / Pkt.
FL PLUG RJ45 GR/2	2744856	1
FL PLUG RJ45 GN/2	2744571	1
VS-937/...	1402611	1
FL CRIMPTOOL	2744869	1

N

PROFINET



Electronic motor starters, 1 x 3.0 kW and 2 x 3.0 kW



High-grade steel lower part, IP67 degree of protection



Technical data	
ELR 5030 IP PN	ELR 5030-2 IP PN
PROFINET	
8-pos. RJ45 socket on motor starter	
24 V DC (U_{S1} / U_{S2})	
20 V DC ... 30 V DC (including ripple)	
$U_{IN} = U_{S1}$ minus 1 V	
500 mA	
Short-circuit/overload protection	
10	
M12 plug-in connector	
2, 3, 4-conductor	
4	
M12 plug-in connector	
2-conductor	
max. 500 mA (per channel)	
POWER-COMBICON	
360 V AC ... 550 V AC (line voltage 50/60 Hz)	
2.4 A ... 6 A	
50 Hz ... 60 Hz (mains frequency)	
3 kW (at $U_{mains} = 400$ V AC)	
2.4 A ... 6 A	
Based on class 10 A of IEC 60947	
2115 g	2425 g
IP67 according to IEC 60529	
-25°C ... 50°C (no condensation)	

Technical data	
IBS IP 400 MBH -F1)	
-	-
-	-
-	-
-	-
-	-
-	-
-	-
-	-
-	-
-	-
-	-
-	-
-	-
-	-
-	-
-	-
-	-
-	-
1130 g	-
IP67 according to IEC 60529	
-	-

Ordering data		
Type	Order No.	Pcs. / Pkt.
ELR 5030 IP PN	2701006	1
ELR 5030-2 IP PN	2701008	1
IBS IP 400 MBH -F1)	2732868	1
IBS PG SET	2836599	1

Ordering data		
Type	Order No.	Pcs. / Pkt.
IBS IP 400 MBH -F1)	2732868	1
IBS PG SET	2836599	1

Accessories		
Type	Order No.	Pcs. / Pkt.
FL PLUG RJ45 GR/2	2744856	1
FL PLUG RJ45 GN/2	2744571	1
VS-937/...	1402611	1
FL CRIMPTOOL	2744869	1

Accessories		
Type	Order No.	Pcs. / Pkt.
FL PLUG RJ45 GR/2	2744856	1
FL PLUG RJ45 GN/2	2744571	1
VS-937/...	1402611	1
FL CRIMPTOOL	2744869	1

Inline frequency inverters for the control cabinet are the compact solution for extending your Easy Automation solution to include electronic speed regulation for asynchronous motors. The devices seamlessly integrate into the Inline system and have IP20 protection. Depending on the drive task, you can select frequency inverters from various performance classes, up to a maximum of 4 kW. In order to connect to the Inline system via the Fieldline local bus, you just need the IB IL 24 FLM-PAC Inline module. The Inline frequency inverter can be connected to a Phoenix Contact controller via the Inline module.

Additional features:

- Maximum motor power
0.75 kW, 1.5 kW, 2.2 kW, and 4.0 kW
- 3 x 400 V mains input (±15%) 50/60 Hz
- DTM for parameterization and diagnostics
- 8 freely programmable parameter records
- PTC evaluation for
2.2 kW and 4.0 kW versions
- Integrated line filter
- U/f linear and U/f square operating modes
- S-ramp function
- Motor protection function (I²t)
- Connection of a braking resistor
- DC braking
- Evaluation of the temperature switch in the motor
- Voltage boost
- 1 x analog input, 1 x analog output,
1 x relay output

Notes:

1) EMC: Class A product, see page 571



0.75 kW

N

Technical data			
Interface			
Name	Fieldline local bus		
Connection method	9-pos. D-SUB plug/socket		
Power supply for module electronics			
Supply voltage	24 V DC ±15%		
Supply voltage range	20.4 V DC ... 27.6 V DC ±15%		
Digital inputs			
Number of inputs	5		
Connection method	COMBICON		
Connection method	Spring-cage connection		
Digital outputs			
Number of outputs	1		
Connection method	COMBICON		
Connection method	Spring-cage connection		
Motor starter, output			
Connection method	PCB terminal block		
Nominal current range	2.6 A (Short-term peak current, 1.5 times the nominal current for 30 s; permissible continuous current, 1.2 times the nominal current range)		
Frequency range	0 Hz ... 400 Hz		
Nominal motor power	0.75 kW		
Tripping class	5.6 A OC tripping current		
General data			
Weight	1400 g		
Degree of protection	IP20		
Width	86.8 mm		
Height	184 mm		
Depth	132.9 mm		
Ordering data			
Description	Type	Order No.	Pcs. / Pkt.
Inline frequency inverters for the control cabinet	VFD 5007 IL IB	2701054	1
Accessories			
Inline Modular branch terminal for coupling one Fieldline Modular M8 local bus at the end of an Inline station	IB IL 24 FLM-PAC ¹⁾	2736903	1
Remote bus cable, highly stranded, 3 x 2 x 0.25 mm ²	IBS RBC/F-T/	2740151	1

N



Frequency inverter for a max. motor power of up to 1.5 kW

N



Frequency inverter for a max. motor power of up to 2.2 kW

N



Frequency inverter for a max. motor power of up to 4.0 kW

Technical data
Fieldline local bus 9-pos. D-SUB plug/socket
24 V DC $\pm 15\%$ 20.4 V DC ... 27.6 V DC $\pm 15\%$
5 COMBICON Spring-cage connection
1 COMBICON Spring-cage connection
PCB terminal block 4.1 A (Short-term peak current, 1.5 times the nominal current for 30 s; permissible continuous current, 1.2 times the nominal current range)
0 Hz ... 400 Hz 1.5 kW 8.8 A OC tripping current
1400 g IP20 86.8 mm 184 mm 132.9 mm

Technical data
Fieldline local bus 9-pos. D-SUB plug/socket
24 V DC $\pm 15\%$ 20.4 V DC ... 27.6 V DC $\pm 15\%$
5 COMBICON Spring-cage connection
1 COMBICON Spring-cage connection
PCB terminal block 5.8 A (Short-term peak current, 1.5 times the nominal current for 30 s; permissible continuous current, 1.2 times the nominal current range)
0 Hz ... 400 Hz 2.2 kW 12.5 A OC tripping current
2006 g IP20 114 mm 184 mm 153 mm

Technical data
Fieldline local bus 9-pos. D-SUB plug/socket
24 V DC $\pm 15\%$ 20.4 V DC ... 27.6 V DC $\pm 15\%$
5 COMBICON Spring-cage connection
1 COMBICON Spring-cage connection
PCB terminal block 9.1 A (Short-term peak current, 1.5 times the nominal current for 30 s; permissible continuous current, 1.2 times the nominal current range)
0 Hz ... 400 Hz 4 kW 21 A OC tripping current
2006 g IP20 114 mm 184 mm 153 mm

Ordering data		
Type	Order No.	Pcs. / Pkt.
VFD 5015 IL IB	2701055	1

Ordering data		
Type	Order No.	Pcs. / Pkt.
VFD 5022 IL IB	2701057	1

Ordering data		
Type	Order No.	Pcs. / Pkt.
VFD 5040 IL IB	2701058	1

Accessories		
Type	Order No.	Pcs. / Pkt.
IB IL 24 FLM-PAC ¹⁾	2736903	1
IBS RBC/F-T/	2740151	1

Accessories		
Type	Order No.	Pcs. / Pkt.
IB IL 24 FLM-PAC ¹⁾	2736903	1
IBS RBC/F-T/	2740151	1

Accessories		
Type	Order No.	Pcs. / Pkt.
IB IL 24 FLM-PAC ¹⁾	2736903	1
IBS RBC/F-T/	2740151	1



Measurement and control technology

The modular analog converters for measurement and control technology prevent analog signals from being distorted by disturbance variables. With accurate conversion, isolation, filtering or amplification of analog signals, they secure and increase transmission quality and therefore the quality of closed-loop control circuits.

We offer the following product ranges:

Highly compact isolating amplifiers – MINI Analog

- For significant space savings and efficiency
- Design width of just 6.2 mm
- System cabling and multiplexer solutions
- 3-way electrical isolation

Isolating amplifiers with SIL functional safety – MACX Analog

- For maximum signal safety
- Consistent SIL certification
- Safe 3-way electrical isolation

Isolating amplifiers, special types, and digital displays – MCR Analog

- For special applications in signal processing
- Electrical isolation
- Record and convert temperatures directly in the field

Ex i isolating amplifiers with SIL functional safety – MACX Analog Ex

- For intrinsically safe circuits in the Ex area
- Maximum explosion protection for all Ex zones and gas groups
- Design width of just 12.5 mm for all single- and two-channel devices
- Safe 3-way electrical isolation

Product range overview

Product overview	54
Selection guide for isolating amplifiers	56
Basics	58
Highly compact isolating amplifiers – MINI Analog	64
Analog IN/Analog OUT	66
Temperature	76
Frequency	82
Potentiometers	84
Limit values	85
Digital IN	86
Accessories	87
Isolating amplifiers with SIL functional safety – MACX Analog	100
Analog IN/Analog OUT	102
Temperature potentiometers/limit values	110
Digital IN	120
Accessories	126
Isolating amplifiers, special designs, and digital displays – MCR Analog	130
Analog IN/Analog OUT	131
Temperature potentiometers/limit values	136
Frequency	144
Limit values	146
Accessories	149
Digital displays	150
EX i isolating amplifiers with SIL functional safety – MACX Analog Ex	152
Analog IN	160
Analog OUT	164
Temperature	165
Digital IN	172
Digital OUT	179
Accessories	182
Multiplexers for HART signals	186
Ex i 2-conductor field devices	187
Accessories	190

Highly compact isolating amplifiers



MINI Analog

Page 64



Supply components, feed-through terminal blocks, marking material

Page 88



System cabling, termination carriers

Page 92



Surge protection

Page 98

Digital displays



For standard signals, setpoint adjusters

Page 150

Ex i isolating amplifiers with functional safety



MACX Analog Ex

Page 152



Supply components, marking material

Page 182



System cabling, termination carriers

Page 184

Energy and power measuring technology



EMpro energy meters

Page 200



EMpro special function and communication modules

Page 202



PSK data logger kits

Page 206



PSK compressed air meters

Page 208



Current protectors, AC

Page 235



Voltage transducers

Page 236



SOLARCHECK PV string monitoring

Page 134



EMD-BL compact monitoring relays

Page 250

Isolating amplifiers with functional safety



MACX Analog Page 100



Supply components, marking material Page 126



System cabling, termination carriers Page 128

**Isolating amplifiers
Special designs**



MCR Analog Page 130

Multiplexers



Multiplexers for HART signals Page 186

Ex i 2-cond. field devices



Ex i 2-conductor field devices Page 187

Accessories



Shield fast connection Page 191



Test plugs Page 191

Current transformers



PACT current transformers Page 212

Test disconnect terminal blocks



Test disconnect terminal blocks See Catalog 3

Current and voltage measuring technology



Current transducers, AC/DC Page 229



Current transducers, AC Page 232



EMD multifunctional monitoring relays Page 252

Controllers



Controllers See Catalog 8

Surge protection



Surge protection for measurement and control technology See Catalog 6



Highly compact isolating amplifiers -
MINI Analog

		Page
Analog IN/Analog OUT		
3-way isolating amplifiers	Configurable	From 66
	Fixed signal combinations	71
4-way signal duplicators	Configurable	72
3-way repeater power supplies	1-channel	73
	Signal duplicators	
	2-channel	
2-way passive isolators	Supplied by an input loop	74
	Supplied by an output loop	75
3-way output isolators	Fixed signal combinations	
Digital displays	Standard signals	
	Setpoint adjuster	
Temperature		
Temperature transducers		
	Universal	
	Universal, supplied by an output loop	
	For resistance thermometers (RTD)	76
	For resistance thermometers (RTD), passive	
	For Pt 100	From 77
	For Pt 100, supplied by an output loop	79
	For thermocouples	80
	For thermocouples, type J and K	81
Temperature head transmitters	Universal, supplied by an output loop	
	Pt 100, supplied by an output loop	
Frequency		
Frequency transducers		
	Universal	82
Analog frequency transducers		
		83
Potentiometer/resistor		
Potipotentiometers		
		84
Setpoint potentiometers		
Limit values		
Threshold value switches		
	Standard analog signals, universal	
	Standard analog signals	85
	Temperature	
Digital IN		
Isolation amplifiers		
	NAMUR sensors, floating contacts	86
	NAMUR sensors, floating contacts, 2-channel	
	NAMUR sensors, floating contacts, wide range	
	NAMUR sensors on NAM	
Digital OUT		
Solenoid drivers		
	Loop-powered	
	With line fault detection	
Accessories		
Configuration		
	Configuration software	
	Cables	119
	Display unit and operator interface, removable	
	Holder module for display unit and operator interface	
Constant voltage source	Constant voltage source	87
Setpoint potentiometers		
System cabling	System components	94
	1:1 feed-through terminal block	88
	Termination carriers	97
	Analog multiplexers	95
	Multiplexers for HART signals	
Supply components	Power terminal block/error message modules/ T-Connectors/system power supply	From 89
Marking material		88
Surge protection		98
Shield fast connection		191
Test plugs		
Resistance circuit	For line fault detection	183



Isolating amplifiers with functional safety - MACX Analog



Special types of isolating amplifiers and digital displays



Ex i isolating amplifiers with functional safety - MACX Analog Ex

Page	Page	Page
From 102	131	160
106	132	160
107		161
	134	162
109		164
	150	
	151	
From 114	136	From 168
110	140	187
		165
	138	
112	141	166
		188
	142	189
	143	
	144	
From 114		From 168
	148	
	146	
116	147	170
	139	
	146	
120		172
124		176
122		174
125		177
123		175
		178
		From 179
		179
	149	149
119	149	149
118		
118		
	148	
129		184
		186
From 126		126
127		127
191	191	191
191		191
183		183

Input

Maximum input signal

The maximum input signal describes the value achieved before any damage occurs to the module and the signal generator. If these values are exceeded, suppresser diodes can be triggered to short circuit this input when a surge voltage is detected. The transmission range of the analog signals is located exclusively within the specified input ranges.

Input resistance

The input resistance of an isolating amplifier or measuring transducer is determined in such a way as to ensure that the input signal is loaded only slightly. This results in a low-resistance input for current inputs and a high-resistance input for voltage inputs.

Voltage drop

In the case of passive isolators, the input voltage drop occurs as a result of the voltage drop of the operational load and the auxiliary power requirements of the module. The greater the auxiliary power requirements of the passive isolator, the smaller the operational output load is allowed to be. Low auxiliary power requirements are regarded as an indicator of device quality.

Common mode rejection

In the case of isolating amplifiers, operational amplifiers are used internally for transmission purposes. In theory, operational amplifiers should display ideal transmission and amplification behavior. However, it is a different matter in practice. When both input voltages are changed in the same direction, i.e., exactly the same voltage to ground is applied to both input terminal blocks, this leads to an unintended output signal. Theoretically, if the operational amplifier is ideal, no output signal should appear since the differential input signal is "0 V". Common mode rejection indicates the factor (in dB) by which the common input voltage at both inputs is amplified to a lesser extent than the difference in voltage between the two inputs.

Analog output

Maximum output signal

If the devices operate without fault conditions, an overload at the input cannot cause greater values than this maximum to occur at the output.

Zero/span adjustment

When the zero point is set, the zero point of an analog output is adjusted and set in relation to the input signal.

When the "amplification" span is set, the analog output is adjusted in relation to the input signal. In this case, the output characteristic is increased or decreased by an amplification factor.

Load

The load on the output side indicates the load-carrying capacity of a measuring transducer or an isolating amplifier. Current outputs can usually drive a maximum of 500 Ω , voltage outputs can be loaded with a minimum of up to 10 k Ω .

Residual ripple/ripple

A superimposed ripple can appear on the output signal due to signal conditioning required by the circuit. The residual ripple is indicated in mV_{pp} or mV_{rms}.

Open circuit response

With some measuring transducers, the input signal is permanently monitored for possible open circuits in the signal cable. If the signal exceeds or falls below a tolerance limit, an open circuit is detected and a defined output signal is sent. With programmable devices, the output signals can be freely selected.

Digital output

Relays

Many of the products with a relay output that are shown in the catalog feature hard gold-plated relay contact material. The voltage range has an important role to play in terms of how this contact material can be used. Up to 50 mA can be transmitted with voltage ranges of up to 30 V AC/36 V DC. Even very small currents are transmitted perfectly. If the aforementioned voltage range is exceeded and values of 250 V AC/DC are processed, currents of up to 2 A can flow. However, in this case the subsequent transmission of small currents can no longer be guaranteed.

Transistor

A PNP transistor switching output can be used to transmit 24 V DC switching signals up to approximately 100 mA.

General data

Supply voltage

The product range includes DC and AC power supply units for specific products. There is a standard power supply unit available in the form of a 24 V DC version that operates within a voltage range of 20 ... 30 V DC. For other supply voltages, please refer to the technical data.

Current consumption

The value specified here describes the auxiliary power requirements of the devices. It also includes the output current and, where applicable, the switching output load.

Transmission errors

The transmission precision is a gauge of the quality of a measuring transducer. It is the deviation from the ideal transmission characteristic curve and includes linearity, span, and offset errors.

Non-linearity

Non-linearity is the deviation from the ideal transmission precision without including span and offset errors.

The non-linearity of a signal makes it possible to evaluate the course from zero to end point. Normally, the linearity errors are expressed as a percentage that indicates the extent of deviation from the ideal transmission characteristic curve.

Temperature coefficient

The temperature coefficient provides an assessment of the extent to which precision deviates when the ambient temperature around an isolating amplifier or measuring transducer changes. In most cases this is specified as a percentage. An alternative definition is ppm/K (parts per million/Kelvin). Example:
250 ppm/K = 0.025%/K.

Limit frequency

Isolating amplifiers are basically designed to transmit DC signals. However, signal changes call for a dynamic form of behavior so that small AC quantities (normally: 30 Hz) can also be transmitted. This is achieved by defining a limit frequency. At the same time, a low limit frequency can be used to suppress higher-frequency AC components.

Step response

The step response indicates the response time of the output signal when an input signal step occurs (10 ... 90%). The step response is inversely proportional to the limit frequency. This means that the response time decreases as the limit frequency increases.

Test voltage

The test voltage indicates the dielectric strength of an isolated distance and is determined by type tests. In this test, a 50 Hz voltage is applied for one minute; it describes the value achieved before a disruptive discharge is able to move to another potential level in the device.

Safe isolation

“Safe isolation” is defined as protection against hazardous shock currents. When module specifications are provided in accordance with EN 61010, a distinction is made between faultless operation and operation under fault conditions. Nominal supply voltages of 30 V AC/60 V DC are deemed valid for faultless operation.

Ambient temperature range

The temperature limits specified here relate exclusively to operation. These limits do not apply to storage and transport. It is here where the temperature limits of the materials used are the decisive factor. If the devices are outside of the specified temperature range during assembly, they must be brought back within the specified temperature range prior to system startup. It is important to make sure that no condensation occurs during this process.

Protective circuit

In order to protect the measurement and control modules against surge voltages, suppressor diodes are connected upstream of the signal and supply paths. These diodes behave in a similar manner to conventional Zener diodes, except for the fact that suppressor diodes have faster response times and a higher maximum current.

Information on directives and standards

When carrying out further processing of non-independent items of equipment (components), the applicable regulations pertaining to installation must be observed.

The relevant device-specific regulations also apply with regard to installation in devices.
(Standards applicable at the time of going to print)

Directives	EU	International
EMC Directive (electromagnetic compatibility)	2004/108/EC	-
Low Voltage Directive (LVD)	2006/95/EC	-
Ex Directive (ATEX)	94/9/EC	-
Product standards		
Electronic equipment for use in power installations	EN 50178:1997	-
Safety requirements for electrical equipment for measurement, control and laboratory use - Part 1: General requirements	EN 61010-1:2001	IEC 61010-1:2004
Programmable controllers - Part 2: Equipment requirements and tests	EN 61131-2:2007	IEC 61131-2:2007
EMC		
EMC - Part 6-2: Generic standards - Immunity for industrial environments	EN 61000-6-2:2005	IEC 61000-6-2:2005
EMC - Part 6-4: Generic standards - Emission standard for industrial environments	EN 61000-6-4:2007	IEC 61000-6-4:2006
Electrical equipment for measurement, control and laboratory use EMC requirements	EN 61326-1:2006	IEC 61326-1:2005
ATEX		
Electrical apparatus for explosive gas atmospheres - Part 0: General requirements	EN 60079-0:2006	IEC 60079-0:2007
Explosive atmospheres - Part 11: Equipment protection by intrinsic safety "i"	EN 60079-11:2007	IEC 60079-11:2006
Electrical apparatus for explosive gas atmospheres - Part 15: Construction, test and marking of type of protection "n" electrical apparatus	EN 60079-15:2005	IEC 60079-15:2005
Environmental tests		
Environmental testing - Part 2-1: Tests - Test A: Cold	EN 60068-2-1:2007	IEC 60068-2-1:2007
Environmental testing - Part 2-2: Tests - Test B: Dry heat	EN 60068-2-2:2007	IEC 60068-2-2:2007
Environmental testing - Part 2-6: Tests - Test Fc: Vibration (sinusoidal)	EN 60068-2-6:2008	IEC 60068-2-6:2008

Active isolation

3-way isolation



In the case of modules with this isolation method, all components that are connected to the input, output or power supply are protected against interference from each other. All three directions (input, output, and power supply) are electrically isolated from one another accordingly.

The 3-way isolation provides electrical isolation between the measurement sensor and the controller as well as between the controller and the actuator.

On the input side, the modules need active signals. On the output side, they provide a filtered and amplified signal.

Input isolation



In the case of modules with this isolation method, the electronics connected on the output side (e.g., the controller) are to be protected from interference from the field. For this reason, only the input is electrically isolated from the output and the power supply that are at the same potential.

On the input side, the modules need active signals (e.g., from measurement sensors). On the output side, they provide a filtered and amplified signal (e.g., from the controller).

Repeater power supply



Repeater power supplies use the signal input side not only for measured value acquisition, but also to provide the necessary power to the passive measurement sensors connected on the input side.

On the output side, they provide a filtered and amplified signal (e.g., from the controller).

The isolation method used by these modules is input isolation.

Passive isolation

Passive isolation, supplied on the input side



The modules draw the power needed for signal transmission and electrical isolation from the active input circuit. On the output side, a conditioned current signal is provided to the controller or to actuators.

This passive isolation allows signal conditioning (interruption of ground loops) and filtering without an additional power supply.

Passive isolation, supplied on the output side (loop-powered)



The modules draw the power needed for signal transmission and electrical isolation from the active output circuit, ideally from a PLC input board that supplies power.

On the output side, the loop-powered modules operate with a 4 ... 20 mA standard signal. On the input side, the passive isolator processes active signals.

When this isolation method is used, it is important to make sure that the active signal source connected on the output side (e.g., an active PLC input board) is able to supply the passive isolator with power, as well as operate its load.

Applications



Resistance thermometers

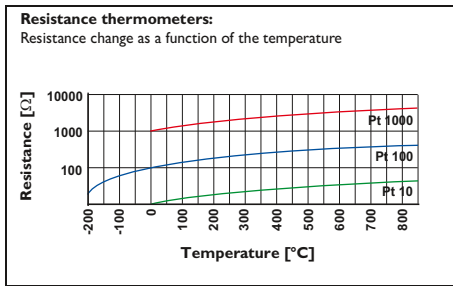

Resistance thermometers (e.g., Pt 100, Ni 1000) change their resistance value depending on the temperature. The MCR temperature transducers detect this change and convert it into a proportional analog signal.

To avoid unwanted self-heating of the sensor, the constant measured current used is kept as low as possible (MCR-T-UI... → 250 μ A).

Two-conductor connection technology

The resistance thermometer is connected to the MCR measuring transducer using a two-core cable. Please note that the supply cable resistances are added to the measured resistance and consequently distort the result.



A distance of 10 m should not be exceeded.

Example: a 50 m long copper cable with a cross section of 0.5 mm² has a specific resistance of 3.4 Ω . A Pt 100 sensor has a resistance change of 0.384 Ω per 1 K temperature change. This corresponds to an error of 8.8°C.

Three-conductor connection technology

Three-conductor technology is normally used to minimize the effect of cable resistances. An additional cable is connected to the resistance thermometer, so that the latter can be measured using two measuring circuits, one of which acts as a reference. In this way, it is possible to compensate for the cable resistance.



Identical cable lengths and an identical ambient temperature are essential here.

Since this is more or less the case in the majority of applications, three-conductor technology is the most commonly encountered today. Line compensation is not necessary.

Four-conductor connection technology

Four-conductor connection technology is an ideal connection technology for resistance thermometers.

The measurement result is affected neither by cable resistances nor by their temperature-dependent fluctuations. The voltage drop on the supply and return lines can therefore be measured and compensated for separately. Line compensation is not necessary.

Thermocouples

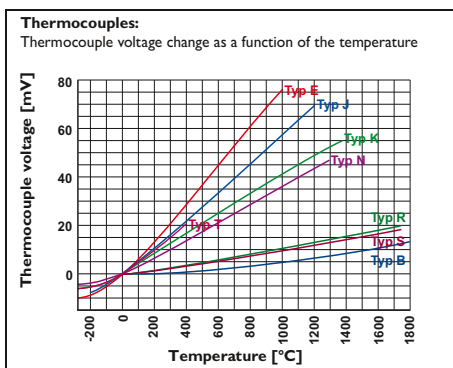

In contrast to resistance thermometers, thermocouples are active sources that generate a voltage in the microvolt range. The temperature difference measured between the measurement junction and the cold junction is converted into an absolute temperature with the help of cold junction compensation.

Operating principle:

If different metals are joined together, a thermal voltage is produced in the metal atoms as a result of the different binding energies of the electrons. This voltage is dependent firstly on the metals themselves and secondly on the temperature.

If the same temperature prevails at the measuring junction (ϑ_1) and the cold junction (ϑ_2), no current will flow because the generated partial voltages cancel each other out. However, if the temperatures at the measuring junction and the cold junction are different, different voltages are produced. These voltages do not completely cancel each other out, and so current flows.

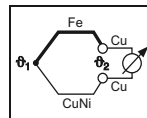

A thermocouple therefore always measures only one temperature difference. This is derived from the difference between the thermal voltages at the measuring junction and at the cold junction.

The voltage produced by the thermoelectric effect is very low; only a few microvolts per Kelvin.

Example: if a type J thermocouple (Fe-CuNi) is connected to a copper terminal block, thermal voltages with opposite polarity will be generated (at the iron-copper and copper-constantan transitions) and cancel each other out.

Therefore, only the difference in the thermal voltages between constantan (Cu-Ni) and iron is of relevance.

A role is also played by the temperature at the terminal point. If it is known, the temperature at the measuring junction can be derived by adding the thermal voltage measured at the same junction.

The MCR temperature transducers for thermocouples therefore detect the temperature at the terminal points and compensate this value, which is also referred to as the reference junction or the cold junction.

This process is sometimes called cold junction compensation.

Digital displays

Use of the freely programmable characteristic curve

The freely programmable characteristic curve, i.e., the assignment of the displayed value to the input value, is important in process applications for indicating flow rates or liquid levels.

The purpose of level measurements is very often not to determine how much liquid is still inside the tank, but rather to establish how much has been drawn out of it. In this case, the characteristic curve can simply be inverted in order to display the required value.

Parameterization of the characteristic curve using interpolation points

With non-linear input signals, the received analog values can be assigned to the value to be displayed by means of a programmable characteristic curve. This curve can consist of up to 24 interpolation points. This allows flow sensors with a non-linear characteristic curve to be adapted, for instance. The analog signal digital displays in the Function Line additionally feature a summing function which - to take a typical example from bottling technology - allows you to switch over at the touch of a button from the instantaneous value (= flow rate in

l/min) to the total flow integrated in the background, which can be displayed in any unit. This saves space and money, because there is no need for a second digital display.

Limit values can also be called at the touch of a button. Limit values 1 and 2 can be assigned to either the actual value or the cumulative value. If the latter value is exceeded, one of the two output relays is activated.

Other applications include indicating liquid levels, pressures, and temperatures. With servo motors, the analog output signals (0 ... 10 V) generated by the tachometer can be supplied to the input of the digital display in order to indicate the motor speed.

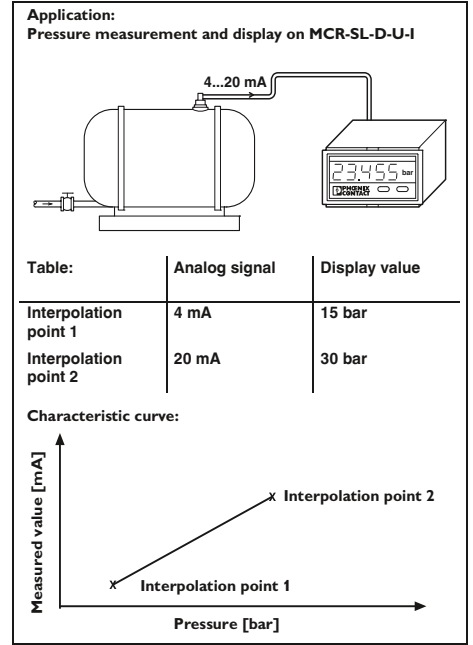

Switching behavior of relay or transistor outputs:

A different kind of switching behavior can be defined for each relay or each transistor when it reaches a preset switching point.

All the possible settings for the switching behavior are shown and explained in the list:

- The first two options include hysteresis, i.e., the behavior of the relay depends on the direction from which a switching point is reached.
- For the remaining options, with the exception of the last two ("on" and "off"), a switching tolerance is taken into account to prevent the relay contact from "chattering". The relay is not switched until the switching point plus switching tolerance has been reached.

- In the "on" state, the relay is permanently picked up. It only responds if there is an open circuit and it has been set to drop out when this happens.
- In the "off" state, the relay only responds if there is an open circuit and it has been set to pick up when this happens.

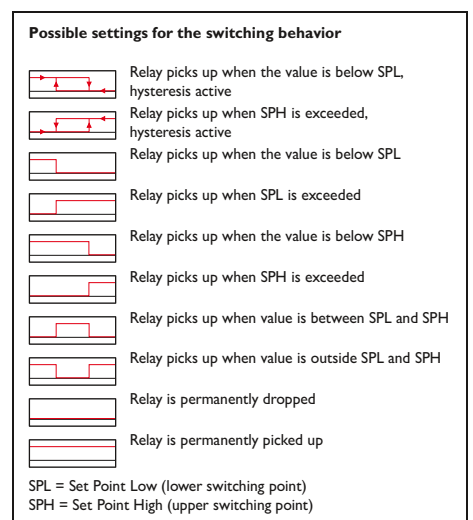

Non-intrinsically safe signal transmission in potentially explosive areas

Electrical equipment operated in systems with potentially explosive areas is subject to different usage requirements, depending on the application.

For example, electrical equipment could be used in the following locations when analog signals are being transmitted:

- Sensors and actuators can be located in zone 0, zone 1 or zone 2.
- Signal transmitters can be located in zone 1, zone 2 or the safe area.
- The controller, e.g., PLC, is in the safe area.

For examples of the kinds of electrical devices that can be installed for the purpose of transmitting signals, please see the figure.

Devices must be designed to offer a suitable protection type if they are to be used in zone 2. The MINI Analog and MACX Analog ranges are designed to provide protection type “n” for this purpose and must be installed in zone 2 in suitable and approved housing (EN 60079-15 and

EN 60079-0) with IP54 protection minimum.

Example:

A sensor/actuator with protection type “n” can be connected to an isolator from the MINI Analog or MACX Analog ranges in zone 2.

When selecting suitable devices for zone 2, it must be ensured that the electrical data of the sensors/actuators is not exceeded.

If the sensors/actuators are mounted in explosion-proof housing or if they have their own explosion-proof housing, they can also be installed in zone 1.

Installation requirements

The figure shows a range of options for installing electrical devices in areas with a danger of gas explosions. Special requirements regarding the configuration, selection, and installation of electrical systems in areas with a danger of gas explosions can be found in EN 60079-14.

In the 2008 edition, the relevant contents of EN 61241-14 were incorporated in EN 60079-14.

EN 61241-14 must still be observed when installing electrical equipment in areas containing combustible dust. Other important factors when it comes to running systems in potentially explosive areas are inspection, maintenance, and repairs. Stipulations regarding these matters can be found in EN 60079-17 and EN 60079-19.

Installation of electrical devices for signal transmission





Highly compact and efficient

MINI Analog isolating amplifiers isolate, convert, filter, and amplify your analog signals – with a design width of just 6.2 mm.

The isolating amplifiers from the MINI Analog range offer the full spectrum of analog signal conditioning. They are therefore extremely efficient with regard to saving costs, space, and energy.

The comprehensive approval package means that they can be used in a variety of areas.

Choose the right MINI Analog isolating amplifier for your application:

Analog IN/OUT

- Universal and standard 3-way isolating amplifiers
- 3-way repeater power supplies
- 4-way signal duplicators
- 2-way passive isolators
- Output loop-powered isolators

Temperature

- Universal measuring transducers for resistance thermometers and thermocouples
- Active measuring transducers for Pt 100 and thermocouples
- Output loop-powered Pt 100 measuring transducers

Frequency

- Frequency transducer up to 80 kHz
- Analog frequency transducers

Potentiometer/resistor

- Potentiometer measuring transducers with automatic potentiometer detection

Limit values

- Threshold value switches with PDT relay

Digital IN

- NAMUR isolating amplifiers with relay output

Accessories

- Supply components
- Fault monitoring module
- System cabling
- Marking material
- Surge protection

Fault monitoring

Fault monitoring is a modular solution for convenient error evaluation in multi-channel applications.

Depending on the module type, the following errors can be indicated by means of a group error message:

- Overrange
- Underrange
- Open circuit
- Short circuit
- Module error

It is also possible to detect and indicate the failure of a supply voltage at the power terminal block.

The modularity is characterized by the ability to freely adjust error evaluation, both on the device side and in the evaluation module.

Fault monitoring is compatible with and can be used for the following isolating amplifier ranges:

- MINI Analog
- MACX Analog



Space savings of up to 65%

– Compared to other isolating amplifiers on the market with design widths up to 17.5 mm.



Fault monitoring and power bridging

– The DIN rail connector simplifies supply and enables group error monitoring.



Clearly arranged wiring

– Eight connections, with a choice of screw or spring-cage terminal blocks.



Low power consumption

– The resulting minimal self-heating results in a long service life and a high degree of operational reliability.



High operational reliability

– 3-way electrical isolation increases the operational reliability against system disturbances.



Easy configuration

– Can be configured easily via DIP switches or software, for extended functionality and monitoring.



Reduction in analog inputs on controllers

– The MINI Analog multiplexer reduces up to eight analog signals to a single 4 ... 20 mA signal.



Time-saving system cabling

– Plug and play – for eight channels on the isolating amplifier and controller side.



Fast and error-free signal connection

– Compact termination carriers connect MINI Analog devices to the automation system – plug and play and hot-swappable.

Analog IN / Analog OUT
3-way isolating amplifier

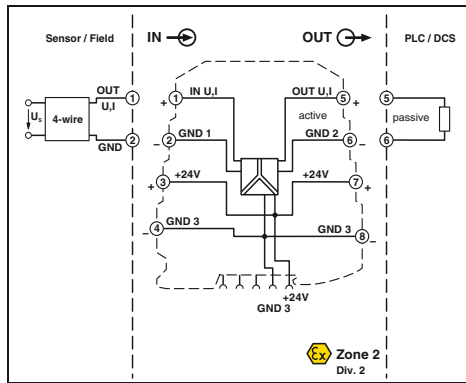
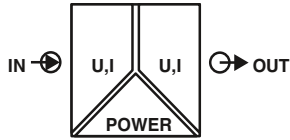

Configurable, up to 36 signal combinations

UL 15 0L Ex n
Ex: 0L Ex n
Housing width 6.2 mm

- Highly compact isolating amplifier for electrical isolation, conversion, amplification, and filtering of standard analog signals
- Up to 36 signal combinations can be configured using DIP switches
- 3-way isolation
- Low power consumption
- Power supply possible through the foot element (T-Connector)
- Standard configuration:
0 ... 10 V input, 0 ... 20 mA output

Notes:
To order a product with an order configuration, enter the required configuration by referring to the adjacent order key.
Information about power bridging, system cabling, and marking components can be found starting at page 88
1) EMC: Class A product, see page 571

Input data	Input signal	0 ... 5 V / 1 ... 5 V 0 ... 10 V / 2 ... 10 V
Input resistance	Approx. 100 kΩ	
Output data	Output signal	0 ... 5 V / 1 ... 5 V 0 ... 10 V / 2 ... 10 V
Maximum output signal	No-load voltage	Approx. 12.5 V
Short-circuit current	Load R_B	28 mA
Ripple	Approx. 22 mA	
General data	Supply voltage U_B	19.2 V DC ... 30 V DC
Nominal supply voltage	24 V DC	
Current consumption	< 9 mA (Voltage output, at 24 V DC incl. load)	< 19 mA (Current output, at 24 V DC incl. load)
Power consumption	< 200 mW (Voltage output)	< 450 mW (Current output)
Maximum transmission error	≤ 0.1% (of final value)	
Temperature coefficient	< 0.01%/K, typ. < 0.002%/K	
Limit frequency (3 dB)	Approx. 100 Hz	
Step response (10 - 90%)	Approx. 3.2 ms	
Electrical isolation	Basic insulation according to EN 61010	
Test voltage, input/output/supply	1.5 kV (50 Hz, 1 min.)	
Degree of protection	IP20	
Ambient temperature (operation)	-20°C ... 65°C	
Mounting	Any	
Housing material	PBT	
Dimensions W / H / D	6.2 / 93.1 / 102.5 mm	
Screw connection solid / stranded / AWG	0.2 ... 2.5 mm ² / 0.2 ... 2.5 mm ² / 26 - 12	
Spring-cage connection (solid/stranded/AWG)	0.2 ... 2.5 mm ² / 0.2 ... 2.5 mm ² / 24 - 12	
Conformance / approvals	CE-compliant	
Conformance	Ex II 3 G Ex nA IIC T4 Gc X	
ATEX	UL 508 Recognized	
UL, USA / Canada	Class I, Div. 2, Groups A, B, C, D T5	
GL	GL EMC 2 D	

Technical data		
U input	I input	
0 ... 5 V / 1 ... 5 V	0 ... 20 mA / 4 ... 20 mA	
0 ... 10 V / 2 ... 10 V		
Approx. 100 kΩ	Approx. 50 Ω	
U output	I output	
0 ... 5 V / 1 ... 5 V	0 ... 20 mA / 4 ... 20 mA	
0 ... 10 V / 2 ... 10 V		
Approx. 12.5 V	28 mA	
	Approx. 12.5 V	
Approx. 22 mA		
≥ 10 kΩ	< 500 Ω (at 20 mA)	
< 20 mV _{pp} (at 10 kΩ)	< 20 mV _{pp} (at 500 Ω)	
U output	I output	
19.2 V DC ... 30 V DC		
24 V DC		
< 9 mA (Voltage output, at 24 V DC incl. load)	< 19 mA (Current output, at 24 V DC incl. load)	
< 200 mW (Voltage output)	< 450 mW (Current output)	
Ordering data		
Type	Order No.	Pcs. / Pkt.
MINI MCR-SL-UI-UI ¹⁾	2864383	1
MINI MCR-SL-UI-UI-SP ¹⁾	2864710	1
MINI MCR-SL-UI-UI-NC ¹⁾	2864150	1
MINI MCR-SL-UI-UI-SP-NC ¹⁾	2864163	1

Description	
MCR 3-way isolating amplifier , for electrical isolation of analog signals,	
Order configuration	Screw connection
Order configuration	Spring-cage conn.
Standard configuration	Screw connection
Standard configuration	Spring-cage conn.

Order key MINI MCR-SL-UI-UI (Standard configuration entered as example)

Order No.	Input	Output	Factory calibration certificate
2864383	IN03	OUT01	NONE
2864383 ≙ ...-UI-UI	IN01 ≙ 0...20 mA IN02 ≙ 4...20 mA IN03 ≙ 0...10 V	OUT01 ≙ 0...20 mA OUT02 ≙ 4...20 mA OUT03 ≙ 0...10 V	NONE ≙ Without factory YES ≙ With factory calibration certificate (fee)
2864710 ≙ ...-UI-UI-SP	IN04 ≙ 2...10 V IN05 ≙ 0...5 V IN06 ≙ 1...5 V	OUT04 ≙ 2...10 V OUT05 ≙ 0...5 V OUT06 ≙ 1...5 V	YESPLUS ≙ Factory calibration certificate with 5 measuring points (fee)

Combination table for input and output signals

Input	Output	DIP switch SW 2						DIP switch SW 1	
		DIP 1	DIP 2	DIP 3	DIP 4	DIP 5	DIP 6	DIP 1	DIP 2
0 - 10 V	0 - 20 mA	OFF	OFF	OFF	OFF	OFF	OFF	OFF	OFF
	4 - 20 mA	OFF	OFF	OFF	OFF	OFF	ON	OFF	OFF
	0 - 10 V	ON	OFF	ON	OFF	OFF	OFF	OFF	OFF
	2 - 10 V	ON	OFF	ON	OFF	OFF	ON	OFF	OFF
	0 - 5 V	ON	ON	OFF	OFF	OFF	OFF	OFF	OFF
	1 - 5 V	ON	ON	OFF	OFF	OFF	ON	OFF	OFF
2 - 10 V	0 - 20 mA	OFF	OFF	OFF	ON	ON	OFF	OFF	OFF
	4 - 20 mA	OFF	OFF	OFF	OFF	OFF	OFF	OFF	OFF
	0 - 10 V	ON	OFF	ON	ON	ON	OFF	OFF	OFF
	2 - 10 V	ON	OFF	ON	OFF	OFF	OFF	OFF	OFF
	0 - 5 V	ON	ON	OFF	ON	ON	OFF	OFF	OFF
	1 - 5 V	ON	ON	OFF	OFF	OFF	OFF	OFF	OFF
0 - 5 V	0 - 20 mA	OFF	OFF	OFF	OFF	OFF	OFF	ON	OFF
	4 - 20 mA	OFF	OFF	OFF	OFF	OFF	ON	ON	OFF
	0 - 10 V	ON	OFF	ON	OFF	OFF	OFF	ON	OFF
	2 - 10 V	ON	OFF	ON	OFF	OFF	ON	ON	OFF
	0 - 5 V	ON	ON	OFF	OFF	OFF	OFF	ON	OFF
	1 - 5 V	ON	ON	OFF	OFF	OFF	ON	ON	OFF
1 - 5 V	0 - 20 mA	OFF	OFF	OFF	ON	ON	OFF	ON	OFF
	4 - 20 mA	OFF	OFF	OFF	OFF	OFF	OFF	ON	OFF
	0 - 10 V	ON	OFF	ON	ON	ON	OFF	ON	OFF
	2 - 10 V	ON	OFF	ON	OFF	OFF	OFF	ON	OFF
	0 - 5 V	ON	ON	OFF	ON	ON	OFF	ON	OFF
	1 - 5 V	ON	ON	OFF	OFF	OFF	OFF	ON	OFF
0 - 20 mA	0 - 20 mA	OFF	OFF	OFF	OFF	OFF	OFF	OFF	ON
	4 - 20 mA	OFF	OFF	OFF	OFF	OFF	ON	OFF	ON
	0 - 10 V	ON	OFF	ON	OFF	OFF	OFF	OFF	ON
	2 - 10 V	ON	OFF	ON	OFF	OFF	ON	OFF	ON
	0 - 5 V	ON	ON	OFF	OFF	OFF	OFF	OFF	ON
	1 - 5 V	ON	ON	OFF	OFF	OFF	ON	OFF	ON
4 - 20 mA	0 - 20 mA	OFF	OFF	OFF	ON	ON	OFF	OFF	ON
	4 - 20 mA	OFF	OFF	OFF	OFF	OFF	OFF	OFF	ON
	0 - 10 V	ON	OFF	ON	ON	ON	OFF	OFF	ON
	2 - 10 V	ON	OFF	ON	OFF	OFF	OFF	OFF	ON
	0 - 5 V	ON	ON	OFF	ON	ON	OFF	OFF	ON
	1 - 5 V	ON	ON	OFF	OFF	OFF	OFF	OFF	ON

Application example: Level measurement



Analog IN / Analog OUT
3-way isolating amplifier



Ex n



Configurable, for shunt measurements



Housing width 6.2 mm

- Highly compact isolating amplifier for electrical isolation, conversion, amplification, and filtering of mV signals to create standard analog signals
- Ideal for converting signals in the case of shunt measurements
- Up to 280 signal combinations can be configured using DIP switches
- 3-way isolation
- Low power consumption
- Power supply possible through the foot element (T-Connector)
- Standard configuration:
0 ... 50 mV input, 0 ... 20 mA output

Notes:
To order a product with an order configuration, enter the required configuration by referring to the adjacent order key.
Information about power bridging, system cabling, and marking components can be found starting at page 88
1) EMC: Class A product, see page 571

Input data	Input signal (can be configured using DIP switches)
	Maximum input signal
	Input resistance
Output data	Output signal (configurable using the DIP switch)
	Maximum output signal
	Load R _B
	Ripple
General data	Supply voltage U _B
	Nominal supply voltage
	Power consumption
	Maximum transmission error
	Temperature coefficient
	Limit frequency (3 dB)
	Step response (10 - 90%)
	Electrical isolation
	Test voltage, input/output/supply
	Degree of protection
	Ambient temperature (operation)
	Mounting
	Housing material
	Dimensions W / H / D
	Screw connection solid / stranded / AWG
	Spring-cage connection (solid/stranded/AWG)
Conformance / approvals	Conformance
	ATEX
	UL, USA / Canada
	GL

Technical data	
0 ... 50 mV	
Approx. 30 V DC	
Approx. 10 kΩ	
U output	I output
0 ... 5 V / 1 ... 5 V	0 ... 20 mA / 4 ... 20 mA
0 ... 10 V / 2 ... 10 V	
-5 ... 5 V / -10 ... 10 V	
(The bi-polar output can be used only for bi-polar input signals.)	

12.5 V	28 mA
≥ 10 kΩ	< 500 Ω (at 20 mA)
< 20 mV _{pp} (at 10 kΩ)	< 20 mV _{pp} (at 500 Ω)

19.2 V DC ... 30 V DC
24 V DC
< 450 mW (Current output)
≤ 0.2%
< 0.01%/K, typ. < 0.002%/K (100 Hz / 30 Hz switchable)
3.5 ms (At 100 Hz)
Basic insulation according to EN 61010
1.5 kV (50 Hz, 1 min.)
IP20
-20°C ... 65°C
Any
PBT
6.2 / 93.1 / 102.5 mm
0.2 ... 2.5 mm ² / 0.2 ... 2.5 mm ² / 26 - 12
0.2 ... 2.5 mm ² / 0.2 ... 2.5 mm ² / 24 - 12

CE-compliant
Ex II 3 G Ex nA IIC T4 Gc X
UL 508 Recognized
Class I, Div. 2, Groups A, B, C, D T5 applied for
GL EMC 2 D

Ordering data		
Type	Order No.	Pcs. / Pkt.
MINI MCR-SL-SHUNT-UI	2810858	1
MINI MCR-SL-SHUNT-UI-SP	2810874	1
MINI MCR-SL-SHUNT-UI-NC ¹⁾	2810780	1
MINI MCR-SL-SHUNT-UI-SP-NC ¹⁾	2810793	1

Description	
MINI 3-way isolating amplifier, for realization of mV voltages in standard signals,	
Order configuration	Screw connection
Order configuration	Spring-cage conn.
Standard configuration	Screw connection
Standard configuration	Spring-cage conn.

Order key MINI MCR-SL-SHUNT-UI-... (standard configuration entered as an example)

Order No.	Input				Output	Limit frequency	Factory calibration certificate FCC
2810858	IN40				OUT01	100	NONE
2810858 ≙ ...SHUNT-UI	IN40 ≙ 0...50 mV IN24 ≙ 0...60 mV IN41 ≙ 0...75 mV IN42 ≙ 0...80 mV IN25 ≙ 0...100 mV IN43 ≙ 0...120 mV IN44 ≙ 0...150 mV IN26 ≙ 0...200 mV IN45 ≙ 0...240 mV IN27 ≙ 0...300 mV	IN28 ≙ 0...500 mV IN46 ≙ 0...600 mV IN47 ≙ 0...750 mV IN48 ≙ 0...800 mV IN29 ≙ 0...1.0 V IN49 ≙ 0...1.2 V IN50 ≙ 0...1.5 V IN30 ≙ 0...2.0 V IN51 ≙ 0...2.4 V IN52 ≙ 0...3.0 V	IN53 ≙ -50...+50 mV IN13 ≙ -60...+60 mV IN54 ≙ -75...+75 mV IN55 ≙ -80...+80 mV IN14 ≙ -100...+100 mV IN56 ≙ -120...+120 mV IN57 ≙ -150...+150 mV IN15 ≙ -200...+200 mV IN58 ≙ -240...+240 mV IN16 ≙ -300...+300 mV	IN17 ≙ -500...+500 mV IN59 ≙ -600...+600 mV IN60 ≙ -750...+750 mV IN61 ≙ -800...+800 mV IN18 ≙ -1.0...+1.0 V IN62 ≙ -1.2...+1.2 V IN63 ≙ -1.5...+1.5 V IN19 ≙ -2.0...+2.0 V IN64 ≙ -2.4...+2.4 V IN65 ≙ -3.0...+3.0 V	OUT01 ≙ 0...20 mA OUT02 ≙ 4...20 mA OUT03 ≙ 0...10 V OUT04 ≙ 2...10 V OUT05 ≙ 0...5 V OUT06 ≙ 1...5 V OUT13 ≙ -5...+5 V OUT14 ≙ -10...+10 V	30 ≙ 30 Hz 100 ≙ 100 Hz	NONE ≙ without FCC YES ≙ with FCC (a fee is charged) YESPLUS ≙ Factory calibration certificate with 5 measuring points (a fee is charged)

Note:

A bipolar output (-5...+5 V, -10...+10 V) can only be used for a bipolar input signal.

Combination table for input and output signals

Input	Voltage output						Current output	
	-10...+10 V	0...10 V	2...10 V	-5...+5 V	0...5 V	1...5 V	0...20 mA	4...20 mA
0...50 mV		x			x	x	x	x
0...60 mV		x	x		x	x	x	x
0...75 mV		x	x		x	x	x	x
0...80 mV		x	x		x	x	x	x
0...100 mV		x	x		x	x	x	x
0...120 mV		x	x		x	x	x	x
0...150 mV		x	x		x	x	x	x
0...200 mV		x	x		x	x	x	x
0...240 mV		x	x		x	x	x	x
0...300 mV		x	x		x	x	x	x
0...500 mV		x	x		x	x	x	x
0...600 mV		x	x		x	x	x	x
0...750 mV		x	x		x	x	x	x
0...800 mV		x	x		x	x	x	x
0...1 V		x	x		x	x	x	x
0...1.2 V		x	x		x	x	x	x
0...1.5 V		x	x		x	x	x	x
0...2 V		x	x		x	x	x	x
0...2.4 V		x	x		x	x	x	x
0...3 V		x	x		x	x	x	x
-50...50 mV	x	x	x	x	x	x	x	x
-60...60 mV	x	x	x	x	x	x	x	x
-75...75 mV	x	x	x	x	x	x	x	x
-80...80 mV	x	x	x	x	x	x	x	x
-100...100 mV	x	x	x	x	x	x	x	x
-120...120 mV	x	x	x	x	x	x	x	x
-150...150 mV	x	x	x	x	x	x	x	x
-200...200 mV	x	x	x	x	x	x	x	x
-240...240 mV	x	x	x	x	x	x	x	x
-300...300 mV	x	x	x	x	x	x	x	x
-500...500 mV	x	x	x	x	x	x	x	x
-600...600 mV	x	x	x	x	x	x	x	x
-750...750 mV	x	x	x	x	x	x	x	x
-800...800 mV	x	x	x	x	x	x	x	x
-1...1 V	x	x	x	x	x	x	x	x
-1.2...1.2 V	x	x	x	x	x	x	x	x
-1.5...1.5 V	x	x	x	x	x	x	x	x
-2...2 V	x	x	x	x	x	x	x	x
-2.4...2.4 V	x	x	x	x	x	x	x	x
-3...3 V	x	x	x	x	x	x	x	x

Application example: Monitoring of loading and unloading currents

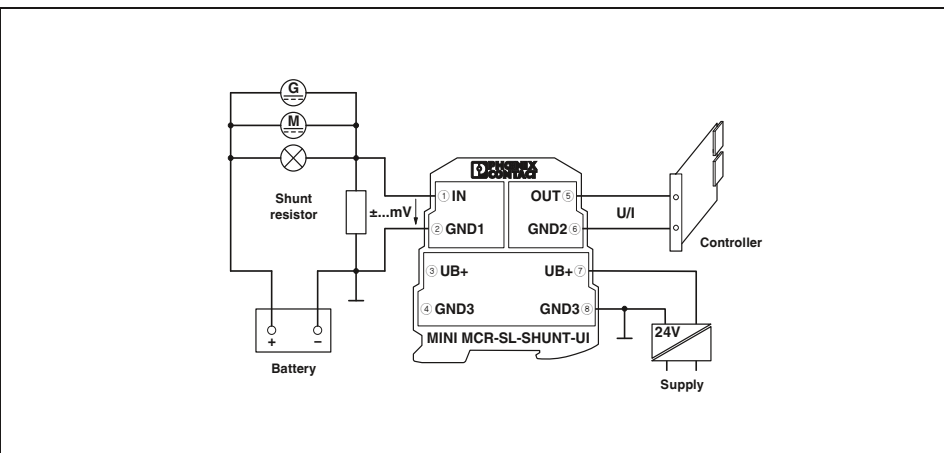

Analog IN / Analog OUT
3-way isolating amplifier

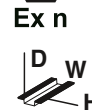

Configurable,
for 0 ... 24 V / 0 ... 30 V input signals



Housing width 6.2 mm

- Highly compact isolating amplifier for electrical isolation, conversion, amplification, and filtering of 24 V or 30 V DC signals to create standard analog signals
- Up to 12 signal combinations can be configured using DIP switches
- 3-way isolation
- Low power consumption
- Power supply possible through the foot element (T-Connector)
- Standard configuration:
0 ... 30 V input, 0 ... 20 mA output

Notes:

To order a product with an order configuration, please enter the desired configuration by referring to the order key; see below.

Information about power bridging, system cabling, and marking components can be found starting at page 88

1) EMC: Class A product, see page 571

Input data	
Input signal	0 ... 24 V / 0 ... 30 V
Input resistance	Approx. 125 kΩ (0 ... 24 V)
Output data	
Output signal (configurable using the DIP switch)	U output I output
	0 ... 5 V / 1 ... 5 V 0 ... 20 mA / 4 ... 20 mA
	0 ... 10 V / 2 ... 10 V
	≤ 12.5 V 28 mA
	≤ 12.5 V
	≤ 22 mA
	> 10 kΩ < 500 Ω (at 20 mA)
	< 20 mV _{pp} (at 10 kΩ) < 20 mV _{pp} (at 500 Ω)
General data	
Supply voltage U _B	19.2 V DC ... 30 V DC
Power consumption	< 450 mW
Maximum transmission error	< 0.1% (of final value)
Temperature coefficient	< 0.01%/K, typ. < 0.002%/K
Limit frequency (3 dB)	Approx. 100 Hz
Step response (10 - 90%)	Approx. 3.5 ms
Electrical isolation	Basic insulation according to EN 61010
Test voltage, input/output/supply	1.5 kV (50 Hz, 1 min.)
Ambient temperature (operation)	-20°C ... 65°C
Housing material	PBT
Dimensions W / H / D	6.2 / 93.1 / 102.5 mm
Screw connection solid / stranded / AWG	0.2 ... 2.5 mm ² / 0.2 ... 2.5 mm ² / 26 - 12
Spring-cage connection (solid/stranded/AWG)	0.2 ... 2.5 mm ² / 0.2 ... 2.5 mm ² / 24 - 12
Conformance / approvals	
Conformance	CE-compliant
ATEX	Ex n II 3 G Ex nA IIC T4 Gc X
UL, USA / Canada	UL 508 Recognized
	Class I, Div. 2, Groups A, B, C, D T5
GL	GL EMC 2 D

Technical data		
	0 ... 24 V / 0 ... 30 V	
	Approx. 125 kΩ (0 ... 24 V)	
U output		I output
	0 ... 5 V / 1 ... 5 V	0 ... 20 mA / 4 ... 20 mA
	0 ... 10 V / 2 ... 10 V	
	≤ 12.5 V	28 mA
		≤ 12.5 V
	≤ 22 mA	
	> 10 kΩ	< 500 Ω (at 20 mA)
	< 20 mV _{pp} (at 10 kΩ)	< 20 mV _{pp} (at 500 Ω)
Ordering data		
	CE-compliant	
	Ex n II 3 G Ex nA IIC T4 Gc X	
	UL 508 Recognized	
	Class I, Div. 2, Groups A, B, C, D T5	
	GL EMC 2 D	

Description	
MCR 3-way isolating amplifier , for electrical isolation of analog signals.	
Order configuration	Screw connection
Order configuration	Spring-cage conn.
Standard configuration	Screw connection
Standard configuration	Spring-cage conn.

Type	Order No.	Pcs. / Pkt.
MINI MCR-SL-U-UI ¹⁾	2864053	1
MINI MCR-SL-U-UI-SP ¹⁾	2811213	1
MINI MCR-SL-U-UI-NC ¹⁾	2865007	1
MINI MCR-SL-U-UI-SP-NC ¹⁾	2810078	1

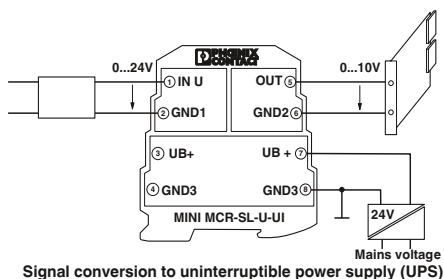

Order key MINI MCR-SL-U-UI (standard configuration entered as example)

Order No.	Input	Output
2864053	IN39	OUT01
2864053 ≙ ...-U-UI	IN38 ≙ 0...24 V IN39 ≙ 0...30 V	OUT01 ≙ 0...20 mA OUT02 ≙ 4...20 mA OUT03 ≙ 0...10 V OUT04 ≙ 2...10 V OUT05 ≙ 0...5 V OUT06 ≙ 1...5 V
2811213 ≙ ...-U-UI-SP		

Analog IN / Analog OUT
3-way isolating amplifier



With fixed signal combinations



- Highly compact isolating amplifier for electrical isolation, conversion, amplification, and filtering of standard analog signals
- Fixed signal combinations
- Entry-level alternative to configurable isolating amplifiers
- 3-way isolation
- Low power consumption
- Power supply possible through the foot element (T-Connector)

Notes:
Information about power bridging, system cabling, and marking components can be found starting at page 88
1) EMC: Class A product, see page 571

Input data	U input	I input
Input resistance	Approx. 100 kΩ	Approx. 50 Ω
Output data	U output	I output
Maximum output signal	12.5 V	28 mA
No-load voltage		Approx. 12.5 V
Short-circuit current	Approx. 2 mA	
Load R _B	≥ 10 kΩ	≤ 500 Ω
Ripple	< 20 mV _{pp} (at 10 kΩ)	< 20 mV _{pp} (at 500 Ω)
General data	Supply voltage U _B	
Supply voltage U _B	19.2 V DC ... 30 V DC	
Nominal supply voltage	24 V DC	
Current consumption	< 20 mA	
Maximum transmission error	≤ 0.1% (of final value)	
Temperature coefficient	< 0.01%/K, typ. < 0.002%/K	
Limit frequency (3 dB)	Approx. 100 Hz	
Step response (10 - 90%)	Approx. 3.5 ms	
Degree of protection	IP20	
Electrical isolation	Basic insulation according to EN 61010	
Test voltage, input/output/supply	1.5 kV (50 Hz, 1 min.)	
Ambient temperature (operation)	-20°C ... 65°C	
Housing material	PBT	
Dimensions W / H / D	6.2 / 93.1 / 102.5 mm	
Screw connection solid / stranded / AWG	0.2 ... 2.5 mm ² / 0.2 ... 2.5 mm ² / 26 - 12	
Spring-cage connection (solid/stranded/AWG)	0.2 ... 2.5 mm ² / 0.2 ... 2.5 mm ² / 24 - 12	
Conformance / approvals	CE-compliant	
Conformance	Ex II 3 G Ex nA IIC T4 Gc X	
ATEX	UL 508 Recognized	
UL, USA / Canada	Class I, Div. 2, Groups A, B, C, D T5 applied for	
GL	GL EMC 2 D	

Technical data		
U input	I input	
Approx. 100 kΩ	Approx. 50 Ω	
U output	I output	
12.5 V	28 mA	
Approx. 2 mA		
≥ 10 kΩ	≤ 500 Ω	
< 20 mV _{pp} (at 10 kΩ)	< 20 mV _{pp} (at 500 Ω)	
General data		
Supply voltage U _B		
19.2 V DC ... 30 V DC		
24 V DC		
< 20 mA		
≤ 0.1% (of final value)		
< 0.01%/K, typ. < 0.002%/K		
Approx. 100 Hz		
Approx. 3.5 ms		
IP20		
Basic insulation according to EN 61010		
1.5 kV (50 Hz, 1 min.)		
-20°C ... 65°C		
PBT		
6.2 / 93.1 / 102.5 mm		
0.2 ... 2.5 mm ² / 0.2 ... 2.5 mm ² / 26 - 12		
0.2 ... 2.5 mm ² / 0.2 ... 2.5 mm ² / 24 - 12		
Conformance / approvals		
CE-compliant		
Ex II 3 G Ex nA IIC T4 Gc X		
UL 508 Recognized		
Class I, Div. 2, Groups A, B, C, D T5 applied for		
GL EMC 2 D		

Description	Input signal	Output signal
MCR 3-way isolating amplifier , for electrical isolation of analog signals,		
Screw connection	0 ... 10 V	0 ... 20 mA
Spring-cage conn.	0 ... 10 V	0 ... 20 mA
Screw connection	0 ... 10 V	4 ... 20 mA
Spring-cage conn.	0 ... 10 V	4 ... 20 mA
Screw connection	0 ... 20 mA	0 ... 10 V
Spring-cage conn.	0 ... 20 mA	0 ... 10 V
Screw connection	4 ... 20 mA	0 ... 10 V
Spring-cage conn.	4 ... 20 mA	0 ... 10 V
Screw connection	0 ... 20 mA	0 ... 20 mA
Spring-cage conn.	0 ... 20 mA	0 ... 20 mA
Screw connection	4 ... 20 mA	4 ... 20 mA
Spring-cage conn.	4 ... 20 mA	4 ... 20 mA
Screw connection	0 ... 10 V	0 ... 10 V
Spring-cage conn.	-10 ... 10 V	-10 ... 10 V
Screw connection	0 ... 10 V	0 ... 10 V
Spring-cage conn.	-10 ... 10 V	-10 ... 10 V

Ordering data		
Type	Order No.	Pcs. / Pkt.
MINI MCR-SL-U-I-0 ¹⁾	2813512	1
MINI MCR-SL-U-I-0-SP ¹⁾	2813570	1
MINI MCR-SL-U-I-4 ¹⁾	2813525	1
MINI MCR-SL-U-I-4-SP ¹⁾	2813583	1
MINI MCR-SL-I-U-0 ¹⁾	2813541	1
MINI MCR-SL-I-U-0-SP ¹⁾	2813554	1
MINI MCR-SL-I-U-4 ¹⁾	2813538	1
MINI MCR-SL-I-U-4-SP ¹⁾	2813567	1
MINI MCR-SL-I-I ¹⁾	2864406	1
MINI MCR-SL-I-I-SP ¹⁾	2864723	1
MINI MCR-SL-U-U ¹⁾	2864684	1
MINI MCR-SL-U-U-SP ¹⁾	2864697	1

Analog IN/Analog OUT signal duplicators

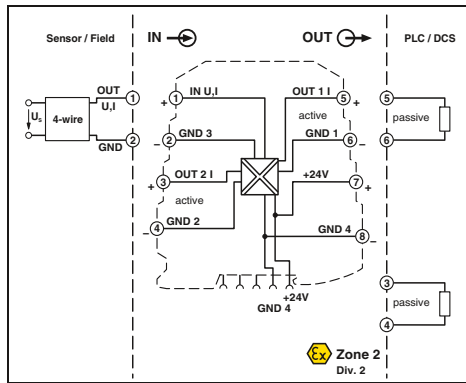
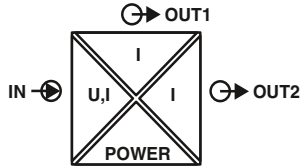

Configurable, with two current output signals



Housing width 6.2 mm

- Highly compact isolating amplifier for electrical isolation, conversion, amplification, filtering, and duplication of standard analog signals
- Duplication of a standard analog signal on two current outputs
- Up to 8 signal combinations can be configured using DIP switches
- 4-way isolation
- Power supply possible through the foot element (T-Connector)
- Standard configuration:
Input: 0 ... 10 V, output 1: 0 ... 20 mA, output 2: 0 ... 20 mA

Notes:
To order a product with an order configuration, please enter the desired configuration by referring to the order key; see below.
Information about power bridging, system cabling, and marking components can be found starting at page 88
1) EMC: Class A product, see page 571

Input data
Input signal
Maximum input signal
Input resistance
Output data
Output signal (configurable using the DIP switch)
Maximum output signal
No-load voltage
Load R_B
Ripple
General data
Supply voltage U_B
Current consumption
Power consumption
Maximum transmission error
Temperature coefficient
Limit frequency (3 dB)
Step response (0 - 99%)
Electrical isolation
Test voltage, input/output/supply
Ambient temperature (operation)
Housing material
Dimensions W / H / D
Screw connection solid / stranded / AWG
Spring-cage connection (solid/stranded/AWG)
Conformance / approvals
Conformance
ATEX
UL, USA / Canada
GL

Technical data	
U input	I input
0 ... 10 V / 1 ... 5 V	0 ... 20 mA / 4 ... 20 mA
30 V	50 mA
Approx. 100 kΩ	Approx. 50 Ω
2x ; 0 ... 20 mA / 4 ... 20 mA	
22 mA	
9 V	
≤ 250 Ω (at 20 mA)	
< 20 mV _{PP} (at 250 Ω)	
19.2 V DC ... 30 V DC	
< 30 mA (at 24 V DC incl. load)	
< 600 mW	
≤ 0.2% (of final value), typ. < 0.1%	
< 0.01%/K, typ. < 0.004%/K	
Approx. 35 Hz	
Approx. 10 ms	
Basic insulation according to EN 61010	
1.5 kV (50 Hz, 1 min.)	
-20°C ... 60°C	
PBT	
6.2 / 93.1 / 102.5 mm	
0.2 ... 2.5 mm ² / 0.2 ... 2.5 mm ² / 26 - 12	
0.2 ... 2.5 mm ² / 0.2 ... 2.5 mm ² / 24 - 12	
CE-compliant	
Ex II 3 G Ex nA IIC T4 Gc X	
UL 508 Recognized	
Class I, Div. 2, Groups A, B, C, D T5	
GL EMC 2 D	

Description	
MCR signal duplicator , for duplication and electrical isolation of analog signals	
Order configuration	Screw connection
Order configuration	Spring-cage conn.
Standard configuration	Screw connection
Standard configuration	Spring-cage conn.

Ordering data		
Type	Order No.	Pcs. / Pkt.
MINI MCR-SL-UI-2I ¹⁾	2864794	1
MINI MCR-SL-UI-2I-SP ¹⁾	2864804	1
MINI MCR-SL-UI-2I-NC ¹⁾	2864176	1
MINI MCR-SL-UI-2I-SP-NC ¹⁾	2864189	1

Order key for MINI MCR-SL-UI-2I (standard configuration entered as an example)

Order No.	Input	Output combination ¹⁾	Behavior of the analog outputs	Factory calibration certificate (FCC)
2864794	IN03	A	0	NONE
2864794 ≙ ...-UI-2I	IN01 ≙ 0...20 mA IN02 ≙ 4...20 mA IN03 ≙ 0...10 V IN06 ≙ 1...5 V	A B C	0 ≙ Analog behavior 1 ≙ Limitation	NONE ≙ without FCC YES ≙ with FCC (a fee is charged) YESPLUS ≙ FCC with 5 measuring points (a fee is charged)
2864804 ≙ ...-UI-2I-SP				

Explanation for output combination:

	Output 1	Output 2
A	0...20 mA	0...20 mA
B	0...20 mA	4...20 mA
C	4...20 mA	4...20 mA

¹⁾ For explanations, see adjacent text on the right; for further details, see data sheet: www.phoenixcontact.net/products

Analog IN / Analog OUT
repeater power supplies

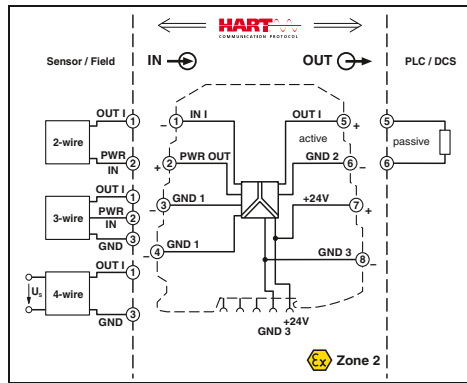

Optionally available with HART transmission



Housing width 6.2 mm

- Highly compact repeater power supplies for electrical isolation, amplification, and filtering of standard analog signals
- Supply of 2-conductor and passive 3-conductor sensors
- Can also be used as an isolator without supply
- 3-way isolation
- Alternatively bidirectional HART transmission
- Power supply possible through the foot element (T-Connector)

Notes:

Information about power bridging, system cabling, and marking components can be found starting at page 73

1) EMC: Class A product, see page 571

Input data

Input signal
Input resistance
Transmitter supply voltage

Output data

Output signal
Maximum output signal
No-load voltage
Load R_B
Ripple

General data

Supply voltage U_B
Nominal supply voltage
Current consumption
Power consumption

Maximum transmission error

Temperature coefficient
Limit frequency (3 dB)
Communication

Step response (10 - 90%)

Electrical isolation
Test voltage, input/output/supply
Degree of protection
Ambient temperature (operation)
Mounting
Housing material
Dimensions W / H / D
Screw connection solid / stranded / AWG

Spring-cage connection (solid/stranded/AWG)

Conformance / approvals

Conformance
ATEX
UL, USA / Canada

GL

Technical data

MINI MCR-SL-RPSS-I-I ¹⁾	MINI MCR-SL-RPS-I-I ¹⁾
0 ... 20 mA, isolator operation / 4 ... 20 mA	0 ... 20 mA, isolator operation / 4 ... 20 mA
Approx. 50 Ω 16.5 V	Approx. 50 Ω 14.7 V DC ... 25.5 V DC (U_B - max. 4.5 V for load 0 mA ... 20 mA)
0 ... 20 mA / 4 ... 20 mA 21 mA	0 ... 20 mA / 4 ... 20 mA 28 mA
Approx. 12.5 V $\leq 500 \Omega$ (at $I = 20$ mA) < 20 mV _{rms} (at 500 Ω)	Approx. 12.5 V $\leq 500 \Omega$ (at $I = 20$ mA) < 20 mV _{rms} (at 500 Ω)
20.4 V DC ... 30 V DC 24 V DC	19.2 V DC ... 30 V DC 24 V DC
< 900 mW (at 24 V DC and in repeater power supply operation)	< 900 mW (at 24 V DC and in repeater power supply operation)
$\leq 0.2\%$ (of final value), typ. $\leq 0.1\%$ (of final value)	$\leq 0.2\%$ (of final value), typ. $\leq 0.1\%$ (of final value)
$< 0.005\%/K$, typ. $< 0.002\%/K$ 175 Hz (typ.) HART specification in both operating modes (RPSS isolator / RPSS repeater power supply)	$< 0.01\%/K$, typ. $< 0.002\%/K$ Approx. 100 Hz -
< 2 ms (typ.) Basic insulation according to EN 61010	Approx. 3.5 ms 1.5 kV (50 Hz, 1 min.) IP20 -20°C ... 60°C
1.5 kV (50 Hz, 1 min.) IP20 -20°C ... 60°C	1.5 kV (50 Hz, 1 min.) IP20 -20°C ... 60°C
Any PBT 6.2 / 93.1 / 102.5 mm 0.2 ... 2.5 mm ² / 0.2 ... 2.5 mm ² / 26 - 12	Any PBT 6.2 / 93.1 / 102.5 mm 0.2 ... 2.5 mm ² / 0.2 ... 2.5 mm ² / 24 - 12
0.2 ... 2.5 mm ² / 0.2 ... 2.5 mm ² / 24 - 12	
CE-compliant Ex II 3 G Ex nA IIC T4 Gc X UL 508 Recognized applied for Class I, Div. 2, Groups A, B, C, D T5 applied for GL EMC 2 D	CE-compliant Ex II 3 G Ex nA IIC T4 Gc X UL 508 Recognized Class I, Div. 2, Groups A, B, C, D T5 GL EMC 2 D

Ordering data

Description

MCR repeater power supplies

with HART® protocol	Screw connection
with HART® protocol	Spring-cage conn.
	Screw connection
	Spring-cage conn.

Type	Order No.	Pcs. / Pkt.
MINI MCR-SL-RPSS-I-I ¹⁾	2864079	1
MINI MCR-SL-RPSS-I-I-SP ¹⁾	2810230	1
MINI MCR-SL-RPS-I-I ¹⁾	2864422	1
MINI MCR-SL-RPS-I-I-SP ¹⁾	2864752	1

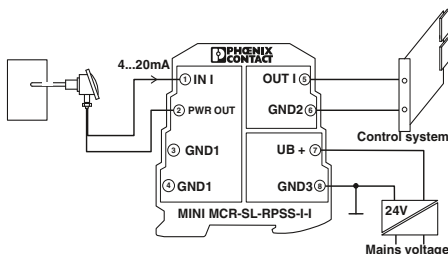

Repeater power supply operation with a passive sensor

Analog IN / Analog OUT passive isolators



Ex n



Either 1- or 2-channel

CE, RoHS, REACH
Ex: Ex n, Ex i, Ex s
Housing width 6.2 mm

- Highly compact 2-conductor passive isolators for electrical isolation and filtering of standard analog signals
- Input loop-supplied
- Does not require any additional auxiliary voltage
- 2 channels in conj. with a design width of just 6.2 mm
- Voltage drop on isolating amplifier of just 1.7 V

Notes:

When using passive isolators, make sure that the current sourcing voltage of the measuring transducer U_B is sufficient to drive the maximum current of 20 mA via the passive isolator with a voltage drop $U_V = 1.7 \text{ V}$ and load R_B .

This means:
 $U_B \geq U_E = 1.7 \text{ V} + 20 \text{ mA} \times R_B$

Information on components for power bridging, system cabling, and marking can be found in the INTERFACE catalog or at www.phoenixcontact.net/products

Input data

Input signal
Voltage drop
Response current
Maximum input current / overload
Maximum input voltage

Output data

Output signal
Load R_B
Ripple

General data

Maximum transmission error
Additional error per 100 Ω load
Temperature coefficient
Limit frequency (3 dB)
Step response (10 - 90%)
Electrical isolation
Test voltage input/output
Degree of protection
Ambient temperature (operation)
Mounting
Housing material
Dimensions W / H / D
Screw connection solid / stranded / AWG
Spring-cage connection (solid/stranded/AWG)
Conformance / approvals
Conformance
ATEX
UL, USA / Canada
GL

Technical data

0 ... 20 mA / 4 ... 20 mA
1.7 V (at I = 20 mA)
Approx. 190 μA
40 mA
18 V
0 ... 20 mA / 4 ... 20 mA
< 600 Ω (at I = 20 mA output signal)
< 10 mV_{rms} (at 600 Ω)
 $\leq 0.1\%$ (of final value)
0.03% (of measured value / 100 Ω load)
 $\leq 0.002\%/K$ (of measured value / 100 Ω load)
75 Hz
5 ms (At 600 Ω load)
Basic insulation according to EN 61010
1.5 kV (50 Hz, 1 min.)
IP20
-20°C ... 65°C
Any
PBT
6.2 / 93.1 / 102.5 mm
0.2 ... 2.5 mm² / 0.2 ... 2.5 mm² / 26 - 12
0.2 ... 2.5 mm² / 0.2 ... 2.5 mm² / 24 - 12
CE-compliant
Ex II 3 G Ex nA II T6 X
UL 508 Recognized
Class I, Div. 2, Groups A, B, C, D
GL EMC 2 D

Description

MCR passive isolator, for electrical isolation of current signals without auxiliary power
two-channel Screw connection
two-channel Spring-cage conn.
single-channel Screw connection
single-channel Spring-cage conn.

Ordering data

Type	Order No.	Pcs. / Pkt.
MINI MCR-SL-2CP-I-I	2864655	1
MINI MCR-SL-2CP-I-I-SP	2864781	1
MINI MCR-SL-1CP-I-I	2864419	1
MINI MCR-SL-1CP-I-I-SP	2864749	1

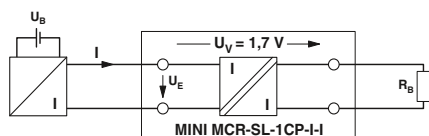

Analog IN/Analog OUT
loop-powered isolator



**Configurable,
up to 74 signal combinations,
loop-powered**

Applied for:
cUL / UL
Housing width 6.2 mm

Technical data

Input data	U input	I input
Input signal (configurable using the DIP switch)	2 ... 10 V, additional areas can be configured, see table	
Maximum input signal	< 40 V	< 50 mA (Dielectric strength up to 30 V)
Input resistance	Approx. 100 kΩ (At ≤ 1 V, otherwise approximately 1 MΩ)	≤ 50 Ω
Output data		
Output signal	4 ... 20 mA	
Maximum output signal	35 mA	
Load R _B	((U _B - 8 V) / 22 mA)	
Ripple	< 20 mV _{PP} (at 500 Ω)	
General data		
Supply voltage U _B	8 V DC ... 30 V DC	
Current consumption	< 3.5 mA (without signal current)	
Power consumption	28 mW (without signal)	
Maximum transmission error	< 0.1% (of final value)	
Temperature coefficient	0.01%/K, typ. 0.005%/K	
ZERO / SPAN adjustment	±2% / ±2%	
Limit frequency (3 dB)	Approx. 30 Hz	
Step response (10 - 90%)	Approx. 16 ms	
Electrical isolation	Basic insulation according to EN 61010	
Test voltage input/output	1.5 kV (50 Hz, 1 min.)	
Degree of protection	IP20	
Ambient temperature (operation)	-25°C ... 70°C	
Mounting	Any	
Housing material	PBT	
Dimensions W / H / D	6.2 / 93.1 / 102.5 mm	
Screw connection solid / stranded / AWG	0.2 ... 2.5 mm ² / 0.2 ... 2.5 mm ² / 26 - 12	
Spring-cage connection (solid/stranded/AWG)	0.2 ... 2.5 mm ² / 0.2 ... 2.5 mm ² / 24 - 12	
Conformance / approvals		
Conformance	CE-compliant	
ATEX	Ex II 3 G Ex nA IIC T4 Gc X	
UL, USA / Canada	UL 508 Recognized Class I, Div. 2, Groups A, B, C, D T5	

- Highly compact isolating amplifier for electrical isolation, conversion, and filtering of standard analog signals
- Supplied by an output loop
- Does not require any additional auxiliary voltage
- Up to 74 signal combinations can be configured using DIP switches
- Voltage input from mV voltages right up to 30 volts
- Current input from 2 mA right up to 40 mA
- 2-way isolation
- Standard configuration:
Input 2...10 V, output 4...20 mA

Notes:
Other input signals that have not been listed can be provided on request.
Information on components for power bridging, system cabling, and marking can be found in the INTERFACE catalog or at www.phoenixcontact.net/products
1) EMC: Class A product, see page 571

Ordering data

Description	Type	Order No.	Pcs. / Pkt.	
MCR loop-powered isolator	Screw connection	MINI MCR-SL-UI-I-LP-NC¹⁾	2902829	1
	Spring-cage conn.	MINI MCR-SL-UI-I-LP-SP-NC¹⁾	2902830	1

Possible input signal ranges (configurable via DIP switch)

0...40 mA	0...30 V	0...10 V	2...10 V	0...1000 mV	±30 V	±10 V	±1000 mV	
0...30 mA	0...25 V	0...7.5 V		0...750 mV	±25 V	±7.5 V	±750 mV	
0...20 mA	4...20 mA	0...20 V	0...5 V	1...5 V	0...500 mV	±20 V	±5 V	±500 mV
0...12 mA		0...15 V	0...3 V		0...300 mV	±15 V	±3 V	±300 mV
0...10 mA	2...10 mA	0...12.5 V	0...2.5 V		0...250 mV	±12.5 V	±2.5 V	±250 mV
0...8 mA		0...12 V	0...2 V		0...200 mV	±12 V	±2 V	±200 mV
0...7.5 mA			0...1.5 V		0...150 mV		±1.5 V	±150 mV
0...6 mA			0...1.25 V		0...125 mV		±1.25 V	±125 mV
0...5 mA	1...5 mA		0...1.2 V		0...120 mV		±1.2 V	±120 mV
0...4 mA					0...100 mV			±100 mV
0...3 mA					0...75 mV			±75 mV
0...2.5 mA					0...60 mV			±60 mV
0...2 mA					0...50 mV			±50 mV

Temperature
Temperature transducers
for resistance thermometers

N



Universal measuring transducer for resistance thermometers

Housing width 6.2 mm

Technical data

Input data
Input signal (can be configured using DIP switches)
Temperature range
Measuring range span
Linear resistance measuring range
Output data
Output signal
Maximum output signal
Load R_B
Ripple
General data
Supply voltage U_B
Current consumption
Power consumption
Transmission error
Temperature coefficient
Step response (0 - 99%)
Electrical isolation
Test voltage, input/output/supply
Ambient temperature (operation)
Housing material
Dimensions W / H / D
Screw connection solid / stranded / AWG
Spring-cage connection (solid/stranded/AWG)
Conformance / approvals
Conformance
ATEX
UL, USA / Canada
GL

Pt, Ni, Cu sensors : 2, 3, 4-conductor	
-200°C ... 850°C (Range depending on the sensor type)	
min. 50 K	
0 Ω ... 4000 Ω (Minimum measuring span: 10% of the selected measuring range)	
U output	I output
0 ... 5 V / 1 ... 5 V	0 ... 20 mA / 4 ... 20 mA
0 ... 10 V / 10 ... 0 V	20 ... 0 mA / 20 ... 4 mA
Approx. 12.3 V	24.6 mA
10 kΩ	500 Ω (at 20 mA)
< 20 mV _{pp}	< 20 mV _{pp} (at 500 Ω)
9.6 V DC ... 30 V DC	
< 27 mA (at 24 V DC)	
≤ 700 mW (at $I_{OUT} = 20$ mA, 9.6 V DC, load 500 Ω)	
0.1% * 350 K / set measuring range; 0.1% > 350 K (Pt/Ni) 0.3% * 200 K / set measuring range; 0.3% > 200 K (Cu)	
0.01%/K	
Typ. 200 ms (2-conductor)	
Typ. 500 ms (3-conductor)	
Typ. 500 ms (4-conductor)	
Basic insulation according to EN 61010	
1.5 kV (50 Hz, 1 min.)	
-20°C ... 65°C	
PBT	
6.2 / 93.1 / 102.5 mm	
0.2 ... 2.5 mm ² / 0.2 ... 2.5 mm ² / 26 - 12	
0.2 ... 2.5 mm ² / 0.2 ... 2.5 mm ² / 24 - 12	
CE-compliant	
Ex II 3 G Ex nA IIC T4 Gc X	
UL 508 Recognized applied for Class I, Div. 2, Groups A, B, C, D T5 applied for GL applied for	

- Universal temperature transducer for electrical isolation, conversion, amplification, and filtering of resistance thermometers and remote resistance-type sensors
- High level of accuracy over the entire measuring range
- For 2-, 3- or 4-conductor sensors according to IEC 751, JIS, GOST
- Configurable via DIP switches and software
- Software available free of charge on the Internet
- Power supply possible through the foot element (T-Connector)
- Supports fault monitoring
- Standard configuration: Pt 100 sensor IEC 751; 3-conductor; -50 ... 150°C; 4 ... 20 mA output; error evaluation according to NE43 (downscale); fault monitoring contact responds on any error

Notes:
The configuration software can be downloaded from the Internet: www.phoenixcontact.net/products
For information on the programming adapter, refer to page 119
Information about power bridging, system cabling, and marking components can be found starting at page 88
1) EMC: Class A product, see page 571

Description	
Temperature transducers for resistance thermometers	
Standard configuration	Screw connection
Standard configuration	Spring-cage conn.

Programming adapter for configuring modules with S-PORT interface

Ordering data		
Type	Order No.	Pcs. / Pkt.
MINI MCR-RTD-UI-NC ¹⁾	2902849	1
MINI MCR-RTD-UI-SP-NC ¹⁾	2902850	1

Accessories		
IFS-USB-PROG-ADAPTER ¹⁾	2811271	1

Sensor type	Standard	Measuring range	Smallest measuring range span
Pt100	IEC 751 = GOST 6651-2009 ($\alpha = 0.00385$)	-200°C ... +850°C	50 K
Pt200	IEC 751 = GOST 6651-2009 ($\alpha = 0.00385$)	-200°C ... +850°C	50 K
Pt500	IEC 751 = GOST 6651-2009 ($\alpha = 0.00385$)	-200°C ... +850°C	50 K
Pt1000	IEC 751 = GOST 6651-2009 ($\alpha = 0.00385$)	-200°C ... +850°C	50 K
Pt100	GOST 6651-2009 ($\alpha = 0.00391$)	-200°C ... +850°C	50 K
Pt1000	GOST 6651-2009 ($\alpha = 0.00391$)	-200°C ... +850°C	50 K
Pt100	JIS C1604-1997	-200°C ... +850°C	50 K
Pt1000	JIS C1604-1997	-200°C ... +850°C	50 K
Ni100	DIN 43760	-60°C ... +250°C	50 K
Ni1000	DIN 43760	-60°C ... +250°C	50 K
Cu50	GOST 6651-2009 ($\alpha = 1.428$)	-180°C ... +200°C	50 K
Cu100	GOST 6651-2009 ($\alpha = 1.428$)	-180°C ... +200°C	50 K
Cu53	GOST 6651-2009 ($\alpha = 1.426$)	-50°C ... +180°C	50 K

Temperature

Temperature transducer for Pt 100

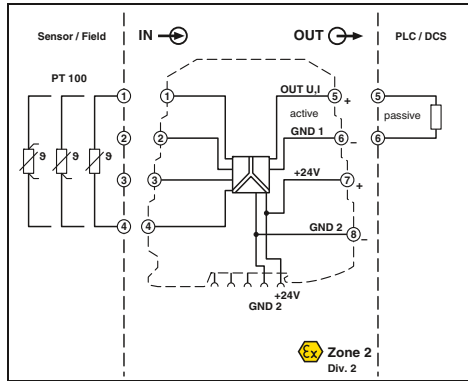

Configurable, for a temperature measuring range of -50°C ... +200°C



Housing width 6.2 mm

Technical data

Pt 100 (IEC 60751/EN 60751) : 2, 3, 4-conductor	
-50°C ... 200°C (configurable)	
min. 50 K	
U output	I output
0 ... 5 V / 1 ... 5 V	0 ... 20 mA / 4 ... 20 mA
0 ... 10 V / 10 ... 0 V	20 ... 0 mA / 20 ... 4 mA
Approx. 12.5 V	23 mA
> 10 kΩ	< 500 Ω (at 20 mA)
< 20 mV _{pp} (at 10 kΩ)	< 20 mV _{pp} (at 500 Ω)

19.2 V DC ... 30 V DC
< 21 mA (at 24 V DC)
< 500 mW
≤ 0.25% ; ((50 K / Δ Temp) + 0.05)%
< 0.02%/K
< 200 ms
Basic insulation according to EN 61010
1.5 kV (50 Hz, 1 min.)
-20°C ... 65°C
PBT
6.2 / 93.1 / 102.5 mm
0.2 ... 2.5 mm ² / 0.2 ... 2.5 mm ² / 26 - 12
0.2 ... 2.5 mm ² / 0.2 ... 2.5 mm ² / 24 - 12

CE-compliant
 Ex II 3 G Ex nA IIC T4 Gc X
 UL 508 Recognized
 Class I, Div. 2, Groups A, B, C, D T5
 GL EMC 2 D

Ordering data

Type	Order No.	Pcs. / Pkt.
MINI MCR-SL-PT100-UI-200	2864309	1
MINI MCR-SL-PT100-UI-200-SP ¹⁾	2864192	1
MINI MCR-SL-PT100-UI-200-NC ¹⁾	2864370	1
MINI MCR-SL-PT100-UI-200-SP-NC ¹⁾	2864202	1

- Highly compact temperature transducer for electrical isolation, conversion, amplification, and filtering of Pt 100 signals to create standard signals
- Optimized temperature measuring range of -50°C to +200°C for increased accuracy
- For 2-, 3- or 4-conductor Pt 100 sensors according to IEC 60751
- Input and output signals can be configured via DIP switches
- 3-way isolation
- Error signaling via diagnostic LED and analog signal
- Power supply possible through the foot element (T-Connector)

Notes:

To order a product with an order configuration, please enter the desired configuration by referring to the order key; see below.

Information about power bridging, system cabling, and marking components can be found starting at page 88

1) EMC: Class A product, see page 571

Input data

Input signal (can be configured using DIP switches)
 Temperature range
 Measuring range span

Output data

Output signal

Maximum output signal
 Load R_B
 Ripple

General data

Supply voltage U_B
 Current consumption
 Power consumption
 Transmission error for the full/set measurement range
 Temperature coefficient
 Step response (0 - 99%)
 Electrical isolation
 Test voltage, input/output/supply
 Ambient temperature (operation)
 Housing material
 Dimensions W / H / D
 Screw connection solid / stranded / AWG
 Spring-cage connection (solid/stranded/AWG)

Conformance / approvals

Conformance
 ATEX
 UL, USA / Canada

GL

Description

MCR temperature measuring transducer, for Pt 100 temperature sensors

Order configuration	Screw connection
Order configuration	Spring-cage conn.
Unconfigured	Screw connection
Unconfigured	Spring-cage conn.

Order key for MINI MCR-SL-PT100-UI-200 (standard configuration entered as an example)

Order No.	Connection technology	Measuring range [°C] Start End	Output	Failure information ¹⁾	Factory calibration certificate (FCC)
2864309	3	0 100	OUT01	A	NONE
2864309 ≙ ...-PT100-UI-200	2 ≙ 2-conductor 3 ≙ 3-conductor	0 -5 -10 -15	OUT01 ≙ 0...20 mA OUT02 ≙ 4...20 mA OUT03 ≙ 0...10 V OUT05 ≙ 0...5 V	A B C D	NONE ≙ without FCC YES ≙ with FCC (a fee is charged)
2864192 ≙ ...-PT100-UI-200-SP	4 ≙ 4-conductor	-20 -30 -40 -50	OUT06 ≙ 1...5 V OUT07 ≙ 20...0 mA OUT08 ≙ 20...4 mA OUT09 ≙ 10...0 V		YESPLUS ≙ FCC with 5 measuring points (a fee is charged)

Failure information (depends on the output signal range):

	Overrange			Open circuit		
	0...20 mA	4...20 mA	0...10 V	0...20 mA	4...20 mA	0...10 V
A	20.5 mA	20.5 mA	10.25 V	21 mA	21 mA	10.5 V
B	20.5 mA	20.5 mA	10.25 V	21 mA	21 mA	10.5 V
C	20 mA	20 mA	10 V	21 mA	21 mA	10.5 V
D	20 mA	20 mA	10 V	0 mA	4 mA	0 V

	Underrange			Short circuit		
	0...20 mA	4...20 mA	0...10 V	0...20 mA	4...20 mA	0...10 V
A	0 mA	4 mA	0 V	0 mA	4 mA	0 V
B	0 mA	3.5 mA	0 V	0 mA	3 mA	0 V
C	0 mA	4 mA	0 V	21 mA	21 mA	10.5 V
D	0 mA	4 mA	0 V	0 mA	4 mA	0 V

¹⁾ For explanations, see adjacent text on the right; for further details, see data sheet: www.phoenixcontact.net/products

Temperature

Temperature transducer for Pt 100

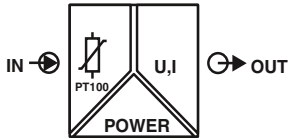

Ex n



Configurable, for a temperature measuring range of -150°C ... +850°C



Housing width 6.2 mm

- Highly compact temperature transducer for electrical isolation, conversion, amplification, and filtering of Pt 100 signals to create standard signals
- Temperature measuring range of -150°C to +850°C
- For 2-, 3- or 4-conductor Pt 100 sensors according to IEC 60751
- Input and output signals can be configured via DIP switches
- 3-way isolation
- Error signaling via diagnostic LED and analog signal
- Power supply possible through the foot element (T-Connector)

Notes:

To order a product with an order configuration, please enter the desired configuration by referring to the order key; see below.

Information about power bridging, system cabling, and marking components can be found starting at page 88

1) EMC: Class A product, see page 571

Input data	Input signal (can be configured using DIP switches) Temperature range Measuring range span
Output data	Output signal (configurable using the DIP switch)
General data	Maximum output signal Load R _B Ripple Supply voltage U _B Current consumption Power consumption Transmission error for the full/set measurement range
Temperature coefficient	< 0.02%/K
Step response (0 - 99%)	< 160 ms
Electrical isolation	Basic insulation according to EN 61010 1.5 kV (50 Hz, 1 min.) -20°C ... 65°C
Test voltage, input/output/supply	PBT
Ambient temperature (operation)	6.2 / 93.1 / 102.5 mm
Housing material	0.2 ... 2.5 mm ² / 0.2 ... 2.5 mm ² / 26 - 12
Dimensions W / H / D	0.2 ... 2.5 mm ² / 0.2 ... 2.5 mm ² / 24 - 12
Screw connection solid / stranded / AWG	
Spring-cage connection (solid/stranded/AWG)	
Conformance / approvals	CE-compliant Ex II 3 G Ex nA IIC T4 Gc X UL 508 Recognized Class I, Div. 2, Groups A, B, C, D T5 GL EMC 2 D
Conformance	
ATEX	
UL, USA / Canada	
GL	

Technical data

Pt 100 (IEC 60751/EN 60751) : 2, 3, 4-conductor	
-150°C ... 850°C (configurable)	
min. 50 K	
U output	I output
0 ... 5 V / 1 ... 5 V	0 ... 20 mA / 4 ... 20 mA
0 ... 10 V / 10 ... 0 V	20 ... 0 mA / 20 ... 4 mA
Approx. 12.5 V	23 mA
≥ 10 kΩ	< 500 Ω (at 20 mA)
< 20 mV _{pp} (at 10 kΩ)	< 20 mV _{pp} (at 500 Ω)

19.2 V DC ... 30 V DC
< 21 mA (at 24 V DC)
< 500 mW
≤ 0.2% ; ((100 K / set measurement range [K]) + 0.1%)

< 0.02%/K
< 160 ms
Basic insulation according to EN 61010
1.5 kV (50 Hz, 1 min.)
-20°C ... 65°C
PBT
6.2 / 93.1 / 102.5 mm
0.2 ... 2.5 mm ² / 0.2 ... 2.5 mm ² / 26 - 12
0.2 ... 2.5 mm ² / 0.2 ... 2.5 mm ² / 24 - 12

CE-compliant
Ex II 3 G Ex nA IIC T4 Gc X
UL 508 Recognized
Class I, Div. 2, Groups A, B, C, D T5
GL EMC 2 D

Ordering data

Description	Order configuration	Order configuration	Unconfigured	Unconfigured
MCR temperature measuring transducer, for Pt 100 temperature sensors	Screw connection	Spring-cage conn.	Screw connection	Spring-cage conn.
	MINI MCR-SL-PT100-UI ¹⁾	MINI MCR-SL-PT100-UI-SP	MINI MCR-SL-PT100-UI-NC ¹⁾	MINI MCR-SL-PT100-UI-SP-NC ¹⁾

Type	Order No.	Pcs. / Pkt.
MINI MCR-SL-PT100-UI ¹⁾	2864435	1
MINI MCR-SL-PT100-UI-SP	2864736	1
MINI MCR-SL-PT100-UI-NC ¹⁾	2864273	1
MINI MCR-SL-PT100-UI-SP-NC ¹⁾	2864286	1

Order key for MINI MCR-SL-PT100-UI (standard configuration entered as an example)

Order No.	Connection technology	Measuring range [°C]	Output	Failure information ¹⁾	Factory calibration certificate (FCC)
2864435	3	0 ... 100	OUT01	A	NONE
2864435 ≙ ...PT100-UI	2 ≙ 2-conductor 3 ≙ 3-conductor	0 ... -10 -20 ... -30 0...100 (5 K)	OUT01 ≙ 0...20 mA OUT02 ≙ 4...20 mA OUT03 ≙ 0...10 V OUT05 ≙ 0...5 V	A B C D	NONE ≙ without FCC YES ≙ with FCC (a fee is charged)
2864736 ≙ ...PT100-UI-SP	4 ≙ 4-conductor	-40 ... -50 -50 ... -100 -150	OUT06 ≙ 1...5 V OUT07 ≙ 20...0 mA OUT08 ≙ 20...4 mA OUT09 ≙ 10...0 V		YESPLUS ≙ FCC with 5 measuring points (a fee is charged)

Failure information (depends on the output signal range):

	Overrange			Open circuit		
	0...20 mA	4...20 mA	0...10 V	0...20 mA	4...20 mA	0...10 V
A	20.5 mA	20.5 mA	10.25 V	21 mA	21 mA	10.5 V
B	20.5 mA	20.5 mA	10.25 V	21 mA	21 mA	10.5 V
C	20 mA	20 mA	10 V	21 mA	21 mA	10.5 V
D	20 mA	20 mA	10 V	0 mA	4 mA	0 V

	Underrange			Short circuit		
	0...20 mA	4...20 mA	0...10 V	0...20 mA	4...20 mA	0...10 V
A	0 mA	4 mA	0 V	0 mA	4 mA	0 V
B	0 mA	3.5 mA	0 V	0 mA	3 mA	0 V
C	0 mA	4 mA	0 V	21 mA	21 mA	10.5 V
D	0 mA	4 mA	0 V	0 mA	4 mA	0 V

¹⁾ For explanations, see adjacent text on the right; for further details, see data sheet: www.phoenixcontact.net/products

Temperature

Temperature transducer for Pt 100

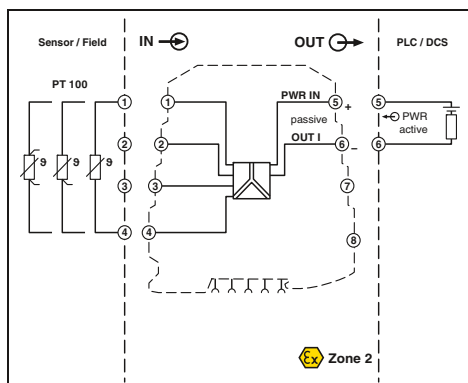
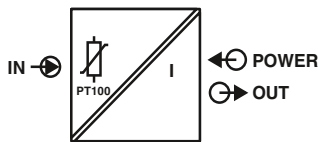

Ex n



Configurable, for a temperature measuring range of -150°C ... +300°C, loop-powered



Housing width 6.2 mm

Technical data

Pt 100 (IEC 60751/EN 60751) : 2, 3, 4-conductor
 -150°C ... 300°C (configurable)
 min. 50 K

4 ... 20 mA / 20 ... 4 mA
 23 mA
 ((U_{supply} - 12 V) / 22 mA)
 < 20 mV_{pp} (at 500 Ω)

12 V DC ... 30 V DC
 < 3.5 mA (without signal current)
 < 42 mW (without signal current)
 ≤ 0.25% ; ((90 K / set measuring range [K]) + 0.05%)

< 0.02%/K
 < 200 ms
 Basic insulation according to EN 61010
 1.5 kV (50 Hz, 1 min.)
 IP20
 -20°C ... 65°C
 Any
 PBT
 6.2 / 93.1 / 102.5 mm
 0.2 ... 2.5 mm² / 0.2 ... 2.5 mm² / 26 - 12
 0.2 ... 2.5 mm² / 0.2 ... 2.5 mm² / 24 - 12

CE-compliant
 Ex II 3 G Ex nA IIC T4 Gc X
 UL 508 Recognized
 Class I, Div. 2, Groups A, B, C, D T5 applied for

Ordering data

Input data
 Input signal (can be configured using DIP switches)
 Temperature range
 Measuring range span

Output data
 Output signal
 Maximum output signal
 Load R_B
 Ripple

General data
 Supply voltage U_B
 Current consumption
 Power consumption
 Transmission error for the full/set measurement range

Temperature coefficient
 Step response (0 - 99%)
 Electrical isolation
 Test voltage, input/output/supply
 Degree of protection
 Ambient temperature (operation)
 Mounting
 Housing material
 Dimensions W / H / D
 Screw connection solid / stranded / AWG
 Spring-cage connection (solid/stranded/AWG)
 Conformance / approvals

Conformance
 ATEX
 UL, USA / Canada

Description	Type	Order No.	Pcs. / Pkt.
MCR temperature measuring transducer , for Pt 100 temperature sensors, loop-powered			
Order configuration Screw connection	MINI MCR-SL-PT100-LP	2810298	1
Order configuration Spring-cage conn.	MINI MCR-SL-PT100-LP-SP	2810382	1
Unconfigured Screw connection	MINI MCR-SL-PT100-LP-NC¹⁾	2810308	1
Unconfigured Spring-cage conn.	MINI MCR-SL-PT100-LP-NC-SP¹⁾	2810395	1

Notes:
 To order a product with an order configuration, please enter the desired configuration by referring to the order key; see below.
 Information about power bridging, system cabling, and marking components can be found starting at page 88
 1) EMC: Class A product, see page 571

Order key for MINI MCR-SL-PT100-LP (standard configuration entered as an example)

Order No.	Connection technology	Measuring range [°C] Start End	Output	Failure information ¹⁾	Factory calibration certificate (FCC)
2810298	3	0 100	OUT02	1	NONE
2810298 ≙ ...-PT100-LP	2 ≙ 2-conductor 3 ≙ 3-conductor	0 -10 -20 -30 -40 -50 -100 -150	Range (increment) OUT02 ≙ 4...20 mA OUT08 ≙ 20...4 mA	1 2 3 4	NONE ≙ without FCC YES ≙ with FCC (a fee is charged)
2810382 ≙ ...-PT100-LP-SP	4 ≙ 4-conductor	0...300 (5 K)			YESPLUS ≙ FCC with 5 measuring points (a fee is charged)

	Failure information	
	Overrange	Open circuit
1	-	Start of range
2	21.5 mA	21.5 mA
3	3.5 mA	3.5 mA
4	21.5 mA	21.5 mA
	Failure information	
	Underrange	Short circuit
1	-	Start of range
2	21.5 mA	21.5 mA
3	3.5 mA	3.5 mA
4	3.5 mA	3.5 mA

¹⁾ For explanations, see adjacent text on the right; for further details, see data sheet: www.phoenixcontact.net/products

Temperature Temperature transducers for thermocouples

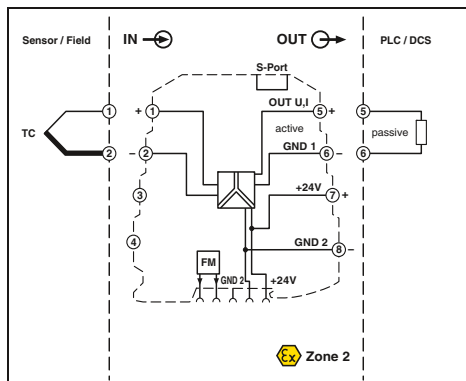
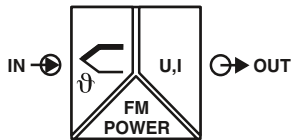

Universal measuring transducer for thermocouples

Housing width 6.2 mm

Technical data

B, E, J, K, N, R, S, T, L, U, A-1, A-2, A-3, M, L
-250°C ... 2500°C (Range depending on the sensor type)

min. 50 K	
U output	1 output
0 ... 5 V / 1 ... 5 V	0 ... 20 mA / 4 ... 20 mA
0 ... 10 V / 10 ... 0 V	20 ... 0 mA / 20 ... 4 mA
Approx. 12.3 V	24.6 mA

≥ 10 kΩ	< 500 Ω (at 20 mA)
< 20 mV _{PP}	< 20 mV _{PP} (at 500 Ω)

9.6 V DC ... 30 V DC
< 27 mA (at 24 V DC)
≤ 700 mW (at I_{OUT} = 20 mA, 9.6 V DC, load 500 Ω)

0.1% * 600 K / set measuring range; 0.1% > 600 K (E, J, K, N, T, L, U, M, Gost, L Gost) 0.2% * 600 K / set measuring range; 0.2% > 600 K (B, R, S, A1, A2, A3)

< 3 K (typ. < 2 K)
≤ 0.01%/K
Typ. 400 ms
Basic insulation according to EN 61010
1.5 kV (50 Hz, 1 min.)
-20°C ... 65°C
PBT
6.2 / 93.1 / 102.5 mm
0.2 ... 2.5 mm² / 0.2 ... 2.5 mm² / 26 - 12

CE-compliant
Ex II 3 G Ex nA IIC T4 Gc X
UL 508 Recognized applied for
Class I, Div. 2, Groups A, B, C, D T5 applied for
GL applied for

Ordering data

Type	Order No.	Pcs. / Pkt.
MINI MCR-TC-UI-NC ¹⁾	2902851	1

Accessories

IFS-USB-PROG-ADAPTER ¹⁾	2811271	1
------------------------------------	---------	---

Highly compact temperature transducer for electrical isolation, conversion, amplification, and filtering of thermocouple signals.

- For thermocouples according to IEC 584 and GOST
- Internal cold junction compensation
- Configurable via DIP switches and software
- Software available free of charge on the Internet
- Power supply possible through the foot element (T-Connector)
- Supports fault monitoring
- Standard configuration: TC sensor type J IEC 584 TC; cold junction compensation “ON”; -200 ... 1200°C; 4 ... 20 mA output; error evaluation according to NE43 (downscale); fault monitoring contact responds on any error.

Notes:

For information on the programming adapter, refer to page 119

The configuration software can be downloaded from the Internet: www.phoenixcontact.net/products

Information about power bridging, system cabling, and marking components can be found starting at page 88

1) EMC: Class A product, see page 571

Input data

Input signal (can be configured using DIP switches)
Temperature range

Measuring range span

Output data
Output signal (configurable using the DIP switch)

Maximum output signal

No-load voltage
Short-circuit current
Load R_B
Ripple

General data

Supply voltage U_B
Current consumption
Power consumption

Transmission error

Cold junction errors
Temperature coefficient
Step response (0 - 99%)
Electrical isolation
Test voltage, input/output/supply
Ambient temperature (operation)
Housing material
Dimensions W / H / D
Screw connection solid / stranded / AWG

Conformance / approvals

Conformance
ATEX
UL, USA / Canada

GL

Description

Universal temperature transducer for thermocouples

Standard configuration Screw connection

Programming adapter for configuring modules with S-PORT interface

Sensor type	Standard	Measuring range
B	IEC 584-1	+500°C ... +1820°C
E	IEC 584-1	-230°C ... +1000°C
J	IEC 584-1	-210°C ... +1200°C
K	IEC 584-1	-250°C ... +1372°C
N	IEC 584-1	-200°C ... +1300°C
R	IEC 584-1	-50°C ... +1768°C
S	IEC 584-1	-50°C ... +1768°C
T	IEC 584-1	-200°C ... +400°C

Sensor type	Standard	Measuring range
L	DIN 43710	-200°C ... +900°C
U	DIN 43710	-200°C ... +600°C
A-1	GOST 8.585	0°C ... +2500°C
A-2	GOST 8.585	0°C ... +1800°C
A-3	GOST 8.585	0°C ... +1800°C
M	GOST 8.585	-200°C ... +100°C
L	GOST 8.585	-200°C ... +800°C
Customer-specific characteristic curves		

Temperature
Temperature transducer for
J- and K-type thermocouples

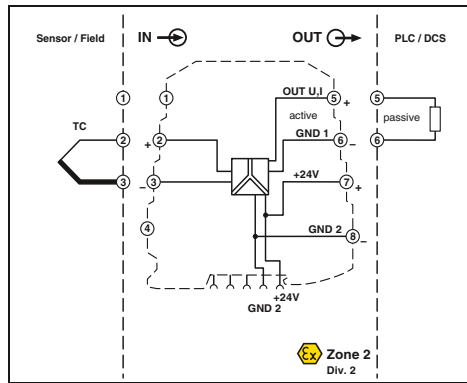
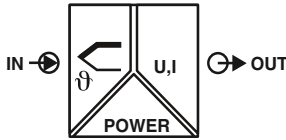

Configurable, for a temperature measuring range of -150°C ... +1350°C



Housing width 6.2 mm

- Highly compact temperature transducer for electrical isolation, conversion, amplification, and filtering of thermocouple signals to create standard signals
- Temperature measuring range of -150°C to +1350°C
- For J and K thermocouples according to IEC 584-1
- Internal cold junction compensation
- Input and output signals can be configured via DIP switches
- 3-way isolation
- Error signaling via diagnostic LED and analog signal
- Power supply possible through the foot element (T-Connector)

Notes:
 To order a product with an order configuration, please enter the desired configuration by referring to the order key; see below.
 Information about power bridging, system cabling, and marking components can be found starting at page 88
 1) EMC: Class A product, see page 571

Input data	Input signal (can be configured using DIP switches)
Temperature range	
Measuring range span	
Output data	Output signal (configurable using the DIP switch)
Maximum output signal	No-load voltage Short-circuit current Load R _B Ripple
General data	Supply voltage U _B Current consumption Power consumption Transmission error for the full/set measurement range
Cold junction errors	Temperature coefficient Step response (0 - 99%) Electrical isolation
Test voltage, input/output/supply	Ambient temperature (operation) Housing material Dimensions W / H / D Screw connection solid / stranded / AWG
Conformance / approvals	Conformance ATEX UL, USA / Canada GL

Technical data	
Thermocouples type J, K (IEC 584-1)	
Typ J: -150°C ... 1200°C (configurable) Typ K: -150°C ... 1350°C min. 50 K	
U output	I output
0 ... 5 V / 1 ... 5 V 0 ... 10 V / 10 ... 0 V Approx. 12.5 V	0 ... 20 mA / 4 ... 20 mA 20 ... 0 mA / 20 ... 4 mA 23 mA Approx. 12.5 V
Approx. 10 mA ≥ 10 kΩ < 20 mV _{pp} (at 10 kΩ)	Approx. 12.5 V < 500 Ω (at 20 mA) < 20 mV _{pp} (at 500 Ω)
19.2 V DC ... 30 V DC < 25 mA (at 24 V DC) < 500 mW ≤ 0.2% ; ((150 K / set measurement range [K]) + 0.1%)	
< 3 K (typ. < 2 K) < 0.02%/K < 30 ms Basic insulation according to EN 61010 1.5 kV (50 Hz, 1 min.) -20°C ... 65°C PBT 6.2 / 93.1 / 102.5 mm 0.2 ... 2.5 mm ² / 0.2 ... 2.5 mm ² / 26 - 12	
CE-compliant Ex II 3 G Ex nA IIC T4 Gc X UL 508 Recognized Class I, Div. 2, Groups A, B, C, D T5 GL EMC 2 D	

Description	MCR temperature measuring transducer, for thermocouples	
Order configuration	Screw connection	MINI MCR-SL-TC-UI¹⁾
Unconfigured	Screw connection	MINI MCR-SL-TC-UI-NC¹⁾

Ordering data		
Type	Order No.	Pcs. / Pkt.
MINI MCR-SL-TC-UI¹⁾	2864448	1
MINI MCR-SL-TC-UI-NC¹⁾	2864299	1

Order key for MINI MCR-SL-TC-UI (standard configuration entered as an example)

Order No.	Sensor type	Measuring range [°C]	Output	Failure information ¹⁾	Factory calibration certificate (FCC)
2864448	J	0	1000	OUT01	A
	J ≙ Type J	0	Range (increment)	OUT01 ≙ 0...20 mA	A NONE ≙ without FCC
	K ≙ Type K	-10		OUT02 ≙ 4...20 mA	B YES ≙ with FCC (a fee is charged)
		-20		OUT03 ≙ 0...10 V	C
		-30		OUT04 ≙ 0...5 V	D
		-40	0 ... 300 (10 K)	OUT05 ≙ 1...5 V	YESPLUS ≙ FCC with 5 measuring points (a fee is charged)
		-50	320 ... 700 (20 K)	OUT06 ≙ 20...0 mA	
		-100	750...1350 (50 K)	OUT07 ≙ 20...4 mA	
		-150		OUT08 ≙ 10...0 V	
				OUT09 ≙ 10...0 V	

Failure information (depends on the output signal range):					
Overrange		Open circuit			
0...20 mA	4...20 mA	0...10 V	0...20 mA	4...20 mA	0...10 V
A 20.5 mA	20.5 mA	10.25 V	21 mA	21 mA	10.5 V
B 20.5 mA	20.5 mA	10.25 V	21 mA	21 mA	10.5 V
C 20 mA	20 mA	10 V	21 mA	21 mA	10.5 V
D 20 mA	20 mA	10 V	0 mA	4 mA	0 V
Underrange					
0...20 mA	4...20 mA	0...10 V			
A 0 mA	4 mA	0 V			
B 0 mA	3.5 mA	0 V			
C 0 mA	4 mA	0 V			
D 0 mA	4 mA	0 V			

¹⁾ For explanations, see adjacent text on the right; for further details, see data sheet: www.phoenixcontact.net/products

Frequency
Frequency transducers
For up to 80 kHz

N

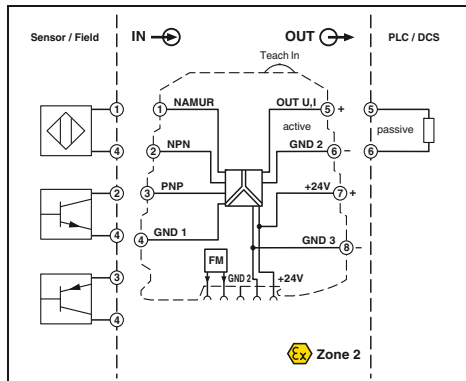
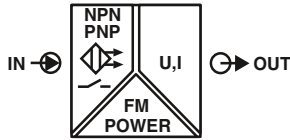

Frequency transducer for up to 80 kHz

Housing width 6.2 mm

Technical data

Configurable 3-way isolated frequency transducer.

- Suitable for the connection of NAMUR proximity sensors (IEC 60947-5-6 and EN 50227) as well as for sensors with NPN and PNP outputs that generate a frequency signal
- The device is configured via DIP switches
- Frequency range is freely adjustable via a press/slide button ("teach-in wheel")
- Supports fault monitoring
- Standard configuration: NAMUR sensor; mean-value generation "OFF"; 0.002 Hz ... 20 kHz frequency range; 4 ... 20 mA output; error evaluation NE43 (downscale); fault monitoring contact responds on any error

Notes:
Information about power bridging, system cabling, and marking components can be found starting at page 88

1) EMC: Class A product, see page 571

Input data	Input sources
Frequency measuring range	
Maximum input signal	
Output data	Output signal
Maximum output signal	
Load R_B	
Ripple	
General data	Supply voltage U_B Power consumption
Transmission error of the full measuring span	
Temperature coefficient	
Step response (0 - 99%)	
Electrical isolation	
Test voltage, input/output/supply	
Degree of protection	
Ambient temperature (operation)	
Mounting	
Housing material	
Dimensions W / H / D	
Screw connection solid / stranded / AWG	
Spring-cage connection (solid/stranded/AWG)	
Conformance / approvals	
Conformance	
ATEX	
UL, USA / Canada	
GL	

NPN/PNP transistor outputs NAMUR initiators Floating relay contact (dry contact) 0.002 Hz ... 20 kHz (DIP switch) 0.002 Hz ... 80 kHz (Teach-in wheel) 30 V (incl. DC voltage)	
U output	I output
0 ... 5 V / 1 ... 5 V	0 ... 20 mA / 4 ... 20 mA
0 ... 10 V / 10 ... 0 V	20 ... 0 mA / 20 ... 4 mA
Approx. 12.3 V	24.6 mA
$\geq 10 \text{ k}\Omega$	500 Ω (at 20 mA)
$< 20 \text{ mV}_{PP}$	$< 20 \text{ mV}_{PP}$ (at 500 Ω)
9.6 V DC ... 30 V DC $< 800 \text{ mW}$ (at $I_{OUT} = 20 \text{ mA}$, 9.6 V DC, load 500 Ω)	
0.1% 0.01%/K $< 35 \text{ ms}$ (At $f > 500 \text{ Hz}$) Basic insulation according to EN 61010 1.5 kV (50 Hz, 1 min.) IP20 -20°C ... 65°C Any PBT 6.2 / 93.1 / 102.5 mm 0.2 ... 2.5 mm ² / 0.2 ... 2.5 mm ² / 26 - 12 0.2 ... 2.5 mm ² / 0.2 ... 2.5 mm ² / 24 - 12	
CE-compliant Ex II 3 G Ex nA IIC T4 Gc X UL 508 Recognized applied for Class I, Div. 2, Groups A, B, C, D T5 applied for GL applied for	

Ordering data

Description	
MCR frequency transducers	
Standard configuration	Screw connection
Standard configuration	Spring-cage conn.

Type	Order No.	Pcs. / Pkt.
MINI MCR-SL-F-UI-NC¹⁾	2902832	1
MINI MCR-SL-F-UI-SP-NC¹⁾	2902833	1

Frequency
Analog-frequency transducer

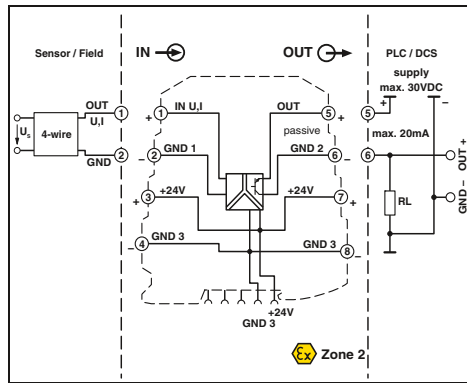
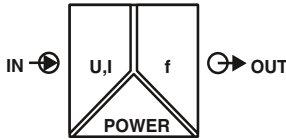

Configurable,
frequency and PWM output



Housing width 6.2 mm

- Highly compact analog-to-frequency transducer for electrical isolation, amplification, conversion, and filtering of standard signals to create frequencies or PWM signals
- Configurable interference filter
- Input and output signals can be configured via DIP switches
- 3-way isolation
- Error signaling via diagnostic LED and analog signal
- Power supply possible through the foot element (T-Connector)
- PWM output of 5 ... 95%

Notes:
Information about power bridging, system cabling, and marking components can be found starting at page 88
1) EMC: Class A product, see page 571

Input data	Input signal (configurable using the DIP switch)
Maximum input signal	
Input resistance	
Output data	Output signal (can be configured using DIP switches)
Minimum load	
Maximum load current	
Maximum switching voltage	
Overrange/underrange	
Protective circuit	
General data	
Supply voltage U_B	19.2 V DC ... 30 V DC
Nominal supply voltage	24 V DC
Current consumption	< 10 mA (at 24 V DC)
Power consumption	< 200 mW
Maximum transmission error	$\leq 0.1\%$ (> 7 kHz $\leq 0.2\%$)
Temperature coefficient	< 0.02%/K
Step response (0 - 99%)	< 15 ms (+ (1/f) smallest filter) < 1 s (+ (1/f) largest filter)
Electrical isolation	
Test voltage, input/output/supply	Basic insulation according to EN 61010 1.5 kV (50 Hz, 1 min.)
Degree of protection	IP20
Ambient temperature (operation)	-20°C ... 65°C
Mounting	Any
Housing material	PBT
Dimensions W / H / D	6.2 / 93.1 / 102.5 mm
Screw connection solid / stranded / AWG	0.2 ... 2.5 mm ² / 0.2 ... 2.5 mm ² / 26 - 12
Spring-cage connection (solid/stranded/AWG)	0.2 ... 2.5 mm ² / 0.2 ... 2.5 mm ² / 24 - 12
Conformance / approvals	
Conformance	CE-compliant
ATEX	Ex II 3 G Ex nA IIC T4 Gc X
UL, USA / Canada	UL 508 Recognized Class I, Div. 2, Groups A, B, C, D T5 applied for GL EMC 2 D
GL	

Technical data

U input	0 ... 5 V / 1 ... 5 V	I input	0 ... 20 mA / 4 ... 20 mA
	0 ... 10 V / 2 ... 10 V		0 ... 10 mA / 2 ... 10 mA -
	30 V DC		100 mA
	Approx. 110 kΩ		Approx. 50 Ω
Frequency output		PWM output	
	0 Hz ... 10 kHz / 0 Hz ... 5 kHz		7.8 kHz (10 bit) / 3.9 kHz (10 bit)
	0 Hz ... 2.5 kHz / 0 Hz ... 1 kHz		1.9 kHz (12 bit) / 977 Hz (12 bit)
	0 Hz ... 500 Hz / 0 Hz ... 250 Hz		488 Hz (14 bit) / 244 Hz (14 bit)
	0 Hz ... 100 Hz / 0 Hz ... 50 Hz		122 Hz (16 bit) / 61 Hz (16 bit)
	4 mA $\leq (U_L / R_L) \leq 20$ mA		12 mA $\leq (U_L / R_L) \leq 20$ mA
	20 mA		
	30 V		
	Can be set (via DIP switch)		
	Short-circuit protection, polarity reversal protection		

Ordering data	
Type	Order No. Pcs. / Pkt.
MINI MCR-SL-UI-F ¹⁾	2864082 1
MINI MCR-SL-UI-F-SP ¹⁾	2810243 1

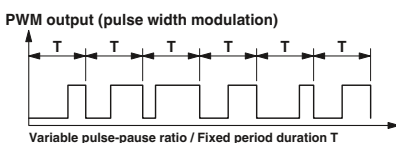
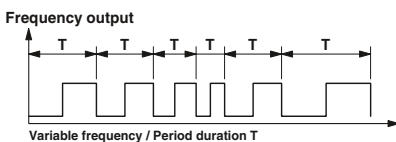

Description	Screw connection Spring-cage conn.
MCR frequency transducer	

Potentiometer
Potiposition transducer

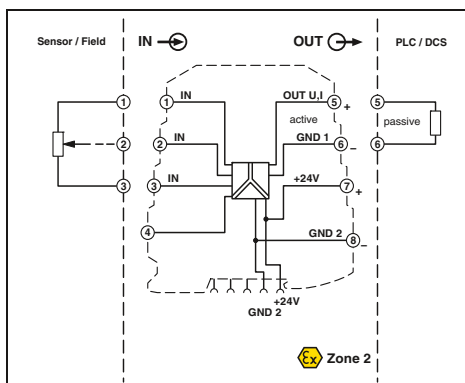
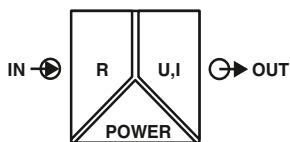

Ex n



Configurable,
automatic potentiometer detection



Housing width 6.2 mm

- Highly compact potiposition transducer for electrical isolation, conversion, amplification, and filtering of potentiometer signals to create standard signals
- Automatic potentiometer detection without manual adjustment
- For potentiometers from 100 Ω to 100 kΩ
- Configurable measuring range and output signals
- A potentiometer sub-range can be linearized via the “teach-in” switch on the device
- Input and output signals can be configured via DIP switches
- 3-way isolation
- Error signaling via diagnostic LED and analog signal
- Power supply possible through the foot element (T-Connector)

Notes:
Information about power bridging, system cabling, and marking components can be found starting at page 88
1) EMC: Class A product, see page 571

Input data	Potentiometer Reference voltage source
Output data	Output signal
Maximum output signal	No-load voltage Short-circuit current Load R_B Ripple Behavior in the event of a sensor error
General data	Supply voltage U_B Nominal supply voltage Current consumption Power consumption Maximum transmission error Temperature coefficient Step response (0 - 99%) Electrical isolation Test voltage, input/output/supply Degree of protection Ambient temperature (operation) Mounting Housing material Dimensions W / H / D Screw connection solid / stranded / AWG Spring-cage connection (solid/stranded/AWG)
Conformance / approvals	Conformance ATEX UL, USA / Canada
GL	

Technical data	
100 Ω ... 100 kΩ	
< 3.6 V	
U output	I output
0 ... 5 V / 1 ... 5 V	0 ... 20 mA / 4 ... 20 mA
0 ... 10 V / 10 ... 0 V	20 ... 0 mA / 20 ... 4 mA
12.5 V	23 mA
	Approx. 12.5 V
Approx. 10 mA	
> 10 kΩ	< 500 Ω (20 mA)
< 20 mV _{PP} (at 10 kΩ)	< 20 mV _{PP} (at 500 Ω)
0% ... 105% (configurable)	
19.2 V DC ... 30 V DC	
24 V DC	
< 25 mA (at 24 V DC)	
< 500 mW	
< 0.2%	
< 0.02%/K	
< 30 ms	
Basic insulation according to EN 61010	
1.5 kV (50 Hz, 1 min.)	
IP20	
-20°C ... 65°C	
Any	
PBT	
6.2 / 93.1 / 102.5 mm	
0.2 ... 2.5 mm ² / 0.2 ... 2.5 mm ² / 26 - 12	
0.2 ... 2.5 mm ² / 0.2 ... 2.5 mm ² / 24 - 12	
CE-compliant	
Ex II 3 G Ex nA IIC T4 Gc X	
UL 508 Recognized	
Class I, Div. 2, Groups A, B, C, D T5 applied for	
GL EMC 2 D	

Description	
MINI potiposition transducer	
	Screw connection
	Spring-cage conn.

Ordering data		
Type	Order No.	Pcs. / Pkt.
MINI MCR-SL-R-UI ¹⁾	2864095	1
MINI MCR-SL-R-UI-SP ¹⁾	2810256	1

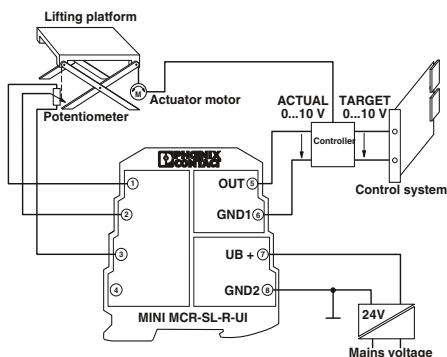

Height adjustment of a lifting platform with setpoint and actual value control

Limit values

Threshold value switch

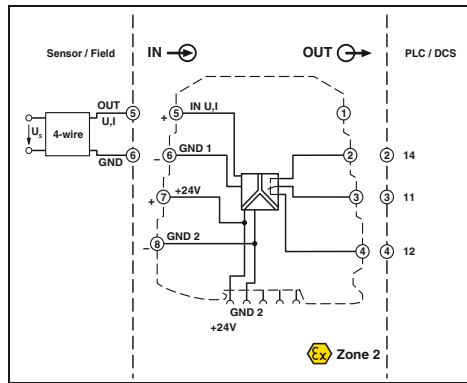
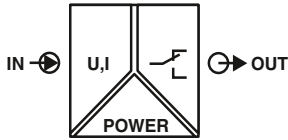

Ex n



Configurable, with relay PDT output



Housing width 6.2 mm

- Highly compact threshold value switch for switching analog limit values
- Input signal, hysteresis, and delay time can be configured via DIP switches
- Limit value can be freely adjusted via potentiometer on front
- 3-way isolation
- PDT relay at output
- Operating current/quiescent current switchover
- Status and error signaling via two diagnostic LEDs
- Power supply possible through the foot element (T-Connector)

Notes:
Information about power bridging, system cabling, and marking components can be found starting at page 88
1) EMC: Class A product, see page 571

Input data
Input signal (configurable using the DIP switch)
Maximum input signal
Input resistance
Specification of the switching point
Switching output
Relay output
Contact material
Max. switching voltage
Limiting continuous current
Hysteresis (configurable using the DIP switch)
Operating and closed circuit current behavior
Setting range of the response delay (configurable using the DIP switch)
General data
Supply voltage U_B
Nominal supply voltage
Current consumption
Power consumption
Linearity error
Temperature coefficient
Step response (0 - 99%)
Electrical isolation
Test voltage input/power supply
Degree of protection
Ambient temperature (operation)
Mounting
Housing material
Dimensions W / H / D
Screw connection solid / stranded / AWG
Spring-cage connection (solid/stranded/AWG)
Conformance / approvals
Conformance
ATEX
UL, USA / Canada
UL, USA
UL, Canada
GL

Technical data

U input	I input
0 ... 10 V	0 ... 20 mA
30 V	100 mA
> 100 kΩ	50 Ω
With 25-speed potentiometer	
1 PDT	
AgSnO ₂ , hard gold-plated	
250 V AC	
2 A	
(0.1%; 1%; 2.5%; 5%)	
Switchable using DIP switch	
0 s ... 10 s (0 s; 1 s; 2 s; 3 s; 4 s; 6 s; 8 s; 10 s)	
19.2 V DC ... 30 V DC	
24 V DC	
< 14 mA (at 24 V DC)	
< 330 mW (at 24 V DC)	
< 0.05% (of final value)	
< 0.02%/K	
< 35 ms	
Basic insulation according to EN 61010	
1.5 kV AC (50 Hz, 1 min.)	
IP20	
-20°C ... 65°C	
Any	
PBT	
6.2 / 93.1 / 102.5 mm	
0.2 ... 2.5 mm ² / 0.2 ... 2.5 mm ² / 26 - 12	
0.2 ... 2.5 mm ² / 0.2 ... 2.5 mm ² / 24 - 12	
CE-compliant	
Ex II 3 G Ex nA nC IIC T4 Gc X	
UL 508 Recognized	
Class I, Zone 2, AEx nC IIC T6	
Class I, Zone 2, Ex nC IIC T6	
GL EMC 2 D	

Ordering data

Description	Type	Order No.	Pcs. / Pkt.
MCR threshold value switch			
Screw connection	MINI MCR-SL-UI-REL ¹⁾	2864480	1
Spring-cage conn.	MINI MCR-SL-UI-REL-SP ¹⁾	2864493	1

Digital IN
NAMUR isolation amplifiers

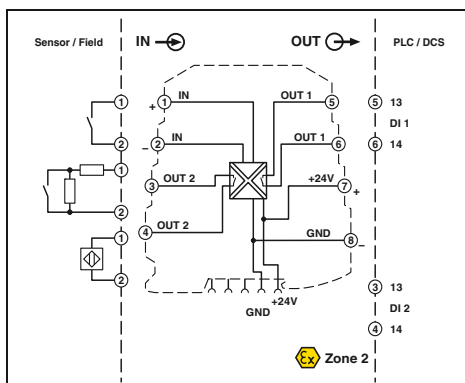
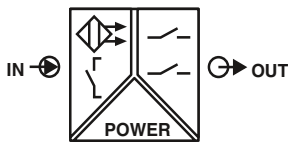

Ex n

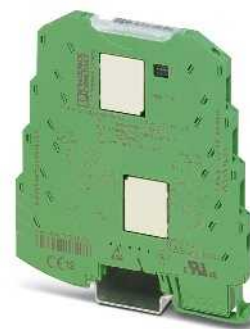

Configurable, for NAMUR sensors and floating contacts



Housing width 6.2 mm

- Highly compact isolation amplifier for electrical isolation, amplification, and duplication of proximity sensor signals
- For proximity sensors in accordance with IEC 60947-5-6 and EN 50227
- Floating contacts and contacts with resistance circuit can be connected
- Input and output signals can be configured via DIP switches
- N/O contacts at output
- Second output can be used as a doubler or error signaling output
- 3-way isolation
- Switchover between operating current and quiescent current (inverted switching behavior)
- Error signaling via diagnostic LED and analog signal
- Power supply possible through the foot element (T-Connector)

Notes:
Information about power bridging, system cabling, and marking components can be found starting at page 88
1) EMC: Class A product, see page 571

Input data	Input signal
Control circuit	No-load voltage Switching points (according to IEC 60947-5-6)
Line error detection	
Switching output	Relay output Contact material Maximum switching voltage Maximum switching current Minimum contact current Switching frequency
General data	Supply voltage U_B Nominal supply voltage Current consumption Power consumption Electrical isolation Test voltage, input/output/supply Degree of protection Ambient temperature (operation) Mounting Housing material Dimensions W / H / D Screw connection solid / stranded / AWG Spring-cage connection (solid/stranded/AWG)
Conformance / approvals	Conformance ATEX UL, USA / Canada
GL	

Technical data

NAMUR proximity sensors (EN 60947-5-6) Open circuit switch contacts Switch contacts with resistance circuit
8.2 V DC $\pm 10\%$ < 1.2 mA (blocking) > 2.1 mA (conductive) > 6 mA (in the event of a short-circuit) < 0.35 mA (With wire break)
2 N/O contacts Hard gold plated AgNi 250 V AC 2 A 1 mA (for 5 V DC) 0.5 Hz (240 V AC / 30 V DC / 2 A) 10 Hz (without load)
19.2 V DC ... 30 V DC 24 V DC < 25 mA < 600 mW Basic insulation according to EN 61010 1.5 kV (50 Hz, 1 min.) IP20 -20°C ... 65°C Any PBT 6.2 / 93.1 / 102.5 mm 0.2 ... 2.5 mm ² / 0.2 ... 2.5 mm ² / 26 - 12 0.2 ... 2.5 mm ² / 0.2 ... 2.5 mm ² / 24 - 12
CE-compliant Ex II 3 G Ex nA nC IIC T4 Gc X UL 508 Recognized Class I, Div. 2, Groups A, B, C, D T5 applied for GL EMC 2 D

Ordering data

Description	Type	Order No.	Pcs. / Pkt.
MCR NAMUR switching amplifier	MINI MCR-SL-NAM-2RNO ¹⁾	2864105	1
	MINI MCR-SL-NAM-2RNO-SP ¹⁾	2810269	1

Accessories
Constant voltage source

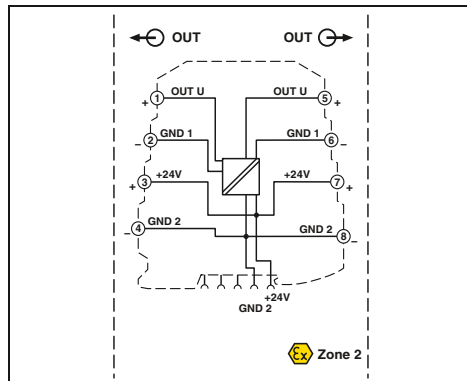
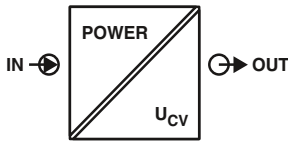

Ex n



Configurable,
output signals 2.5 V / 5 V / 7.5 V / 10 V

Ex: Applied for: cUL / UL
Housing width 6.2 mm

- Constant voltage source for potentiometers, measuring bridges, encoders
- Highly precise
- Input signal corresponds to power supply
- Input signal and, in turn, the power supply can be provided via the foot element (T-Connector)
- Standard configuration:
Output 10 V DC

Notes:

Information on components for power bridging, system cabling, and marking can be found in the INTERFACE catalog or at www.phoenixcontact.net/products

1) EMC: Class A product, see page 571

Input data	Input signal
Output data	Output signal (can be configured using DIP switches)

Short-circuit current
Ripple

General data

Supply voltage U_B
Power consumption
Maximum transmission error
Temperature coefficient
Electrical isolation
Test voltage input/output
Degree of protection
Ambient temperature (operation)
Housing material
Dimensions W / H / D
Screw connection solid / stranded / AWG
Spring-cage connection (solid/stranded/AWG)
Conformance / approvals
Conformance
ATEX
UL, USA / Canada

Technical data

9.6 ... 30 V
10 V DC
7.5 V DC
5 V DC
2.5 V DC
Approx. 32 mA
< 20 mV_{PP}
9.6 V DC ... 30 V DC
< 600 mW (at 24 V IN)
≤ 0.1% (of final value)
< 0.01%/K, typ. < 0.002%/K
Basic insulation according to EN 61010
1.5 kV (50 Hz, 1 min.)
IP20
-20°C ... 65°C
PBT
6.2 / 93.1 / 102.5 mm
0.2 ... 2.5 mm² / 0.2 ... 2.5 mm² / 26 - 12
0.2 ... 2.5 mm² / 0.2 ... 2.5 mm² / 24 - 12
CE-compliant
 II 3 G Ex nA IIC T4 Gc X
UL 508 Recognized
Class I, Div. 2, Groups A, B, C, D T5

Description	
MCR constant voltage source	
With screw connection	Screw connection
With spring-cage connection	Spring-cage conn.

Setpoint potentiometer, to set setpoints individually

Resistance value 4.7 kΩ
Resistance value 10 kΩ

Ordering data

Type	Order No.	Pcs. / Pkt.
MINI MCR-SL-CVS-24-5-10-NC ¹⁾	2902822	1
MINI MCR-SL-CVS-24-5-10-SP-NC ¹⁾	2902823	1

Accessories

EMG 30-SP- 4K7LIN	2940252	10
EMG 30-SP-10K LIN	2942124	10

Accessories

Feed-through terminal blocks

- Feed-through terminal block for 1:1 forwarding of signals in the MINI Analog group
- For plugging gaps in system cabling with the V8 system adapter, e.g., when there are fewer than eight signals
- Used in conjunction with the MINI Analog multiplexer
- For direct mounting in the case of applications without signal conversion and without electrical isolation

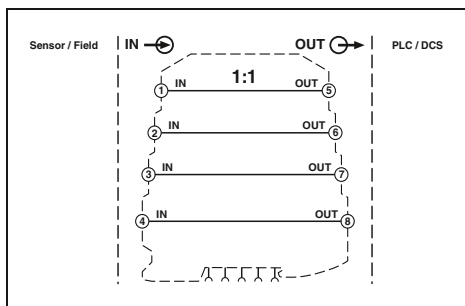

Ex n



1:1 connection

General data	
Degree of protection	IP20
Ambient temperature (operation)	-20°C ... 65°C
Mounting	Any
Housing material	PBT
Dimensions W / H / D	6.2 / 93.1 / 102.5 mm
Screw connection solid / stranded / AWG	0.2 ... 2.5 mm ² / 0.2 ... 2.5 mm ² / 24 - 12
Conformance / approvals	
ATEX	Ex II 3 G Ex nA IIC T4 Gc X
GL	GL EMC 2 D

Technical data

Degree of protection	IP20
Ambient temperature (operation)	-20°C ... 65°C
Mounting	Any
Housing material	PBT
Dimensions W / H / D	6.2 / 93.1 / 102.5 mm
Screw connection solid / stranded / AWG	0.2 ... 2.5 mm ² / 0.2 ... 2.5 mm ² / 24 - 12
Conformance / approvals	
ATEX	Ex II 3 G Ex nA IIC T4 Gc X
GL	GL EMC 2 D

Description
MINI Analog feed-through terminal block

Screw connection

Ordering data

Type	Order No.	Pcs. / Pkt.
MINI MCR-SL-TB	2811420	1

Accessories

Marking material

- Flexible labeling system with pivoting transparent cover and matching insert strips
- Transparent cover that can be snapped onto the module instead of the standard cover
- Insert strips on pre-punched paper sheets
- Marking option for standard cover in the form of ZBF 6 zack marker strip marking labels

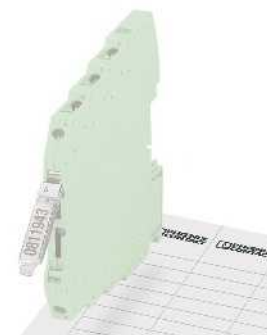

Transparent cover with insert strips

Description
Fold-up transparent cover , for labeling MINI Analog modules with insert strips

Insert strips , stamped, for transparent cover

Zack marker strip, flat
UniCard sheets , for marker groove

Ordering data

Type	Order No.	Pcs. / Pkt.
MINI MCR DKL	2308111	10

Accessories

MINI MCR-DKL-LABEL	2810272	10
ZBF 6 (see Catalog 5)		
UC-TMF 6 (see Catalog 5)		

Accessories

Power terminals

- For up to 80 MINI Analog modules
- The MINI MCR-SL-PTB-FM(-SP) power terminal block is used to supply the supply voltage to the DIN rail connector
- Monitoring of supplies in combination with the fault monitoring module
- Flexible redundant supply from one or both module sides
- Extended supply voltage range from 0 ... 30 V DC

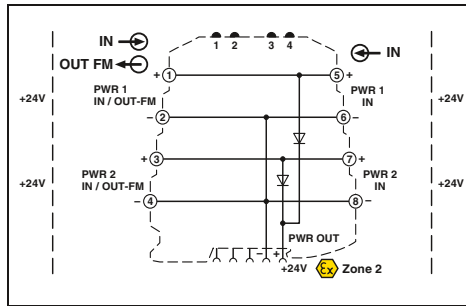

Power terminal block, can be monitored

Notes:
1) EMC: Class A product, see page 571

Input data
Input voltage range
Output data
Output voltage
Output current
General data
Ambient temperature (operation)
Conformance / approvals
Conformance
ATEX
UL, USA / Canada
GL

Technical data	
Input voltage range	0 V DC ... 30 V DC
Output voltage	(Input voltage - 0.8 V)
Output current	≤ 2 A
Ambient temperature (operation)	-20°C ... 65°C
Conformance / approvals	CE-compliant Ex II 3 G Ex nA IIC T4 Gc X UL 508 Recognized applied for Class I, Div. 2, Groups A, B, C, D T5 applied for GL applied for

Description
MINI Analog power terminal blocks

Ordering data		
Type	Order No.	Pcs. / Pkt.
MINI MCR-SL-PTB-FM ¹⁾	2902958	1
MINI MCR-SL-PTB-FM-SP ¹⁾	2902959	1

Accessories

Error message modules

- Fault monitoring module for evaluating and reporting group errors from the fault monitoring system.
- Monitoring of supply voltages of MINI MCR-SL-PTB-FM(-SP) power terminal blocks
 - Drawing off the supply is possible
 - The error is reported via an N/C contact
 - Standard configuration: group error detection "ON"; redundancy monitoring "ON"; relay "active"

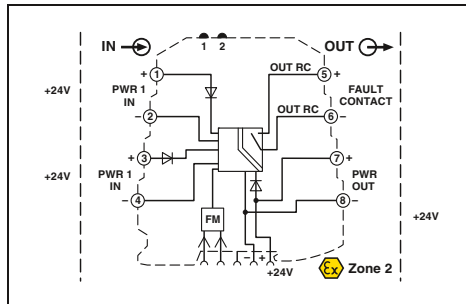

Group error message and Supply monitoring

Notes:
1) EMC: Class A product, see page 571

Input data/output data
Input signal
Output signal
Output signal maximum current
Switching output
Maximum switching voltage
Maximum switching current
Test voltage input/output
Conformance / approvals
Conformance
ATEX
UL, USA / Canada
GL

Technical data	
Input signal	9.6 V DC ... 30 V DC
Output signal	9.6 V DC ... 30 V DC
Output signal maximum current	2 A
Maximum switching voltage	30 V DC
Maximum switching current	50 mA
Test voltage input/output	1.5 kV AC (50 Hz, 1 min.)
Conformance / approvals	CE-compliant Ex II 3 G Ex nA nC IIC T4 Gc X UL 508 Recognized applied for Class I, Div. 2, Groups A, B, C, D T5 applied for GL applied for

Description	
MINI Analog error message modules	
Standard configuration	Screw connection
Standard configuration	Spring-cage conn.

Ordering data		
Type	Order No.	Pcs. / Pkt.
MINI MCR-SL-FM-RC-NC ¹⁾	2902961	1
MINI MCR-SL-FM-RC-SP-NC ¹⁾	2902962	1

Accessories

ME 6,2 TBUS... T-Connector

- For bridging the supply voltage
- Reduces wiring costs
- Module can be replaced without interrupting the supply to the remaining modules (hot swap)
- One T-Connector for two MINI Analog modules
- Current carrying capacity of 2 A to MINI Analog modules



For bridging the supply voltage

Description
DIN rail connector (TBUS) , for bridging the supply voltage, can be snapped onto 35 mm DIN rails as per EN 60715, with UL approval

Ordering data		
Type	Order No.	Pcs. / Pkt.
ME 6,2 TBUS-2 1,5/5-ST-3,81 GN	2869728	10

Accessories

Power terminals

- For supplying the supply voltage via the foot element (T-Connector) where DC voltages of up to 30 V are already available
- Option of redundant supply decoupled from diode
- For up to 80 MINI analog modules
- For up to 2 A
- Status and error signaling via diagnostic LEDs

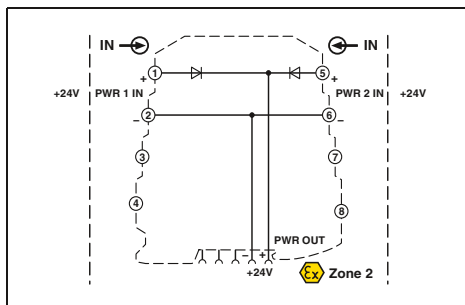

Ex n



Redundant supply for existing 24 V

Notes:
Recommended fuse for power terminal block: Fuse according to IEC 60127-2/V Nominal current: 2.5 A Characteristics: Slow-blow (e.g., Wickmann 5 x 20 mm/No. 195 - glass fuse)
1) EMC: Class A product, see page 571

Input data
Input voltage range
Output data
Output voltage
Output current
General data
Ambient temperature (operation)
Housing material
Conformance / approvals
Conformance
ATEX
UL, USA / Canada
GL

Technical data	
Input voltage range	20 V DC ... 30 V DC
Output data	(Input voltage - 0.8 V)
Output current	≤ 2 A
Ambient temperature (operation)	-20°C ... 65°C
Housing material	PBT
Conformance	CE-compliant
ATEX	Ex II 3 G Ex nA IIC T4 Gc X
UL, USA / Canada	UL 508 Recognized Class I, Div. 2, Groups A, B, C, D T5
GL	GL EMC 2 D

Description
MCR power terminal block

Ordering data		
Type	Order No.	Pcs. / Pkt.
MINI MCR-SL-PTB ¹⁾	2864134	1
MINI MCR-SL-PTB-SP ¹⁾	2864147	1

Accessories
ME 17,5 TBUS...T-Connector

- For bridging the supply voltage when using a MINI POWER system power supply

Notes:

If the system power supply is used, you need two ME 17,5 TBUS T-Connectors to establish the connection with the ME 6,2 TBUST-Connectors of the MINI Analog system and provide an effective power supply.

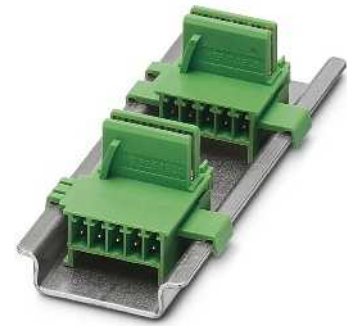

For system power supply

Description
DIN rail connector , for bridging the supply voltage, can be snapped onto 35 mm DIN rails as per EN 60715, with UL approval, two pieces are required per system power supply

Ordering data		
Type	Order No.	Pcs. / Pkt.
ME 17,5 TBUS 1,5/ 5-ST-3,81 GN	2709561	10

Accessories
System power supply

- For supplying the supply voltage via the foot element (T-Connector) where AC voltages are available
- 100 ... 240 V AC nominal input voltage range
- 24 V DC output voltage
- For up to 60 MINI Analog modules
- For up to 1.5 A, secondary
- Status and error signaling via diagnostic LEDs



For applications with local voltages of over 100 V

Description
System power supply unit , primary-switched with zone 2 approval. More information is given in the INTERFACE Power Supply catalog part.
System power supply unit , primary-switched (not for zone 2). More information is given in the INTERFACE Power Supply catalog part.

Ordering data		
Type	Order No.	Pcs. / Pkt.
MINI-PS-100-240AC/24DC/1.5/EX	2866653	1
MINI-SYS-PS-100-240AC/24DC/1.5	2866983	1

Accessories

System cabling

A high number of channels enables analog signal transmission across 6 mm in a confined space for many applications. In this kind of context, in particular, it is really important to have access to wiring solutions that avoid errors and are time-efficient, thereby cutting costs.

The MINI Analog system cabling solution allows you to wire up to eight channels quickly, easily, and without errors.

System cabling can take various forms.

System cabling with a front adapter

This includes:

- A 16-pos. FLK cable
- The V8 system adapter for MINI Analog modules
- A front adapter that needs to be specifically selected based on the analog card of the controller

With this solution, all you need to do is connect the components together. There is virtually no wiring effort involved. What's more, it completely rules out wiring errors, as the pre-assembled components ensure correct assignment by virtue of their design.

System cabling without a front adapter

The version that does not require the use of a front adapter is the ideal addition.

This solution involves using a 16-pos. FLK cable with open ends on one side. The open ends are fitted with ferrules and are numbered. This allows you to create a system cabling connection to virtually any module without having to fit a front adapter. The other advantage is that you can implement system cabling on the module side quickly, easily, and without errors.

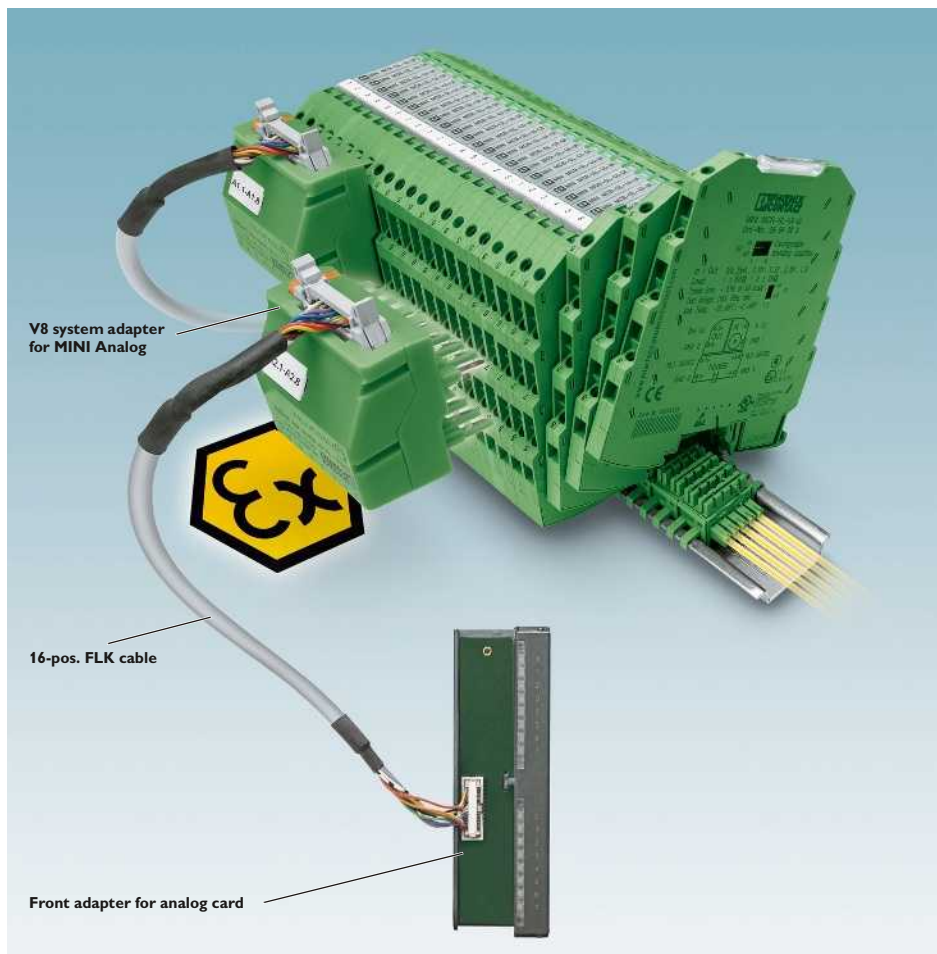

System cabling with a front adapter

The tables below are designed to serve as a configuration aid. Details of other solutions are available on the Internet or on request.

Configuration aid for MINI Analog system cabling				
Controller	Analog card	Front adapter	FLK cable	V8 system adapter for MINI Analog
Siemens SIMATIC S7-300 / ET 200 M	6ES7-331-7KF02-0AB0	FLKM 16-PA-S300/MINI-MCR (in the catalog on page 454)	FLK 16/EZ-DR/.../KONFEK (non-molded plugs, in the catalog on page 506)	MINI MCR-SL-V8-FLK 16-A (in the catalog on page 94)
	6ES7-331-7KB02-0AB0			
	6ES7-331-7KB81-0AB0			
	6ES7-331-7TF00-0AB0			
	6ES7-332-8TF01-0AB0			
	6ES7-331-1KF01-0AB0 (for current signals)	FLKM 16-PA-331-1KF//MINI-MCR (in the catalog on page 455)		
	6ES7-331-5HF00-0AB0 (for current signals)	FLKM 16-PA-332-5HF//MINI-MCR (in the catalog on page 455)		
Yokogawa Centum CS 3000 R3	AAI 141	Not required	CABLE-40/2/FLK16/.../YUC (non-molded plugs, in the catalog on page 467)	2 x MINI MCR-SL-V8-FLK 16-A (in the catalog on page 94)
	AAI 143			
Miscellaneous controllers / actuators / sensors	All cards	Not required	CABLE-FLK16/OE/0,14/...M (non-molded plugs, in the catalog on page 502)	MINI MCR-SL-V8-FLK 16-A (in the catalog on page 94)
			or alternatively VIP-CAB-FLK16/FR/OE/0,14/...M (molded plugs, in the catalog on page 502)	

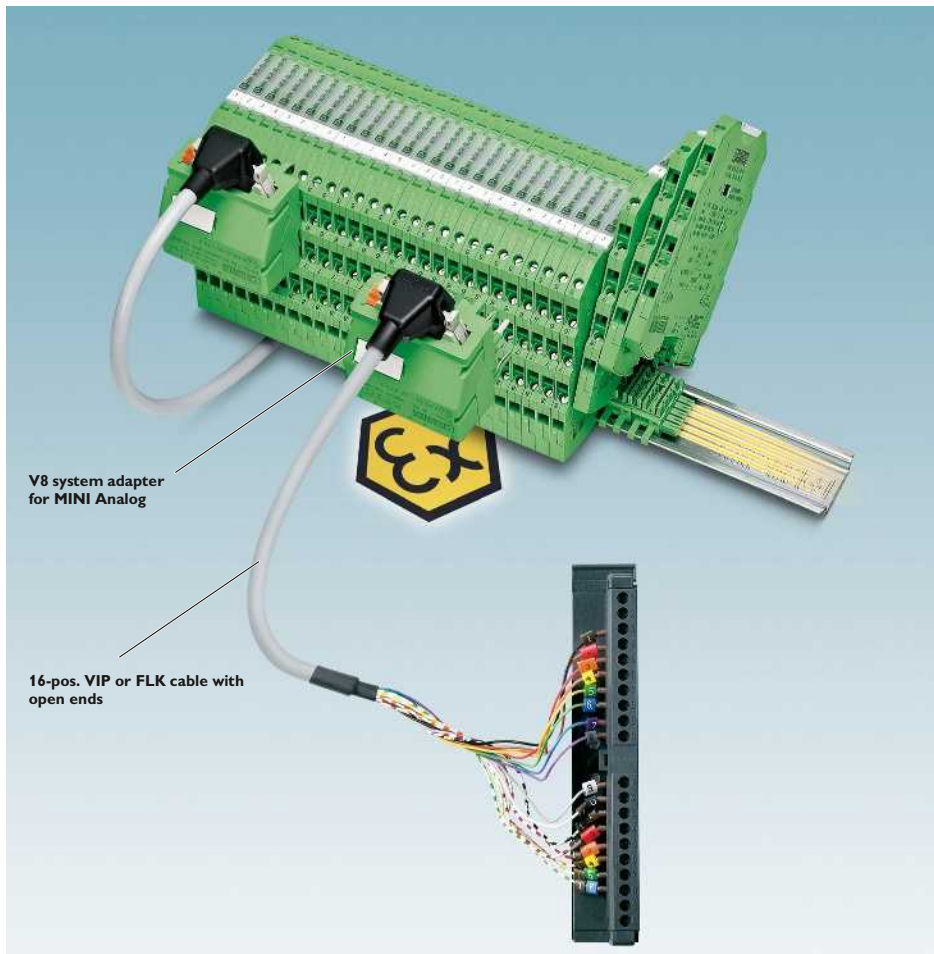

V8 system adapter for MINI Analog

16-pos. VIP or FLK cable with open ends

System cabling without a front adapter

Innovative concept

Thanks to its innovative design concept, the MINI MCR-SL-V8-FLK 16 A MINI Analog system adapter can be used on both the input and output side. Consequently, there is nothing at all to prevent you from using the same components for system cabling on both output and input modules.

Complete flexibility

The proven FLK cable series offers complete flexibility in terms of selection and is the ideal solution for system cabling with a front adapter. The flat and flexible plug connections mean that the products can be easily installed in any analog module.

Increased protection

The new VIP cables with molded FLK plugs offer enhanced protection in harsh industrial environments. If you opt for system cabling without a front adapter, you can enjoy all the advantages of the new VIP cables on the system adapter side.

Addition

If the application demands a form of system cabling with fewer than eight channels, the MINI MCR-SL-TB feed-through terminal block (page 88) represents the perfect addition.



Plug-in connection



Innovative concept



Complete flexibility



Increased protection



Addition

Accessories

MINI Analog system adapter

- Time-saving wiring solution thanks to unique plug-in concept
- System cabling on PLC side
- Plug and play
- For up to eight channels
- Reduces wiring costs and errors



System adapter



Housing width 50.4 mm

Technical data

General data	
Contact resistance	< 10 mΩ
Current carrying capacity	≤ 1 A
Test voltage	500 V (50 Hz, 1 min. from channel to channel)
Vibration resistance	≤ 0.7 g
Surge voltage category / Pollution degree	III / 2
Ambient temperature (operation)	-20°C ... 60°C
Housing material	PBT
Dimensions W / H / D	50.4 / 46.2 / 45.5 mm
Connection to the signal level	Flat-ribbon cable plug connector according to IEC 60603-13

Insertion/withdrawal cycles (System adapter / FLK 16)	10 / ≥ 200
---	------------

Conformance / approvals	
ATEX	Ex II 3 G Ex nA IIC T4 Gc X
UL, USA / Canada	UL 508 Recognized Class I, Div. 2, Groups A, B, C, D T5 applied for
GL	GL EMC 2 D

Ordering data

Description		
Type	Order No.	Pcs. / Pkt.
System adapter , for MINI analog modules with screw connection		
MINI MCR-SL-V8-FLK 16-A	2811268	1

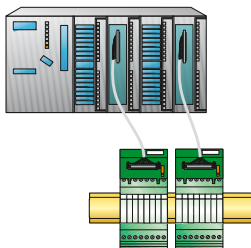

MINI Analog system cabling

Accessories

MINI Analog multiplexer

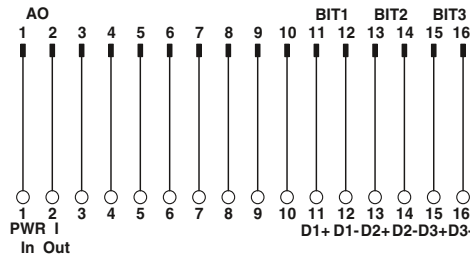

FLK pin strip assignment

- Generates an analog output from up to eight analog input signals – parallel analog signals are transmitted serially via a cable
- The desired number of channels is selected via DIP switches (8, 6, 4 or 2 channels)
- The channel currently switched is indicated as a bit pattern via three digital outputs
- Two clock cycles for execution can be selected via DIP switches (one- or two-second clock)
- Supplied by an output loop
- For 4 ... 20 mA current signals
- Can be easily snapped onto MINI Analog modules with screw connection
- Huge reduction in analog inputs at controllers
- System cabling on the output side using pre-assembled FLK cables with open ends.

Notes:

For six, four or two channels you will also need the corresponding number of feed-through terminal blocks (i.e., two, four or six).

1) EMC: Class A product, see page 571

Input data

Description
Can be configured/parameterized
Input signal
Maximum input signal
Switching cycles

Output data

Output signal
Maximum output signal
Load R_B
Status indication Active input

Switching output

Maximum switching voltage

General data

Supply voltage U_B
Current consumption
Power consumption
Maximum transmission error
Temperature coefficient
Ambient temperature (operation)
Housing material
Dimensions W / H / D
Connection to control level

Insertion/withdrawal cycles (System adapter / FLK 16)

Conformance / approvals

Conformance
ATEX
UL, USA / Canada

Ex:

Housing width 50.4 mm

Technical data

2, 4, 6, or 8-channel (can be switched over)
Via DIP switches
4 ... 20 mA
< 30 mA
2 or 1 sec. (can be selected)

4 ... 20 mA

< 30 mA
 $((U_{supply} - 7 V) / I_{max})$

1, 2, 3-bit digital output (can be selected)

3 x PNP optocouplers
30 V DC

7 V DC ... 30 V DC (Loop-powered)

< 3.5 mA (without signal current)

< 24 mW (without signal current)

0.3% (0.1%, typical)

< 0.01%/K

-20°C ... 65°C

PBT

50.4 / 45.5 / 46.2 mm

Flat-ribbon cable plug connector according to IEC 60603-13

10 / ≥ 200

CE-compliant

II 3 G Ex nA IIC T4 Gc X

UL 508 Recognized applied for

Class I, Div. 2, Groups A, B, C, D T5 applied for

Ordering data

Type	Order No.	Pcs. / Pkt.
MINI MCR-SL-MUX-V8-FLK 16 ¹⁾	2811815	1

Accessories

MINI MCR-SL-TB	2811420	1
----------------	---------	---

VIP-CAB-FLK16/FR/OE/0,14/...

CABLE-FLK16/OE/0,14/...

Description
Multiplexer for MINI Analog modules with screw connection

MINI Analog feed-through terminal block

For round cable with one open end, see "System cabling for controllers" section
For round cable with one open end, see "System cabling for controllers" section

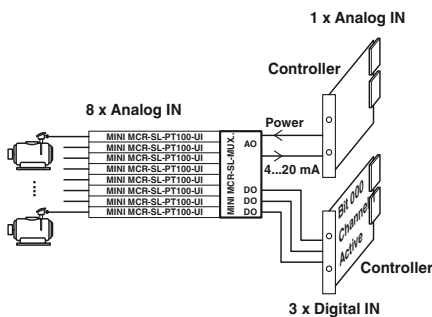

Monitoring of eight motor temperatures with just one analog control input

Termination carrier for MINI Analog isolating amplifier



TC... termination carriers are compact solutions for conveniently and smoothly connecting standard DIN rail isolating amplifiers from the MINI Analog series to input/output cards of automation systems using system cables.

The most compact isolating amplifiers combined with the most compact and flexible module carriers on the market enable you to achieve a hitherto unparalleled packing density in your control cabinet together with professional system cabling.

Compact

- The compact design associated with MINI Analog saves up to 65% of space in the control cabinet

Robust and reliable

- Stable, vibration-resistant aluminum carrier device profile
- PCB is completely decoupled from isolating amplifiers
- PCB without active electronics
- Redundant supply via separate DIN rail module
- Horizontal or vertical DIN rail mounting

Flexible

- Profile sections without pitch markings
- Quick and safe module connection with plug-in cable sets
- Horizontal or vertical DIN rail mounting
- Can be flexibly adapted to suit any controller or higher-level control system
- Solutions tailored to your requirements on request
- Available pre-assembled with modules and wired, or for self-assembly



Select standard DIN rail device



Select module carrier



Select controller-specific front adapter and system cable



Solutions are also available for MACX Analog, MACX Analog Ex, and Safety

Termination carrier for MINI Analog isolating amplifier

The **TC-D37SUB-ADIO16-M-P-UNI** universal termination carrier is a compact solution which connects isolating amplifiers from the MINI Analog series to input/output cards of automation systems.

The **TC-D37SUB-AIO16-M-PS-UNI** termination carrier version also enables the coupling and decoupling of HART signals.

- Connection of up to 16 channels
- Can be universally connected, thanks to 37-pos. D-SUB cable with open ends. This enables flexible connection to automation systems
- Redundant power supply, decoupled from diode via separate MINI MCR-PTB power module and MINI MCR-SL-TB feed-through terminal block

Notes:
Contact us: together, we can develop optimum solutions for your automation system with the termination carrier for MINI Analog.
1) EMC: Class A product, see page 571



General data	
Connection to the control system level	D-SUB pin strip
Number of positions	37
Maximum operating voltage	< 50 V DC (Per signal/channel)
Maximum permissible current	1 A (Signal/channel)
Rated insulation voltage	50 V
Surge voltage category	II
Pollution degree	2
Rated surge voltage	0.5 kV
Air and creepage distances	DIN EN 50178 (Basic insulation)
Degree of protection	IP20
Ambient temperature range	-40°C ... 80°C (Please observe module specifications)
Shock	15g, according to IEC 60068-2-27
Vibration (operation)	2g, according to IEC 60068-2-6
Inflammability class according to UL 94	V0
Dimensions W / H / D	136 / 170 / 160 mm
Power supply via power module	
Input voltage range	19.2 V DC ... 30 V DC
Redundant supply	yes, decoupled from diodes
Polarization and surge protection	Yes
Fuse	2.5 A Slow-blow
Status indication	2 x red LED (error) 1 x green LED (PWR)

Housing width 136 mm

Technical data	
D-SUB pin strip	37
Maximum operating voltage	< 50 V DC (Per signal/channel)
Maximum permissible current	1 A (Signal/channel)
Rated insulation voltage	50 V
Surge voltage category	II
Pollution degree	2
Rated surge voltage	0.5 kV
Air and creepage distances	DIN EN 50178 (Basic insulation)
Degree of protection	IP20
Ambient temperature range	-40°C ... 80°C (Please observe module specifications)
Shock	15g, according to IEC 60068-2-27
Vibration (operation)	2g, according to IEC 60068-2-6
Inflammability class according to UL 94	V0
Dimensions W / H / D	136 / 170 / 160 mm
Power supply via power module	
Input voltage range	19.2 V DC ... 30 V DC
Redundant supply	yes, decoupled from diodes
Polarization and surge protection	Yes
Fuse	2.5 A Slow-blow
Status indication	2 x red LED (error) 1 x green LED (PWR)

Description	
Module carrier for 16 MINI Analog channels, power and feed-through module	
- With connection for MACX MCR-S-MUX HART multiplexer	

Ordering data		
Type	Order No.	Pcs. / Pkt.
TC-D37SUB-ADIO16-M-P-UNI	2902933	1
TC-D37SUB-AIO16-M-PS-UNI ¹⁾	2902934	1

Accessories			
MINI Analog power terminal blocks	MINI MCR-SL-PTB-FM ¹⁾	2902958	1
MINI Analog error message modules	MINI MCR-SL-FM-RC-NC ¹⁾	2902961	1
HART multiplexer, 32-channel, including two 14-wire flat-ribbon cables	MACX MCR-S-MUX	2865599	1

Accessories			
MINI Analog power terminal blocks	MINI MCR-SL-PTB-FM ¹⁾	2902958	1
MINI Analog error message modules	MINI MCR-SL-FM-RC-NC ¹⁾	2902961	1
HART multiplexer, 32-channel, including two 14-wire flat-ribbon cables	MACX MCR-S-MUX	2865599	1

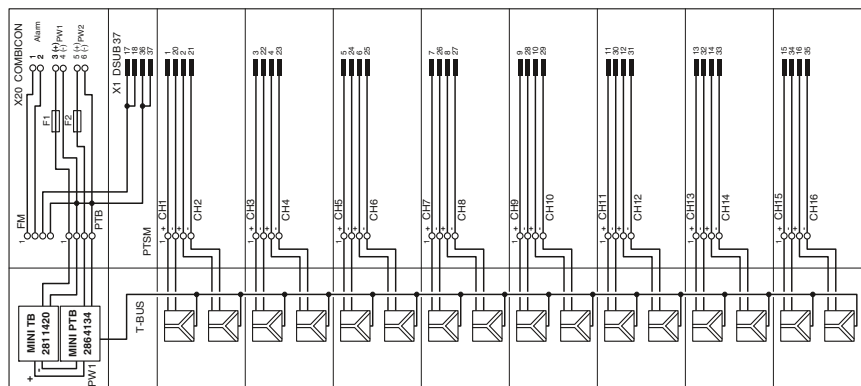

TC-D37SUB-ADIO16-M-P-UNI and TC-D37SUB-AIO16-M-PS-UNI connection scheme

Accessories

Surge protection

LINETRAB LIT

The ideal addition to MINI Analog - the innovative surge protection solution in 6.2 mm housing.

Because the LINETRAB LIT and MINI Analog housing is the same shape, you can benefit from the numerous advantages of system cabling. The advantage of combining MINI Analog and LINETRAB LIT products is that it enables you to set up a space-saving, protected, and optimally coordinated signal chain from the sensor right up to the controller.

The tables below are designed to serve as configuration aids for combining MINI Analog and LINETRAB products.

On the left, you will find a list of the components and combination options for setting up system cabling between MINI Analog and LINETRAB.

For details of system cabling solutions that can be used between MINI Analog and the controller side, please refer to page 92.

For more detailed information on LINETRAB LIT surge protection modules, please see the TRABTECH catalog.

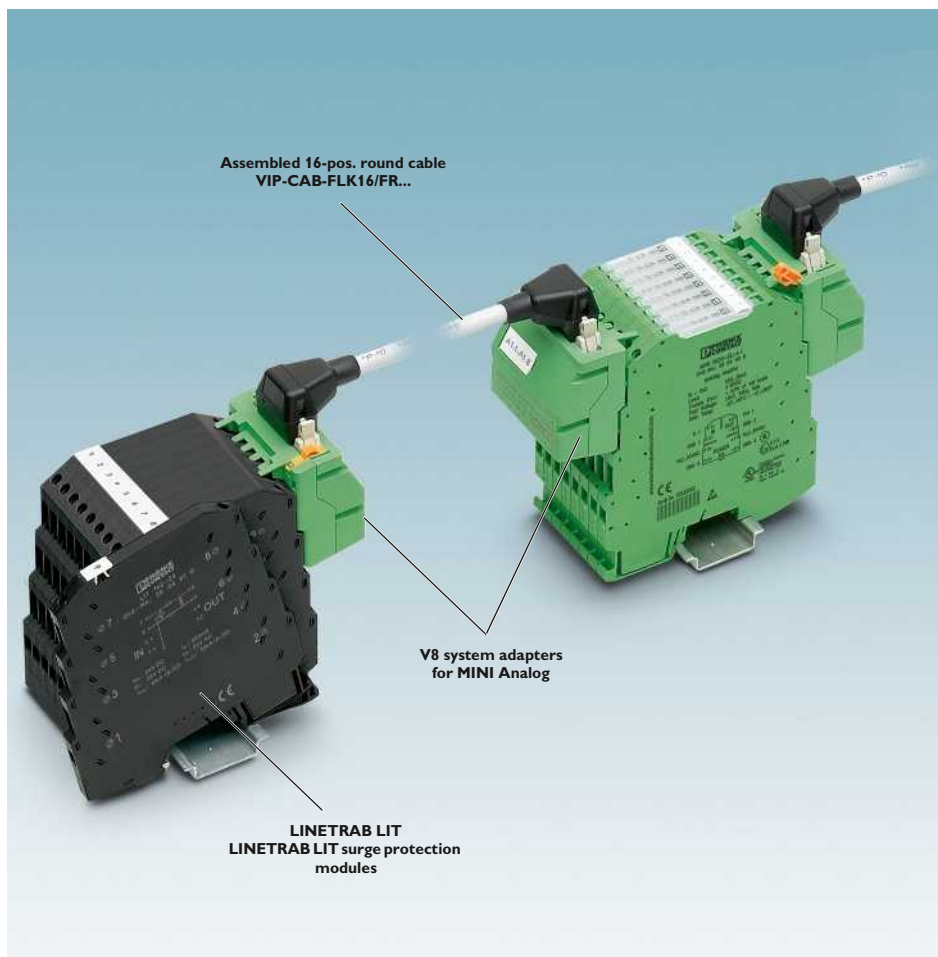

Reliable and systematic measurements - LINETRAB LIT and MINI Analog

Configuration aid for LINETRAB LIT - MINI Analog

Cabling via MINI Analog system adapter (8 modules)

LINETRAB LIT (surge protection)		MINI Analog	
Type	Order No.	Type	Order No.
LIT 1X2-24	2804610	MINI MCR-SL-UI-UI	2864383
		MINI MCR-SL-UI-UI-NC	2864150
		MINI MCR-SL-U-UI-NC	2865007
		MINI MCR-SL-U-I-0	2813512
		MINI MCR-SL-U-I-4	2813525
		MINI MCR-SL-I-U-0	2813541
		MINI MCR-SL-I-U-4	2813538
		MINI MCR-SL-I-I	2864406
		MINI MCR-SL-U-U	2864684
		MINI MCR-SL-UI-2I	2864794
		MINI MCR-SL-UI-2I-NC	2864176
		MINI MCR-SL-RPS-I-I	2864422
		MINI MCR-SL-RPSS-I-I	2864079
		MINI MCR-SL-1CP-I-I	2864419
		MINI MCR-SL-UI-F	2864082
		MINI MCR-SL-NAM-2RNO	2864105
MINI MCR-SL-UI-REL	2864480		
MINI MCR-SL-SHUNT-UI	2810858		
MINI MCR-SL-SHUNT-UI-NC	2810780		

Components required for system cabling

Available 16-pos. VIP... round cables			V8 system adapter for MINI Analog
Type	Length	Order No.	Type
VIP-CAB-FLK16/FR/FR/0,14/0,5M	0.5 m	2900154	2 x MINI MCR-SL-V8-FLK 16-A (in the catalog on page 94)
VIP-CAB-FLK16/FR/FR/0,14/1,0M	1.0 m	2900155	
VIP-CAB-FLK16/FR/FR/0,14/2,0M	2.0 m	2900156	

VIP... round cables are available in special lengths on request.

VIP system cable

The new VIP cables provide a way of setting up secure and robust connections, even in harsh industrial environments.

Innovative concept

The MINI Analog system adapter does not just support system cabling on the input and output sides. It also allows cabling to be installed with LINETRAB surge protection modules quickly, easily, and without errors.

Increased protection

In addition to all the advantages associated with electrical isolation, filtering, amplification, and the conversion of standard analog signals using MINI Analog, there is now also the option of effective surge protection.

Surge protection

Surge protection is a reliable means of actively preventing and protecting against system damage and downtimes. LINETRAB is able to limit transient surge voltages safely and without affecting the signal - all in a compact device with a design width of just 6.2 mm.



VIP system cable



Innovative concept



Increased protection



Surge protection

Configuration aid for LINETRAB LIT - MINI Analog

Manual cabling

LINETRAB LIT (surge protection)		MINI Analog	
Type	Order No.	Type	Order No.
LIT 1X2-24	2804610	MINI MCR-SL-UI-UI	2864383
		MINI MCR-SL-UI-UI-NC	2864150
		MINI MCR-SL-UI-UI-SP	2864710
		MINI MCR-SL-UI-UI-SP-NC	2864163
		MINI MCR-SL-SHUNT-UI-SP	2810874
		MINI MCR-SL-SHUNT-UI-SP-NC	2810793
		MINI MCR-SL-U-UI-SP	2811213
		MINI MCR-SL-U-UI-SP-NC	2810078
		MINI MCR-SL-U-I-0-SP	2813570
		MINI MCR-SL-U-I-4-SP	2813583
		MINI MCR-SL-I-U-0-SP	2813554
		MINI MCR-SL-I-U-4-SP	2813567
		MINI MCR-SL-I-I-SP	2864723
		MINI MCR-SL-U-U-SP	2864697
		MINI MCR-SL-UI-2I-SP	2864804
		MINI MCR-SL-UI-2I-SP-NC	2864189
		MINI MCR-SL-RPS-I-I-SP	2864752
		MINI MCR-SL-RPSS-I-I-SP	2810230
		MINI MCR-SL-1CP-I-I-SP	2864749
		LIT 2X2-24	2804623
MINI MCR-SL-2CP-I-I-SP	2864781		
LIT 2-12 (for 2-conductor connection technology)	2804665	MINI MCR-SL-PT100-UI-200	2864309
		MINI MCR-SL-PT100-UI-200-NC	2864370
		MINI MCR-SL-PT100-UI-200-SP	2864192
		MINI MCR-SL-PT100-UI-200-SP-NC	2864202
		MINI MCR-SL-PT100-UI	2864435
		MINI MCR-SL-PT100-UI-NC	2864273
		MINI MCR-SL-PT100-UI-SP	2864736
		MINI MCR-SL-PT100-UI-SP-NC	2864286
		MINI MCR-SL-PT100-UI-LP	2810298
		MINI MCR-SL-PT100-UI-LP-NC	2810308
		MINI MCR-SL-PT100-UI-LP-SP	2810382
		MINI MCR-SL-PT100-UI-LP-SP-NC	2810395
LIT 1X2-24	2804610	MINI MCR-SL-UI-F-SP	2810243
		MINI MCR-SL-NAM-2RNO-SP	2810269
		MINI MCR-SL-UI-REL-SP	2864493
LIT 4-24	2804678	MINI MCR-SL-R-UI	2864095
		MINI MCR-SL-R-UI-SP	2810256



Reliable and safe

MACX Analog - safe and high-performance signal isolating amplifiers. This product range enables you to safely isolate, condition, filter, and amplify all the signals of your system.

In all phases of the product life cycle, the MACX Analog range has been consistently developed and produced according to standards for functional safety. Save planning and operating costs – by combining high signal flexibility with safe isolation and SIL evaluation.

The universal nature of the product range provides you with a solution for all applications using analog signal transmission. You are free to choose between either multi-functional high-end devices or reasonably-priced standard modules with exactly the right functions.

Choose the right MACX Analog isolating amplifier for your application:

Analog IN/OUT

- Configurable 3-way isolating amplifiers
- Repeater power supplies with HART signal transmission for supplying 2-conductor transmitters
- Output isolating amplifiers with HART signal transmission

Temperature

- Universal temperature transducers for resistance thermometers, resistance-type sensors, potentiometers, thermocouples, and mV sources – also with safe limit value relays as an option
- Configurable temperature transducer for resistance thermometers and resistance-type sensors
- Configurable temperature transducer for thermocouples and mV sources

Digital IN

- Isolation amplifiers with input for NAMUR proximity sensor or switch
- Single-channel with PDT or passive transistor output
- Single-channel with double N/O contact output
- Two-channel with one N/O contact output per channel
- Two-channel with one PDT or passive transistor output per channel

Functional safety – from the initial idea to the finished product

Phoenix Contact meets the requirements of functional safety according to IEC 61508 in a standardized development process. Here, all fault avoidance and fault control measures are taken into consideration, from the very development and production

of a device right up to device operation. These measures are audited within the scope of a full assessment by an independent test center.

Phoenix Contact therefore makes a significant contribution to high system safety and availability.



DIN rail connector-compatible

The DIN rail connector enables the modular bridging of the 24 V supply voltage.



Wide-range power supply

The modules featuring a wide-range power supply (...-UP) can be used in all power supply networks the world over without the need for additional power supply units.



Safe and reliable functions

– Consistent SIL certification. This ensures the highest level of reliability and safety for your systems.



Precise transmission and high operational reliability

– Thanks to patented transmission concept



Easy configuration

– Without software via DIP switches on the device front or with the operator interface and display unit.

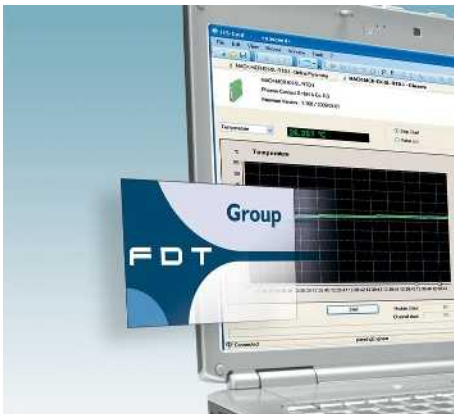

Easy configuration and monitoring

– Either via FDT/DTM or user-friendly stand-alone software – with integrated monitoring function.

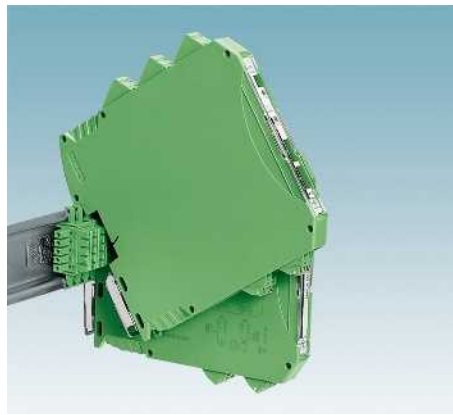

Flexible power bridging

– The DIN rail connector simplifies wiring, system expansion or module replacement during operation.



Easy-maintenance connection technology

– Plug-in connection terminal blocks with screw connection or fast push-in technology – coded, with integrated sockets.

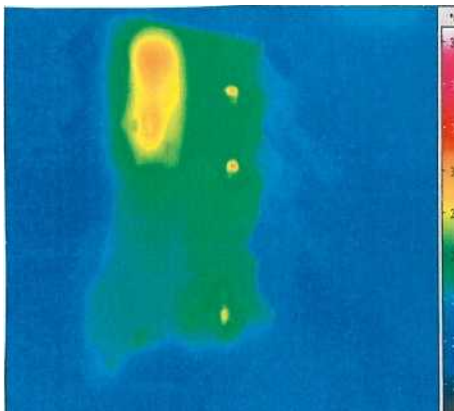

Precise transmission, long service life

– Patented circuit concepts ensure precise signal transmission and minimal self-heating.



Even for the Ex area

– Maximum explosion protection for all Ex zones with the MACX Analog Ex range.



Fast and error-free signal connection

– Compact termination carriers connect MACX Analog devices to the automation system – plug and play.

Analog IN / Analog OUT 3-way isolating amplifier

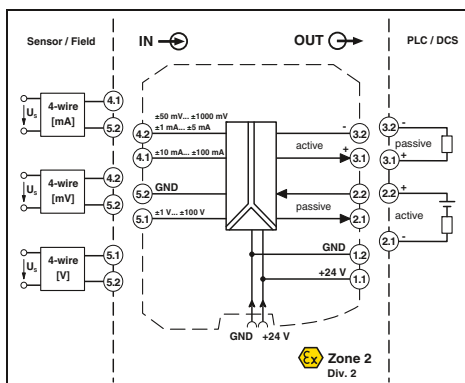
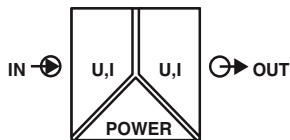

Ex n



SIL IEC 61508



**Universal,
more than 1600 signal combinations**

Functional safety
Ex: // Applied for: cUL / UL
Housing width 12.5 mm

Universal isolating amplifier for operating 4-conductor measuring transducers

- Analog isolating amplifier for isolating, filtering, amplifying, and converting standard analog signals
- Configurable input and output signals, including bipolar current and voltage signals
- 3-way electrical isolation
- Over 1600 signal conversions can be set via DIP switches on the front
- 10 kHz limit frequency for time-critical applications
- Output active or passive
- Plug-in capable screw or spring-cage connection method
- Power supply via DIN rail connector possible
- Status indicator for supply voltage
- Up to SIL 2 according to EN 61508
- Installation in zone 2 permissible

Notes:
To order a product with an order configuration, enter the required configuration by referring to the adjacent order key.
Information about the supply and error evaluation module as well as about the DIN rail connectors and marking material can be found from page 126
1) EMC: Class A product, see page 571

Input data
Input signal (configurable using the DIP switch)
Maximum input signal
Input resistance
Output data
Output signal (configurable using the DIP switch)
Load R_B
General data
Supply voltage U_B
Power dissipation
Maximum transmission error
Temperature coefficient
ZERO / SPAN adjustment
Limit frequency (3 dB)
Step response (10 - 90%)
Electrical isolation
Input/output/power supply
Degree of protection
Ambient temperature (operation)
Mounting
Housing material
Dimensions W / H / D
Screw connection solid / stranded / AWG
Spring-cage connection (solid/stranded/AWG)
Conformance / approvals
Conformance
ATEX
IECEX
UL, USA / Canada
Functional safety (SIL)
GL

Technical data	
U input	I input
0 ... 10 V, please indicate if different setting when ordering	
± 100 V	± 100 mA
Approx. 1 M Ω (± 1 V DC ... ± 100 V DC)	Approx. 10 Ω (± 10 mA DC ... ± 100 mA DC)
U output	I output
0 ... 20 mA, please indicate if different setting when ordering	
≥ 1 k Ω (10 V)	≤ 600 Ω (20 mA; active) (passive: $\leq (U_B - 2$ V) / I_{outmax})
12 V DC ... 24 V DC (-20% / +25%)	< 0.7 W (at 24 V DC / 20 mA)
< 0.1% (Compared to the final value)	0.0075%/K
$\pm 4\%$ / $\pm 4\%$	10 kHz (Can be switched to 30 Hz)
35 μ s (at 10 kHz)	11 ms (at 30 Hz)
2.5 kV (50 Hz, 1 min., test voltage)	300 V _{rms} (Rated insulation voltage, surge voltage category II; pollution degree 2, safe isolation as per EN 61010, EN 50178)
IP20	-20°C ... 70°C
Any	PA 66-FR
12.5 / 99 / 114.5 mm	0.2 ... 2.5 mm ² / 0.2 ... 2.5 mm ² / 24 - 14
0.2 ... 1.5 mm ² / 0.2 ... 1.5 mm ² / 24 - 16	
Ordering data	
CE-compliant	
II 3 G Ex nA IIC T4 Gc	
Ex nA IIC T4 Gc	
UL applied for	
SIL 2	
-	

Description
3-way isolating amplifier , for electrical isolation of analog signals
Order configuration
Order configuration
Standard configuration
Standard configuration

Type	Order No.	Pcs. / Pkt.
MACX MCR-UI-UI ¹⁾	2811284	1
MACX MCR-UI-UI-SP ¹⁾	2811572	1
MACX MCR-UI-UI-NC ¹⁾	2811446	1
MACX MCR-UI-UI-SP-NC ¹⁾	2811556	1

Isolating amplifiers with SIL functional safety - MACX Analog

Order key for MACX MCR-UI-UI... (standard configuration entered as an example)

Order No.	Input	Output	Limit frequency	Factory calibration certificate (FCC)			
2811284	IN03	OUT01	10K	NONE			
2811284 ≙ ...-UI-UI	IN40 ≙ 0...50 mV IN24 ≙ 0...60 mV IN41 ≙ 0...75 mV IN25 ≙ 0...100 mV IN43 ≙ 0...120 mV IN44 ≙ 0...150 mV IN26 ≙ 0...200 mV IN27 ≙ 0...300 mV IN28 ≙ 0...500 mV IN66 ≙ 0...1000 mV IN29 ≙ 0...1.0 V IN50 ≙ 0...1.5 V IN30 ≙ 0...2.0 V IN52 ≙ 0...3.0 V IN05 ≙ 0...5 V IN03 ≙ 0...10 V IN67 ≙ 0...15 V IN32 ≙ 0...20 V IN39 ≙ 0...30 V IN68 ≙ 0...50 V IN69 ≙ 0...100 V IN06 ≙ 1...5 V IN04 ≙ 2...10 V	IN53 ≙ -50...+50 mV IN13 ≙ -60...+60 mV IN54 ≙ -75...+75 mV IN14 ≙ -100...+100 mV IN56 ≙ -120...+120 mV IN57 ≙ -150...+150 mV IN15 ≙ -200...+200 mV IN16 ≙ -300...+300 mV IN17 ≙ -500...+500 mV IN78 ≙ -1000...+1000 mV IN18 ≙ -1.0...+1.0 V IN63 ≙ -1.5...+1.5 V IN19 ≙ -2.0...+2.0 V IN65 ≙ -3.0...+3.0 V IN21 ≙ -5...+5 V IN22 ≙ -10...+10 V IN79 ≙ -15...+15 V IN23 ≙ -20...+20 V IN80 ≙ -30...+30 V IN81 ≙ -50...+50 V IN82 ≙ -100...+100 V	IN70 ≙ 0...1.0 mA IN71 ≙ 0...1.5 mA IN72 ≙ 0...2.0 mA IN73 ≙ 0...3.0 mA IN36 ≙ 0...5 mA IN37 ≙ 0...10 mA IN74 ≙ 0...15 mA IN01 ≙ 0...20 mA IN75 ≙ 0...30 mA IN76 ≙ 0...50 mA IN77 ≙ 0...100 mA IN83 ≙ -1.0...+1.0 mA IN84 ≙ -1.5...+1.5 mA IN85 ≙ -2.0...+2.0 mA IN86 ≙ -3.0...+3.0 mA IN33 ≙ -5...+5 mA IN34 ≙ -10...+10 mA IN87 ≙ -15...+15 mA IN35 ≙ -20...+20 mA IN88 ≙ -30...+30 mA IN89 ≙ -50...+50 mA IN90 ≙ -100...+100 mA IN91 ≙ 1...5 mA IN92 ≙ 2...10 mA IN02 ≙ 4...20 mA	OUT19 ≙ 0...2.5 V OUT05 ≙ 0...5 V OUT03 ≙ 0...10 V OUT20 ≙ -2.5...+2.5 V OUT13 ≙ -5...+5 V OUT14 ≙ -10...+10 V OUT24 ≙ 0.5...+2.5 V OUT06 ≙ 1...5 V OUT04 ≙ 2...10 V OUT27 ≙ 2.5...0 V OUT11 ≙ 5...0 V OUT09 ≙ 10...0 V	OUT15 ≙ 0...5 mA OUT16 ≙ 0...10 mA OUT01 ≙ 0...20 mA OUT21 ≙ -5...+5 mA OUT22 ≙ -10...+10 mA OUT23 ≙ -20...+20 mA OUT25 ≙ 1...5 mA OUT26 ≙ 2...10 mA OUT02 ≙ 4...20 mA OUT28 ≙ 5...0 mA OUT29 ≙ 10...0 mA OUT07 ≙ 20...0 mA	30 ≙ 30 Hz 10K ≙ 10 kHz	NONE ≙ without FCC YES ≙ with FCC (a fee is charged) YESPLUS ≙ FCC with 5 measuring points (a fee is charged)

Application example: level measurement and active analog input card

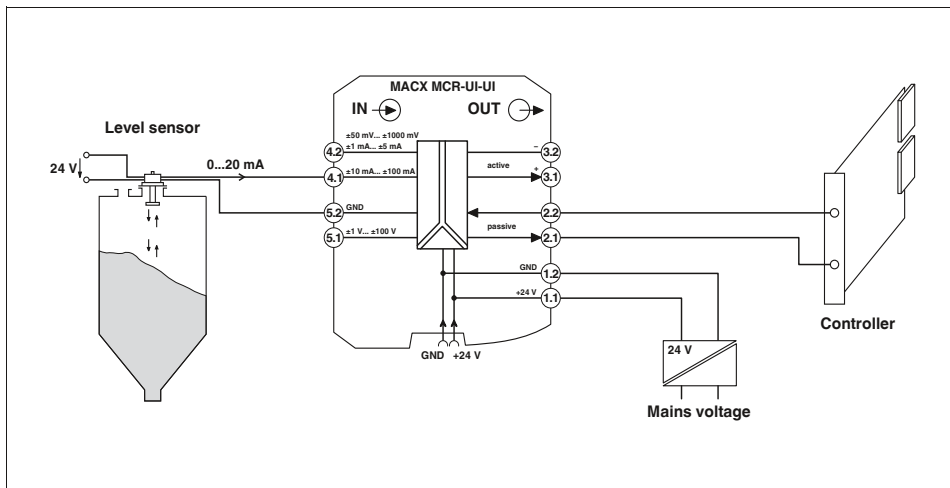

Application example: shunt measurement and Inline terminal with passive analog input channels within an Inline station

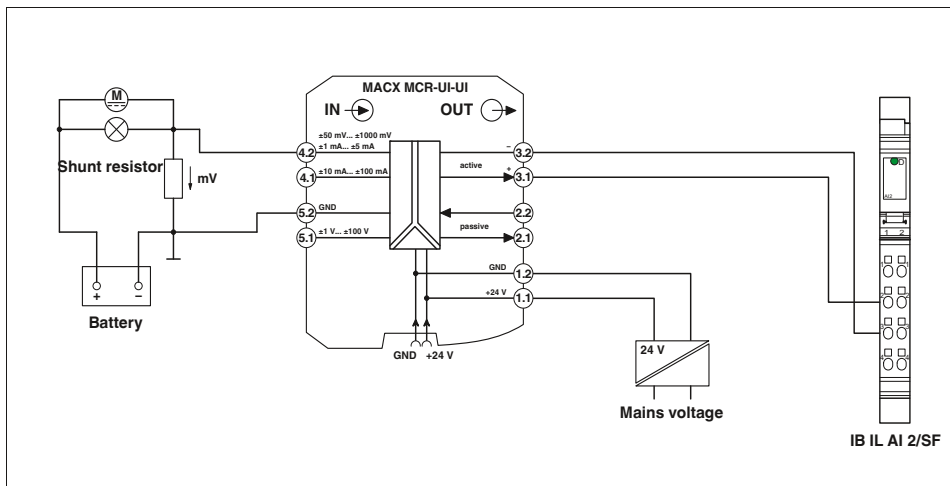

(Information on automation solutions from Phoenix Contact can be found in Catalog 8 or at www.phoenixcontact.net/products)

Analog IN / Analog OUT
3-way isolating amplifier

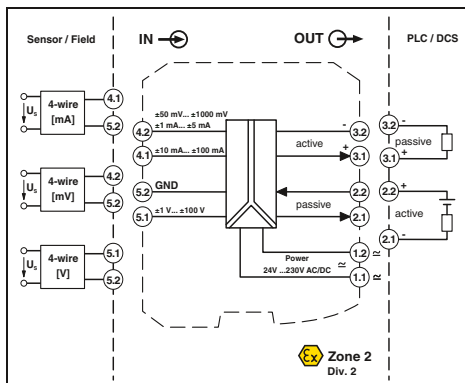
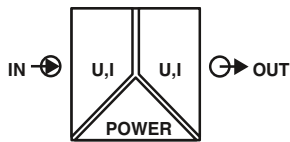

Ex n



Functional safety

Ex: Ex, Ex, Ex

Housing width 12.5 mm



Universal, more than 1600 signal combinations,
wide-range power supply

- Analog isolating amplifier for isolating, filtering, amplifying, and converting standard analog signals
- Configurable input and output signals, including bipolar current and voltage signals
- 3-way electrical isolation
- Over 1600 signal conversions can be set via DIP switches on the front
- Output active or passive
- Plug-in capable screw or spring-cage connection method
- Wide-range power supply: 19.2 ... 253 V AC/DC
- Status indicator for supply voltage
- Up to SIL 2 according to EN 61508
- Installation in zone 2 permissible

Notes:
To order a product with an order configuration, enter the required configuration by referring to the adjacent order key.
1) EMC: Class A product, see page 571

Input data	Input signal (configurable using the DIP switch)
Maximum input signal	±50 mV... ±1000 mV
Input resistance	±1 mA... ±5 mA
Output data	Output signal (configurable using the DIP switch)
Maximum output signal	±10 mA... ±100 mA
Load R _B	±1 V... ±100 V
General data	Supply voltage U _B
Power dissipation	24V ... 230V AC/DC
Maximum transmission error	±4% / ±4%
Temperature coefficient	0.0075%/K
ZERO / SPAN adjustment	±0.1% (Compared to the final value)
Electrical isolation	2.5 kV (50 Hz, 1 min., test voltage)
	300 V _{rms} (Rated insulation voltage, surge voltage category II; pollution degree 2, safe isolation as per EN 61010, EN 50178)
Degree of protection	IP20
Ambient temperature (operation)	-20°C ... 70°C
Housing material	PA 66-FR
Dimensions W / H / D	12.5 / 99 / 114.5 mm
Screw connection solid / stranded / AWG	0.2 ... 2.5 mm ² / 0.2 ... 2.5 mm ² / 24 - 14
Spring-cage connection (solid/stranded/AWG)	0.2 ... 1.5 mm ² / 0.2 ... 1.5 mm ² / 24 - 16
Conformance / approvals	CE-compliant
Conformance	Ex II 3 G Ex nA IIC T4 Gc
ATEX	Ex nA IIC T4 Gc
IECEX	-
UL, USA / Canada	-
Functional safety (SIL)	SIL 2
GL	-

Technical data

U input	I input
0 ... 10 V, please indicate if different setting when ordering	
±100 V	±100 mA
Approx. 1 MΩ	Approx. 10 Ω
(±1 V DC ... ±100 V DC)	(±10 mA DC ... ±100 mA DC)
U output	I output
0 ... 20 mA, configurable via DIP switches	
15 V	35 mA
≥ 1 kΩ (10 V)	≤ 600 Ω (20 mA; active)
	(passive: ≤ (U _B -2 V) / I _{outmax})
Input/output/power supply	
	2.5 kV (50 Hz, 1 min., test voltage)
	300 V _{rms} (Rated insulation voltage, surge voltage category II; pollution degree 2, safe isolation as per EN 61010, EN 50178)
	IP20
	-20°C ... 70°C
	PA 66-FR
	12.5 / 99 / 114.5 mm
	0.2 ... 2.5 mm ² / 0.2 ... 2.5 mm ² / 24 - 14
	0.2 ... 1.5 mm ² / 0.2 ... 1.5 mm ² / 24 - 16
	CE-compliant
	Ex II 3 G Ex nA IIC T4 Gc
	Ex nA IIC T4 Gc
	-
	SIL 2
	-

Ordering data

Description		Type	Order No.	Pcs. / Pkt.
3-way isolating amplifier , for electrical isolation of analog signals with long-range power supply				
Order configuration	Screw connection	MACX MCR-UI-UI-UP¹⁾	2811459	1
Order configuration	Spring-cage connection	MACX MCR-UI-UI-UP-SP¹⁾	2811585	1
Standard configuration	Screw connection	MACX MCR-UI-UI-UP-NC¹⁾	2811297	1
Standard configuration	Spring-cage connection	MACX MCR-UI-UI-UP-SP-NC¹⁾	2811569	1

Isolating amplifiers with SIL functional safety - MACX Analog

Order key for MACX MCR-UI-UI-... (standard configuration entered as an example)

Order No.	Input	Output	Limit frequency	Factory calibration certificate (FCC)			
2811459	IN03	OUT01	10K	NONE			
2811459 ≙ ...-UI-UI-UP	IN40 ≙ 0...50 mV IN24 ≙ 0...60 mV IN41 ≙ 0...75 mV IN25 ≙ 0...100 mV IN43 ≙ 0...120 mV IN44 ≙ 0...150 mV IN26 ≙ 0...200 mV IN27 ≙ 0...300 mV IN28 ≙ 0...500 mV IN66 ≙ 0...1000 mV IN29 ≙ 0...1.0 V IN50 ≙ 0...1.5 V IN30 ≙ 0...2.0 V IN52 ≙ 0...3.0 V IN05 ≙ 0...5 V IN03 ≙ 0...10 V IN67 ≙ 0...15 V IN32 ≙ 0...20 V IN39 ≙ 0...30 V IN68 ≙ 0...50 V IN69 ≙ 0...100 V IN06 ≙ 1...5 V IN04 ≙ 2...10 V	IN53 ≙ -50...+50 mV IN13 ≙ -60...+60 mV IN54 ≙ -75...+75 mV IN14 ≙ -100...+100 mV IN56 ≙ -120...+120 mV IN57 ≙ -150...+150 mV IN15 ≙ -200...+200 mV IN16 ≙ -300...+300 mV IN17 ≙ -500...+500 mV IN78 ≙ -1000...+1000 mV IN18 ≙ -1.0...+1.0 V IN63 ≙ -1.5...+1.5 V IN19 ≙ -2.0...+2.0 V IN65 ≙ -3.0...+3.0 V IN21 ≙ -5...+5 V IN22 ≙ -10...+10 V IN79 ≙ -15...+15 V IN23 ≙ -20...+20 V IN80 ≙ -30...+30 V IN81 ≙ -50...+50 V IN82 ≙ -100...+100 V	IN70 ≙ 0...1.0 mA IN71 ≙ 0...1.5 mA IN72 ≙ 0...2.0 mA IN73 ≙ 0...3.0 mA IN36 ≙ 0...5 mA IN37 ≙ 0...10 mA IN74 ≙ 0...15 mA IN01 ≙ 0...20 mA IN75 ≙ 0...30 mA IN76 ≙ 0...50 mA IN77 ≙ 0...100 mA IN83 ≙ -1.0...+1.0 mA IN84 ≙ -1.5...+1.5 mA IN85 ≙ -2.0...+2.0 mA IN86 ≙ -3.0...+3.0 mA IN33 ≙ -5...+5 mA IN34 ≙ -10...+10 mA IN87 ≙ -15...+15 mA IN35 ≙ -20...+20 mA IN88 ≙ -30...+30 mA IN89 ≙ -50...+50 mA IN90 ≙ -100...+100 mA IN91 ≙ 1...5 mA IN92 ≙ 2...10 mA IN02 ≙ 4...20 mA	OUT19 ≙ 0...2.5 V OUT05 ≙ 0...5 V OUT03 ≙ 0...10 V OUT20 ≙ -2.5...+2.5 V OUT13 ≙ -5...+5 V OUT14 ≙ -10...+10 V OUT24 ≙ 0.5...+2.5 V OUT06 ≙ 1...5 V OUT04 ≙ 2...10 V OUT27 ≙ 2.5...0 V OUT11 ≙ 5...0 V OUT09 ≙ 10...0 V	OUT15 ≙ 0...5 mA OUT16 ≙ 0...10 mA OUT01 ≙ 0...20 mA OUT21 ≙ -5...+5 mA OUT22 ≙ -10...+10 mA OUT23 ≙ -20...+20 mA OUT25 ≙ 1...5 mA OUT26 ≙ 2...10 mA OUT02 ≙ 4...20 mA OUT28 ≙ 5...0 mA OUT29 ≙ 10...0 mA OUT07 ≙ 20...0 mA	30 ≙ 30 Hz 10K ≙ 10 kHz	NONE ≙ without FCC YES ≙ with FCC (a fee is charged) YESPLUS ≙ FCC with 5 measuring points (a fee is charged)

Application example: level measurement and active analog input card

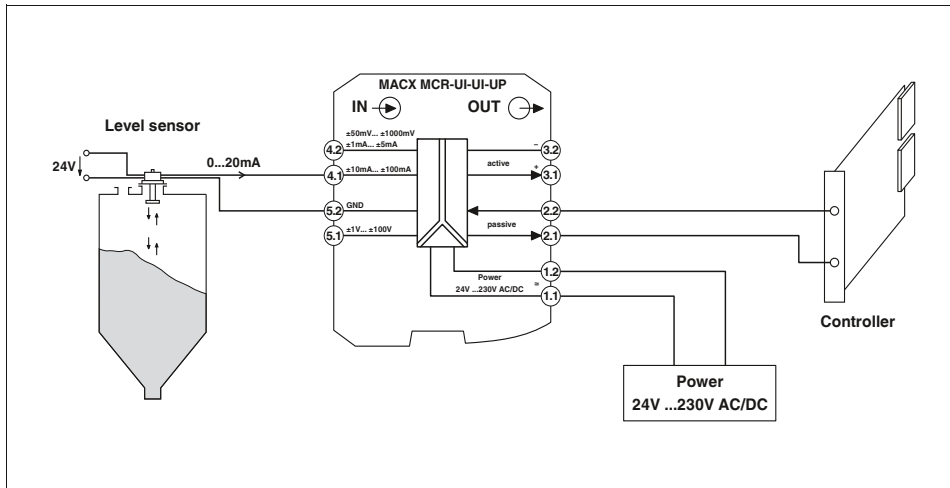

Application example: shunt measurement and Inline terminal with analog input channels within an Inline station

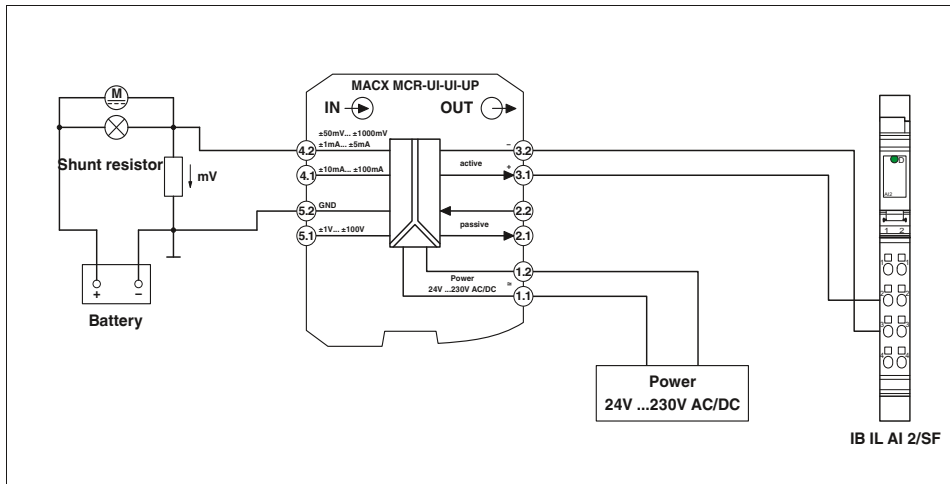

(Information on automation solutions from Phoenix Contact can be found in Catalog 8 or at www.phoenixcontact.net/products)

Analog IN / Analog OUT repeater power supplies

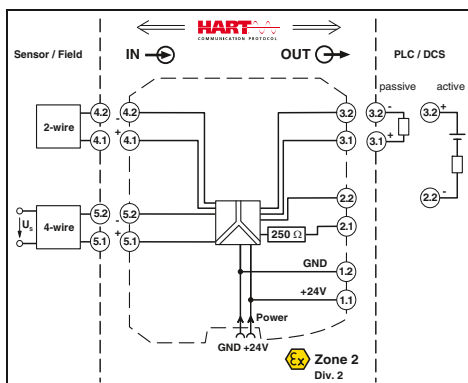
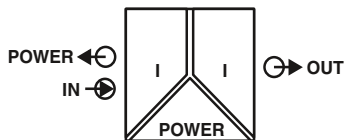

Ex n



Repeater power supply and input isolating amplifier

Functional safety

Ex: Ex

Housing width 12.5 mm

Technical data

Repeater power supply and input isolating amplifier for the operation of 2-conductor measuring transducers, 4-conductor measuring transducers, and mA current sources

- Input 0/4...20 mA (feeding or non-feeding)
- 0/4...20 mA output (active or passive)
- Bidirectional transmission of digital HART communication signals
- Plug-in capable screw or spring-cage connection method, with integrated sockets for HART communicators
- Terminal point with 250 Ω resistor to increase the HART impedance in the case of low-impedance systems
- 3-way electrical isolation
- Power supply via DIN rail connector possible
- Up to SIL 2 according to EN 61508
- Installation in zone 2 permitted

Input data

Input signal
Transmitter supply voltage
Voltage drop

Output data

Output signal

Load

Output ripple

General data

Supply voltage range
Current consumption
Power dissipation
Temperature coefficient
Step response (10 - 90%)
Transmission error, typical
Maximum transmission error
Under-/overload range
Electrical isolation

Input/output/power supply

Ambient temperature range

Status indication
SMART communication
Signal bandwidth
Protocols supported
Housing material
Dimensions W / H / D
Screw connection solid / stranded / AWG
Spring-cage connection (solid/stranded/AWG)
Conformance / approvals
Conformance
ATEX
UL, USA / Canada
Functional safety (SIL)

0 mA ... 20 mA / 4 mA ... 20 mA
> 16 V (at 20 mA)
< 3.5 V (in input isolating amplifier operation)

0 mA ... 20 mA (active)
4 mA ... 20 mA (active)
0 mA ... 20 mA (14 ... 26 V ext. source voltage)
4 mA ... 20 mA (14 ... 26 V ext. source voltage)
< 600 Ω
< 20 mV_{rms}

19.2 V DC ... 30 V DC
< 60 mA (at 24 V DC)
< 1.1 W (at 24 V DC / 20 mA)
< 0.01%/K
< 600 μs (for 4 mA ... 20 mA step)
< 0.05% (of final value)
< 0.1% (of final value)
as per NE 43

2.5 kV (50 Hz, 1 min., test voltage)
300 V_{rms} (Rated insulation voltage, surge voltage category II; pollution degree 2, safe isolation as per EN 61010, EN 50178)

-20°C ... 60°C (Any mounting position)
Green LED (supply voltage)

Yes
as per HART specifications

HART
PA 66-FR
12.5 / 99 / 114.5 mm
0.2 ... 2.5 mm² / 0.2 ... 2.5 mm² / 24 - 14
0.2 ... 1.5 mm² / 0.2 ... 1.5 mm² / 24 - 16

CE-compliant, additionally EN 61326
Ex II 3 G Ex nA IIC T4 Gc X
UL applied for
SIL 2 according to EN 61508

Ordering data

Notes:
Information about the supply and error evaluation module as well as about the DIN rail connectors and marking material can be found from page 126
Test plugs for test sockets can be found on page 191
Information on "Plug and play" connection using system cabling can be found from page 128
1) EMC: Class A product, see page 571

Description

Repeater power supply, with HART® protocol

Screw connection
Spring-cage conn.

Type	Order No.	Pcs. / Pkt.
MACX MCR-SL-RPSSI-I1)	2865955	1
MACX MCR-SL-RPSSI-I-SP1)	2924207	1

Analog IN / Analog OUT
repeater power supplies

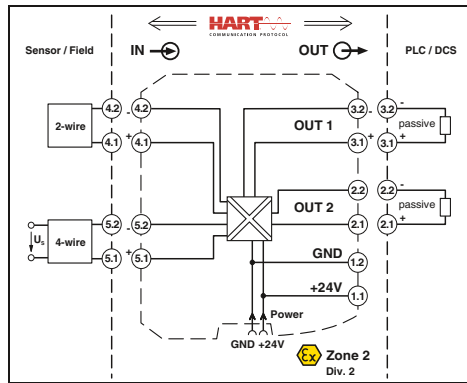
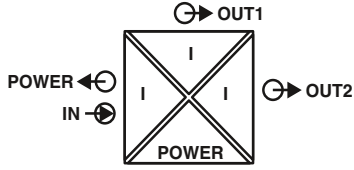

Repeater power supply and input isolating amplifier, with two electrically isolated outputs

Functional safety
Ex: Ex n
Housing width 12.5 mm

Repeater power supply and input isolating amplifier for the operation of 2-conductor measuring transducers, 4-conductor measuring transducers, and mA current sources

- Input 0/4...20 mA (feeding or non-feeding)
- Two electrically isolated 0/4 ... 20 mA (active) outputs
- Bidirectional transmission of digital HART communication signals (both outputs)
- Plug-in capable screw or spring-cage connection method, with integrated sockets for HART communicators
- 4-way electrical isolation
- Power supply via DIN rail connector possible
- Up to SIL 2 according to EN 61508
- Installation in zone 2 permitted

Input data

Input signal
Transmitter supply voltage
Voltage drop

Output data

Output signal (Per output)

Load

Output ripple

General data

Supply voltage range
Current consumption
Power dissipation
Temperature coefficient
Step response (10 - 90%)
Transmission error, typical
Maximum transmission error
Under-/overload range
Electrical isolation

Input/output/power supply

Output 1/output 2

Ambient temperature range
Status indication
SMART communication (Per output)
Protocols supported
Housing material
Dimensions W / H / D
Screw connection solid / stranded / AWG
Spring-cage connection (solid/stranded/AWG)
Conformance / approvals
Conformance
ATEX
Functional safety (SIL)

Technical data

4 mA ... 20 mA / 0 mA ... 20 mA
> 21.5 V (at 20 mA)
< 3.9 V (in input isolating amplifier operation)

0 mA ... 20 mA (active)
4 mA ... 20 mA (active)
< 450 Ω (at 20 mA)
< 20 mV_{rms}

19.2 V DC ... 30 V DC (24 V DC (-20% ... +25%))
< 75 mA (at 24 V DC)
< 1.45 W (at 24 V DC / 20 mA)
< 0.01%/K
< 1.3 ms (for 4 mA ... 20 mA step)
< 0.05% (of final value)
< 0.1% (of final value)
as per NE 43

2.5 kV (50 Hz, 1 min., test voltage)
300 V_{rms} (Rated insulation voltage, surge voltage category II; pollution degree 2, safe isolation as per EN 61010, EN 50178)

1.5 kV AC (50 Hz, 1 min., test voltage)
-20°C ... 60°C (Any mounting position)
Green LED (PWR supply voltage)
Yes
HART
PA 66-FR
12.5 / 99 / 114.5 mm
0.2 ... 2.5 mm² / 0.2 ... 2.5 mm² / 24 - 14
0.2 ... 1.5 mm² / 0.2 ... 1.5 mm² / 24 - 16

CE-compliant, additionally EN 61326
Ex II 3 G Ex nA IIC T4 Gc X
SIL 2 according to EN 61508

Notes:

Information about the supply and error evaluation module as well as about the DIN rail connectors and marking material can be found from page 126

Test plugs for test sockets can be found on page 191

Information on "Plug and play" connection using system cabling can be found from page 128

1) EMC: Class A product, see page 571

Ordering data

Description

Repeater power supply, with HART® protocol

Screw connection
Spring-cage conn.

Type

MACX MCR-SL-RPSSI-2I¹⁾
MACX MCR-SL-RPSSI-2I-SP¹⁾

Order No.

2924825
2924838

Pcs. / Pkt.

1
1

Analog IN / Analog OUT
repeater power supplies

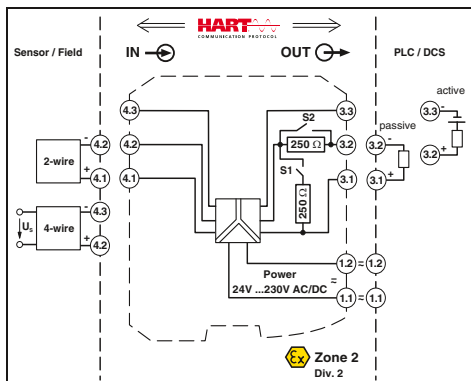
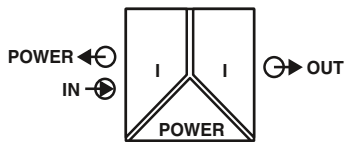

Ex n



Repeater power supply and input isolating amplifier, wide-range power supply

Functional safety
Ex: Ex
Housing width 17.5 mm

Repeater power supply and input isolating amplifier for the operation of 2-conductor measuring transducers, 4-conductor measuring transducers, and mA current sources

- Input 0/4...20 mA (feeding or non-feeding)
- Output 0/4...20 mA (active or passive), 0/1...5 V, can be switched via the DIP switch
- Bidirectional transmission of digital HART communication signals
- Plug-in capable screw or spring-cage connection method, with integrated sockets for HART communicators
- 250 Ω resistor that can be activated via DIP switches to increase the HART impedance in the case of low-impedance systems
- 3-way electrical isolation
- Wide-range power supply: 19.2 ... 253 V AC/DC
- Up to SIL 2 according to EN 61508
- Installation in zone 2 permitted

Input data

Input signal
Transmitter supply voltage
Voltage drop

Output data

Output signal

Load

Output ripple

General data

Supply voltage range
Current consumption
Power dissipation
Temperature coefficient
Step response (10 - 90%)
Transmission error, typical
Maximum transmission error
Under-/overload range
Electrical isolation

Input/output/power supply

Ambient temperature range
Status indication
SMART communication
Signal bandwidth
Protocols supported
Housing material
Dimensions W / H / D
Screw connection solid / stranded / AWG
Spring-cage connection (solid/stranded/AWG)
Conformance / approvals
Conformance
ATEX
UL, USA / Canada
Functional safety (SIL)

Technical data

0 mA ... 20 mA / 4 mA ... 20 mA
> 16 V (at 20 mA)
< 3.5 V (in input isolating amplifier operation)

0 mA ... 20 mA (active)
4 mA ... 20 mA (active)
0 mA ... 20 mA (14 ... 26 V ext. source voltage)
4 mA ... 20 mA (14 ... 26 V ext. source voltage)
0 V ... 5 V (internal resistance, 250 Ω, 0.1%)
1 V ... 5 V (internal resistance, 250 Ω, 0.1%)
< 600 Ω (I output)
< 20 mV_{rms}

24 V ... 230 V AC/DC (-20%/+10%, 50/60 Hz)
< 75 mA (at 24 V DC)
< 1.8 W
< 0.01%/K
< 600 μs (for 4 mA ... 20 mA step)
< 0.05% (of final value)
< 0.1% (of final value)
as per NE 43

2.5 kV (50 Hz, 1 min., test voltage)
300 V_{rms} (Rated insulation voltage, surge voltage category II; pollution degree 2, safe isolation as per EN 61010, EN 50178)

-20°C ... 60°C (Any mounting position)
Green LED (supply voltage)
Yes
as per HART specifications
HART
PA 66-FR
17.5 / 99 / 114.5 mm
0.2 ... 2.5 mm² / 0.2 ... 2.5 mm² / 24 - 14
0.2 ... 1.5 mm² / 0.2 ... 1.5 mm² / 24 - 16

CE-compliant, additionally EN 61326
Ex II 3 G Ex nA IIC T4 Gc X
UL applied for
SIL 2 according to EN 61508

Notes:

Information about the supply and error evaluation module as well as about the DIN rail connectors and marking material can be found from page 126

Test plugs for test sockets can be found on page 191

1) EMC: Class A product, see page 571

Ordering data

Description
Repeater power supply, with HART® protocol
Screw connection
Spring-cage conn.

Type	Order No.	Pcs. / Pkt.
MACX MCR-SL-RPSSH-UP ¹⁾	2865968	1
MACX MCR-SL-RPSSI-I-UP-SP ¹⁾	2924210	1

Analog OUT
output isolating amplifier

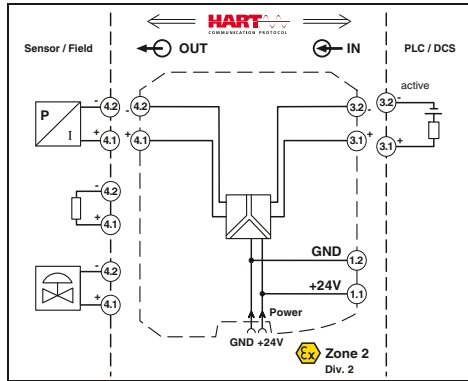
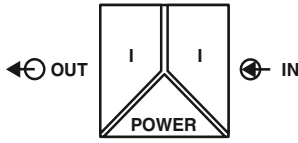

Functional safety
Ex:
Housing width 12.5 mm

Output isolating amplifier for controlling I/P transducers, control valves, and displays

- 0/4 ... 20 mA input
- 0/4 ... 20 mA output
- Bidirectional transmission of digital HART communication signals
- Plug-in capable screw or spring-cage connection method, with integrated sockets for HART communicators
- Line fault detection (LF)
- 3-way electrical isolation
- Power supply via DIN rail connector possible
- Up to SIL 2 according to EN 61508
- Installation in zone 2 permitted

Notes:
Information about the supply and error evaluation module as well as about the DIN rail connectors and marking material can be found from page 126
Test plugs for test sockets can be found on page 191
Information on "Plug and play" connection using system cabling can be found from page 128
1) EMC: Class A product, see page 571

Input data	Input signal Input voltage Input impedance in the event of a cable break at the output
Output data	Output signal Load Output ripple
General data	Supply voltage range Current consumption Power dissipation Temperature coefficient Step response (10 - 90%) Maximum transmission error Electrical isolation
Input/output/power supply	1.5 kV (50 Hz, 1 min., test voltage) 300 V _{rms} (Rated insulation voltage, surge voltage category II; pollution degree 2, safe isolation as per EN 61010, EN 50178)
Ambient temperature range	-20°C ... 60°C (Any mounting position)
Humidity	10% ... 95% (no condensation)
SMART communication	Yes
Signal bandwidth	as per HART specifications
Protocols supported	HART
Housing material	PA 66-FR
Inflammability class according to UL 94	V0
Dimensions W / H / D	12.5 / 99 / 114.5 mm
Screw connection solid / stranded / AWG	0.2 ... 2.5 mm ² / 0.2 ... 2.5 mm ² / 24 - 14
Spring-cage connection (solid/stranded/AWG)	0.2 ... 1.5 mm ² / 0.2 ... 1.5 mm ² / 24 - 16
Conformance / approvals	CE-compliant, additionally EN 61326 II 3 G Ex nA IIC T4 Gc X SIL 2 according to EN 61508
Conformance	
ATEX	
Functional safety (SIL)	

Technical data

Input data	0 mA ... 20 mA / 4 mA ... 20 mA 5.4 V (at 20 mA) > 100 kΩ (if there is a line fault)
Output data	0 mA ... 20 mA / 4 mA ... 20 mA < 800 Ω (at 20 mA) < 20 mV _{rms}
General data	19.2 V DC ... 30 V DC < 46 mA (at 24 V DC / 20 mA) < 1.1 W (at 24 V DC / 20 mA) < 0.01%/K < 140 μs < 0.1% (of final value)
Input/output/power supply	1.5 kV (50 Hz, 1 min., test voltage) 300 V _{rms} (Rated insulation voltage, surge voltage category II; pollution degree 2, safe isolation as per EN 61010, EN 50178)
Ambient temperature range	-20°C ... 60°C (Any mounting position)
Humidity	10% ... 95% (no condensation)
SMART communication	Yes
Signal bandwidth	as per HART specifications
Protocols supported	HART
Housing material	PA 66-FR
Inflammability class according to UL 94	V0
Dimensions W / H / D	12.5 / 99 / 114.5 mm
Screw connection solid / stranded / AWG	0.2 ... 2.5 mm ² / 0.2 ... 2.5 mm ² / 24 - 14
Spring-cage connection (solid/stranded/AWG)	0.2 ... 1.5 mm ² / 0.2 ... 1.5 mm ² / 24 - 16
Conformance / approvals	CE-compliant, additionally EN 61326 II 3 G Ex nA IIC T4 Gc X SIL 2 according to EN 61508
Conformance	
ATEX	
Functional safety (SIL)	

Ordering data

Description	Type	Order No.	Pcs. / Pkt.
Output isolating amplifier			
Screw connection	MACX MCR-SL-IDS-I ¹⁾	2865971	1
Spring-cage conn.	MACX MCR-SL-IDS-I-SP ¹⁾	2924223	1

Temperature Temperature transducer

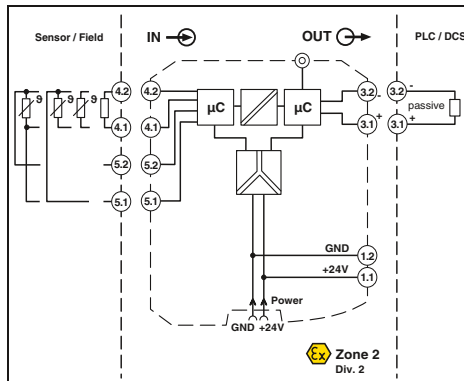
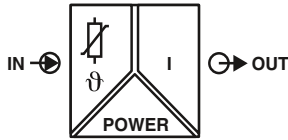

For resistance thermometers and resistance-type sensors



Housing width 12.5 mm

Programmable temperature transducer for operating resistance thermometers and resistance-type sensors. The measured values are converted into a linear 0 ... 20 mA or 4 ... 20 mA signal.

- Input for resistance thermometers and resistance-type sensors
- 0 ... 20 mA or 4 ... 20 mA output
- Configuration via software (FDT/DTM): Sensor type, connection method, measuring range, measuring unit, filter, alarm signal, and output range
- Programming during operation and also voltage-free using IFS-USB-PROG-ADAPTER programming adapter
- Status indicator for supply voltage, cable, sensor, and module errors
- 3-way electrical isolation
- Power supply via DIN rail connector possible
- Up to SIL 2 according to EN 61508
- Installation in zone 2 permitted

Input data

Resistance thermometers
Resistor
Cable resistance
Sensor input current
Measuring range span

Output data

Output signal
Load
Behavior in the event of a sensor error
Output ripple

General data

Supply voltage range
Current consumption
Power dissipation
Temperature coefficient
Step response (0 - 99%)

Transmission error, total

ZERO / SPAN adjustment
Electrical isolation

Input/output/power supply

Ambient temperature range
Humidity
Housing material
Inflammability class according to UL 94
Dimensions W / H / D
Screw connection solid / stranded / AWG
Spring-cage connection (solid/stranded/AWG)

Conformance / approvals

Conformance
ATEX
Functional safety (SIL)

Technical data

Pt, Ni, Cu sensors: 2, 3, 4-conductor
0 Ω ... 2000 Ω
50 Ω per line
(200 µA ... 1 mA)
min. 50 K

0 mA ... 20 mA / 4 mA ... 20 mA
≤ 500 Ω
As per NE 43 or can be freely defined
< 50 µA_{PP}

19.2 V DC ... 30 V DC
< 40 mA (24 V DC)
< 1 W
0.01%/K
Typ. 800 ms (With SIL)
max. 1200 ms (With SIL)
Typ. 700 ms (Without SIL)
max. 1100 ms (Without SIL)
0.05% x 100 [K] / measuring range span [K] + 0.05%

±5% / ±5%

2.5 kV (50 Hz, 1 min., test voltage)
300 V_{ins} (Rated insulation voltage, surge voltage category II; pollution degree 2, safe isolation as per EN 61010, EN 50178)

-20°C ... 60°C (Any mounting position)
5% ... 95% (no condensation)
PA 66-FR
V0
12.5 / 99 / 114.5 mm
0.2 ... 2.5 mm² / 0.2 ... 2.5 mm² / 24 - 14
0.2 ... 1.5 mm² / 0.2 ... 1.5 mm² / 24 - 16

CE-compliant, additionally EN 61326
Ex II 3 G Ex nA ic IIC T4 Gc X
SIL 2 according to EN 61508

Ordering data

Type	Order No.	Pcs. / Pkt.
MACX MCR-SL-RTD-I ¹⁾	2865065	1
MACX MCR-SL-RTD-I-SP ¹⁾	2924317	1
MACX MCR-SL-RTD-I-NC ¹⁾	2865078	1
MACX MCR-SL-RTD-I-SP-NC ¹⁾	2924320	1

Accessories

IFS-USB-PROG-ADAPTER ¹⁾	2811271	1
------------------------------------	---------	---

Notes:
To order a product with an order configuration, enter the required configuration by referring to the adjacent order key.
The configuration software can be downloaded from the Internet (www.phoenixcontact.net/products).
Information about the supply and error evaluation module as well as about the DIN rail connectors and marking material can be found from page 126
For information on the programming adapter, refer to page 119
Test plugs for test sockets can be found on page 191
Information on "Plug and play" connection using system cabling can be found from page 128
1) EMC: Class A product, see page 571

Description

Temperature transducer

Order configuration	Screw connection
Order configuration	Spring-cage conn.
Standard configuration	Screw connection
Standard configuration	Spring-cage conn.

Programming adapter for configuring modules with S-PORT interface

Order key and temperature ranges for MACX-MCR-SL-RTD-I(-SP) temperature transducer

Order key for MACX-MCR-SL-RTD-I(-SP) temperature transducer (standard configuration entered as an example)

Order No.	Sensor type	Safety integrity level (SIL)	Connection technology	Measuring range:		Measuring unit	Output range	Filter Oversampling	Filter Moving average value
				Start	End				
2865065	PT100	ON	3	0	100	C	OUT02	10	1
2865065 ≙ MACX MCR-SL-RTD-I	see below	ON ≙ active NONE ≙ not active	2 ≙ 2-conductor 3 ≙ 3-conductor 4 ≙ 4-conductor	see below	see below	C ≙ °C F ≙ °F O ≙ Ω	OUT01 ≙ 0...20 mA OUT02 ≙ 4...20 mA	1 ≙ 1 value 3 ≙ 3 values 5 ≙ 5 values 7 ≙ 7 values 10 ≙ 10 values 20 ≙ 20 values	1 ≙ 1 value 2 ≙ 2 values 3 ≙ 3 values 4 ≙ 4 values
2924317 ≙ MACX MCR-SL-RTD-I-SP		ON only with output range = OUT02							
				Smallest measuring range span					
	RES01	≙ Resistor		0	2000	Ω	25 Ω		
	PT50	≙ Pt 50 acc. to IEC 751		-200	850	°C	50 K		
	PT100	≙ Pt 100 acc. to IEC 751		-200	850	°C	50 K		
	PT200	≙ Pt 200 acc. to IEC 751		-200	850	°C	50 K		
	PT500	≙ Pt 500 acc. to IEC 751		-200	850	°C	50 K		
	PT100S	≙ Pt 100 acc. to Sama RC21-4-1966		-200	600	°C	50 K		
	PT500S	≙ Pt 500 acc. to Sama RC21-4-1966		-200	600	°C	50 K		
	NI100DIN	≙ Ni 100 acc. to DIN 43760		-60	250	°C	50 K		
	NI500DIN	≙ Ni 500 acc. to DIN 43760		-60	250	°C	50 K		
	CU50	≙ Cu 50 acc. to GOST 6651-2009 (α = 0.00428)		-50	200	°C	50 K		
	CU53	≙ Cu 53 acc. to GOST 6651-2009 (α = 0.00426)		-50	180	°C	50 K		

Alarm signal
Short circuit/
overrange

Alarm signal
Sensor break/
underrange

Factory calibration certificate = FCC

I035	I215	NONE
I000 ≙ 0 mA I035 ≙ 3.5 mA I215 ≙ 21.5 mA	I000 ≙ 0 mA I035 ≙ 3.5 mA I215 ≙ 21.5 mA	NONE ≙ without FCC YES ≙ with FCC (a fee is charged) YESPLUS ≙ FCC with 5 measuring points (a fee is charged)
I035 only with output range = OUT02		
Alarm signals can also be configured individually using software.		

Temperature conversion guide for °C to °F:

$$T [°F] = \frac{9}{5} T [°C] + 32$$

Temperature Temperature transducer

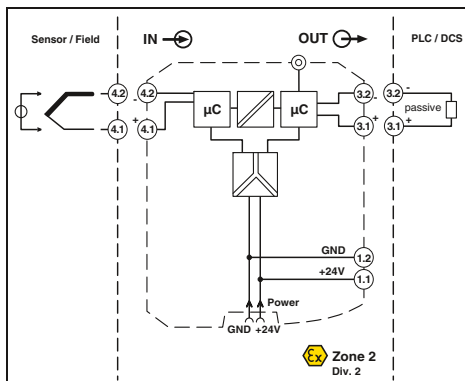
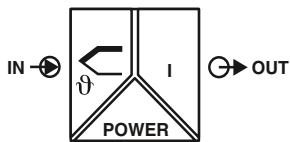

Ex n



For thermocouples and mV sources



Housing width 12.5 mm

Programmable temperature transducer for operating thermocouples and mV sources. The measured values are converted into a linear 0 ... 20 or 4 ... 20 mA signal.

- Input for thermocouples and mV sources
- 0 ... 20 mA or 4 ... 20 mA output
- Configuration via software (FDT/DTM): Sensor type, connection method, measuring range, measuring unit, filter, alarm signal, and output range
- Programming during operation and also voltage-free using IFS-USB-PROG-ADAPTER programming adapter
- Status indicator for supply voltage, cable, sensor, and module errors
- 3-way electrical isolation
- Power supply via DIN rail connector possible
- Up to SIL 2 according to EN 61508
- Installation in zone 2 permitted

Notes:
To order a product with an order configuration, enter the required configuration by referring to the adjacent order key.
The configuration software can be downloaded from the Internet (www.phoenixcontact.net/products).
Information about the supply and error evaluation module as well as about the DIN rail connectors and marking material can be found from page 126
For information on the programming adapter, refer to page 119
Information on "Plug and play" connection using system cabling can be found from page 128
1) EMC: Class A product, see page 571

Input data	Thermocouple sensors
Voltage	-20 mV ... 70 mV
Measuring range span	(Min. 50 K for thermocouples, 3 mV for mV sources)
Output data	0 mA ... 20 mA / 4 mA ... 20 mA
Output signal	max. 500 Ω
Load	As per NE 43 or can be freely defined
Behavior in the event of a sensor error	< 50 µA _{pp}
Output ripple	
General data	
Supply voltage range	19.2 V DC ... 30 V DC
Current consumption	< 40 mA (24 V DC)
Power dissipation	< 1 W
Temperature coefficient	0.01%/K
Step response (0 - 99%)	Typ. 800 ms (With SIL) max. 1200 ms (With SIL) Typ. 700 ms (Without SIL) max. 1100 ms (Without SIL)
Transmission error, total	0.05% x 200 [K]/Measuring range span [K] + 0.05%
Cold junction errors	±1 K
ZERO / SPAN adjustment	±5% / ±5%
Electrical isolation	
Input/output/power supply	2.5 kV (50 Hz, 1 min., test voltage) 300 V _{ins} (Rated insulation voltage, surge voltage category II; pollution degree 2, safe isolation as per EN 61010, EN 50178)
Ambient temperature range	-20°C ... 60°C (Any mounting position)
Humidity	5% ... 95% (no condensation)
Housing material	PA 66-FR
Inflammability class according to UL 94	V0
Dimensions W / H / D	12.5 / 99 / 114.5 mm
Screw connection solid / stranded / AWG	0.2 ... 2.5 mm ² / 0.2 ... 2.5 mm ² / 24 - 14
Conformance / approvals	
Conformance	CE-compliant, additionally EN 61326
ATEX	Ex II 3 G Ex nA ic IIC T4 Gc X
Functional safety (SIL)	SIL 2 according to EN 61508

Description	Temperature transducer
Order configuration	Screw connection
Standard configuration	Screw connection

Programming adapter for configuring modules with S-PORT interface
--

Technical data

E, J, K, N as per IEC / EN 60584, L as per DIN 43760

-20 mV ... 70 mV
(Min. 50 K for thermocouples, 3 mV for mV sources)

0 mA ... 20 mA / 4 mA ... 20 mA
max. 500 Ω

As per NE 43 or can be freely defined
< 50 µA_{pp}

19.2 V DC ... 30 V DC
< 40 mA (24 V DC)
< 1 W
0.01%/K
Typ. 800 ms (With SIL)
max. 1200 ms (With SIL)
Typ. 700 ms (Without SIL)
max. 1100 ms (Without SIL)

0.05% x 200 [K]/Measuring range span [K] + 0.05%

±1 K
±5% / ±5%

2.5 kV (50 Hz, 1 min., test voltage)
300 V_{ins} (Rated insulation voltage, surge voltage category II; pollution degree 2, safe isolation as per EN 61010, EN 50178)

-20°C ... 60°C (Any mounting position)

5% ... 95% (no condensation)

PA 66-FR

V0

12.5 / 99 / 114.5 mm

0.2 ... 2.5 mm² / 0.2 ... 2.5 mm² / 24 - 14

CE-compliant, additionally EN 61326

Ex II 3 G Ex nA ic IIC T4 Gc X

SIL 2 according to EN 61508

Ordering data

Type	Order No.	Pcs. / Pkt.
MACX MCR-SL-TC-I ¹⁾	2924333	1
MACX MCR-SL-TC-I-NC ¹⁾	2924346	1

Accessories

IFS-USB-PROG-ADAPTER ¹⁾	2811271	1
------------------------------------	---------	---

Order key and temperature ranges for MACX-MCR-SL-TC-I temperature transducer

Order key for MACX-MCR-SL-TC-I temperature transducer (standard configuration entered as an example)

Order No.	Sensor type	Safety integrity level (SIL)	Cold junction compensation	Measuring range:		Measuring unit	Output range	Filter Oversampling	Filter Moving average value
				Start	End				
2924333	J	ON	1	0	1000	C	OUT02	10	1
MACX MCR-SL-TC-I	see below	ON ≙ active NONE ≙ not active ON only with output range = OUT02	1 ≙ switched on 0 ≙ switched off (e.g., for mV voltage measurement)	see below	see below	C ≙ °C F ≙ °F V ≙ mV	OUT01 ≙ 0...20 mA OUT02 ≙ 4...20 mA	1 ≙ 1 value 3 ≙ 3 values 5 ≙ 5 values 7 ≙ 7 values 10 ≙ 10 values 20 ≙ 20 values	1 ≙ 1 value 2 ≙ 2 values 3 ≙ 3 values 4 ≙ 4 values
							Smallest measuring range span		
V03 ≙ Voltage (mV)				-20	+70	mV	3 mV		
E ≙ acc. to IEC 584-1 (NiCr-CuNi)				-250	1000	°C	50 K		
J ≙ acc. to IEC 584-1 (Fe-CuNi)				-210	1200	°C	50 K		
K ≙ acc. to IEC 584-1 (NiCr-Ni)				-250	1372	°C	50 K		
N ≙ acc. to IEC 584-1 (NiCrSi-NiSi)				-250	1300	°C	50 K		
L ≙ acc. to DIN 43760 (Fe-CuNi)				-200	900	°C	50 K		

Alarm signal
Overrange

Alarm signal
Sensor break/
underrange

Factory calibration certificate = FCC

I035	I215	NONE	Temperature conversion guide for °C to °F:
I000 ≙ 0 mA I035 ≙ 3.5 mA I215 ≙ 21.5 mA I035 only with output range = OUT02 Alarm signals can also be configured individually using software.	I000 ≙ 0 mA I035 ≙ 3.5 mA I215 ≙ 21.5 mA	NONE ≙ without FCC YES ≙ with FCC (a fee is charged) YESPLUS ≙ FCC with 5 measuring points (a fee is charged)	$T [°F] = \frac{9}{5} T [°C] + 32$

Temperature Temperature transducer

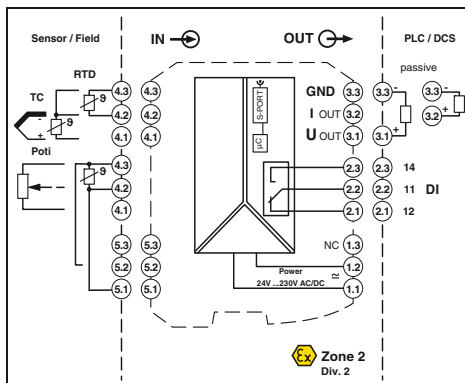
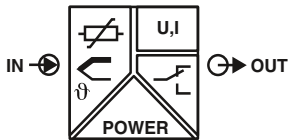

Universal, with switching output,
wide-range power supply

Functional safety
Ex:
Housing width 17.5 mm

Universal temperature transducer with freely configurable properties

- Input for resistance thermometers, thermocouples, resistance-type sensors, potentiometers, and mV sources
- Measure differential temperatures
- Freely programmable input and output
- Option of inverse output signal ranges
- Relay switching output
- Configuration via software (FDT-DTM) or IFS-OP-UNIT operating and display unit
- Programming during operation and also voltage-free using IFS-USB-PROG-ADAPTER programming adapter
- Plug-in capable screw or spring-cage connection method
- Cold junction compensation with separate connector
- Wide-range power supply: 19.2 ... 253 V AC/DC
- Status indicator for supply voltage, cable, sensor, and module errors
- Up to SIL 2 according to EN 61508
- Installation in zone 2 permitted

Input data	Resistance thermometers Thermocouple sensors
Resistor Potentiometer Voltage	
Output data	Output signal
Maximum output signal Load R_B Behavior in the event of a sensor error	
Switching output	Contact type Contact material Maximum switching voltage Maximum switching current
General data	Supply voltage range Power consumption Temperature coefficient Transmission error, total Electrical isolation
	Input/output/power supply
	Input/output Input/power supply Input/switching output
Ambient temperature range Humidity Housing material Inflammability class according to UL 94 Dimensions W / H / D Screw connection solid / stranded / AWG Spring-cage connection (solid/stranded/AWG)	
Conformance / approvals	Conformance ATEX IECEX Functional safety (SIL)

Technical data

Pt, Ni, Cu sensors: 2, 3, 4-conductor B, E, J, K, N, R, S, T, L, U, CA, DA, A1G, A2G, A3G, MG, LG	
0 Ω ... 50 k Ω 0 Ω ... 50 k Ω -1000 mV ... 1000 mV	
U output 4 mA ... 20 mA (in the case of SIL; further free configuration without SIL)	I output
± 11 V ≥ 10 k Ω	22 mA $\leq 600 \Omega$ (20 mA)
According to NE 43 or freely configurable	
Relay output 1 PDT AgSnO ₂ , hard gold-plated 30 V AC (30 V DC) 0.5 A (30 V AC) / 1 A (30 V DC)	
24 V ... 230 V AC/DC (-20%/+10%, 50/60 Hz) < 1.5 W 0.01%/K < 0.1% (e.g., for Pt 100, 300 K span, 4 ... 20 mA)	
2.5 kV 1 (50 Hz, 1 min., test voltage) 300 V _{rms} (Rated insulation voltage, surge voltage category II; pollution degree 2, safe isolation as per EN 61010, EN 50178)	
375 V (Peak value in accordance with EN 60079-11) 375 V (Peak value in accordance with EN 60079-11) 375 V (Peak value in accordance with EN 60079-11) -20°C ... 65°C Typ. 5% ... 95% (no condensation) PA 66-FR V0 17.5 / 99 / 114.5 mm 0.2 ... 2.5 mm ² / 0.2 ... 2.5 mm ² / 24 - 14 0.2 ... 1.5 mm ² / 0.2 ... 1.5 mm ² / 24 - 16	
CE-compliant II 3 G Ex nA nC ic IIC T4 Gc X Ex nA nC ic IIC T4 Gc X SIL 2, PL d	

Notes:
To order a product with an order configuration, enter the required configuration by referring to the adjacent order key.
The configuration software can be downloaded from the Internet (www.phoenixcontact.net/products).
Information on the IFS-OP-UNIT operating and display unit and the associated IFS-OP-CRADLE DIN rail cradle can be found on page 118
For information on the programming adapter, refer to page 119
1) EMC: Class A product, see page 571

Description	
Temperature transducer	
Standard configuration	Screw connection
Standard configuration	Spring-cage conn.
Order configuration	Screw connection
Order configuration	Spring-cage conn.

Programming adapter for configuring modules with S-PORT interface
--

Ordering data

Type	Order No.	Pcs. / Pkt.
MACX MCR-T-UI-UP ¹⁾	2811394	1
MACX MCR-T-UI-UP-SP ¹⁾	2811860	1
MACX MCR-T-UI-UP-C ¹⁾	2811873	1
MACX MCR-T-UI-UP-SP-C ¹⁾	2811970	1

Accessories

IFS-USB-PROG-ADAPTER ¹⁾	2811271	1
------------------------------------	---------	---

Temperature Temperature transducer

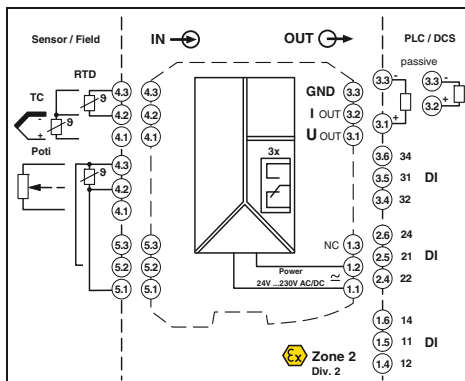
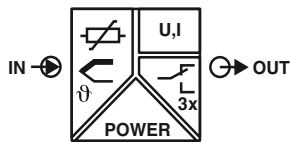

**Universal, with three limit value relays,
wide-range power supply**

Functional safety
Ex:
Housing width 35 mm

Universal temperature transducer with freely configurable properties

- Input for resistance thermometers, thermocouples, resistance-type sensors, potentiometers, and mV sources
- Measure differential temperatures
- Freely programmable input and output
- Option of inverse output signal ranges
- Three limit value relays, can be used in combination as a safe limit value relay
- Configuration via software (FDT-DTM) or IFS-OP-UNIT operating and display unit
- Programming during operation and also voltage-free using IFS-USB-PROG-ADAPTER programming adapter
- Plug-in capable screw or spring-cage connection method
- Cold junction compensation with separate connector
- Wide-range power supply: 19.2 ... 253 V AC/DC
- Status indicator for supply voltage, cable, sensor, and module errors
- Up to SIL 2 according to EN 61508
- Installation in zone 2 permitted

Input data	
Resistance thermometers	
Thermocouple sensors	
Resistor	
Potentiometer	
Voltage	
Output data	
Output signal	
Maximum output signal	
Load R_B	
Behavior in the event of a sensor error	
Switching output	
Contact type	
Contact material	
Maximum switching voltage	
Maximum switching current	
General data	
Supply voltage range	
Power consumption	
Temperature coefficient	
Transmission error, total	
Electrical isolation	
	Input/output/power supply
	Input/output
	Input/power supply
	Input/switching output
Ambient temperature range	
Humidity	
Housing material	
Inflammability class according to UL 94	
Dimensions W / H / D	
Screw connection solid / stranded / AWG	
Spring-cage connection (solid/stranded/AWG)	
Conformance / approvals	
Conformance	
ATEX	
IECEX	
Functional safety (SIL)	

Technical data

Pt, Ni, Cu sensors: 2, 3, 4-conductor	
B, E, J, K, N, R, S, T, L, U, CA, DA, A1G, A2G, A3G, MG, LG	
0 Ω ... 50 k Ω	
0 Ω ... 50 k Ω	
-1000 mV ... 1000 mV	
U output	
4 mA ... 20 mA (in the case of SIL; further free configuration without SIL)	I output
± 11 V	22 mA
≥ 10 k Ω	$\leq 600 \Omega$ (20 mA)
According to NE 43 or freely configurable	
Relay output	
3 PDTs	
AgSnO ₂ , hard gold-plated	
250 V AC (250 V DC)	
2 A (250 V AC) / 2 A (28 V DC)	
24 V ... 230 V AC/DC (-20%/+10%, 50/60 Hz)	
< 2.4 W	
0.01%/K	
< 0.1% (e.g., for Pt 100, 300 K span, 4 ... 20 mA)	
2.5 kV (50 Hz, 1 min., test voltage)	
300 V _{rms} (Rated insulation voltage, surge voltage category II; pollution degree 2, safe isolation as per EN 61010, EN 50178)	
375 V (Peak value in accordance with EN 60079-11)	Input/output
375 V (Peak value in accordance with EN 60079-11)	Input/power supply
375 V (Peak value in accordance with EN 60079-11)	Input/switching output
-20°C ... 65°C	
Typ. 5% ... 95% (no condensation)	
PA 66-FR	
V0	
35 / 99 / 114.5 mm	
0.2 ... 2.5 mm ² / 0.2 ... 2.5 mm ² / 24 - 14	
0.2 ... 1.5 mm ² / 0.2 ... 1.5 mm ² / 24 - 16	
CE-compliant	
II 3 G Ex nA nC ic IIC T4 Gc X	
Ex nA nC ic IIC T4 Gc X	
SIL 2, PL d	

Notes:
To order a product with an order configuration, enter the required configuration by referring to the adjacent order key.
The configuration software can be downloaded from the Internet (www.phoenixcontact.net/products).
Information on the IFS-OP-UNIT operating and display unit and the associated IFS-OP-CRADLE DIN rail cradle can be found on page 118
For information on the programming adapter, refer to page 119
1) EMC: Class A product, see page 571

Description	
Temperature transducer	
Standard configuration	Screw connection
Standard configuration	Spring-cage conn.
Order configuration	Screw connection
Order configuration	Spring-cage conn.

Programming adapter for configuring modules with S-PORT interface

Ordering data

Type	Order No.	Pcs. / Pkt.
MACX MCR-T-UIREL-UP ¹⁾	2811378	1
MACX MCR-T-UIREL-UP-SP ¹⁾	2811828	1
MACX MCR-T-UIREL-UP-C ¹⁾	2811514	1
MACX MCR-T-UIREL-UP-SP-C ¹⁾	2811831	1

Accessories

IFS-USB-PROG-ADAPTER ¹⁾	2811271	1
------------------------------------	---------	---

Isolating amplifiers with SIL functional safety - MACX Analog

Order key for MACX-MCR-T-UIREL-UP(-SP)-C temperature transducer (standard configuration entered as an example)

Order No.	Safety integrity level (SIL)	Sensor type	Connection technology	Cold junction compensation	Measuring range:		Measuring unit	Output range	Factory calibration certificate = FCC
					Start	End			
2811514	ON	PT100	4	0	-50	150	C	OUT02	NONE
2811514 ≙ MACX MCR-T-UIREL-UP-C	ON ≙ active NONE ≙ not active	see below	2 ≙ 2-conductor 3 ≙ 3-conductor 4 ≙ 4-conductor	0 ≙ off, e.g., with RTD, R, potentiometer, mV 1 ≙ on, e.g., with TC	see below	see below	C ≙ °C F ≙ °F O ≙ Ω P ≙ % V ≙ mV	OUT15 ≙ 0...5 mA OUT16 ≙ 0...10 mA OUT01 ≙ 0...20 mA OUT15 ≙ 0...5 mA OUT25 ≙ 1...5 mA OUT26 ≙ 2...10 mA OUT02 ≙ 4...20 mA OUT05 ≙ 0...5 V OUT03 ≙ 0...10 V OUT06 ≙ 1...5 V OUT04 ≙ 2...10 V OUT13 ≙ -5...+5 V OUT14 ≙ -10...+10 V Others can be freely configured in the software	NONE ≙ without FCC YES ≙ with FCC (a fee is charged) YESPLUS ≙ FCC with 5 measuring points (a fee is charged)
2811831 ≙ MACX MCR-T-UIREL-UP-SP-C	ON only with output range = OUT02								
Resistance thermometers (RTD) Others can be selected or freely configured in the software.		PT100 ≙ Pt 100 acc. to IEC 751			-200	850	°C	20 K	Other setting options can be configured with the IFS-CONF software: - Freely configurable user characteristic curve with 30 interpolation points - Output behavior in the event of a short circuit, sensor break or overrange/underrange can be freely configured or set according to NE43 (standard configuration: NE43 upscale) - Filter setting (standard configuration: 1) - Restart after failsafe (standard configuration: ON) - Switching behavior: switching output ? (limit values, times, etc.) (standard configuration: OFF)
	PT200 ≙ Pt 200 acc. to IEC 751			-200	850	°C	20 K		
	PT500 ≙ Pt 500 acc. to IEC 751			-200	850	°C	20 K		
	PT1000 ≙ Pt 1000 acc. to IEC 751			-200	850	°C	20 K		
	PT100S ≙ Pt 100 acc. to Sama RC21-4-1966			-200	850	°C	20 K		
	PT1000S ≙ Pt 1000 acc. to Sama RC21-4-1966			-200	850	°C	20 K		
	PT100G ≙ Pt 100 acc. to GOST 6651-2009 (α = 0.00385)			-200	850	°C	20 K		
	PT1000G ≙ Pt 1000 acc. to GOST 6651-2009 (α = 0.00385)			-200	850	°C	20 K		
	PT100J ≙ Pt 100 acc. to JIS C1604/1997			-200	850	°C	20 K		
	PT1000J ≙ Pt 1000 acc. to JIS C1604/1997			-200	850	°C	20 K		
	NI100 ≙ Ni 100 acc. to DIN 43760/DIN IEC 60751			-60	250	°C	20 K		
	NI1000 ≙ Ni 1000 acc. to DIN 43760/DIN IEC 60751			-60	250	°C	20 K		
	NI100S ≙ Ni 100 acc. to Sama RC21-4-1966			-60	180	°C	20 K		
	NI1000S ≙ Ni 1000 acc. to Sama RC21-4-1966			-60	180	°C	20 K		
	NI1000L ≙ Ni 1000 (Landis & Gyr)			-50	160	°C	20 K		
	CU10 ≙ Cu 10 acc. to Sama RC21-4-1966			-70	500	°C	100 K		
	CU50 ≙ Cu 50 acc. to GOST 6651-2009 (α = 1.428)			-50	200	°C	100 K		
	CU100 ≙ Cu 100 acc. to GOST 6651-2009 (α = 1.428)			-50	200	°C	100 K		
	CU53 ≙ Cu 53 acc. to GOST 6651-2009 (α = 1.426)			-50	180	°C	100 K		
	KTY81 ≙ KTY81-110 (Philips)			-55	150	°C	20 K		
	KTY84 ≙ KTY84-130 (Philips)			-40	300	°C	20 K		
Thermocouples (TC) Others can be selected in the software.		B ≙ acc. to IEC 584-1 (Pt30Rh-Pt6Rh)			500	1820	°C	50 K	
	E ≙ acc. to IEC 584-1 (NiCr-CuNi)			-230	1000	°C	50 K		
	J ≙ acc. to IEC 584-1 (Fe-CuNi)			-210	1200	°C	50 K		
	K ≙ acc. to IEC 584-1 (NiCr-Ni)			-250	1372	°C	50 K		
	N ≙ acc. to IEC 584-1 (NiCrSi-NiSi)			-250	1300	°C	50 K		
	R ≙ acc. to IEC 584-1 (Pt13Rh-Pt)			-50	1768	°C	50 K		
	S ≙ acc. to IEC 584-1 (Pt10Rh-Pt)			-50	1768	°C	50 K		
	T ≙ acc. to IEC 584-1 (Cu-CuNi)			-200	400	°C	50 K		
	L ≙ acc. to DIN 43760 (Fe-CuNi)			-200	900	°C	50 K		
	U ≙ acc. to DIN 43760 (Cu-CuNi)			-200	600	°C	50 K		
	CA ≙ C ASTM JE988 (2002)			0	2315	°C	50 K		
	DA ≙ D ASTM JE988 (2002)			0	2315	°C	50 K		
	A1G ≙ A-1 GOST 8.585-2001			0	2500	°C	50 K		
	A2G ≙ A-2 GOST 8.585-2001			0	1800	°C	50 K		
	A3G ≙ A-3 GOST 8.585-2001			0	1800	°C	50 K		
	MG ≙ M GOST 8.585-2001			-200	100	°C	50 K		
	LG ≙ L GOST 8.585-2001			-200	800	°C	50 K		
Remote resistance-type sensors (R) (2, 3, 4-conductor) Others can be selected in the software.		RES03 ≙ 0...150 Ω resistor			0	150	Ω	10% of the selected measuring range	
	RES05 ≙ 0...600 Ω resistor			0	600	Ω			
	RES06 ≙ 0...1200 Ω resistor			0	1200	Ω			
	RES09 ≙ 0...6250 Ω resistor			0	6250	Ω			
	RES10 ≙ 0...12500 Ω resistor			0	12500	Ω			
	RES12 ≙ 0...50000 Ω resistor			0	50000	Ω			
Potentiometers (3-conductor) Others can be selected in the software.		POT03 ≙ 0...150 Ω potentiometer			0	100	%	10% of the selected measuring range	
	POT05 ≙ 0...600 Ω potentiometer			0	100	%			
	POT06 ≙ 0...1200 Ω potentiometer			0	100	%			
	POT09 ≙ 0...6250 Ω potentiometer			0	100	%			
	POT10 ≙ 0...12500 Ω potentiometer			0	100	%			
	POT12 ≙ 0...50000 Ω potentiometer			0	100	%			
Voltage signals (mV) Others can be selected in the software.		V04 ≙ Voltage (mV)			-1000	+1000	mV	10% of nominal span	

Temperature conversion guide for °C to °F:

$$T [°F] = \frac{9}{5} T [°C] + 32$$

Accessories

Operating and display unit

- Local display of actual values
- Copy function
- Easy guided operation
- Easy configuration without PC software
- Operating and display unit can be snapped directly onto compatible devices with a housing width of 35 mm
- DIN rail mounting possible for thinner devices in conjunction with cradle unit
- Backlighting
- Installation in zone 2 permissible



Can be snapped directly onto compatible 35 mm devices

Notes:
1) EMC: Class A product, see page 571

General data	
Ambient temperature range	
Humidity	
Housing material	
Dimensions W / H / D	
Connection method	PC side Measuring transducer side

Technical data

Ambient temperature range	-20°C ... 65°C (-4°F ... 149°F)
Humidity	90% (at 25°C, no condensation)
PA	6.6
Dimensions W / H / D	35 / 99 / 20 mm
Connection method	S port (socket) S port (plug)

Conformance / approvals	
Conformance	CE-compliant
ATEX	Ex II 3G Ex nA ic IIC T4 Gc X
IECEX	Ex nA ic IIC T4 Gc X

Ordering data

Description	
Operating and display unit	

Type	Order No.	Pcs. / Pkt.
IFS-OP-UNIT ¹⁾	2811899	1

Accessories

Cradle unit

- For snapping onto the DIN rail
- For control cabinet mounting of the operating and display unit

Notes:
1) EMC: Class A product, see page 571



Cradle for operating and display unit

General data	
Ambient temperature range	
Humidity	
Housing material	
Dimensions W / H / D	
Connection method	IFS-OP-UNIT operator interface Measuring transducer side

Technical data

Ambient temperature range	-20°C ... 65°C (-4°F ... 149°F)
Humidity	90% (at 25°C, no condensation)
PA	6.6
Dimensions W / H / D	35.2 / 29 / 99 mm
Connection method	S port (socket) S port (plug)

Conformance / approvals	
Conformance	CE-compliant
ATEX	Ex II 3G Ex nA ic IIC T4 Gc X
IECEX	Ex nA ic IIC T4 Gc X

Ordering data

Description	
Cradle unit , for snapping the operating and display unit onto the DIN rail	

Type	Order No.	Pcs. / Pkt.
IFS-OP-CRADLE ¹⁾	2811886	1

Accessories

Programming adapter

The IFS-USB-PROG-ADAPTER programming adapter is used for configuring Phoenix Contact INTERFACE modules with S-PORT interface.

The adapter is used with FDT/DTM software or ANALOG-CONF software. For programming MACX Analog and MINI Analog.



Notes:
1) EMC: Class A product, see page 571

Applied for:
cUL / UL

Ordering data			
Description	Type	Order No.	Pcs. / Pkt.
Programming adapter for configuring modules with S-PORT interface	IFS-USB-PROG-ADAPTER ¹⁾	2811271	1

Digital IN
NAMUR isolation amplifiers

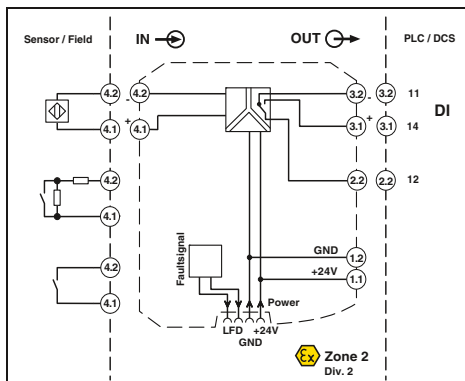
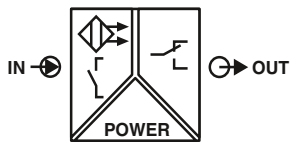

Ex n



Signal output: PDT relay

NAMUR isolation amplifier for operating proximity sensors and mechanical contacts

- Input for NAMUR proximity sensors (EN 60947-5-6), floating contacts or contacts with resistance circuit
- Relay signal output (PDT)
- Reversible direction of action (operating current or closed-circuit current behavior)
- Line fault detection (LFD), can be activated/deactivated, error message signaled by red flashing LED with de-excitation of output relay
- Power supply and error indication possible via the DIN rail connector
- LED displays for indicating supply voltage, circuit state, and malfunctions to NAMUR NE 44
- 3-way electrical isolation
- Up to SIL 2 according to EN 61508
- Installation in zone 2 permitted

Notes:
Information about the supply and error evaluation module as well as about the DIN rail connectors and marking material can be found from page 126
Information about resistance circuits is given on page 183
Information on "Plug and play" connection using system cabling can be found from page 128
1) EMC: Class A product, see page 571

Input data	Input signal
No-load voltage	Switching points
Switching hysteresis	Line error detection
Switching output	Contact type
Contact material	Maximum switching voltage
Maximum switching capacity	Recommended minimum load
Mechanical service life	Switching behavior
Maximum switching frequency	General data
Supply voltage range	Current consumption
Power dissipation	Electrical isolation
Electrical isolation	Input/output/supply, T-Connector
Ambient temperature range	Humidity
Housing material	Inflammability class according to UL 94
Dimensions W / H / D	Screw connection solid / stranded / AWG
Screw connection solid / stranded / AWG	Spring-cage connection (solid/stranded/AWG)
Conformance / approvals	Conformance
ATEX	Functional safety (SIL)

Functional safety
Ex: Ex
Housing width 12.5 mm

Technical data	
NAMUR proximity sensors (EN 60947-5-6)	
Floating switch contacts	
Switch contacts with resistance circuit	
8 V DC $\pm 10\%$	
> 2.1 mA (conductive) / < 1.2 mA (blocking)	
< 0.2 mA	
Break 0.05 mA $< I_N < 0.35$ mA	
Short-circuit $100 \Omega < R_{\text{sensor}} < 360 \Omega$	
Relay output	
1 PDT	
AgSnO ₂ , hard gold-plated	
250 V AC (2 A) / 120 V DC (0.2 A) / 30 V DC (2 A)	
500 VA	
5 V / 10 mA	
10 ⁷ cycles	
Can be inverted via slide switch	
20 Hz (without load)	
19.2 V DC ... 30 V DC	
21 mA (24 V DC)	
< 650 mW	
300 V _{rms} (Rated insulation voltage, surge voltage category II; pollution degree 2, safe isolation as per EN 61010, EN 50178)	
2.5 kV (50 Hz, 1 min., test voltage)	
-20°C ... 60°C (Any mounting position)	
10% ... 95% (no condensation)	
PA 66-FR	
V0	
12.5 / 99 / 114.5 mm	
0.2 ... 2.5 mm ² / 0.2 ... 2.5 mm ² / 24 - 14	
0.2 ... 1.5 mm ² / 0.2 ... 1.5 mm ² / 24 - 16	
CE-compliant, additionally EN 61326	
Ex II 3 G Ex nA nC IIC T4 Gc X	
SIL 2 according to EN 61508	

Ordering data		
Type	Order No.	Pcs. / Pkt.
MACX MCR-SL-NAM-R ¹⁾	2865997	1
MACX MCR-SL-NAM-R-SP ¹⁾	2924252	1

Description
NAMUR isolation amplifier
Screw connection
Spring-cage conn.

Digital IN
NAMUR isolation amplifiers

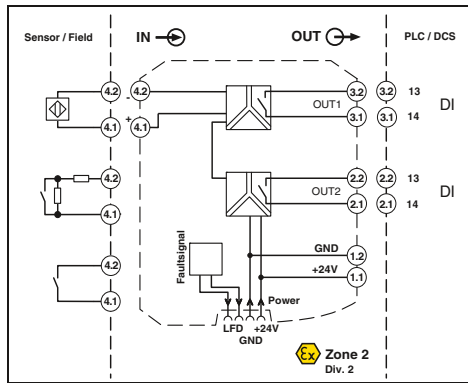
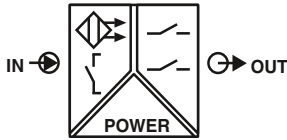

2 signal outputs: N/O contact relay

Functional safety

Ex: Ex n

Housing width 12.5 mm

NAMUR isolation amplifier for operating proximity sensors and mechanical contacts

- Input for NAMUR proximity sensors (EN 60947-5-6), floating contacts or contacts with resistance circuit
- Two relay signal outputs (N/O contact); output 2 can be used as an error message output
- Reversible direction of action (operating current or closed-circuit current behavior)
- Line fault detection (LFD), can be activated/deactivated, error message signaled by red flashing LED with de-excitation of output relay
- Power supply and error indication possible via the DIN rail connector
- LED displays for indicating supply voltage, circuit state, and malfunctions to NAMUR NE 44
- 4-way electrical isolation
- Up to SIL 2 according to EN 61508
- Installation in zone 2 permitted

Input data

Input signal

- No-load voltage
- Switching points
- Switching hysteresis
- Line error detection

Switching output

- Contact type
- Contact material
- Maximum switching voltage
- Maximum switching capacity
- Recommended minimum load
- Mechanical service life
- Switching behavior
- Maximum switching frequency

General data

- Supply voltage range
- Current consumption
- Power dissipation
- Electrical isolation

Input/supply, T connector

Output 1/output 2/input, power supply, T connector

- Ambient temperature range
- Humidity
- Housing material
- Inflammability class according to UL 94
- Dimensions W / H / D
- Screw connection solid / stranded / AWG
- Spring-cage connection (solid/stranded/AWG)

Conformance / approvals

- Conformance
- ATEX
- Functional safety (SIL)

Technical data

NAMUR proximity sensors (EN 60947-5-6)
 Floating switch contacts
 Switch contacts with resistance circuit
 8 V DC $\pm 10\%$
 > 2.1 mA (conductive) / < 1.2 mA (blocking)
 < 0.2 mA
 Break 0.05 mA $< I_N < 0.35$ mA
 Short-circuit $100 \Omega < R_{\text{Sensor}} < 360 \Omega$
 Relay output
 2 N/O contacts
 AgSnO₂, hard gold-plated
 250 V AC (2 A) / 120 V DC (0.2 A) / 30 V DC (2 A)
 500 VA
 5 V / 10 mA
 10⁷ cycles
 Can be inverted via slide switch
 20 Hz (without load)

19.2 V DC ... 30 V DC
 30 mA (24 V DC)
 < 950 mW

2.5 kV (50 Hz, 1 min., test voltage)
 300 V_{rms} (Rated insulation voltage, surge voltage category II; pollution degree 2, safe isolation as per EN 61010, EN 50178)

2.5 kV (50 Hz, 1 min., test voltage)
 300 V_{rms} (Rated insulation voltage, surge voltage category III; pollution degree 2, safe isolation as per EN 61010, EN 50178)

-20°C ... 60°C (Any mounting position)
 10% ... 95% (no condensation)

PA 66-FR
 V0
 12.5 / 99 / 114.5 mm
 0.2 ... 2.5 mm² / 0.2 ... 2.5 mm² / 24 - 14
 0.2 ... 1.5 mm² / 0.2 ... 1.5 mm² / 24 - 16

CE-compliant, additionally EN 61326
 Ex II 3 G Ex nA nC IIC T4 Gc X
 SIL 2 according to EN 61508

Notes:

Information about the supply and error evaluation module as well as about the DIN rail connectors and marking material can be found from page 126
Information about resistance circuits is given on page 183
Information on "Plug and play" connection using system cabling can be found from page 128
1) EMC: Class A product, see page 571

Ordering data

Description	Type	Order No.	Pcs. / Pkt.	
NAMUR isolation amplifier	Screw connection	MACX MCR-SL-NAM-2RO ¹⁾	2865010	1
	Spring-cage conn.	MACX MCR-SL-NAM-2RO-SP ¹⁾	2924265	1

Digital IN
NAMUR isolation amplifiers

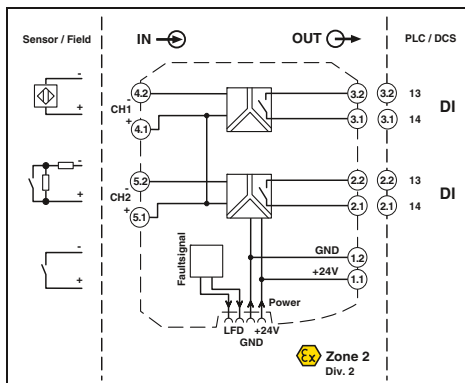
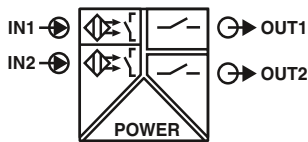

Ex n



SIL IEC 61508



2-channel, signal output: N/O contact relay

Functional safety

Ex: Ex

Housing width 12.5 mm

NAMUR isolating amplifier for intrinsically safe operation of proximity sensors and mechanical contacts installed in Ex areas.

- 2-channel
- Input for NAMUR proximity sensors (EN 60947-5-6), floating contacts or contacts with resistance circuit
- Relay signal output (N/O contact)
- Reversible direction of action (operating current or closed-circuit current behavior)
- Line fault detection (LFD), can be activated/deactivated, error message signaled by red flashing LED with de-excitation of output relay
- Power supply and error indication possible via the DIN rail connector
- LED displays for indicating supply voltage, circuit state, and malfunctions to NAMUR NE 44
- 3-way electrical isolation
- Up to SIL 2 according to EN 61508
- Installation in zone 2 permitted

Notes:
Information about the supply and error evaluation module as well as about the DIN rail connectors and marking material can be found from page 126
Information about resistance circuits is given on page 183
Information on "Plug and play" connection using system cabling can be found from page 128
1) EMC: Class A product, see page 571

Input data
Input signal
No-load voltage
Switching points
Switching hysteresis
Line error detection
Switching output
Contact type
Contact material
Maximum switching voltage
Maximum switching capacity
Recommended minimum load
Mechanical service life
Switching behavior
Maximum switching frequency
General data
Supply voltage range
Current consumption
Power dissipation
Electrical isolation
Input/supply, T connector
Output 1/output 2/input, power supply, T connector
Ambient temperature range
Humidity
Housing material
Inflammability class according to UL 94
Dimensions W / H / D
Screw connection solid / stranded / AWG
Spring-cage connection (solid/stranded/AWG)
Conformance / approvals
Conformance
ATEX
Functional safety (SIL)

Technical data
NAMUR proximity sensors (EN 60947-5-6)
Floating switch contacts
Switch contacts with resistance circuit
8 V DC ±10%
> 2.1 mA (conductive) / < 1.2 mA (blocking)
< 0.2 mA
Break 0.05 mA < I _N < 0.35 mA
Short-circuit 100 Ω < R _{sensor} < 360 Ω
Relay output
2 N/O contacts
AgSnO ₂ , hard gold-plated
250 V AC (2 A) / 120 V DC (0.2 A) / 30 V DC (2 A)
500 VA
5 V / 10 mA
10 ⁷ cycles
Can be inverted via slide switch
20 Hz (without load)
19.2 V DC ... 30 V DC
35 mA (24 V DC)
< 1 W
2.5 kV (50 Hz, 1 min., test voltage)
300 V _{rms} (Rated insulation voltage, surge voltage category II; pollution degree 2, safe isolation as per EN 61010, EN 50178)
2.5 kV (50 Hz, 1 min., test voltage)
300 V _{rms} (Rated insulation voltage, surge voltage category III; pollution degree 2, safe isolation as per EN 61010, EN 50178)
-20°C ... 60°C (Any mounting position)
5% ... 95% (no condensation)
PA 66-FR
V0
12.5 / 99 / 114.5 mm
0.2 ... 2.5 mm ² / 0.2 ... 2.5 mm ² / 24 - 14
0.2 ... 1.5 mm ² / 0.2 ... 1.5 mm ² / 24 - 16
CE-compliant, additionally EN 61326
Ex II 3 G Ex nA nC IIC T4 Gc X
SIL 2 according to EN 61508

Ordering data		
Type	Order No.	Pcs. / Pkt.
MACX MCR-SL-2NAM-RO ¹	2865049	1
MACX MCR-SL-2NAM-RO-SP ¹	2924294	1

Digital IN
NAMUR isolation amplifiers

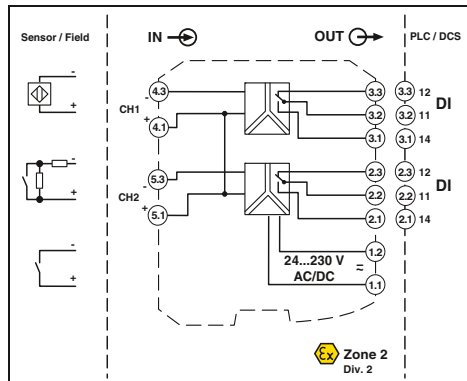
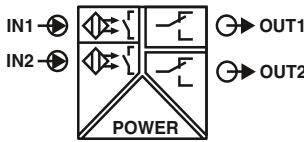

2-channel, signal output: PDT relay, wide-range power supply

Functional safety
Ex:
Housing width 17.5 mm

NAMUR isolation amplifier for operating proximity sensors and mechanical contacts

- 2-channel
- Input for NAMUR proximity sensors (EN 60947-5-6), floating contacts or contacts with resistance circuit
- Relay signal output (PDT)
- Reversible direction of action (operating current or closed-circuit current behavior)
- Line fault detection (LFD), can be activated/deactivated, error message signaled by red flashing LED with de-excitation of output relay
- Wide-range power supply: 19.2 ... 253 V AC/DC
- LED displays for indicating supply voltage, circuit state, and malfunctions to NAMUR NE 44
- 3-way electrical isolation
- Up to SIL 2 according to EN 61508
- Installation in zone 2 permitted

Input data	Input signal
No-load voltage	Switching points
Switching hysteresis	Line error detection
Switching output	Contact type
Contact material	Maximum switching voltage
Maximum switching capacity	Recommended minimum load
Mechanical service life	Switching behavior
Maximum switching frequency	General data
Supply voltage range	Current consumption
Power dissipation	Electrical isolation
Ambient temperature range	Humidity
Housing material	Inflammability class according to UL 94
Dimensions W / H / D	Screw connection solid / stranded / AWG
Spring-cage connection (solid/stranded/AWG)	Conformance / approvals
Conformance	ATEX
Functional safety (SIL)	

Technical data

NAMUR proximity sensors (EN 60947-5-6)	open circuit switch contacts
Switch contacts with resistance circuit	8 V DC ±10%
> 2.1 mA (conductive) / < 1.2 mA (blocking)	Approx. 0.2 mA
Break 0.05 mA < I _N < 0.35 mA	Short-circuit 100 Ω < R _{Sensor} < 360 Ω
Relay output	2 PDT
AgSnO ₂ , hard gold-plated	250 V AC (2 A, 60 Hz) / 120 V DC (0.2 A) / 30 V DC (2 A)
500 VA	5 V / 10 mA
10 ⁷ cycles	can be inverted using DIP switch
20 Hz (Load-dependent)	24 V ... 230 V AC/DC (-20% ... +10%, 50 ... 60 Hz)
< 80 mA ; < 42 mA (24 V DC)	max. 1.3 W
2.5 kV (50 Hz, 1 min., test voltage)	300 V _{rms} (Rated insulation voltage, surge voltage category II; pollution degree 2, safe isolation as per EN 61010, EN 50178)
2.5 kV (50 Hz, 1 min., test voltage)	300 V _{rms} (Rated insulation voltage, surge voltage category III; pollution degree 2, safe isolation as per EN 61010, EN 50178)
-20°C ... 60°C	10% ... 95% (no condensation)
PA 66-FR	V0
17.5 / 99 / 114.5 mm	0.2 ... 2.5 mm ² / 0.2 ... 2.5 mm ² / 24 - 14
0.2 ... 1.5 mm ² / 0.2 ... 1.5 mm ² / 24 - 16	CE-compliant, additionally EN 61326
II 3 G Ex nA nC IIC T4 Gc X	SIL 2 according to EN 61508

Notes:
Information on resistance circuits and marking material can be found on page 183
1) EMC: Class A product, see page 571

Ordering data			
Description	Type	Order No.	Pcs. / Pkt.
NAMUR isolation amplifier			
Screw connection	MACX MCR-SL-2NAM-R-UP ¹⁾	2865052	1
Spring-cage conn.	MACX MCR-SL-2NAM-R-UP-SP ¹⁾	2924304	1

Digital IN
NAMUR isolation amplifiers

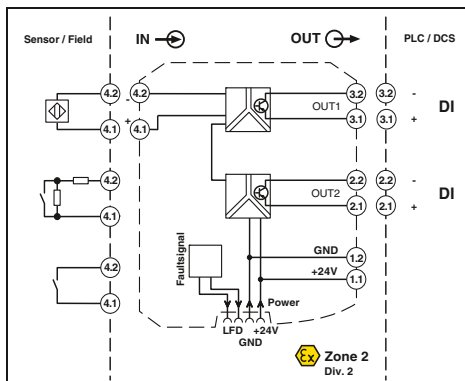
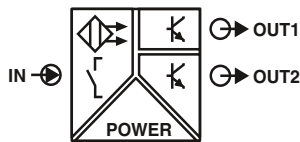

2 signal outputs: transistor (passive)

Functional safety
Ex: Ex n
Housing width 12.5 mm

NAMUR isolation amplifier for operating proximity sensors and mechanical contacts

- Input for NAMUR proximity sensors (EN 60947-5-6), floating contacts or contacts with resistance circuit
- 2 signal outputs: transistor (passive); up to 5 kHz
- Signal output 2 can also be used as a fault signaling output
- Reversible direction of action (operating current or closed-circuit current behavior)
- Line fault detection (LFD), can be activated/deactivated, error message signaled by red flashing LED with inhibiting of transistor output
- Power supply and error indication possible via the DIN rail connector
- LED displays for indicating supply voltage, circuit state, and malfunctions to NAMUR NE 44
- 4-way electrical isolation
- Up to SIL 2 according to EN 61508
- Installation in zone 2 permitted

Notes:
Information about the supply and error evaluation module as well as about the DIN rail connectors and marking material can be found from page 126
Information about resistance circuits is given on page 183
Information on "Plug and play" connection using system cabling can be found from page 128
1) EMC: Class A product, see page 571

Input data
Input signal
No-load voltage
Switching points
Line error detection
Switching output
Maximum switching voltage
Maximum switching current
Drop (ΔU)
Switching behavior
Maximum switching frequency
General data
Supply voltage range
Current consumption
Power dissipation
Electrical isolation
Input/output/supply, T-Connector
Output 1/output 2
Ambient temperature range
Humidity
Housing material
Inflammability class according to UL 94
Dimensions W / H / D
Screw connection solid / stranded / AWG
Spring-cage connection (solid/stranded/AWG)
Conformance / approvals
Conformance
ATEX
Functional safety (SIL)

Technical data

NAMUR proximity sensors (EN 60947-5-6)
Floating switch contacts
Switch contacts with resistance circuit
8 V DC $\pm 10\%$
> 2.1 mA (conductive) / < 1.2 mA (blocking)
Break 0.05 mA $< I_{M1} < 0.35$ mA
Short-circuit $100 \Omega < R_{Sensor} < 360 \Omega$
2 transistor outputs, passive
30 V DC (per output)
50 mA (short-circuit resistant)
< 1.4 V
can be inverted using DIP switch
5 kHz
19.2 V DC ... 30 V DC
< 28 mA (24 V DC)
800 mW
300 V _{rms} (Rated insulation voltage, surge voltage category II; pollution degree 2, safe isolation as per EN 61010, EN 50178)
2.5 kV (50 Hz, 1 min., test voltage)
1 kV (50 Hz, 1 min., test voltage)
50 V _{rms} (Rated insulation voltage, surge voltage category II; pollution degree 2, safe isolation as per EN 61010, EN 50178)
-20°C ... 60°C (Any mounting position)
10% ... 95% (no condensation)
PA 66-FR
V0
12.5 / 99 / 114.5 mm
0.2 ... 2.5 mm ² / 0.2 ... 2.5 mm ² / 24 - 14
0.2 ... 1.5 mm ² / 0.2 ... 1.5 mm ² / 24 - 16
CE-compliant, additionally EN 61326
Ex II 3 G Ex nA IIC T4 Gc X
SIL 2 according to EN 61508

Ordering data

Description	Type	Order No.	Pcs. / Pkt.	
NAMUR isolation amplifier	Screw connection	MACX MCR-SL-NAM-2T ¹)	2865023	1
	Spring-cage conn.	MACX MCR-SL-NAM-2T-SP ¹)	2924278	1

Digital IN
NAMUR isolation amplifiers

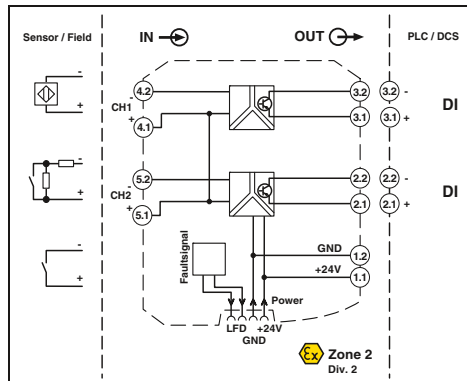
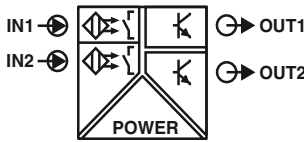

2-channel, signal output transistor (passive)

Functional safety
Ex: Ex n
Housing width 12.5 mm

NAMUR isolation amplifier for operating proximity sensors and mechanical contacts

- 2-channel
- Input for NAMUR proximity sensors (EN 60947-5-6), floating contacts or contacts with resistance circuit
- Signal output transistor (passive); up to 5 kHz
- Reversible direction of action (operating current or closed-circuit current behavior)
- Line fault detection (LFD), can be activated/deactivated, error message signaled by red flashing LED with inhibiting of transistor output
- Power supply and error indication possible via the DIN rail connector
- LED displays for indicating supply voltage, circuit state, and malfunctions to NAMUR NE 44
- 3-way electrical isolation
- Up to SIL 2 according to EN 61508
- Installation in zone 2 permitted

Input data	
Input signal	
No-load voltage	
Switching points	
Line error detection	
Switching output	
Maximum switching voltage	
Maximum switching current	
Drop (ΔU)	
Switching behavior	
Maximum switching frequency	
General data	
Supply voltage range	
Current consumption	
Power dissipation	
Electrical isolation	
	Input/output/supply, T-Connector
	Output 1/output 2
Ambient temperature range	
Humidity	
Housing material	
Inflammability class according to UL 94	
Dimensions W / H / D	
Screw connection solid / stranded / AWG	
Spring-cage connection (solid/stranded/AWG)	
Conformance / approvals	
Conformance	
ATEX	
Functional safety (SIL)	

Technical data

NAMUR proximity sensors (EN 60947-5-6)
Floating switch contacts
Switch contacts with resistance circuit
8 V DC $\pm 10\%$
> 2.1 mA (conductive) / < 1.2 mA (blocking)
Break 0.05 mA $< I_{M} < 0.35$ mA
Short-circuit $100 \Omega < R_{Sensor} < 360 \Omega$
Transistor output, passive
30 V DC (per output)
50 mA (short-circuit resistant)
< 1.4 V
can be inverted using DIP switch
5 kHz
19.2 V DC ... 30 V DC
< 34 mA (24 V DC)
1000 mW
300 V _{rms} (Rated insulation voltage, surge voltage category II; pollution degree 2, safe isolation as per EN 61010, EN 50178)
2.5 kV (50 Hz, 1 min., test voltage)
1 kV (50 Hz, 1 min., test voltage)
50 V _{rms} (Rated insulation voltage, surge voltage category II; pollution degree 2, safe isolation as per EN 61010, EN 50178)
-20°C ... 60°C (Any mounting position)
10% ... 95% (no condensation)
PA 66-FR
V0
12.5 / 99 / 114.5 mm
0.2 ... 2.5 mm ² / 0.2 ... 2.5 mm ² / 24 - 14
0.2 ... 1.5 mm ² / 0.2 ... 1.5 mm ² / 24 - 16
CE-compliant, additionally EN 61326
Ex II 3 G Ex nA IIC T4 Gc X
SIL 2 according to EN 61508

Notes:
Information about the supply and error evaluation module as well as about the DIN rail connectors and marking material can be found from page 126
Information about resistance circuits is given on page 183
Information on "Plug and play" connection using system cabling can be found from page 128
1) EMC: Class A product, see page 571

Ordering data

Description	Type	Order No.	Pcs. / Pkt.
NAMUR isolation amplifier			
Screw connection	MACX MCR-SL-2NAM-T ¹⁾	2865036	1
Spring-cage conn.	MACX MCR-SL-2NAM-T-SP ¹⁾	2924281	1

Accessories

Power and error message module

Power and error message module for feeding the 24 V supply voltage to the DIN rail connectors and signaling line faults and power supply failures.

- One-time or redundant supply, decoupled from diode, protected against polarization
- Supply current up to 3.75 A
- Relay output (PDT) and flashing LED for error messages
- Error message in the event of a power supply failure or fuse fault
- Bus cable fault message for MACX MCR-...(2)NAM... devices connected via DIN rail connectors
- Replaceable fuse
- Installation in zone 2 permissible

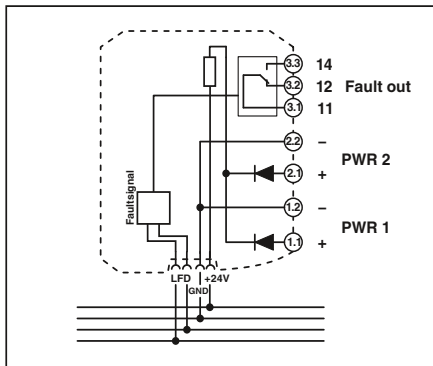

Ex n



Ex: Ex n IIC T4 Gc X // Applied for: cUL / UL
Housing width 17.5 mm

Technical data

Input data	
Input signal	
Redundant supply	
Polarization and surge protection	
Output data	
Maximum output signal	
Output voltage	
Switching output	
Contact type	
Contact material	
Maximum switching voltage	
General data	
Current consumption	
Ambient temperature range	
Humidity	
Fuse	
Status indication	
Housing material	
Inflammability class according to UL 94	
Dimensions W / H / D	
Screw connection solid / stranded / AWG	
Spring-cage connection (solid/stranded/AWG)	
Conformance / approvals	
Conformance	
ATEX	
IECEX	
UL, USA / Canada	

19.2 V DC ... 30 V DC
yes, decoupled from diodes
Yes
3.75 A
(Input voltage - max 0.8 V at 3.75 A)
Relay
1 PDT
Gold (Au)
50 V AC (2 A)
-20°C ... 60°C (Any mounting position)
5% ... 95% (no condensation)
5 A (replaceable), slow-blow 250 V AC
1 x red LED (error)
2 x green LEDs (PWR1 and PWR2)
Polyamide (PA 6.6)
V0
17.5 / 99 / 114.5 mm
0.2 ... 2.5 mm ² / 0.2 ... 2.5 mm ² / 24 - 14
0.2 ... 1.5 mm ² / 0.2 ... 1.5 mm ² / 24 - 16
CE-compliant
Ex II 3 G Ex nA nC IIC T4 Gc X
Ex nA nC IIC T4 Gc X
UL 61010

Ordering data

Description
Supply and error message module , including the relevant DIN rail connector ME 17,5 TBUS 1,5/5-ST-3,81 GN
Screw connection
Spring-cage conn.

Type	Order No.	Pcs. / Pkt.
MACX MCR-PTB	2865625	1
MACX MCR-PTB-SP	2924184	1

Accessories

ME 6,2 TBUS... T-Connector

DIN rail connector (5-pos.) for bridging the supply voltage of 12.5 mm wide MACX analog modules

- Reduces wiring costs
- System can be extended or module replaced even while process is active
- Inter-extendable



		Ordering data		
Description	Type	Order No.	Pcs. / Pkt.	
DIN rail connector (TBUS), for bridging the supply voltage, can be snapped onto 35 mm DIN rails as per EN 60715, with UL approval	ME 6,2 TBUS-2 1,5/5-ST-3,81 GN	2869728	10	

Accessories

Marking material for device marking

- For device marking inside the control cabinet and in the field
- Self-adhesive with high adhesive strengths
- Large temperature range



		Ordering data		
Description	Color	Type	Order No.	Pcs. / Pkt.
UniCard, with self-adhesive plastic labels		UC-EMLP (11X9)	0819291	10
10-part, lettering field size: 11 x 9 mm UniCard, with self-adhesive plastic labels, marked according to customer specifications For ordering details, see Catalog 5 or www.phoenixcontact.net/products	white	UC-EMLP (11X9) CUS	0824547	1

Termination carrier for MACX Analog Ex isolating amplifiers



TC... termination carriers are compact solutions for quickly and smoothly connecting DIN rail devices from the MACX Analog Ex series to input/output cards of automation systems using system cabling.

The termination carriers combine the advantages of modular DIN rail devices with those offered by plug and play rapid cabling solutions to provide a consistent solution for system technology.

Compact

- Saves up to 30% of space due to compact design

Robust and reliable

- Stable, vibration-resistant aluminum carrier device profile
- PCB is completely decoupled from modules
- PCB without active components
- Redundant supply and monitoring in separate DIN rail module

Easy maintenance

- Use of standard DIN rail devices
- Easy access to connection points
- Quick and safe module connection with plug-in and coded cable sets

Flexible

- Horizontal or vertical DIN rail mounting
- Profile section without pitch markings for I/O cards with specific number of channels
- Can be specifically adapted for I/O cards of various automation systems with different system plug types



Select standard DIN rail device



Select module carrier



Select controller-specific front adapter and system cable



Solutions are also available for MINI Analog, MACX Analog Ex, and Safety

Termination carrier for MACX Analog Ex isolating amplifiers

The **TC-D37SUB-ADIO16-EX-P-UNI** universal termination carrier is a compact solution which connects isolating amplifiers from the MACX Analog series to analog or binary input/output cards of automation systems.

The **TC-D37SUB-AIO16-EX-PS-UNI** termination carrier design, when combined with the MACX MCR-S-MUX HART multiplexer, also enables communication between HART-capable field devices and a management system.

- Connection of up to 16 single-channel (Ex i-)isolating amplifiers
- Universal 1:1 signal routing to a 37-pos. D-SUB plug-in connector
- For system cables with D-SUB socket and open ends for universal connection
- Redundant supply and monitoring in separate DIN rail module

Notes:
Contact us: specific termination carrier designs for I/O modules of various automation systems are available, planned or can be implemented according to your specifications.
1) EMC: Class A product, see page 571



General data	
Connection to the control system level	
Number of positions	
Maximum operating voltage	
Maximum permissible current	
Rated insulation voltage	
Surge voltage category	
Pollution degree	
Rated surge voltage	
Air and creepage distances	
Degree of protection	
Ambient temperature range	
Shock	
Vibration (operation)	
Inflammability class according to UL 94	
Dimensions W / H / D	
Power supply via power module	
Input voltage range	
Redundant supply	
Polarization and surge protection	
Fuse	
Status indication	
Switching output	
Contact material	
Maximum switching voltage	

Technical data	
Housing width 244 mm	
D-SUB pin strip	
37	
< 50 V DC (Per signal/channel)	
1 A (Signal/channel)	
50 V	
II	
2	
0.5 kV	
DIN EN 50178 (Basic insulation)	
IP20	
-40°C ... 80°C (Please observe module specifications)	
15g, according to IEC 60068-2-27	
2g, according to IEC 60068-2-6	
V0	
244 / 170 / 160 mm	
Power supply via power module	
19.2 V DC ... 30 V DC	
yes, decoupled from diodes	
Yes	
5 A Slow-blow (can be exchanged)	
1 x red LED (error)	
2 x green LEDs (PWR1 and PWR2)	
1 PDT	
Au	
50 V DC (0.3 A) / 30 V DC (2 A) / 33 V AC (2 A)	

Description	
Universal termination carrier for 16 MACX MCR-EX isolators	
- With connection for MACX MCR-S-MUX HART multiplexer	

Ordering data		
Type	Order No.	Pcs. / Pkt.
TC-D37SUB-ADIO16-EX-P-UNI	2924854	1
TC-D37SUB-AIO16-EX-PS-UNI¹⁾	2902932	1

Supply and error message module	
HART multiplexer, 32-channel	

Accessories		
MACX MCR-PTB	2865625	1
MACX MCR-PTB-SP	2924184	1
MACX MCR-S-MUX	2865599	1

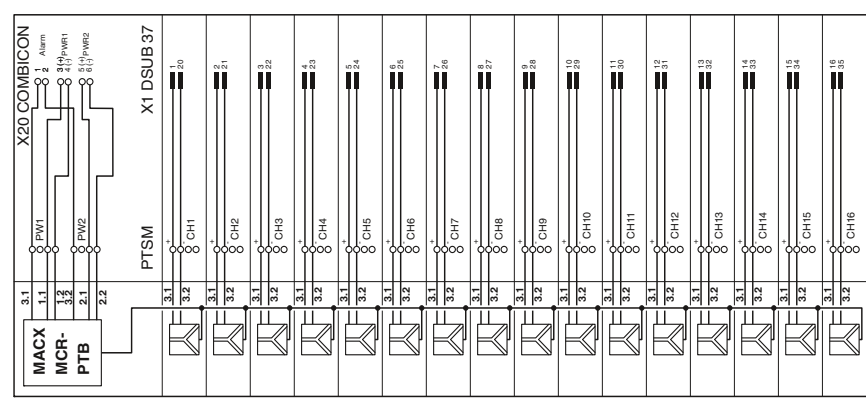

TC-D37SUB-ADIO16-EX-P-UNI and TC-D37SUB-AIO16-EX-PS-UNI connection scheme



Also for special applications

MCR Analog isolating amplifiers and digital displays – for special applications using signal processing.

Isolating amplifiers in the MCR Analog range can be used to record temperatures directly in the field, for example, or to convert digital signals into analog signals. You can monitor your process values using digital displays.

Choose the right MACX Analog isolating amplifier for your application:

Analog IN/Analog OUT

- Configurable signal multipliers to double standard analog signals
- Configurable loop-powered isolators and standard passive isolators for temperature
- Programmable temperature transducers
- Configurable temperature transducers for Pt 100
- Temperature relay for Pt 100
- Programmable loop-powered temperature transducers.

Frequency

- Programmable frequency transducers for frequencies of up to 120 kHz

Limit value switches

- Limit value switches for standard analog signals

Digital displays

- Programmable digital displays for standard signals
- Setpoint adjuster

Your advantages:

- High operational reliability in the event of disturbances, thanks to electrical isolation
- User-friendly wiring, thanks to plug-in connection terminal blocks
- Easy configuration via software, DIP switches or display keypad
- Digital displays can be programmed without software: via the keypad on the front
- The digital displays are easy to read, thanks to the large five-digit display

Analog IN / Analog OUT
3-way isolating amplifier

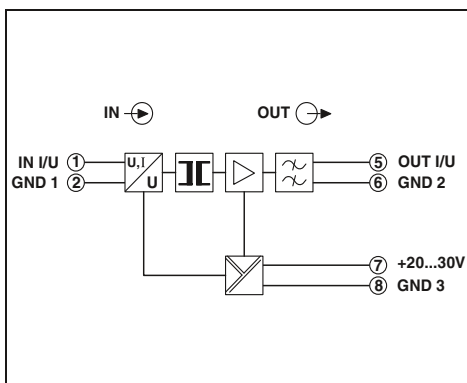
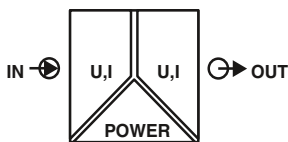

With fixed signal combinations



Housing width 12.5 mm

- Processing standard signals
- Fixed setting of input and output signals
- 3-way isolation

Notes:

1) EMC: Class A product, see page 571

Input data	Input signal Maximum input signal Input resistance
Output data	Output signal Maximum output signal Load R_B Linear transmission range (in reference to the output range end value)
General data	Supply voltage U_B Current consumption Maximum transmission error Temperature coefficient Limit frequency (3 dB) Step response (10 - 90%) Test voltage, input/output/supply Ambient temperature (operation) Mounting Housing material Dimensions W / H / D Screw connection solid / stranded / AWG
Conformance / approvals	Conformance

Technical data	
U input	I input
0 ... 10 V / -10 ... 10 V	0 ... 20 mA / 4 ... 20 mA
30 V	50 mA
100 k Ω	50 Ω
U output	I output
0 ... 10 V / -10 ... 10 V	0 ... 20 mA / 4 ... 20 mA
15 V	30 mA
≥ 10 k Ω	≤ 500 Ω
0% ... 105% -110% ... 110% (Bipolar signals)	-5% ... 105%
20 V DC ... 30 V DC	
< 15 mA (without load)	
$\leq 0.3\%$ (of final value), typ. < 0.2% (of final value)	
< 0.015%/K	
30 Hz	
11 ms	
1.5 kV (50 Hz, 1 min.)	
-25°C ... 60°C	
Any	
Polyamide PA non-reinforced	
12.5 / 99 / 114.5 mm	
0.2 ... 2.5 mm ² / 0.2 ... 2.5 mm ² / 24 - 14	
CE-compliant	

Description	
MCR 3-way isolating amplifier , for electrical isolation of analog signals,	
Input signal	Output signal
0 ... 10 V	4 ... 20 mA
4 ... 20 mA	0 ... 10 V
0 ... 10 V, -10 ... 10 V	0 ... 10 V, -10 ... 10 V
0 ... 20 mA, 4 ... 20 mA	0 ... 20 mA, 4 ... 20 mA

Ordering data		
Type	Order No.	Pcs. / Pkt.
MCR-C-U-I- 4-DC¹⁾	2814537	5
MCR-C-I-U- 4-DC¹⁾	2814511	5
MCR-C-U-U-DC¹⁾	2814469	5
MCR-C-I-I-00-DC¹⁾	2814508	5

Analog IN/Analog OUT signal multiplier

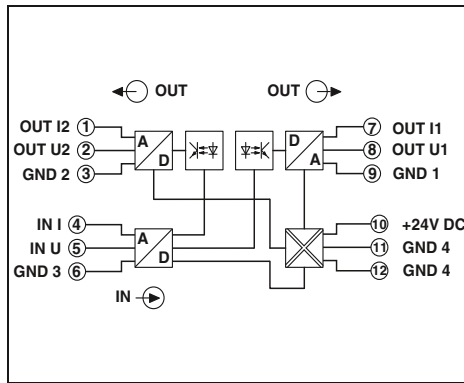
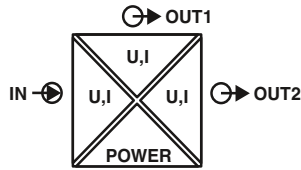

With freely configurable input and two outputs



Ex: Housing width 17.5 mm

- 4-way isolation
- Calibrated reversible input and output signals

Notes:
To order a product with an order configuration, enter the required configuration by referring to the adjacent order key.
1) EMC: Class A product, see page 571

Input data	Input signal
Measuring range span	Maximum input signal
Input resistance	200 kΩ
Output data	Output signal (configurable using the DIP switch)
Maximum output signal	Load R_B
General data	Supply voltage U_B
	Current consumption
	Maximum transmission error
	Temperature coefficient
	Test voltage, input/output/supply
	Degree of protection
	Ambient temperature (operation)
	Housing material
	Dimensions W / H / D
	Screw connection solid / stranded / AWG
Conformance / approvals	Conformance
	UL, USA / Canada

Technical data	
U input	I input
0 V ... 12 V (freely selectable in 0.1 V steps)	0 mA ... 24 mA (freely selectable in 0.1 mA steps)
min. 4 V	min. 8 mA
30 V	50 mA
200 kΩ	50 Ω
U output	I output
refer to the order key	refer to the order key
15 V	35 mA
≥ 10 kΩ	≤ 600 Ω
Supply data	
20 V DC ... 30 V DC	
< 25 mA	
≤ 0.15% (of final value), typ. 0.05% (of final value)	
< 0.015%/K, typ. 0.0075%/K	
1.5 kV (50 Hz, 1 min.)	
IP20	
-25°C ... 55°C	
Polyamide PA non-reinforced	
17.5 / 99 / 114.5 mm	
0.2 ... 2.5 mm ² / 0.2 ... 2.5 mm ² / 24 - 14	
CE-compliant	
Class I, Div. 2, Groups A, B, C, D or non-hazardous locations	

Description
MCR signal multiplier , for multiplication and electrical isolation of analog signals, Order configuration Standard configuration

Ordering data		
Type	Order No.	Pcs. / Pkt.
MCR-FL-C-UI-2UI-DCI¹⁾	2814854	1
MCR-FL-C-UI-2UI-DCI-NC¹⁾	2814867	1

Order key for MCR-FL-C-UI-2UI-DCI (standard configuration entered as an example)

Order No.	Input signal	Input signal (standard and special signals)		Output signal (standard signals)		Factory calibration certificate (FCC)
		Initial value	Final value	Output 1	Output 2	
2814854	I I ≙ Current U ≙ Voltage	0.0 0.0 ≙ 0.0 mA I : freely selectable between 0.0 ... 24.0 mA U : freely selectable between 0.0 ... 12.0 V	20.0 20.0 ≙ 20.0 mA I : freely selectable between 0.0 ... 24.0 mA U : freely selectable between 0.0 ... 12.0 V	OUT01 OUT01 ≙ 0...20 mA OUT02 ≙ 4...20 mA OUT03 ≙ 0...10 V OUT04 ≙ 2...10 V OUT05 ≙ 0...5 V OUT06 ≙ 1...5 V OUT16 ≙ 0...10 mA	OUT01 OUT01 ≙ 0...20 mA OUT02 ≙ 4...20 mA OUT03 ≙ 0...10 V OUT04 ≙ 2...10 V OUT05 ≙ 0...5 V OUT06 ≙ 1...5 V OUT16 ≙ 0...10 mA	NONE NONE ≙ without FCC YES ≙ with FCC (a fee is charged) YESPLUS ≙ FCC with 5 measuring points (a fee is charged)

**8.0 mA/4.0 V min. measuring range span
0.1 mA/0.1 V increment**

Ordering examples:

Order No.	Input signal	Input signal (standard and special signals)		Output signal (standard signals)		Factory calibration certificate (FCC)
		Initial value	Final value	Output 1	Output 2	
2814854	I I ≙ Current	5.3 I ≙ 5.3 mA	13.3 I ≙ 13.3 mA	OUT01 OUT01 ≙ 0...20 mA	OUT01 OUT01 ≙ 0...20 mA	NONE NONE ≙ without FCC

8.0 mA measuring range span, i.e., order is possible.

Order No.	Input signal	Input signal (standard and special signals)		Output signal (standard signals)		Factory calibration certificate (FCC)
		Initial value	Final value	Output 1	Output 2	
2814854	U U ≙ Voltage	7.8 U ≙ 7.8 V	11.8 U ≙ 11.8 V	OUT01 OUT01 ≙ 0...20 mA	OUT03 OUT03 ≙ 0...10 V	NONE NONE ≙ without FCC

4.0 V measuring range span, i.e., order is possible.

Combination table for input and output signals that can be set via DIP switches

Input	Output 1						Output 2							
	0...20 mA	4...20 mA	0...10 mA	0...10 V	0...5 V	1...5 V	2...10 V	0...20 mA	4...20 mA	0...10 mA	0...10 V	0...5 V	1...5 V	2...10 V
0...20 mA	x	x	x	x	x	x	x	x	x	x	x	x	x	x
4...20 mA	x	x	x	x	x	x	x	x	x	x	x	x	x	x
0...10 mA	x	x	x	x	x	x	x	x	x	x	x	x	x	x
2...10 mA	x	x	x	x	x	x	x	x	x	x	x	x	x	x
0...10 V	x	x	x	x	x	x	x	x	x	x	x	x	x	x
2...10 V	x	x	x	x	x	x	x	x	x	x	x	x	x	x
0...5 V	x	x	x	x	x	x	x	x	x	x	x	x	x	x
1...5 V	x	x	x	x	x	x	x	x	x	x	x	x	x	x

Application example: level measurement with subsequent signal multiplication

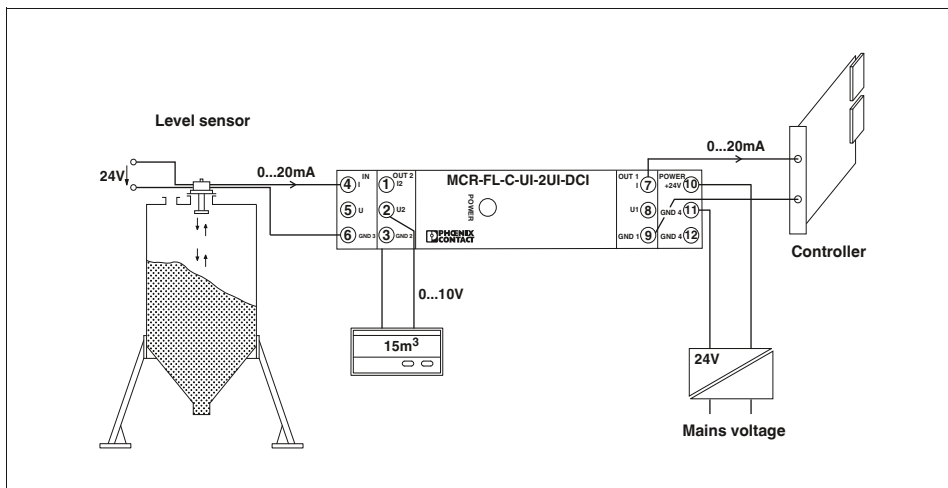

Analog IN / Analog OUT passive isolators

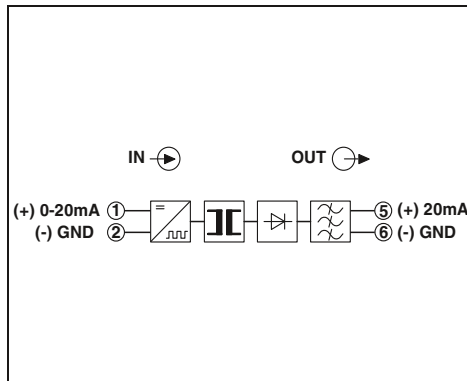
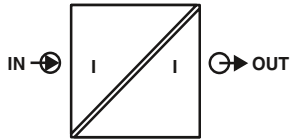

1-channel,
with safe isolation

Housing width 12.5 mm

- Electrical isolation without additional auxiliary power supply
- Current signals 0(4)...20 mA
- Safe isolation

Notes:

When using passive isolators, make sure that the current sourcing voltage of the measuring transducer U_B is sufficient to drive the maximum current of 20 mA via the passive isolator with the voltage drop $U_V = 2.5$ V and the load R_B .
This means:
 $U_B \geq U_V + 20 \text{ mA} \times R_B$

Technical data

Input data

Input signal
Voltage drop
Response current
Maximum input current
Maximum input voltage
Input voltage limitation

0 ... 20 mA / 4 ... 20 mA
2.5 V (at I = 20 mA)
< 50 μ A
50 mA (100 mA overload)
30 V (30 V overload)
33 V 5% (with Zener diode)

Output data

Output signal
Maximum output signal
Load R_B

0 ... 20 mA / 4 ... 20 mA
< 50 mA
 $\leq 1375 \Omega$ (at I = 20 mA output signal)

Ripple

< 5 mV (rms)

General data

Maximum transmission error
Additional error per 100 Ω load
Temperature coefficient
Test voltage input/output
Protection against electric shock

$\leq 0.1\%$ (of final value)
0.02% (of measured value / 100 Ω load)
 $\leq 0.002\%/K$ (of measured value / 100 Ω load)
4 kV (50 Hz, 1 min.)

Increased insulation according to DIN EN 61 010 part 1 and safe isolation according to VDE 0100 part 410 along the lines of VDE 0106 part 101 up to 300 V AC/DC for surge voltage category II and pollution degree 2 between all isolated distances.

Ambient temperature (operation)

-10°C ... 70°C

Housing material

Polyamide PA non-reinforced

Dimensions W / H / D

12.5 / 99 / 114.5 mm

Screw connection solid / stranded / AWG

0.2 ... 2.5 mm² / 0.2 ... 2.5 mm² / 24 - 14

Conformance / approvals

CE-compliant

Conformance

Ordering data

Description

MCR passive isolator, for electrical isolation of current signals without auxiliary power

Type	Order No.	Pcs. / Pkt.
MCR-SL-1CLP-I-I-00-4KV	2814841	1

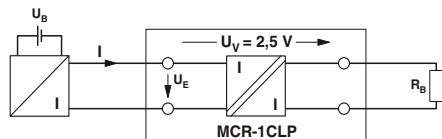

Input voltage in relation to load for $I_A = 20$ mA

The diagram shows input voltage U_i in relation to load R_B taking into account voltage failure U_V .
If the load is known, the minimum voltage the sensor must supply in order to drive the maximum current of 20 mA via the passive isolator and the load can be read on the Y-axis.

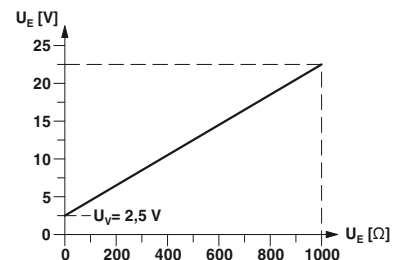

Analog IN / Analog OUT
passive isolators

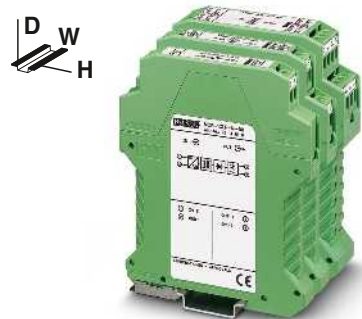
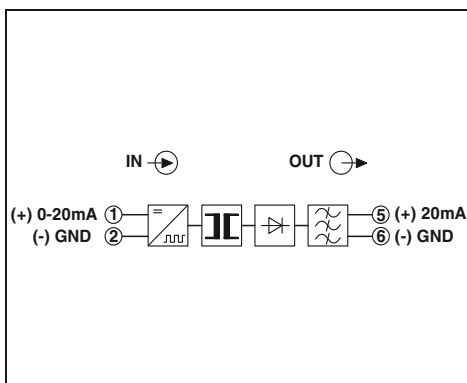
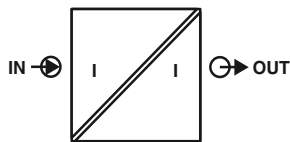

1-, 2- or 4-channel options

- Electrical isolation without additional auxiliary power supply
- Current signals 0(4)...20 mA
- Alternatively 1-, 2- or 4-channel version

Notes:

When using passive isolators, make sure that the current sourcing voltage of the measuring transducer U_B is sufficient to drive the maximum current of 20 mA via the passive isolator with the voltage drop $U_V = 2.5 \text{ V}$ and the load R_B .
This means:
 $U_B \geq U_E = 2.5 \text{ V} + 20 \text{ mA} \times R_B$

Input data	Input signal Voltage drop Response current Maximum input current Maximum input voltage Input voltage limitation
Output data	Output signal Maximum output signal Load R_B
Ripple	< 5 mV (rms)
General data	Additional error per 100 Ω load Temperature coefficient
Test voltage input/output	510 V (50 Hz, 1 min.)
Ambient temperature (operation)	-10°C ... 70°C
Housing material	Polyamide PA non-reinforced
Dimensions H / D	99 / 114.5 mm
Screw connection solid / stranded / AWG	0.2 ... 2.5 mm ² / 0.2 ... 2.5 mm ² / 24 - 14
Conformance / approvals	CE-compliant

Technical data		
Input data	0 ... 20 mA / 4 ... 20 mA	
Voltage drop	2.5 V (at I = 20 mA)	
Response current	< 50 μA	
Maximum input current	50 mA (100 mA overload)	
Maximum input voltage	30 V (30 V overload)	
Input voltage limitation	33 V (with Zener diode)	
Output data	0 ... 20 mA / 4 ... 20 mA	
Output signal	< 50 mA	
Maximum output signal	$\leq 1375 \Omega$ (at I = 20 mA output signal)	
Ripple	< 5 mV (rms)	
Additional error per 100 Ω load	0.02% (of measured value)	
Temperature coefficient	$\leq 0.002\%/K$ (of measured value / 100 Ω load)	
Test voltage input/output	510 V (50 Hz, 1 min.)	
Ambient temperature (operation)	-10°C ... 70°C	
Housing material	Polyamide PA non-reinforced	
Dimensions H / D	99 / 114.5 mm	
Screw connection solid / stranded / AWG	0.2 ... 2.5 mm ² / 0.2 ... 2.5 mm ² / 24 - 14	
Conformance / approvals	CE-compliant	

Description	MCR passive isolator , for electrical isolation of current signals without auxiliary power
1-channel	12.5 mm wide
2-channel	12.5 mm wide
4-channel	22.5 mm wide

Ordering data		
Type	Order No.	Pcs. / Pkt.
MCR-1CLP-I-I-00	2814016	1
MCR-2CLP-I-I-00	2814029	1
MCR-4CLP-I-I-00	2814045	1

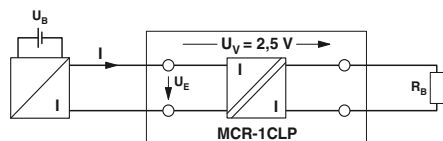

Flow measurement

Magnetic inductive flow sensor

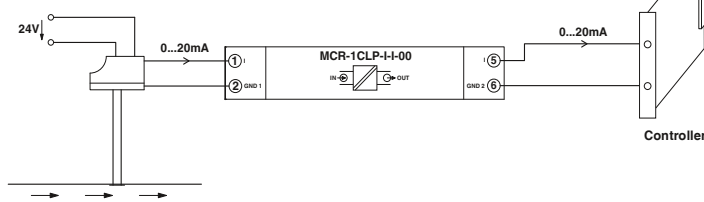

Temperature

Temperature transducer

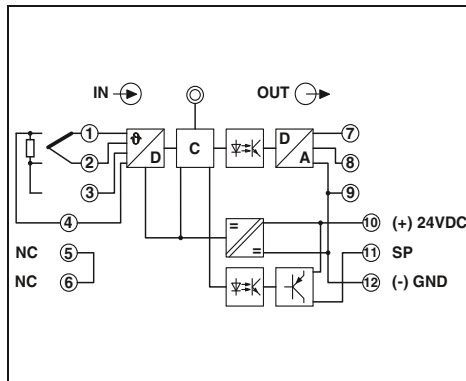
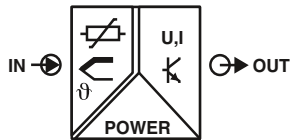

For resistance thermometers, thermocouples, resistance-type sensors, and mV sources



Ex: (UL)

Housing width 17.5 mm

- For resistance thermometers and thermocouples
- Measure differential temperatures
- With transistor switching output
- Freely programmable via MCR/PI-CONF-WIN
- Option of inverse output signal ranges

Notes:
To order a product with an order configuration, enter the required configuration by referring to the adjacent order key.
Further information about the configuration software can be found on page 149
1) EMC: Class A product, see page 571

Input data
Resistance thermometers
Thermocouple sensors
Resistor
Voltage
Temperature range
Sensor input current
Output data
Output signal
Maximum output signal
D/A resolution
Load R_B
Ripple
Output signal with open circuit
Measuring range overrange/underrange
Switching output

Technical data	
Pt, Ni, Cu sensors : 2, 3, 4-conductor	
U, T, L, J, E, K, N, S, R, B, C, W, HK	
0 Ω ... 8000 Ω (freely adjustable, min. measuring range 100 Ω)	
-20 mV ... 2400 mV (freely adjustable, minimum measuring range span of 10 mV) (Depending on sensor type used)	
250 μ A (resistance thermometer)	
U output	I output
0 ... 5 V / 0 ... 10 V	0 ... 20 mA / 4 ... 20 mA
-5 ... 5 V / -10 ... 10 V	-
± 12 V	24 mA
± 12 bit	± 12 bit
≥ 10 k Ω	≤ 500 Ω
< 20 mV _{pp}	
-12 V ... 12 V	0 A ... 24 mA
-12 V ... 12 V	0 A ... 24 mA
Transistor output, pnp	
Can carry a load of 100 mA, switches supply voltage (not protected against short-circuit); locked in case of order-specific configuration, otherwise freely programmable through MCR/PI-CONF-WIN	

General data
Supply voltage U_B
Current consumption
Maximum transmission error
Cold junction errors
Temperature coefficient
Test voltage input/output
Test voltage input/power supply
Ambient temperature (operation)
Mounting
Housing material
Dimensions W / H / D
Screw connection solid / stranded / AWG
Conformance / approvals
Conformance
UL, USA / Canada
GL

18 V DC ... 30 V DC
≤ 60 mA, typ. 40 mA
$\leq 0.1\%$ (of maximum range, ± 6 mV or ± 12 μ A at output)
≤ 3 K, typ. 1.5 K
$\leq 0.01\%/K$, typ. 0.005%/K
1 kV (50 Hz, 1 min.)
1 kV (50 Hz, 1 min.)
-20°C ... 65°C
Any
Polyamide PA non-reinforced
17.5 / 99 / 114.5 mm
0.2 ... 2.5 mm ² / 0.2 ... 2.5 mm ² / 24 - 14
CE-compliant
Class I, Div. 2, Groups A, B, C, D or non-hazardous locations
Germanischer Lloyd

Description
MCR temperature measuring transducers , for resistance thermometers and thermocouple sensors, with electrical isolation of input/output and input/supply voltage
Order configuration
Standard configuration
Order configuration, without electrical isolation
Standard configuration, without electrical isolation

Ordering data		
Type	Order No.	Pcs. / Pkt.
MCR-T-UI-E ¹)	2814113	1
MCR-T-UI-E-NC ¹)	2814126	1
MCR-T-UI ¹)	2814090	1
MCR-T-UI-NC ¹)	2814100	1

Order key for MCR-T-UI(-E)... (standard configuration entered as an example)

Order No.	Sensor type	Input characteristic curve	Connection technology	Measuring range:		Measuring unit	Output	Output characteristic curve	Factory calibration certificate (FCC)
				Start	End				
2814113	PT100	D	3	-200.0	+850.0	C	OUT02	N	NONE
2814113 ≙ MCR-T-UI-E	See tables under "Sensor type"	D ≙ DIN S ≙ SAMA (see table)	2 ≙ 2-conductor 3 ≙ 3-conductor 4 ≙ 4-conductor	for 0 mA (e.g., -200.0°C)	for 20 mA (e.g., +850.0°C)	C ≙ °C F ≙ °F V ≙ mV O ≙ W P ≙ %	OUT01 ≙ 0...20 mA OUT02 ≙ 4...20 mA OUT03 ≙ 0...10 V OUT05 ≙ 0...5 V OUT13 ≙ -5...+5 V OUT14 ≙ -10...+10 V	N ≙ Normal I ≙ Inverse	NONE ≙ without FCC YES ≙ with FCC (a fee is charged)
2814090 ≙ MCR-T-UI		0 ≙ for Ni1000 (Landis & Gyr), Cu10, Cu50, Cu53, KTY81-110, thermocouple, resistor, potentiometer, voltage	0 ≙ for thermocouple, resistor, potentiometer, voltage						YESPLUS ≙ FCC with 5 measuring points (a fee is charged)

Resistance thermometers

Sensor type 1)	Standard (input characteristic curve)	Measuring range	Smallest measuring range span
PT...	DIN/SAMA	-200°C ... 850°C	0.4 K
NL...	DIN/SAMA	-60°C ... 180°C	0.4 K
Ni1000	Landis & Gyr	-50°C ... 160°C	0.4 K
CU10	SAMA	-70°C ... 500°C	0.4 K
CU50	-	-50°C ... 200°C	0.4 K
CU53	-	-50°C ... 180°C	0.4 K
KTY81	Philips	-55°C ... 150°C	0.4 K
KTY84	-	-40°C ... 300°C	0.4 K

Temperature ranges according to IEC 60751/EN 60751 and DIN 43760 SAMA RC 21-4-1966 with 2, 3 or 4-conductor circuit.

1) Note: Pt sensors in increments of 10, 20, ...100 and 100, 200, ...1000, 2000.
KTY81 ≙ KTY81-110.

Other types or characteristic curves available on request.

Thermocouples

Sensor type	Thermocouple	Measuring range	Smallest measuring range span
U	Cu-CuNi	-200°C ... 600°C	> 1 K
T 2)	Cu-CuNi	-200°C ... 400°C	> 1 K
L	Fe-CuNi	-200°C ... 900°C	> 1 K
J 2)	Fe-CuNi	-210°C ... 1200°C	> 1 K
E 2)	NiCr-CuNi	-226°C ... 1000°C	> 1 K
K 2)	NiCr-Ni	-200°C ... 1372°C	> 1 K
N 2)	NiCrSi-NiSi	-200°C ... 1300°C	> 1 K
S 2)	Pt10Rh-Pt	-50°C ... 1768°C	> 4 K
R 2)	Pt13Rh-Pt	-50°C ... 1768°C	> 4 K
B 2)	Pt30Rh-Pt6Rh	500°C ... 1820°C	> 10 K
C	-	-18°C ... 2316°C	> 4 K
W	-	-18°C ... 2316°C	> 4 K
HK	-	-200°C ... 800°C	> 1 K

2) Thermocouples according to IEC 60584/EN 60584.

Other types or characteristic curves available on request.

Resistors, potentiometers, mV voltages

Sensor type	Input	Measuring range	Smallest measuring range span
RES	Resistor	0 Ω ... 8000 Ω (2-conductor)	2 Ω
POT	Potentiometer (max. 8 kΩ)	0 ... 100% (3-conductor)	0.2%
V01	Voltage	-20 mV ... +2400 mV	2 mV

Temperature conversion guide for °C to °F:

$$T [°F] = \frac{9}{5} T [°C] + 32$$

Ordering examples with different input versions:

Resistance thermometer

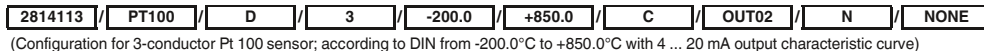

Thermocouple

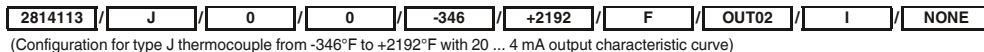

Voltage

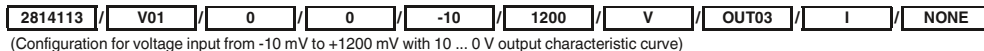

Resistor

(2-conductor connection)

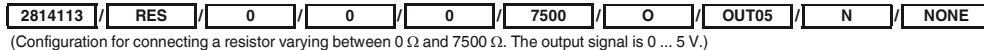

Potentiometer

(3-conductor connection)

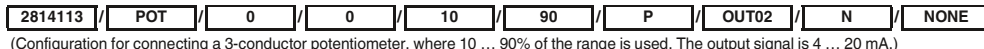

Application examples:

Resistance thermometer: 2-conductor connection technology

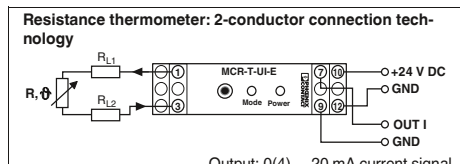

Application:

- For short distances (< 10 m)

Please note:

- Cable resistances R_{L1} and R_{L2} are incorporated in the measurement result directly and falsify the result accordingly (example for Pt 100: $0.385 \Omega \pm 1 K$). Compensation of $\pm 5\%$ is possible.

Resistance thermometer: 3-conductor connection technology

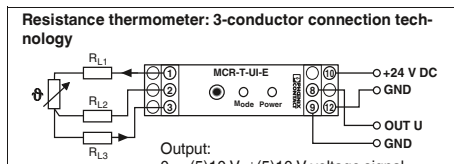

Application:

- For long distances between the Pt 100 sensor and the MCR module ($R_{L1}, R_{L2}, R_{L3} \leq 25 \Omega$)

Please note:

- To compensate the cable resistance, all cable resistances must have exactly the same values ($R_{L1} = R_{L2} = R_{L3}$)

Resistance thermometer: 4-conductor connection technology

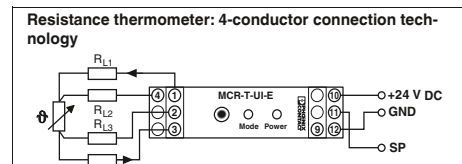

Application:

- For long distances between the Pt 100 sensor and the MCR module and different cable resistances ($R_{L1} \neq R_{L2} \neq R_{L3} \neq R_{L4}$)

Please note:

- The cable resistance ($R_{L2} + R_{L4}$) must not exceed a value of 50 Ω.

Potentiometer

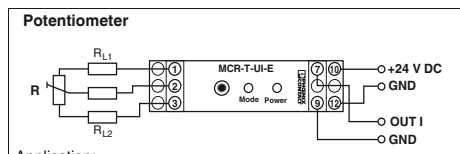

Application:

- For short distances and gradual changes.

Please note:

- Cable resistances R_{L1} and R_{L2} are incorporated in the measurement result directly and falsify the result accordingly. Compensation of $\pm 5\%$ is possible.

Thermocouple: absolute temperature measurement

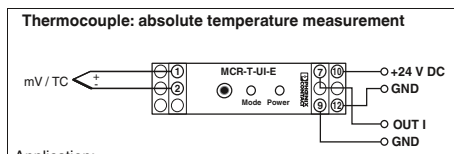

Application:

- Connecting a thermocouple or an mV signal.

Note:

- Activate cold junction compensation for the device in the case of thermocouple measurements.

Thermocouple: differential temperature measurement

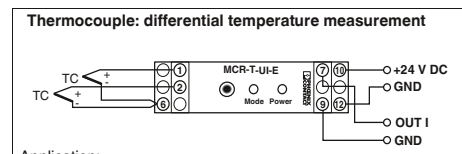

Application:

- Differential temperature measurement with thermocouples.
- Deactivate cold junction compensation for the device.

Temperature Temperature transducer

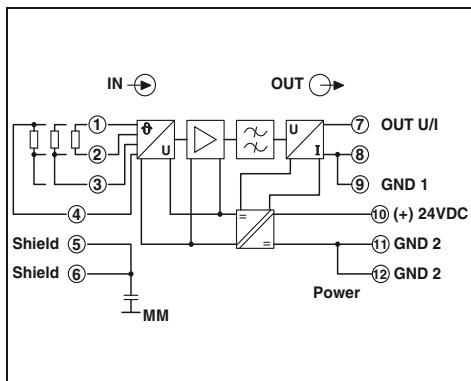
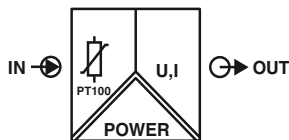

For Pt 100, either voltage or current output

Housing width 17.5 mm

- Temperature range adjustable via DIP switch
- ZERO/SPAN adjustment
- Open circuit detection
- Alternatively with galvanically isolated supply voltage

Notes:
When ordering, you must use the order key to specify the desired configuration.
1) EMC: Class A product, see page 571

Input data
Resistance thermometers
Temperature range
Sensor input current
Output data
Output signal
Maximum output signal
Load R_B
Output signal with open circuit
General data
Supply voltage U_B
Current consumption
Maximum transmission error
Temperature coefficient
ZERO / SPAN adjustment
Step response (10 - 90%)
Test voltage power supply/signal
Ambient temperature (operation)
Housing material
Dimensions W / H / D
Screw connection solid / stranded / AWG
Conformance / approvals
Conformance
UL, USA / Canada

Technical data				
Pt 100 (IEC 60751/EN 60751) : 2, 3, 4-conductor				
0°C ... 300°C (0 ... 100/150/200/300) / -50°C ... 250°C (-50 ... 50/100/150/250)				
Approx. 1 mA				
U output		I output		
0 ... 10 V	15 V	0 ... 20 mA / 4 ... 20 mA	30 mA	
$\geq 10 \text{ k}\Omega$	$> 11 \text{ V}$	$\leq 500 \Omega$	$> 22 \text{ mA}$	
...-U-DC	...-I-DC	...-U	...-I	
20 ... 30 V DC	20 ... 30 V DC	20 ... 30 V DC	20 ... 30 V DC	
35 mA	60 mA	20 mA	45 mA	
$\leq 0.4\%$ (of final value)				
$\leq 0.02\%/K$				
$\pm 5\% / \pm 5\%$				
11 ms				
750 V AC (50 Hz, 1 min.)				
-20°C ... 65°C				
Polyamide PA non-reinforced				
17.5 / 99 / 114.5 mm				
0.2 ... 2.5 mm ² / 0.2 ... 2.5 mm ² / 24 - 14				
CE-compliant				
UL 508 Recognized				

Description
MCR temperature measuring transducer , for Pt 100 temperature sensors with 2, 3, 4-conductor technology with electrically isolated supply voltage
Output: 0...0.10 V
Output: 0...(4)20 mA
Output: 0...10 V, without electrical isolation
Output: 0...(4)20 mA, without electrical isolation

Ordering data		
Type	Order No.	Pcs. / Pkt.
MCR-PT100-U-DC¹⁾	2810311	1
MCR-PT100-I-DC¹⁾	2810337	1
MCR-PT100-U¹⁾	2810340	1
MCR-PT100-I¹⁾	2810353	1

Order key MCR-PT100-...(DC) (standard configuration entered as example)

Order No.	Connection method	Temperature range	Output	Factory calibration certificate
2810337	3	TR05	OUT02	NONE
2810311 $\hat{=}$ MCR-PT100-U-DC	2 $\hat{=}$ 2-conductor	TR01 $\hat{=}$ -50...+50°C	OUT01 $\hat{=}$ 0...20 mA	NONE $\hat{=}$ Without certificate
2810337 $\hat{=}$ MCR-PT100-I-DC	3 $\hat{=}$ 3-conductor	TR02 $\hat{=}$ -50...+100°C	OUT02 $\hat{=}$ 4...20 mA	YES $\hat{=}$ With factory calibration certificate (fee)
2810340 $\hat{=}$ MCR-PT100-U	4 $\hat{=}$ 4-conductor	TR03 $\hat{=}$ -50...+150°C	With the devices: 2810311 MCR-PT100-U-DC 2810340 MCR-PT100-U The output signal is 0...10 V. No details are necessary.	YESPLUS $\hat{=}$ Factory calibration certificate with 5 measuring points (fee)
2810353 $\hat{=}$ MCR-PT100-I		TR04 $\hat{=}$ -50...+250°C		
		TR05 $\hat{=}$ 0...100°C		
		TR06 $\hat{=}$ 0...150°C		
		TR07 $\hat{=}$ 0...200°C		
		TR08 $\hat{=}$ 0...300°C		

Temperature
Temperature relay

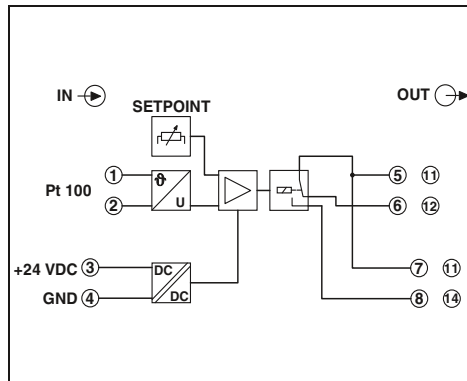
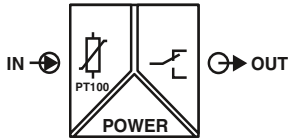

For Pt 100

Housing width 12.5 mm

- Switching point in the temperature range from -100°C ... +700°C freely selectable
- Changeover relay output
- Galvanically isolated
- Adjustable switch hysteresis

Notes:

1) EMC: Class A product, see page 571

Input data

Resistance thermometers
Temperature range
Sensor input current

Switching output

Contact type
Contact material
Maximum switching current

Operate delay time
Off delay time
Switching hysteresis

Error/status indicator

General data

Supply voltage U_B
Current consumption
Linearity error
Setting accuracy
Temperature coefficient
Test voltage, input/output/supply
Ambient temperature (operation)
Mounting
Housing material
Dimensions W / H / D
Screw connection solid / stranded / AWG
Conformance / approvals
Conformance
UL, USA / Canada

Technical data

Pt 100 (IEC 60751/EN 60751) : 2-conductor

-100°C ... 700°C

Approx. 1 mA

Relay output

1 PDT

AgSnO, hard gold-plated

50 mA (for gold layer, 30 V AC/ 36 V DC)

2 A (in case of a destroyed gold layer, 250 V AC)

Approx. 6 ms

Approx. 200 ms

Adjustable using DIP switches (0.5 K, 2 K, 3 K, 5 K)

Red LED (short-circuit/wire break) / Yellow LED (relay active)

20 V DC ... 30 V DC

< 30 mA

< 0.1%

< 1%, typ. < 0.5%

< 0.01%/K, typ. 0.005%/K

1.5 kV (50 Hz, 1 min.)

-20°C ... 65°C

Any

Polyamide PA non-reinforced

12.5 / 99 / 114.5 mm

0.2 ... 2.5 mm² / 0.2 ... 2.5 mm² / 24 - 14

CE-compliant

UL 508 Recognized

Ordering data

Description

MCR temperature relay, for Pt 100 in 2-conductor system

Type

MCR-SL-PT100-SP¹⁾

Order No.

2814948

Pcs. / Pkt.

1

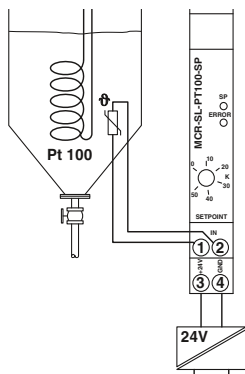

Application example - Temperature control of a heated medium
1 = mains voltage

Temperature

Temperature transducer

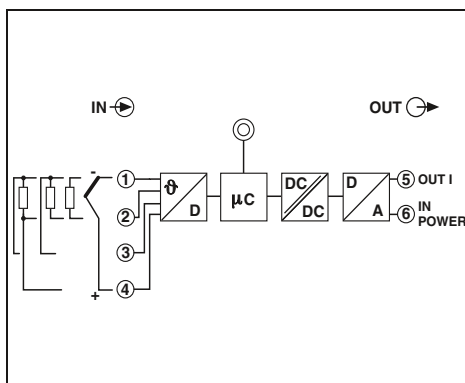
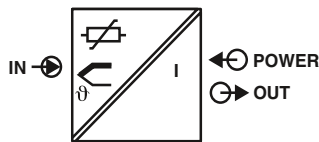

Loop-powered, programmable



Ex: Housing width 12.5 mm

- Two-wire transmitter for resistance thermometers, thermocouples, resistance-type, and voltage sensors
- Freely programmable via MCR/PI-CONF-WIN

Notes:
 The devices are supplied with the standard configuration: Pt 100 sensor, measuring range 0 ... 100°C, 3-cond. connection.
 You can implement your own measuring range settings, linearization, and characteristic curve adjustments. For this purpose, you need the MCR-PAC-T-USB programming adapter and the MCR/PI-CONF-WIN configuration software, see page 149

Input data	
Resistance thermometers	
Thermocouple sensors	
Resistor	
Voltage	
Output data	
Output signal	
Load R_B	
Output signal with short-circuit	
Output signal with open circuit	
Measuring range overrange/underrange	
General data	
Supply voltage U_B	12 V DC ... 35 V DC
Current consumption	< 3.5 mA
Transmission error	Resistance thermometers 0.2 K (Pt 100, Ni 100), 0.5 K (Pt 500, Ni 500), 0.3 K (Pt 1000, Ni 1000) Thermocouple sensors Type 0.5 K (K, J, T, E, L, U), 1.0 K (N, C, D), 2.0 K (S, B, R) Resistance-type sensors $\pm 0.1 \Omega$ (10...400 Ω), $\pm 1.5 \Omega$ (10...2000 Ω) Voltage sensor $\pm 20 \mu V$ (-10...100 mV)
Step response (10 - 90%)	< 2 s
Pickup delay	4 s
Test voltage input/output	2 kV (50 Hz, 1 min.)
Degree of protection	IP20
Ambient temperature (operation)	-40°C ... 85°C
Mounting	Any
Housing material	Polyamide PA non-reinforced
Dimensions W / H / D	12.5 / 99 / 114.5 mm
Screw connection solid / stranded / AWG	0.2 ... 2.5 mm ² / 0.2 ... 2.5 mm ² / 24 - 14
Conformance / approvals	
Conformance	CE-compliant
UL, USA / Canada	Class I, Div. 2, Groups A, B, C, D

Technical data

Pt, Ni (100, 500, 1000);
 minimum measurement range 10 K : 2, 3, 4-conductor
 B, C, D, E, J, K, L, N, R, S, T, U;
 minimum measurement range 50 K/500 K
 (Resistance-type sensor from 10 Ω to 400 Ω and from 10 Ω to 2000 Ω ;
 minimum measurement range 10 Ω /100 Ω)
 -10 mV ... 100 mV (min. measurement range 5 mV)
 4 ... 20 mA / 20 ... 4 mA
 (Max ($V_{supply} - 12 V$) / 0.023 A (current output))
 ≤ 3.6 mA or ≥ 21 mA (adjustable, not for thermocouples)
 ≤ 3.6 mA or ≥ 21 mA (adjustable)
 ≤ 20.5 mA / ≥ 3.8 mA (linear increase/decrease)

Description
MCR temperature measuring transducer, loop-powered
for resistance thermometers, thermocouples, resistance-type, and voltage sensors

Ordering data

Type	Order No.	Pcs. / Pkt.
MCR-FL-T-LP-I	2864561	1

Temperature
Temperature transducer

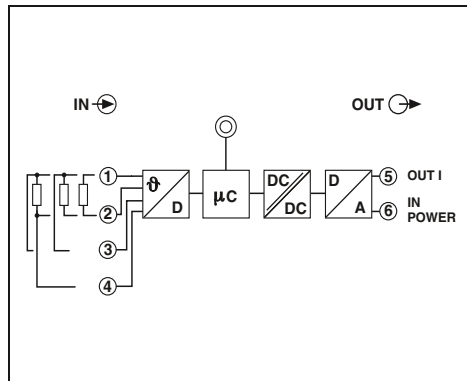
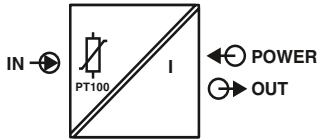

Loop-powered,
programmable



Ex: Housing width 12.5 mm

- Two-wire transmitter for Pt 100 resistance thermometers
- Freely programmable via MCR/PI-CONF-WIN

Notes:

The devices are supplied with the standard configuration: Pt 100 sensor, measuring range 0 ... 100°C, 3-cond. connection.

You can implement your own measuring range settings, linearization, and characteristic curve adjustments. For this purpose, you need the MCR-PAC-T-USB programming adapter and the MCR/PI-CONF-WIN configuration software, see page 149

Input data

Resistance thermometers

Output data

Output signal

Load R_B

Output signal with short-circuit

Output signal with open circuit

Measuring range overrange/underrange

General data

Supply voltage U_B

Current consumption

Transmission error

Step response (10 - 90%)

Pickup delay

Test voltage input/output

Degree of protection

Ambient temperature (operation)

Mounting

Housing material

Dimensions W / H / D

Screw connection solid / stranded / AWG

Conformance / approvals

Conformance

UL, USA / Canada

Resistance thermometers

Technical data

Pt 100 ; minimum measurement range 10 K : 2, 3, 4-conductor

4 ... 20 mA / 20 ... 4 mA
(Max (V_{supply} -12 V) / 0.023 A (current output))

≤ 3.6 mA or ≥ 21 mA (adjustable)

≤ 3.6 mA or ≥ 21 mA (adjustable)

≤ 20.5 mA / ≥ 3.8 mA (linear increase/decrease)

12 V DC ... 35 V DC

< 3.5 mA

0.2 K

< 2 s

4 s

2 kV (50 Hz, 1 min.)

IP20

-40°C ... 85°C

Any

Polyamide PA non-reinforced

12.5 / 99 / 114.5 mm

0.2 ... 2.5 mm² / 0.2 ... 2.5 mm² / 24 - 24

CE-compliant

Class I, Div. 2, Groups A, B, C, D

Ordering data

Description

MCR temperature measuring transducer, loop-powered

for Pt 100 resistance thermometer

Type

MCR-SL-PT100-LP-I

Order No.

2864558

Pcs. / Pkt.

1

Temperature

Temperature head transmitter

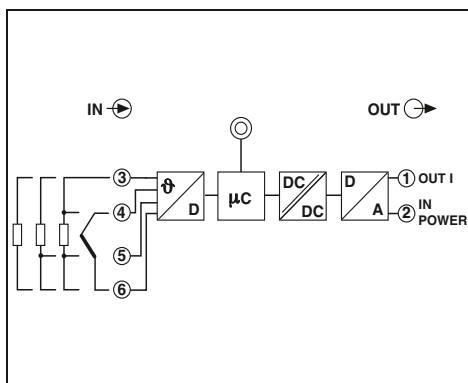
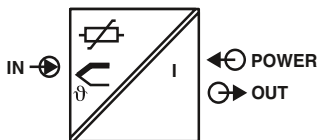

Loop-powered, programmable



- Two-wire transmitter for resistance thermometers, thermocouples, resistance-type, and voltage sensors
- For mounting in the connecting head, form B
- Freely programmable via MCR/PI-CONF-WIN

Notes:
 The devices are supplied with the standard configuration: Pt 100 sensor, measuring range 0 ... 100°C, 3-cond. connection.
 You can implement your own measuring range settings, linearization, and characteristic curve adjustments. For this purpose, you need the MCR-PAC-T-USB programming adapter and the MCR/PI-CONF-WIN configuration software, see page 149

Input data	Resistance thermometers
	Thermocouple sensors
	Resistor
Voltage	
Output data	
Output signal	
Load R_B	
Output signal with short-circuit	
Output signal with open circuit	
Measuring range overrange/underrange	
General data	
Supply voltage U_B	Resistance thermometers
Current consumption	Thermocouple sensors
Transmission error	Resistance-type sensors
	Voltage sensor
Step response (10 - 90%)	< 2 s
Pickup delay	6 s
Test voltage input/output	2 kV (50 Hz, 1 min.)
Degree of protection	IP00, IP66 (integrated in the connecting head)
Ambient temperature (operation)	-40°C ... 85°C
Mounting	Any
Housing material	Polycarbonate, PC
Screw connection solid / stranded / AWG	0.2 ... 1.75 mm ² / 0.2 ... 1.75 mm ² / 24 - 15
Conformance / approvals	
Conformance	CE-compliant
UL, USA / Canada	Class I, Div. 2, Groups A, B, C, D

Technical data	
	Pt, Ni (100, 500, 1000); minimum measurement range 10 K : 2, 3, 4-conductor B, C, D, E, J, K, L, N, R, S, T, U; minimum measurement range 50 K/500 K (Resistance-type sensor from 10 Ω to 400 Ω and from 10 Ω to 2000 Ω; minimum measurement range 10 Ω/100 Ω)
	-10 mV ... 75 mV (min. measurement range 5 mV)
	4 ... 20 mA / 20 ... 4 mA (Max (V _{supply} - 8 V) / 0.025 A (current output))
	≤ 3.6 mA or ≥ 21 mA (adjustable, not for thermocouples)
	≤ 3.6 mA or ≥ 21 mA (adjustable) ≤ 20.5 mA / ≥ 3.8 mA (linear increase/decrease)
General data	
	8 V DC ... 35 V DC
	< 3.5 mA
	0.2 K (Pt 100, Ni 100), 0.5 K (Pt 500, Ni 500), 0.3 K (Pt 1000, Ni 1000)
	Type 0.5 K (K, J, T, E, L, U), 1.0 K (N, C, D), 2.0 K (S, B, R)
	±0.1 Ω (10...400 Ω), ±1.5 Ω (10...2000 Ω)
	±20 µV (-10...100 mV)
	< 2 s
	6 s
	2 kV (50 Hz, 1 min.)
	IP00, IP66 (integrated in the connecting head)
	-40°C ... 85°C
	Any
	Polycarbonate, PC
	0.2 ... 1.75 mm ² / 0.2 ... 1.75 mm ² / 24 - 15
	CE-compliant
	Class I, Div. 2, Groups A, B, C, D

Description
MCR temperature measuring transducer, loop-powered
for resistance thermometers, thermocouples, resistance-type, and voltage sensors

Ordering data		
Type	Order No.	Pcs. / Pkt.
MCR-FL-HT-T-I	2864529	1

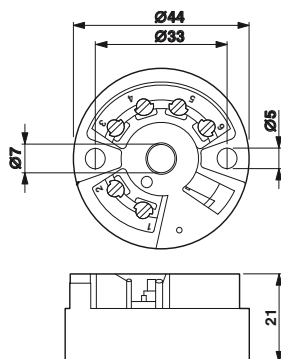

Temperature
Temperature head transmitter

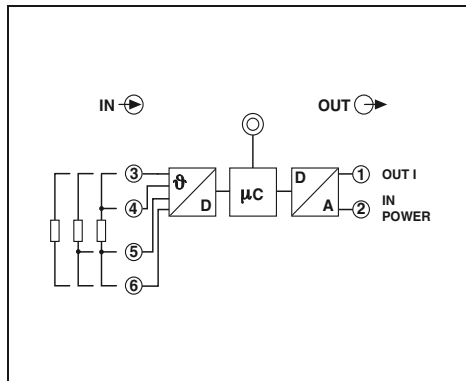
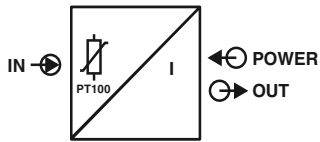

Loop-powered,
programmable



- Two-wire transmitter for Pt 100 resistance thermometers
- For mounting in the connecting head, form B
- Freely programmable via MCR/PI-CONF-WIN

Notes:

The devices are supplied with the standard configuration: Pt 100 sensor, measuring range 0 ... 100°C, 3-cond.connection.

You can implement your own measuring range settings, linearization, and characteristic curve adjustments. For this purpose, you need the MCR-PAC-T-USB programming adapter and the MCR/PI-CONF-WIN configuration software, see page 149

Input data

Resistance thermometers

Output data

Output signal
Load R_B

Output signal with short-circuit
Output signal with open circuit
Measuring range overrange/underrange

General data

Supply voltage U_B
Current consumption
Transmission error
Step response (10 - 90%)
Pickup delay
Degree of protection
Ambient temperature (operation)
Mounting
Housing material
Conformance / approvals
Conformance
UL, USA / Canada

Resistance thermometers

Technical data

Pt 100 ; minimum measurement range 10 K : 2, 3, 4-conductor

4 ... 20 mA / 20 ... 4 mA
(Max $(V_{supply} - 10 V) / 0.023 A$ (current output))

$\leq 3.6 \text{ mA}$ or $\geq 21 \text{ mA}$ (adjustable)
 $\leq 3.6 \text{ mA}$ or $\geq 21 \text{ mA}$ (adjustable)
 $\leq 20.5 \text{ mA}$ / $\geq 3.8 \text{ mA}$ (linear increase/decrease)

10 V DC ... 35 V DC
< 3.5 mA

0.2 K
< 2 s
4 s
IP00, IP54 (integrated in the connecting head)
-40°C ... 85°C
Any
Polycarbonate, PC

CE-compliant
Class I, Div. 2, Groups A, B, C, D

Ordering data

Description

MCR temperature measuring transducer, loop-powered
for Pt 100 resistance thermometer

Type

MCR-SL-HT-PT 100-I

Order No.

2864516

Pcs. / Pkt.

1

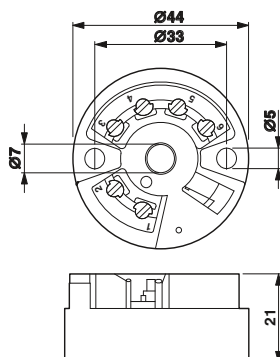

Frequency Frequency transducer

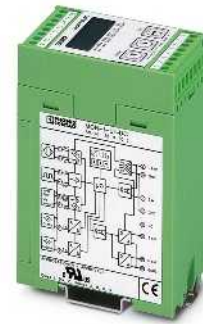
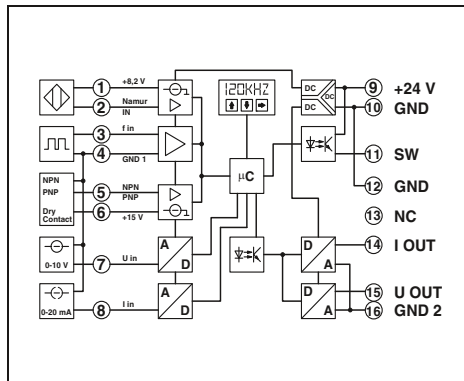
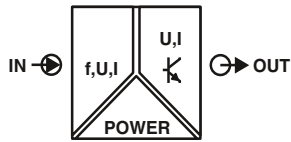

**Programmable,
for frequencies of up to 120 kHz**



EX: (UL)

Housing width 45 mm

- Frequencies up to 120 kHz
- For NAMUR sensors, floating contacts, frequency generators, and NPN/PNP transistor outputs
- Analog and switching output
- 3-way isolation
- Programmable using membrane keypad or software
- Display of input or output signal

Notes:
Further information about the configuration software can be found on page 149
1) EMC: Class A product, see page 571

Input data	Frequency range Input sources
Transducer supply	Signal level
Maximum input signal	Signal form Pulse length Resolution Signal conversion time
Input data	Input signal
Maximum input signal	Input resistance Resolution
Output data	Output signal Maximum output signal Load R_B Ripple
Switching output	
General data	Supply voltage U_B Current consumption Maximum transmission error Temperature coefficient ZERO / SPAN adjustment Step response (10 - 90%) Test voltage, input/output/supply Ambient temperature (operation) Status indication Operating elements
Housing material	Dimensions W / H / D Screw connection solid / stranded / AWG
Conformance / approvals	Conformance / approvals Conformance UL, USA / Canada GL

Technical data	
Frequency input	0.1 Hz ... 120 kHz
NPN/PNP transistor outputs	NAMUR initiators Floating relay contact (dry contact) Frequency generator
Approx. 15 V DC / max. 25 mA (constant)	2 V _{pp} (In case of rectangle 0.1 Hz ... 120 kHz) 2 V _{pp} (In case of sine 8 Hz ... 120 kHz) 13 V _{pp} (In case of sine 1 Hz ... 120 kHz) 30 V (incl. DC voltage)
Any	≥ 1 µs > 12 bit ≤ 32 ms
Isolating amplifier function	0 V ... 10 V (freely adjustable) 0 mA ... 20 mA (freely adjustable)
12 V	24 mA
95 kΩ	200 Ω
14 bit (full-scale)	14 bit (full-scale)
U output	I output
0 ... 5 V / 0 ... 10 V	0 ... 20 mA
12.5 V	25 mA
≥ 500 Ω	≤ 500 Ω
< 20 mV_{pp}	
Transistor output, pnp	Switches supply voltage to terminal block SW, can carry a load of 100 mA, not protected against short-circuit

Description	MCR frequency measuring transducer , for conversion of frequencies into analog signals 0(4)...20 mA, 0...(5)10 V and their inverse signals
--------------------	---

Ordering data		
Type	Order No.	Pcs. / Pkt.
MCR-F-UI-DC1	2814605	1

Connection examples for common frequency transmitters

2-wire DC (mechanical contact)

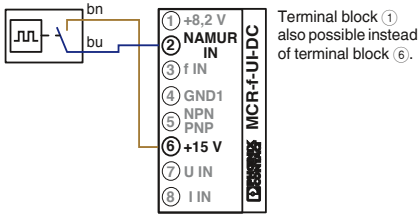

3-wire DC
• With PNP transistor output

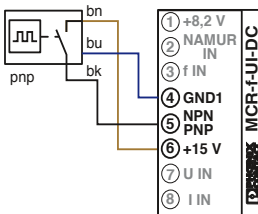

3-wire DC
• PNP transistor with pull-down resistance

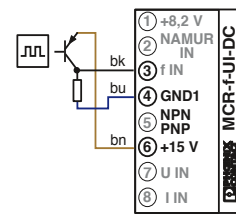

2-wire DC NAMUR sensor

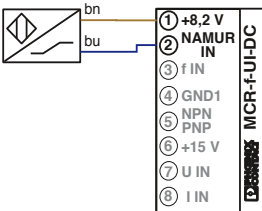

• With NPN transistor output

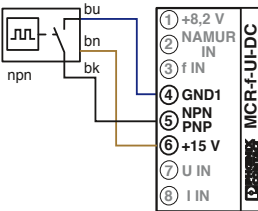

• NPN transistor with pull-up resistance

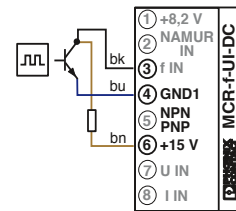

4-wire DC
• With PNP transistor output

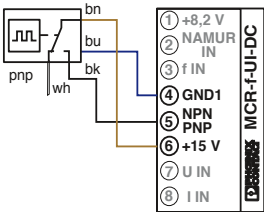

Incremental rotary transducer with push-pull:
• Supply of the external signaling encoder

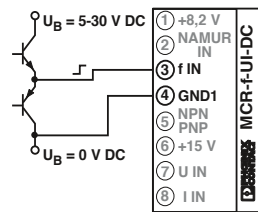

Incremental rotary transducer with HTL logic:
• Supply of the external signaling encoder

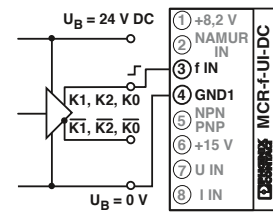

• With NPN transistor output

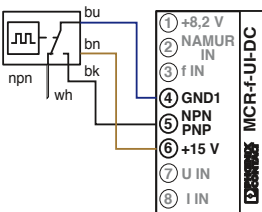

• Supply of the signaling encoder from the module

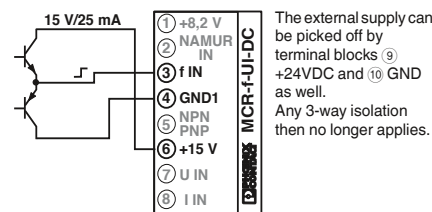

• Supply of the signaling encoder from the module

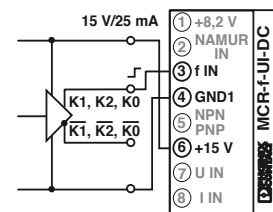

Application examples:

The **MCR-F-UI-DC** frequency transducer converts the pulse signal into an analog standard signal that provides information about the numbers of bottles in filling systems recorded in a defined time unit.

For speed measurements, it is possible to enter the measuring range in revolutions per minute (rpm) and to display the current measured value on the device.

The frequency measuring transducer has an automatic measuring range selection function (autorange) to ensure the best possible resolution. This permits response times to be reduced to a minimum and the measured value is optimally adapted to the input value.

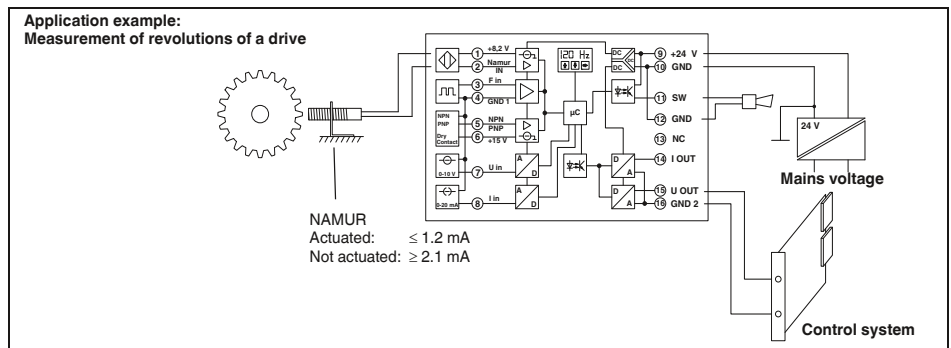
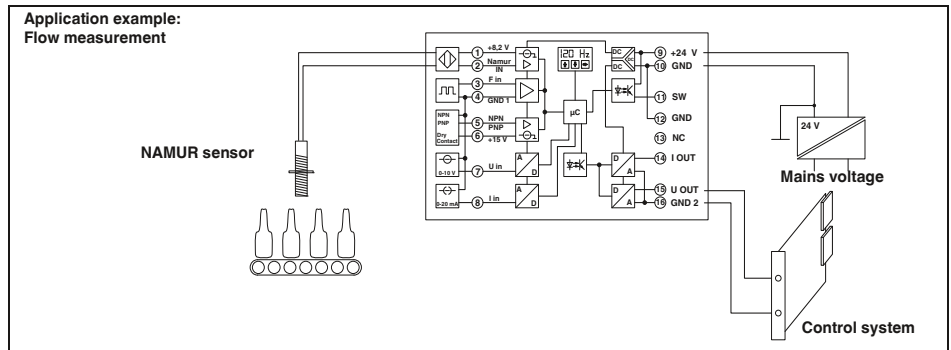

Programmable limit value switch

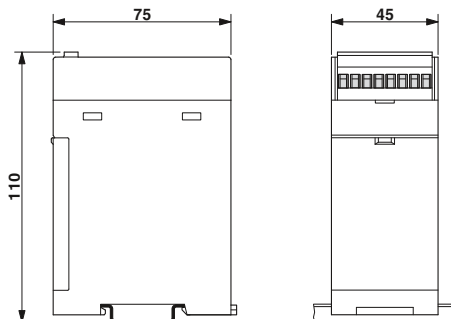
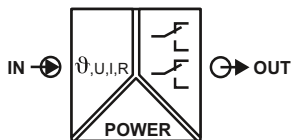

MCR-PSP-DC



- For thermocouple sensors, resistance thermometers, and linear resistors
- For current or voltage signals
- Four independently adjustable switching thresholds
- With or without electrical isolation of input signals
- Programming via membrane keypad or **MCR-PICONF-WIN** software
- Continuous measured value display

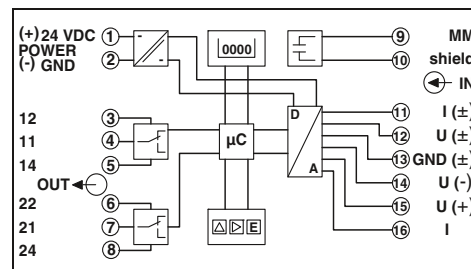

Further information about the configuration software can be found on page 149

1) EMC: Class A product, see page 571

Technical data

Input data

Input sources

Measuring rate

Input resistance

Discontinuous control resolution

Switching output

Contact type

Contact material

Maximum switching voltage

Maximum switching current

Mechanical service life

Response delay

Status indication

General data

Supply voltage U_B

Current consumption

Maximum transmission error

Temperature coefficient

Test voltage input/power supply

Ambient temperature (operation)

Status indication

Mounting

Housing material

Conformance / approvals

Conformance

UL, USA / Canada

Current / voltage

Resistance thermometer 2, 3 or 4-conductor system (according to DIN 43760/DIN IEC 751 or SAMA RC 21-4-1966), e.g., PT sensors, Ni sensors, etc.

Thermocouple sensors (according to DIN IEC 584-1/DIN 43710):

B, E, J, K, L, N, R, S, T, U

Resistance: 0 k Ω ... 8 k Ω (only 2-conductor connection)

Current: - 30 mA...+30 mA

Voltage: - 30 V...+30 V

2 Hz

50 Ω / 200 k Ω

0.1°C / 0.01 V / 0.01 mA / 0.1 Ω

2 x PDT contact, / 2 switching points each, pick-up/drop-out (can be switched)

AgNi 0,15 + HTV (hard gold-plated)

250 V AC

2 A AC

2 x 10⁷ cycles

0 s ... 2 s (adjustable)

LED display

20 V DC ... 30 V DC

< 60 mA

0.1% (of final value)

≤ 0.01%/K

1 kV AC (50 Hz, 1 min.)

-20°C ... 65°C

5-position 7-segment display and LEDs

Any

ABS

CE-compliant

cULus

Description

MCR threshold value switch, with two relay contacts

With electrically isolated input

Type

MCR-PSP-DC¹⁾
MCR-PSP¹⁾

Order No.

2811925
2811912

Pcs. / Pkt.

1
1

Limit values,
threshold value switch

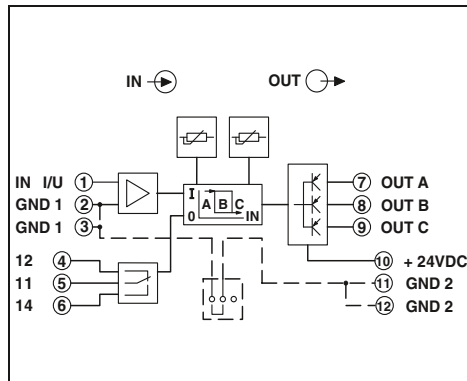
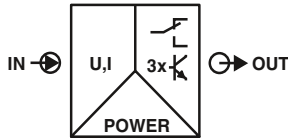

For either standard voltage or
standard current signals

Housing width 17.5 mm

- 0 ... 10 V or 0 ... 20 mA input
- Relay/transistor output
- Limit indicator
- Adjustable hysteresis
- Monitoring of three signal statuses

Notes:

1) EMC: Class A product, see page 571

Input data
Input signal
Maximum input signal
Input resistance
Limit value setting
Setting range of the limit value
Setting range for the hysteresis

Internal hysteresis

Switching output
Number of outputs
Output voltage
Continuous load current
Switching output
Contact type
Contact material
Maximum switching voltage
Maximum switching current
Mechanical service life
Error/status indicator

General data
Supply voltage U_B
Current consumption
Temperature coefficient
Step response (10 - 90%)
Ambient temperature (operation)
Mounting
Housing material
Dimensions W / H / D
Screw connection solid / stranded / AWG
Conformance / approvals
Conformance
UL, USA / Canada

Description
MCR threshold value switch, with adjustable hysteresis and relay/transistor output
Input: 0...0.10 V
Input: 0(4) - 20 mA

Technical data	
MCR-SWS-U ¹⁾	MCR-SWS-I ¹⁾
0 ... 10 V	0 ... 20 mA / 4 ... 20 mA
11 V	22 mA
≥ 100 kΩ	≤ 120 Ω
Setting potentiometer, scaled 270° potentiometer	
0 V ... 10 V	0 A ... 20 mA
0.1 V ... 10 V (setting accuracy: ±30 mV)	0.2 mA ... 20 mA (setting accuracy: ±60 μA)

±30 mV (around the lower/upper switching point) ±60 μA (around the lower/upper switching point)

Transistor output, pnp
3
20 V DC ... 30 V DC
100 mA
Relay output
1 PDT
AgNi 0,15 + HTV (hard gold-plated)
250 V AC (30 V DC)
2 A
10⁷ cycles

20 V DC ... 30 V DC
Typ. 60 mA
≤ 0.02%/K
< 25 ms
-20°C ... 65°C
Any
Polyamide PA non-reinforced
17.5 / 99 / 114.5 mm
0.2 ... 2.5 mm² / 0.2 ... 2.5 mm² / 24 - 14

CE-compliant
UL 508 Recognized

Ordering data		
Type	Order No.	Pcs. / Pkt.
MCR-SWS-U ¹⁾	2766465	1
MCR-SWS-I ¹⁾	2766478	1

Setpoint value potentiometer

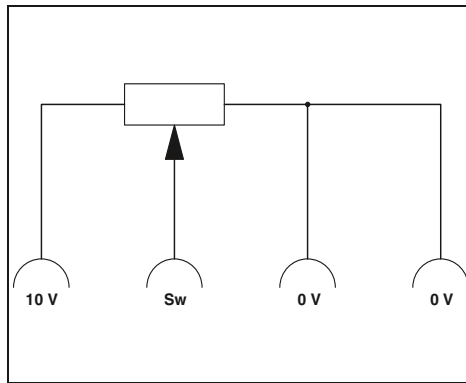
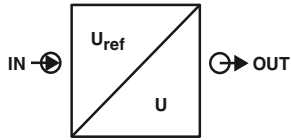

Housing width 30 mm

– For direct setpoint definition in combination with a constant voltage source

Notes:

1) EMC: Class A product, see page 571

Input data
Resistance value
Linearity
Load capacity
General data
Ambient temperature (operation)
Mounting
Housing material
Dimensions W / H / D
Screw connection solid / stranded / AWG

Technical data	
EMG 30-SP- 4K7LIN	EMG 30-SP-10K LIN
4.7 kΩ ±20%	10 kΩ ±20%
5% (of final value)	5% (of final value)
1 W	0.5 W
General data	
0°C ... 40°C	
Any	
Polycarbonate fiber reinforced PC-F	
30 / 75 / 68 mm	
0.2 ... 4 mm ² / 0.2 ... 2.5 mm ² / 24 - 14	

Description
Setpoint potentiometer , to set setpoints individually
Resistance value 4.7 kΩ
Resistance value 10 kΩ

Ordering data		
Type	Order No.	Pcs. / Pkt.
EMG 30-SP- 4K7LIN	2940252	10
EMG 30-SP-10K LIN	2942124	10

MCR constant voltage source
With screw connection
With spring-cage connection

Accessories		
	Order No.	Pcs. / Pkt.
MINI MCR-SL-CVS-24-5-10-NC ¹⁾	2902822	1
MINI MCR-SL-CVS-24-5-10-SP-NC ¹⁾	2902823	1

Accessories

Configuration software package

The **MCR/PI-CONF-WIN configuration software package** is used to configure and visualize all parameters for the programmable MCR measuring transducers.

- Straightforward menu interface
- Rapid programming

Notes:
The software runs under the following operating systems: Windows NT™, 2000™, and XP™.



Description		Ordering data		
<p>MCR configuration software, for programming MCR-T-..., MCR-...-LP-..., MCR-...-HT-..., MCR-S-..., MCR-F-..., and MCR-PSP-... modules, CD-ROM</p>		Type	Order No.	Pcs. / Pkt.
		MCR/PI-CONF-WIN	2814799	1
Labels		Accessories		
<p>Labels, for labeling MCR-T and MCR-S modules, four sheets DIN A4 marking labels (112 pieces.)</p>		Type	Order No.	Pcs. / Pkt.
		MCR-ET 38X35 WH	2814317	1

**USB adapter cable
Software adapter cable**

The following adapter cables are available for programming:

- USB adapter cable
- Interface converter

The following modules are supported:

- MCR-T-UI(-E)...
- MCR-F-UI-DC
- MCR-PSP...
- MCR-FL-T-LP-I
- MCR-SL-PT100-LP-I
- MCR-FL-HT-T-I
- MCR-SL-HT-PT100-I



Data cable

Description		Ordering data		
<p>USB adapter cable, D-9-SUB to USB, with adapter D-9-SUB to D-25-SUB</p>		Type	Order No.	Pcs. / Pkt.
		CM-KBL-RS232/USB	2881078	1
<p>Software adapter cable (stereo jack plug/25-pos. D-SUB), 1.2 m long, for programming MCR-T-..., MCR-S-..., and MCR-F-... modules</p>		Type	Order No.	Pcs. / Pkt.
		MCR-TTL-RS232-E	2814388	1
<p>Software adapter cable (6-pos./D-SUB 25-pos.), 1.5 m length, for programming MCR-PSP modules</p>		Type	Order No.	Pcs. / Pkt.
		MCR-TTL-RS232	2814391	1
<p>Software adapter cable, 2.4 m length, with USB connection, for programming MCR-...-LP-... and MCR-...-HT-... modules</p>		Type	Order No.	Pcs. / Pkt.
		MCR-PAC-T-USB	2309000	1
Adapter cable		Accessories		
<p>Adapter cable, stranded, 9-pos. D-SUB socket on 25-pos. D-SUB pin</p>		Type	Order No.	Pcs. / Pkt.
		PSM-KAD 9 SUB 25/BS	2761295	1

Analog IN standard signals

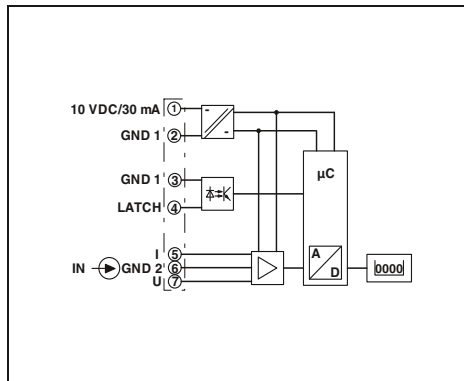
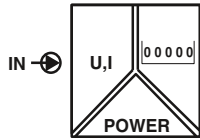

For standard analog signals, programmable

- For 0 ... 10 V and 0(4) ... 20 mA standard analog signals
- Programmable
- 5 positions displayed
- 8 mm LED, 7-segment
- Galvanically isolated
- Min./max. value saving
- Freely programmable decimal point display
- Latch/hold function for storing the display value
- Display 48 x 24 mm

Input data	
Input signal	
Maximum input signal	
Input resistance	
Resolution	
Measuring rate	
Input latch signal	
Switching level	1 signal ("H") 0 signal ("L")
Output data	
Display	
Number of the displayed positions	
Accuracy	
General data	
Supply voltage U_B	
Current consumption	
Data memory	
Resolution A/D	
System hum suppression	
Test voltage input/power supply	
Degree of protection	
Ambient temperature (operation)	
Housing material	
Dimensions W / H / D	
Control panel cutout	
Screw connection solid / stranded / AWG	
Conformance / approvals	
Conformance	
UL, USA / Canada	

Housing width 48 mm

Technical data

U input	I input
0 ... 10 V	0 ... 20 mA / 4 ... 20 mA
30 V DC	50 mA
> 1 MΩ	(approx. 100 Ω with 5 mA / approx. 70 Ω with 20 mA)
1 mV	2 μA
0.5 to 2 measurements/second	
Display stop	
4 V DC ... 30 V DC	
0 V DC ... 2 V DC	
7-segment LED; 8 mm; red	
5	
< 0.1% ±1 digit (At an ambient temperature of 20°C)	
10 V DC ... 30 V DC	
50 mA	
EEPROM 1 mil. memory cycles or 10 years	
14 bit	
Digital filtering 50/60 Hz	
500 V _{rms} (50/60 Hz, 1 min.)	
IP65 from the front	
-10°C ... 50°C	
Macrolon 2405	
48 / 24 / 68 mm	
22(+0.6)x45(+0.8) mm	
0.14 ... 1.5 mm ² / 0.14 ... 1.5 mm ² / 26 - 16	
CE-compliant	
UL 508 Recognized	

Description
MCR digital display , for measurement and display of standard signals
MCR DIN rail adapter for digital displays in a 24 x 48 mm housing

Ordering data		
Type	Order No.	Pcs. / Pkt.
MCR-SL-D-U-I	2864011	1
Accessories		
MCR-SL-D-RA	2810081	1

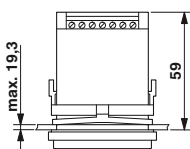
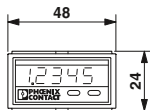

Analog OUT
setpoint adjuster

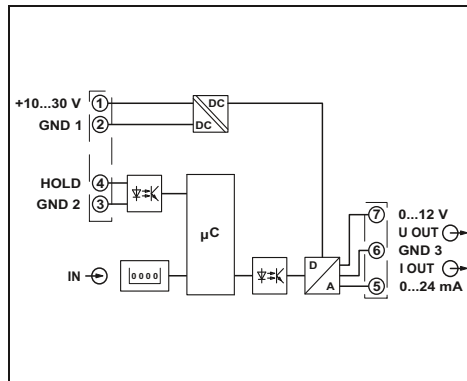
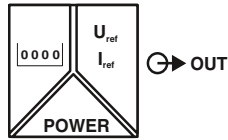

With manual and automatic ramp function

- Manual setpoint definition with step width setting
- Manual setpoint definition via direct input
- Automatic setpoint definition with hold function and 20 support points
- Highly adjustable 0 ... 12 V or 0 ... 24 mA signal ranges
- Data backup in case of a power failure
- Display value parameterization
- Electrical isolation between output and supply

Input data	
Display	7-segment, 8 mm, red
Number of the displayed positions	4
Switching level	1 signal ("H") 0 signal ("L")
Output data	
Output signal	U output 0 ... 12 V
Length of step	10 mV
Load R _B	≥ 2 kΩ
Ripple	≤ 10 mV _{PP}
General data	
Supply voltage U _B	10 V DC ... 30 V DC
Power consumption	1 W (With 24 mA/12 V)
Maximum transmission error	< 0.2% ((full-scale) at rated voltage)
Test voltage output/power supply	500 V AC (50 Hz, 1 min.)
Degree of protection	IP65 from the front
Ambient temperature (operation)	-20°C ... 65°C
Housing material	Macrolon 2405
Dimensions W / H / D	48 / 24 / 68 mm
Control panel cutout	45(+0.6)x22.2(+0.3) mm
Screw connection solid / stranded / AWG	0.14 ... 1.5 mm ² / 0.14 ... 1.5 mm ² / 26 - 16
Conformance / approvals	
Conformance	CE-compliant
UL, USA / Canada	UL 508 Recognized

UL 185
Housing width 48 mm

Technical data		
U output	I output	
0 ... 12 V	0 ... 24 mA	
10 mV	10 µA	
≥ 2 kΩ	≤ 500 Ω (Up to 20 mA) ≤ 400 Ω (> 20 mA)	
≤ 10 mV _{PP}		
10 V DC ... 30 V DC		
1 W (With 24 mA/12 V)		
< 0.2% ((full-scale) at rated voltage)		
500 V AC (50 Hz, 1 min.)		
IP65 from the front		
-20°C ... 65°C		
Macrolon 2405		
48 / 24 / 68 mm		
45(+0.6)x22.2(+0.3) mm		
0.14 ... 1.5 mm ² / 0.14 ... 1.5 mm ² / 26 - 16		
CE-compliant		
UL 508 Recognized		

Description
MCR digital setpoint encoder , for presetting current and voltage signals
MCR DIN rail adapter for digital displays in a 24 x 48 mm housing

Ordering data		
Type	Order No.	Pcs. / Pkt.
MCR-SL-D-SPA-UI	2710314	1
Accessories		
MCR-SL-D-RA	2810081	1

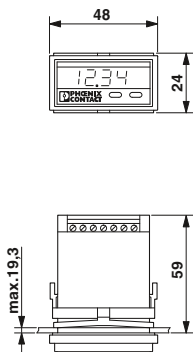



Highly compact – leading technology

MACX Analog Ex – single- and two-channel signal isolating amplifiers for intrinsically safe circuits in the Ex area.

MACX Analog Ex isolating amplifiers ensure maximum system safety and explosion protection within a minimum amount of space. With a design width of just 12.5 mm, this comprehensive range for analog signal conditioning is approved according to ATEX and IECEx and consistently SIL-certified.

Maximum explosion protection for all Ex zones and gas groups

Many process technology systems have areas where potentially explosive atmospheres may occur. As such, measuring and control circuits are usually designed with intrinsic safety protection type Ex i.

MACX Analog Ex i isolating amplifiers and measuring transducers isolate intrinsically safe circuits from non-intrinsically safe circuits and safely limit the energy supplied to the Ex area. Furthermore, they handle extensive signal conditioning tasks.

All MACX Analog Ex isolating amplifiers are approved in accordance with the applicable ATEX and IECEx standards:

- [Ex ia] – for intrinsically safe circuits up to Ex zone 0 and Ex zone 20
- Ex n – for installing devices in Ex zone 2
- In addition, relevant national approvals

such as UL and GOST are available.

Choose the right MACX Analog Ex isolating amplifier for your application:

Analog IN

Measuring transducer repeater power supply and input isolating amplifier for the intrinsically safe operation of 2-wire transmitters, 4-conductor measuring transducers, and current sources.

Analog OUT

Output isolating amplifiers for the intrinsically safe operation of control valves, I/P converters, and displays.

Temperature

Configurable temperature transducers for the intrinsically safe operation of resistance thermometers, remote resistance-type sensors, thermocouples, and mV sources – with safe limit value relays as an option.

Digital IN

NAMUR isolating amplifiers for the intrinsically safe operation of proximity sensors and switches.

Digital OUT

Solenoid drivers for the intrinsically safe operation of solenoid valves and alarm transmitters.



DIN rail connector-compatible

The DIN rail connector enables the modular bridging of the 24 V supply voltage.



Wide-range power supply

The modules featuring a wide-range power supply (...-UP) can be used in all power supply networks the world over without the need for additional power supply units.

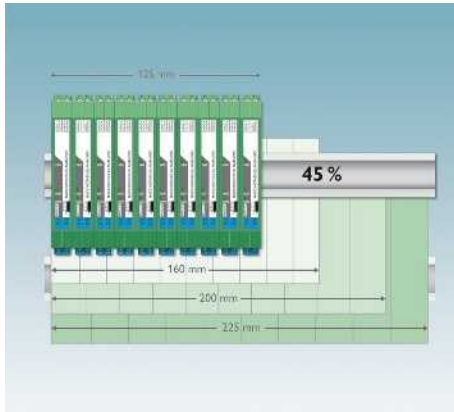

Significant space savings

- Housing width of just 12.5 mm for all single- and two-channel 24 V devices. Saves up to 45% of space, when compared to design widths up to 22.5 mm.



Easy-maintenance connection method:

- Plug-in connection terminal blocks with screw connection or fast push-in technology - coded, with integrated sockets.

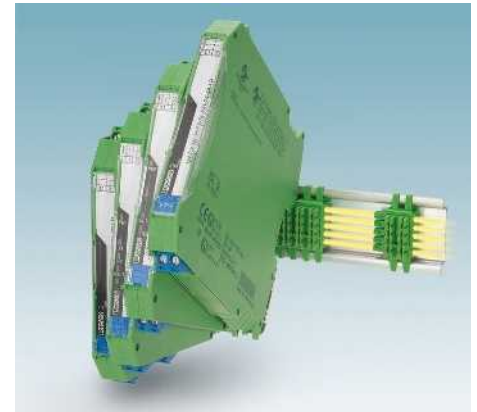

Flexible power bridging and diagnostics

- Supply voltage bridging and the option of redundant, diode-decoupled supply and error indication.



Easy configuration and monitoring

- Either via FDT/DTM or user-friendly stand-alone software - with integrated monitoring function.



Easy configuration

- Without software via DIP switches on the device front or with the operator interface and display unit.

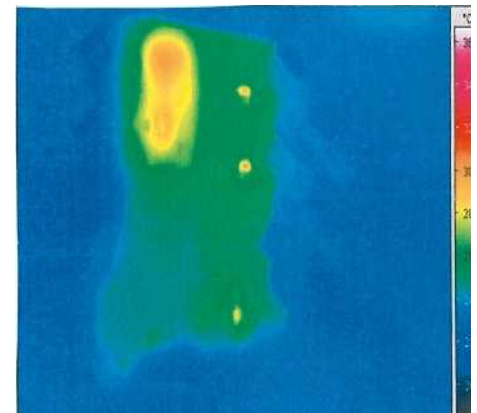

Precise transmission, long service life

- Patented circuit concepts ensure precise transmission and minimal self-heating.



High operational reliability

- High operational reliability, thanks to safe 3-way electrical isolation.



Safe and reliable functions

- Consistent SIL certification. This ensures the highest level of reliability and safety for your systems.



Fast and error-free signal connection

- Compact termination carriers connect MACX Analog Ex devices to the automation system - plug and play.

Facts about explosion protection

The chemical and petrochemical industries involve industrial processes which produce explosive atmospheres. They are caused, for example, by gases, fumes or vapors. Explosive atmospheres are also likely to occur in mills, silos, and sugar and fodder factories due to the dust present there.

Therefore, electrical devices in potentially explosive areas are subject to special directives.

Devices and protective systems in potentially explosive areas

European Parliament directive 94/9/EC of March 23, 1994 (ATEX manufacturer directive) is of particular importance within CENELEC (European Community and Western European EFTA states). It is designed to facilitate the harmonization of legal provisions in the member states of the European Union for devices and protective systems in terms of ensuring correct use in potentially explosive areas. Directive 94/9/EC must be applied to all explosion-protected devices and protective systems placed on the market in the European Union.

The scope of this directive also includes safety, monitoring, and control devices which are used outside of potentially explosive areas, but which are necessary for, or contribute towards, the safe operation of devices and protective systems with respect to explosion hazards.

The term **device** includes machines, equipment, stationary or mobile devices, control components, and system accessories. The directive also covers alarm and protection systems which are meant to be used, either individually or in combination, for the generation, transmission, storage, measurement, control, and conversion of energy as well as for processing materials and which have the potential to ignite and cause an explosion.

Protective systems are devices designed to stop an incipient explosion immediately and/or restrict the area affected by the explosion, and which are placed on the market separately as autonomous systems.



Components are defined as those parts that are necessary for ensuring the safe operation of devices and protective systems, but do not perform an autonomous function in themselves.

European directives are implemented in ordinances or laws at a national level.

Systems in potentially explosive areas

Directive 1999/92/EC (ATEX Operator Directive) was passed in Europe to regulate the operation of systems in potentially explosive areas.

Terminology associated with the Ex area	
Explosive atmosphere	A mixture of combustible gases, steam, vapors or dust and air in atmospheric conditions that allow the entire mixture to combust once ignited.
Potentially explosive area	An area where the atmosphere has the potential to explode due to local or operational conditions ("Ex area").
Electrical equipment	The entire set of components, electric circuits or parts of electric circuits that are usually located within a single housing.
Intrinsically safe electrical equipment	An electrical device in which all circuits are intrinsically safe. Note: these devices may be used directly in the Ex area.
Associated equipment	Electrical devices that contain both intrinsically safe and non-intrinsically safe circuits and that are designed in such a way that the non-intrinsically safe circuits cannot influence the intrinsically safe ones. Note: associated electrical equipment must not be used directly in potentially explosive areas without additional protection defined by a further protection type.

Classification into groups

The general stipulations of EN 60079-0 divide electrical devices for potentially explosive areas into three groups.

Group I:

Electrical devices for firedamp areas (mines) which are susceptible to pit gases (methane) and/or combustible dusts (coal dust).

Group II:

Electrical devices for operation in areas where explosive gas atmospheres are likely

to occur, excluding mines susceptible to firedamp.

This also includes devices for the chemical, petrochemical, and pharmaceutical industries as well as for waste water treatment.

Electrical devices are further divided into subcategories according to the properties of the explosive atmosphere.

In the case of the intrinsic safety protection type, classification is based on the minimum ignition energy of the gas or vapor.

Designation	Typical gas	Ignition energy/[i]J Intrinsic safety
II A	Propane	> 180
II B	Ethylene	60 ... 180
II C	Hydrogen	< 60

Group III:

Electrical devices for operation in areas where explosive dust atmospheres are likely to occur, excluding mines susceptible to firedamp.

This includes devices for areas associated with the food industry (mills, silos), for example.

Electrical devices are further divided into subcategories according to the properties of the explosive atmosphere.

Designation	Dusts
III A	Combustible flyings
III B	Non-conductive dust
III C	Conductive dust

Classification into temperature classes

Simply dividing the various gases into explosion or gas groups according to their minimum ignition energy is not sufficient to describe the gases adequately with regard to their explosive properties.

A gas may explode either when the ignition energy is exceeded or where there is an excessively high temperature caused by a hot surface. This ignition temperature is, however, not usually linked to the ignition energy, i.e., a gas with a low ignition energy does not necessarily explode at a low temperature. Consequently, devices that are used directly in potentially explosive atmospheres are divided into temperature classes. Temperature classes define the maximum surface temperature even in the event of errors. Parallel to this, the gases are classified according to their different ignition temperatures.

Temperature class	Maximum permissible surface temperature of equipment °C	Ignition temperatures of combustible substances °C
T 1	450	> 450
T 2	300	> 300 ≤ 450
T 3	200	> 200 ≤ 300
T 4	135	> 135 ≤ 200
T 5	100	> 100 ≤ 135
T 6	85	> 85 ≤ 100

The following table provides an overview of the ignition energies and ignition temperatures for certain gases:

Substance	T _{ign}	Temperature class	E _{min}	Group
Ethoxyethane	170	T 4	190	II B
Ethylene	425	T 2	82	II B
Ammonia	630	T 1	14000	II A
Butane	365	T 2	250	II A
Methane	595	T 1	280	I
Propane	470	T 1	250	II A
Carbon disulfide	95	T 6	9	II C
Hydrogen	560	T 1	16	II C

Zone classification

Potentially explosive areas are divided into zones according to the probability of their occurrence. The EN 60079-10-1 standard defines the zones containing **explosive atmospheres** as follows:

Zone 0:

Area in which an explosive atmosphere is present for continuous or long periods.

These conditions are usually present inside containers, pipelines, apparatus, and tanks.

Zone 1:

Area in which an explosive atmosphere is to be expected only occasionally during normal operation.

This includes the immediate area surrounding zone 0, as well as areas close to filling and emptying equipment.

Zone 2:

Area in which an explosive atmosphere is not expected during normal operation; however, if it does occur, then it does so only rarely and for a short period.

Zone 2 includes areas that are used exclusively for storage, areas around pipe connections that can be disconnected, and generally the immediate area surrounding zone 1.

Areas that are potentially explosive as a result of **combustible dusts** are divided into the following zones according to EN 60079-10-2 (formerly: EN 61241-10):

Zone 20:

Area in which an explosive atmosphere is present for continuous, frequent or long periods in the form of an airborne cloud of combustible dust.

Zone 21:

Area in which an explosive atmosphere in the form of an airborne cloud of combustible dust is to be expected only occasionally during normal operation.

Zone 22:

Area in which an explosive atmosphere in the form of an airborne cloud of combustible dust is not expected during normal operation. However, if it does occur, then it does so only for a short period.

Categories

The ATEX Directive assigns devices for use in potentially explosive areas to categories. In IEC 60079-0, "Equipment Protection Level (EPL)" is the term used instead of "category".

In the same way that there are different zones, there are also different device categories. These consist of categories M1 and M2 for Group I and categories 1, 2, and 3 for Group II. The categories for **equipment group II** are described in more detail below:

Category 1:

Devices constructed to guarantee a very high degree of safety.

Devices in this category must guarantee the required degree of safety even in the unlikely event of a device failure and therefore be provided with measures to protect against explosion, so that:

- In the event of one integrated protection measure failing, a second, independent protection measure is able to guarantee the necessary safety.
- In the event of two independent errors, the necessary safety is guaranteed.

Category 2:

Devices constructed to guarantee a very high degree of safety.

The explosion protection measures associated with this category guarantee the required degree of safety, even in the case of frequent device failures or common error states.

Category 3:





Devices constructed to guarantee a standard degree of safety.

Devices in this category guarantee an adequate degree of safety in normal operation.

The table below shows which categories are assigned to which zones:

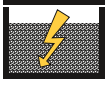
Category	For Zone	Also possible
1	0 20	1 and 2 21 and 22
2	1 21	2 22
3	2 22	

Protection types

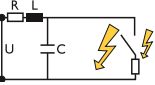
Protection principle	Protection type	Area of application (selection)	Standard
 Isolation	Oil immersion	o Transformers, relays, startup controls, switching devices	EN 60079-6
	Sand filling	q Transformers, relays, capacitors	EN 60079-5
	Molded encapsulation	m* Coils of relays and motors, electronics, solenoid valves, connection systems	EN 60079-18
 Exclusion	Pressurized enclosure	p Control cabinets, motors, measuring and analysis devices, computers	EN 60079-2
 Special mechanical design	Flameproof enclosure	d Motors, switching devices, power electronics	EN 60079-1
 Clearance from electrically conductive parts	Increased safety	e Terminal blocks, housing, lights, motors	EN 60079-7
 Energy limitation	Intrinsic safety	Electronics, measurement and control	EN 60079-11
	Intrinsically safe systems	i* Electronic systems	EN 60079-25
	Intrinsically safe fieldbus systems	Fieldbus systems	EN 60079-27
Improved industrial quality nA: non-sparking nC: sparking equipment nR: restricted breathing housing nL: energy-limited nP: simplified pressurized enclosures	Protection type "n"	n** Motors, housing, lights, electronics	EN 60079-15

* ia, ma: application in zone 0, 1, 2 / ib, mb: application in zone 1, 2 / ic, mc: application in zone 2 only ** Application in zone 2 only

Marking according to ATEX Directive

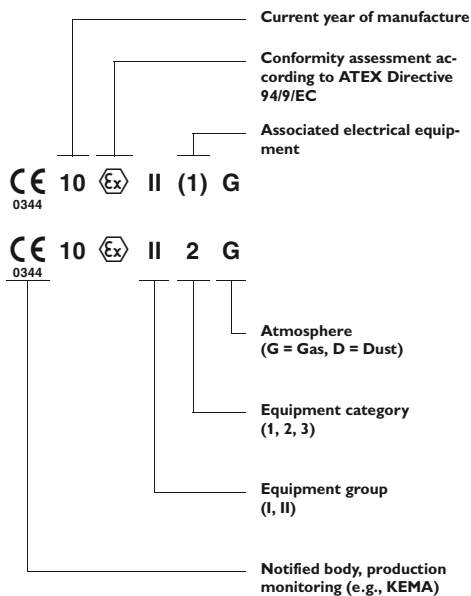

Designation according to EN 60079-0

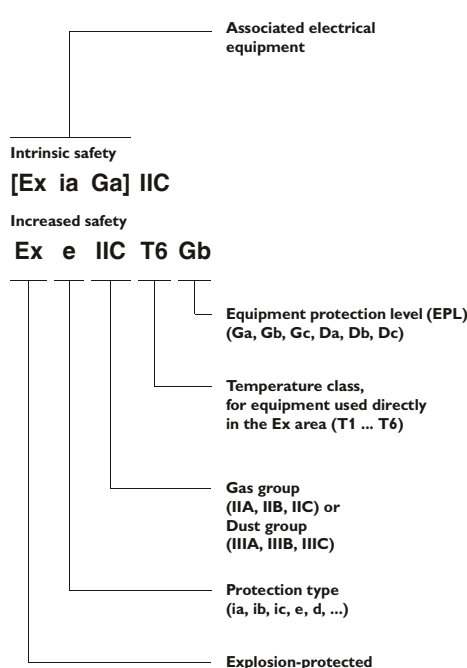

EC-type examination certificate

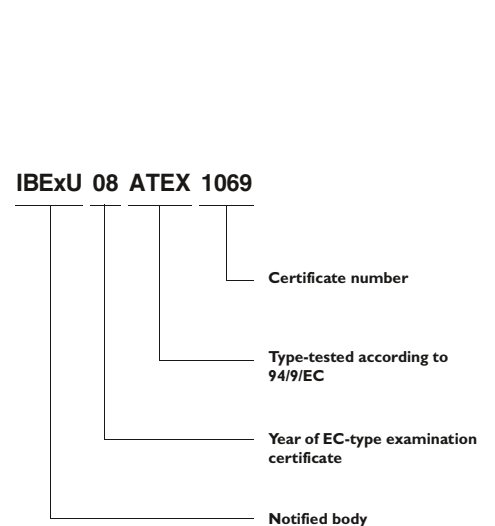

CE mark does not apply to components.

Solenoid drivers for controlling solenoid valves

In order to control intrinsically safe Ex i solenoid valves, you have to have an intrinsically safe control circuit. This is provided by the solenoid drivers that are available from Phoenix Contact.

The following must be taken into account when dimensioning your intrinsically safe control circuit:

- Valve
- Cable with corresponding resistance
- Solenoid driver

As a result, it may be the case that not all valves are compatible with the solenoid drivers.

Below is an extract from a table showing possible combinations of valves and solenoid drivers.

A complete and updated list (along with details of the technical data of suitable valves, the maximum cable lengths, and the maximum cable resistances of the individual combinations) can be found on the Internet at:

www.phoenixcontact.net/products

Example circuit

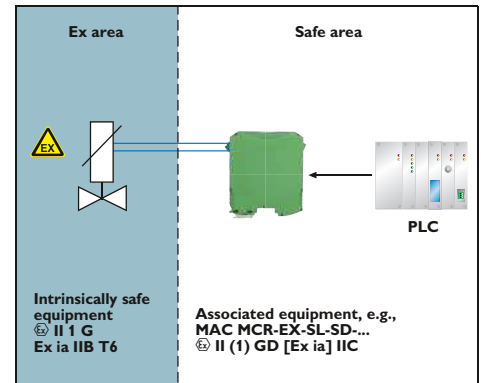

Valves overview

Manufacturer	Type designation	Ex certificate	Condition	INTERFACE Ex solenoid driver			
				MACX MCR-EX-SL-SD-21-25-LP	MACX MCR-EX-SL-SD-21-40-LP	MACX MCR-EX-SL-SD-24-48-LP	MACX MCR-EX-SL-SD-21-60-LP
ASCO	Coil 195	LCIE 08 ATEX 6083			✓	✓	
	Coil 302 (12 V)	INERIS 03 ATEX 0249X					✓
	Coil 302 (24 V)	INERIS 03 ATEX 0249X					✓
Bürkert	Coil AC 10, standard	PTB 01 ATEX 2101			✓	✓	
	Coil AC 10, high-resistance	PTB 01 ATEX 2101			✓	✓	
	Coil AC 21, standard	PTB 01 ATEX 2175	700 mW / 65°C		✓	✓	
	Coil AC 21, high-resistance	PTB 01 ATEX 2175	700 mW / 65°C		✓	✓	
	Coil AC 21, standard	PTB 01 ATEX 2175	900 mW / 45°C		✓	✓	
	Coil AC 21, high-resistance	PTB 01 ATEX 2175	900 mW / 45°C		✓	✓	
	Coil AC 21, standard	PTB 01 ATEX 2175	900 mW / 60°C		✓	✓	
	Coil AC 21, high-resistance	PTB 01 ATEX 2175	900 mW / 60°C		✓	✓	
	Coil G1 642735, standard		600 mW / 50°C		✓		
	Coil G1 642735, high-resistance		600 mW / 50°C		✓		
	Coil G1 642735, standard	PTB 01 ATEX 2173	800 mW / 40°C		✓	✓	
Coil G1 642735, high-resistance	PTB 01 ATEX 2173	800 mW / 40°C		✓	✓		
Coil G1 642735, standard	PTB 01 ATEX 2173	1000 mW / 40°C		✓	✓		
Coil G1 642735, high-resistance	PTB 01 ATEX 2173	1000 mW / 40°C		✓	✓		
FESTO	Coil MFH...IA-SA-EX GBXE022AIAD03	PTB 03 ATEX 2097				✓	✓
	Coil (J)MFH...BIA-SA-EX GBXE022AIAD03	PTB 03 ATEX 2097				✓	✓
Norgren Herion	Coil 2050	PTB 07 ATEX 2019			✓	✓	✓
	Coil 2051	PTB 07 ATEX 2019			✓	✓	✓
	Coil 2052	PTB 07 ATEX 2019			✓	✓	✓
	Coil 2053	PTB 07 ATEX 2019			✓	✓	✓
	Coil 2085	PTB 06 ATEX 2001 U		✓			
	Coil 2086	PTB 06 ATEX 2001 U		✓	✓		✓
	Coil 3039	PTB 03 ATEX 2134				✓	
Hörbiger	Piezo P8 38x RF-Nx-SPN65	DMT 01 ATEX E026X	30 V type	✓	✓		
	Piezo P20 381RF-NG-CPN61	DMT 01 ATEX E025X	30 V type	✓			
Parker	Coil VZ07	LCIE 02 ATEX 6024X			✓	✓	
	Coil VZ33	LCIE 02 ATEX 6024X			✓	✓	
	Coil VZ08	LCIE 02 ATEX 6024X			✓	✓	
	Coil VZ09	LCIE 02 ATEX 6024X			✓	✓	
	Coil VZ95	LCIE 02 ATEX 6024X	EEEx ia IIB T6		✓	✓	✓
	Coil VZ23	LCIE 02 ATEX 6024X			✓	✓	
Samson	Coil 3701-11 (6 V)	PTB 02 ATEX 2178		✓			
	Coil 3701-12 (12 V)	PTB 02 ATEX 2178		✓	✓		
	Coil 3701-13 (24 V)	PTB 02 ATEX 2178		✓		✓	
	Coil 3963-11 (6 V)	PTB 01 ATEX 2085		✓			
	Coil 3963-12 (12 V)	PTB 01 ATEX 2085		✓	✓		
	Coil 3963-13 (24 V)	PTB 01 ATEX 2085		✓		✓	
	Coil 3964-11 (6 V)	PTB 02 ATEX 2047		✓			
	Coil 3964-12 (12 V)	PTB 02 ATEX 2047		✓	✓		
	Coil 3964-13 (24 V)	PTB 02 ATEX 2047		✓		✓	
	Coil 3965-11 (6 V)	PTB 05 ATEX 2044X		✓			
	Coil 3965-12 (12 V)	PTB 05 ATEX 2044X		✓	✓		
	Coil 3965-13 (24 V)	PTB 05 ATEX 2044X		✓		✓	
	Coil 3967-11 (6 V)	PTB 06 ATEX 2027		✓			
	Coil 3967-12 (12 V)	PTB 06 ATEX 2027		✓	✓		
	Coil 3967-13 (24 V)	PTB 06 ATEX 2027		✓		✓	
Seitz	Pilot valve PV 12F73 Ci oH	PTB 99 ATEX 2146		✓	✓	✓	
	Pilot valve PV 12F73 Xi oH	PTB 00 ATEX 2030		✓	✓	✓	
	Pilot valve PV 12F73 Xi oH-2	PTB 00 ATEX 2030		✓	✓	✓	
	Solenoid 11 G 52	PTB 01 ATEX 2020				✓	

Safety-related function for the Ex area

The term SIL (safety integrity level) is becoming more and more significant in the field of process technology. It defines the requirements that a device or a system is expected to fulfill so that the failure probability can be specified. The aim is to achieve maximum possible operational reliability. If a device or system fails, a defined state is attained. Standard-based inspections are carried out to determine statistical probability.

Application of SIL on the basis of EN 61508 and EN 61511

The SIL standard is used for a wide range of industries within the process industry, including the chemical industry, refineries, oil and gas production, paper manufacturing, and conventional power generation. In addition to functional safety requirements, systems in potentially explosive areas are also subject to Ex standards EN 60079-0 ff.

EN 61508: “Functional safety of electrical/electronic/programmable electronic safety-related systems”

This standard describes the requirements that the manufacturer has to bear in mind when producing devices or systems.

EN 61511: “Functional safety - Safety instrumented systems for the process industry sector”

Standard EN 61511 describes the requirements for achieving systems with functional safety.

Compliance with the standard is determined by operators, owners, and planners on the basis of safety plans and national regulations. In addition, the standard also describes the requirements for using a device in an application on the basis of its proven effectiveness (proven in use).



SIL marking on devices

The products in the MACX range from Phoenix Contact, which have been developed in accordance with EN 61508, are marked with the designation SIL 2 or SIL 3. This indicates clearly that the devices may be suitable for safety instrumented functions (SIF).

To determine whether they can actually

be used, you need to calculate the sum of the probability failure values for all the devices in the signal circuit. The values required for this can be found in the safety manual accompanying any SIL product.

Overview of terms from SIL standards EN 61508 and EN 61511

SIL	Safety integrity level One of four discrete levels for the specification of requirements for the safety integrity of safety instrumented functions, which are assigned to the E/E/PE safety instrumented systems, where SIL 4 is the highest and SIL 1 the lowest level.	E/E/PES	Electrical/electronic/programmable electronic systems This term is used for all electrical devices or systems which can be used to execute a safety instrumented function. It includes simple electrical devices and all types of programmable logic controllers (PLCs).
EUC	Equipment under control Equipment, machines, devices or systems used in production, materials processing or transport.	PFH	Probability of dangerous failure per hour Describes the probability of a dangerous failure occurring per hour.
MTBF	Mean Time Between Failures The expected mean time between failures.	SFF	Safe failure fraction Describes the proportion of harmless failures. This is the ratio of the rate of safe failures plus the rate of diagnosed or detected faults in relation to the total failure rate of the system.
PFD	Probability of failure on demand The probability of a failure on demand. Describes the probability of a safety instrumented system failing to perform its function when required.	SIF	Safety instrumented function Describes the safety instrumented functions of a system.
PFDavg	Average probability of failure on demand The average probability of the function failing on demand.	SIS	Safety instrumented system An SIS (safety instrumented system) consists of one or more safety instrumented functions. An SIL requirement is applicable for each of these safety instrumented functions.

Ex i isolating amplifiers with SIL functional safety - MACX Analog Ex

SIL inspection

The complete signal path must be taken into account during the SIL inspection. The example shows how in a typical safety application the calculation is based on average failure probabilities of individual devices.

Table 2 of standard EN 61508-1 describes the relationship between the average failure probability and the attainable SIL. Here, the level required determines the overall budget for the sum of all PFD values.

A system with a single-channel structure with a low demand rate is used as an example; for SIL 2 the average PFD value is between 10^{-3} and $< 10^{-2}$.

The INTERFACE Analog and INTERFACE Ex product ranges include products that meet the requirements for explosion protection as well as functional safety.

Safety integrity level SIL	Operating mode with a low demand rate (average probability of the specified function failing on demand)
4	$\geq 10^{-5}$ to $< 10^{-4}$
3	$\geq 10^{-4}$ to $< 10^{-3}$
2	$\geq 10^{-3}$ to $< 10^{-2}$
1	$\geq 10^{-2}$ to $< 10^{-1}$

Safety integrity level: failure limit values for a safety function which is operated in an operating mode with a low demand rate.

Example:

A sensor and actuator are assembled in the field and are exposed to chemical and physical loads (process medium, pressure, temperature, vibration, etc.). Accordingly, these components have a high risk of failure:

- The sensor accounts for 25% of the overall PFD
- The actuator accounts for 40% of the overall PFD

Neither the failsafe controller nor the interface modules come into contact with the process medium and both are usually located in a protected control cabinet:

- The failsafe controller accounts for 15% of the overall PFD
- Each of the interface modules accounts for 10% of the overall PFD

Typically, the values form the basis for a calculation.

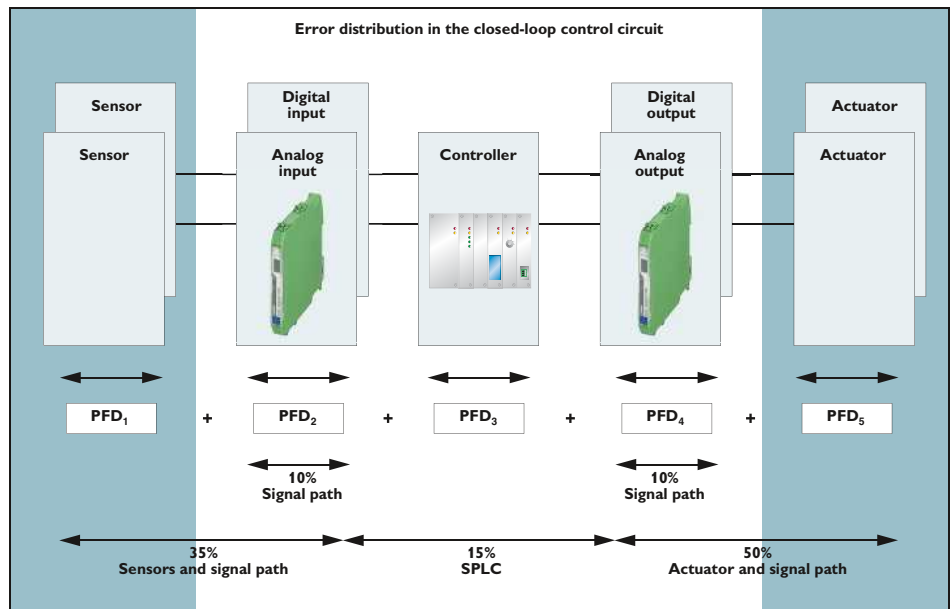

Analog IN

Repeater power supply, Ex i

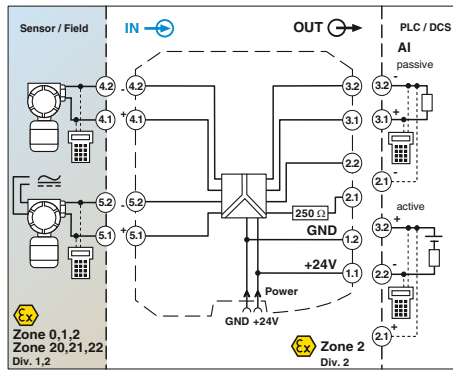
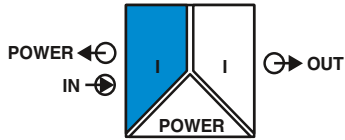

Repeater power supply and input isolating amplifier

UL Functional safety
 Ex: Ex i, Ex ii, Ex iii // Applied for: GL
 Housing width 12.5 mm

Repeater power supply and input isolating amplifier for the operation of intrinsically safe (Ex-i) 2-conductor measuring transducers, 4-conductor measuring transducers, and mA current sources installed in Ex areas.

- 0/4 ... 20 mA input, [Ex ia] (powered or not powered)
- 0/4...20 mA output (active or passive)
- Bidirectional transmission of digital HART communication signals
- Plug-in capable screw or spring-cage connection method, with integrated sockets for HART communicators
- Terminal point with 250 Ω resistor to increase the HART impedance in the case of low-impedance systems
- 3-way electrical isolation
- Power supply via DIN rail connector possible
- Up to SIL 2 according to EN 61508
- Installation in zone 2 permitted

Notes:
Information about the supply and error evaluation module as well as about the DIN rail connectors and marking material can be found from page 182
Test plugs for test sockets can be found on page 191
Information on "Plug and play" connection using system cabling can be found from page 184
1) EMC: Class A product, see page 571

Input data
Input signal
Transmitter supply voltage
Voltage drop
Output data
Output signal
Load
Output ripple
General data
Supply voltage range
Current consumption
Power dissipation
Temperature coefficient
Step response (10 - 90%)
Transmission error, typical
Maximum transmission error
Under-/overload range
Electrical isolation
Ambient temperature range
Humidity
Status indication
SMART communication
Signal bandwidth
Protocols supported
Housing material
Inflammability class according to UL 94
Dimensions W / H / D
Screw connection solid / stranded / AWG
Spring-cage connection (solid/stranded/AWG)
Safety data as per ATEX
Maximum voltage U _o
Maximum current I _o
Maximum power P _o
Maximum voltage U _m
Conformance / approvals
Conformance
ATEX
IECEX
UL, USA / Canada
Functional safety (SIL)

Technical data

0 mA ... 20 mA / 4 mA ... 20 mA
> 16 V (at 20 mA)
< 3.5 V (in input isolating amplifier operation)
0 mA ... 20 mA (active)
4 mA ... 20 mA (active)
0 mA ... 20 mA (14 ... 26 V ext. source voltage)
4 mA ... 20 mA (14 ... 26 V ext. source voltage)
< 600 Ω
< 20 mV _{rms}
19.2 V DC ... 30 V DC
< 60 mA (at 24 V DC)
< 1.1 W (at 24 V DC / 20 mA)
< 0.01%/K
< 600 μs (for 4 mA ... 20 mA step)
< 0.05% (of final value)
< 0.1% (of final value)
as per NE 43
2.5 kV (50 Hz, 1 min., test voltage)
300 V _{rms} (Rated insulation voltage, surge voltage category II; pollution degree 2, safe isolation as per EN 61010, EN 50178)
375 V (Peak value in accordance with EN 60079-11)
375 V (Peak value in accordance with EN 60079-11)
-20°C ... 60°C (Any mounting position)
10% ... 95% (no condensation)
Green LED (supply voltage)
Yes
as per HART specifications
HART
PA 66-FR
V0
12.5 / 99 / 114.5 mm
0.2 ... 2.5 mm ² / 0.2 ... 2.5 mm ² / 24 - 14
0.2 ... 1.5 mm ² / 0.2 ... 1.5 mm ² / 24 - 16
25.2 V
93 mA
587 mW
253 V AC (125 V DC)
CE-compliant, additionally EN 61326
Ex II (1) G [Ex ia Ga] IIC/IIB
Ex II (1) D [Ex ia Da] IIIC
Ex II 3(1) G Ex nA [ia Ga] IIC/IIB T4 Gc
[Ex ia Ga] IIC/IIB; [Ex ia Da] IIIC; Ex nA [ia Ga] IIC/IIB T4 Gc
Class I Div 2; IS for Class I, II, III Div 1
SIL 2 according to EN 61508

Ordering data

Description	Type	Order No.	Pcs. / Pkt.
Repeater power supply, smart, intrinsically safe input			
Screw connection	MACX MCR-EX-SL-RPSSI-I ¹)	2865340	1
Spring-cage conn.	MACX MCR-EX-SL-RPSSI-I-SP ¹)	2924016	1

Analog IN

Repeater power supply, Ex i

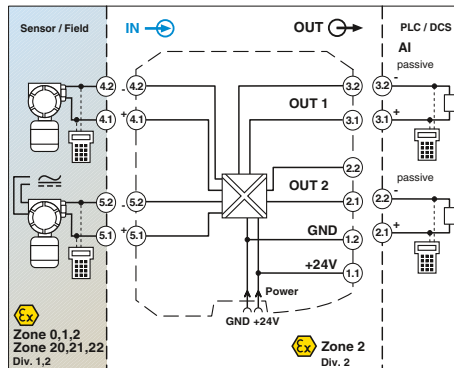
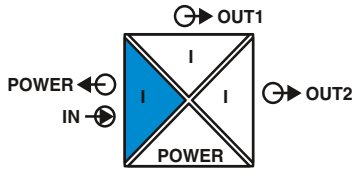

Repeater power supply and input isolating amplifier, with two electrically isolated outputs

Functional safety
Ex:
Housing width 12.5 mm

Repeater power supply and input isolating amplifier for the operation of intrinsically safe (Ex-i) 2-conductor measuring transducers, 4-conductor measuring transducers, and mA current sources installed in Ex areas.

- 0/4 ... 20 mA input, [Ex ia] (powered or not powered)
- Two electrically isolated 0/4 ... 20 mA (active) outputs
- Bidirectional transmission of digital HART communication signals (both outputs)
- Plug-in capable screw or spring-cage connection method, with integrated sockets for HART communicators
- 4-way electrical isolation
- Power supply via DIN rail connector possible
- Up to SIL 2 according to EN 61508
- Installation in zone 2 permitted

Notes:
Information about the supply and error evaluation module as well as about the DIN rail connectors and marking material can be found from page 182
Test plugs for test sockets can be found on page 191
Information on "Plug and play" connection using system cabling can be found from page 184
1) EMC: Class A product, see page 571

Input data	
Input signal	
Transmitter supply voltage	
Voltage drop	
Output data	
Output signal (Per output)	
Load	
Output ripple	
General data	
Supply voltage range	
Current consumption	
Power dissipation	
Temperature coefficient	
Step response (10 - 90%)	
Transmission error, typical	
Maximum transmission error	
Under-/overload range	
Electrical isolation	

Input/output/power supply

Input/output
Input/power supply
Output 1/output 2

Ambient temperature range	
Status indication	
SMART communication (Per output)	
Protocols supported	
Housing material	
Dimensions W / H / D	
Screw connection solid / stranded / AWG	
Spring-cage connection (solid/stranded/AWG)	

Safety data as per ATEX	
Maximum voltage U_o	
Maximum current I_o	
Maximum power P_o	
Maximum voltage U_m	

Conformance / approvals	
Conformance	
ATEX	

IECEX	
Functional safety (SIL)	

Technical data

4 mA ... 20 mA / 0 mA ... 20 mA
> 16 V (at 20 mA)
< 3.9 V (in input isolating amplifier operation)

4 mA ... 20 mA (active)
< 450 Ω (at 20 mA)
< 20 mV_{rms}

19.2 V DC ... 30 V DC (24 V DC (-20% ... +25%))
< 75 mA (24 V DC/ 20 mA)
< 1.45 W (24 V DC/ 20 mA)
< 0.01%/K
< 1.3 ms (for 4 mA ... 20 mA step)
< 0.05% (of final value)
< 0.1% (of final value)
as per NE 43

2.5 kV (50 Hz, 1 min., test voltage)
300 V_{rms} (Rated insulation voltage, surge voltage category II; pollution degree 2, safe isolation as per EN 61010, EN 50178)

375 V (Peak value in accordance with EN 60079-11)
375 V (Peak value in accordance with EN 60079-11)
1.5 kV AC (50 Hz, 1 min., test voltage)
-20°C ... 60°C (Any mounting position)
Green LED (PWR supply voltage)
Yes
HART
PA 66-FR
12.5 / 99 / 114.5 mm
0.2 ... 2.5 mm² / 0.2 ... 2.5 mm² / 24 - 14
0.2 ... 1.5 mm² / 0.2 ... 1.5 mm² / 24 - 16

25.2 V
93 mA
587 mW
253 V AC (125 V DC)

CE-compliant, additionally EN 61326
 II (1) G [Ex ia Ga] IIC/IIB
 II (1) D [Ex ia Da] IIIC
 II 3(1) G Ex nA [ia Ga] IIC/IIB T4 Gc
[Ex ia Ga] IIC/IIB; [Ex ia Da] IIIC; Ex nA [ia Ga] IIC/IIB T4 Gc
SIL 2 according to EN 61508

Ordering data

Description	Type	Order No.	Pcs. / Pkt.
Repeater power supply, smart, intrinsically safe input			
Screw connection	MACX MCR-EX-SL-RPSSI-2I ¹)	2865366	1
Spring-cage conn.	MACX MCR-EX-SL-RPSSI-2I-SP ¹)	2924236	1

Analog IN
Repeater power supply, Ex i

N

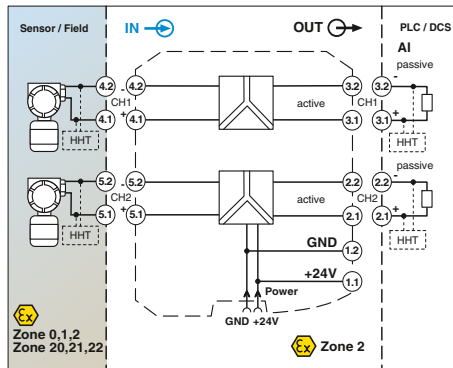

2-channel repeater power supply

Repeater power supply for the operation of intrinsically safe (Ex i) 2-conductor measuring transducers installed in the Ex area.

- 2-channel
- 4 ... 20 mA input, [Ex ia] (powered)
- 4 ... 20 mA output (active)
- Bidirectional transmission of digital HART communication signals
- Plug-in capable screw or spring-cage connection method, with integrated sockets for HART communicators
- Safe 3-way electrical isolation
- Power supply via DIN rail connector possible
- Up to SIL 2 according to EN 61508
- Installation in zone 2 permitted

Notes:
Information on the supply and error evaluation module, DIN rail connectors, system cabling, and marking material can be found from page 182
Test plugs for test sockets can be found on page 191
Information on "Plug and play" connection using system cabling can be found from page 184

Input data	
Input signal	
Transmitter supply voltage	
Underload/overload signal range	
Output data	
Output signal	
Load	
Underload/overload signal range	
General data	
Supply voltage range	
Current consumption	
Power dissipation	
Temperature coefficient	
Step response (10 - 90%)	
Transmission error, typical	
Maximum transmission error	
Electrical isolation	
Safety data as per ATEX	
Maximum voltage U_o	
Maximum current I_o	
Maximum power P_o	
Maximum voltage U_m	
Conformance / approvals	
Conformance	
ATEX	
IECEX	
Functional safety (SIL)	

Housing width 12.5 mm

Technical data

Per channel	
4 mA ... 20 mA	
> 16 V (at 20 mA)	
0 mA ... 24 mA	
Per channel	
4 mA ... 20 mA (active)	
450 Ω (at 20 mA)	
0 mA ... 24 mA	
General data	
19.2 V DC ... 30 V DC (24 V DC (-20% ... +25%))	
< 100 mW (24 V / 20 mA)	
< 1.4 W (at 24 V DC / 20 mA)	
< 0.01%/K	
< 1.3 ms (for 4 mA ... 20 mA step)	
< 0.05% (of final value)	
< 0.1% (of final value)	
Input/output/power supply	
2.5 kV (50 Hz, 1 min., test voltage)	
300 V _{rms} (Rated insulation voltage, surge voltage category II; pollution degree 2, safe isolation as per EN 61010, EN 50178)	
Input/output	375 V (Peak value in accordance with EN 60079-11)
Input/power supply	375 V (Peak value in accordance with EN 60079-11)
Output 1/output 2	1.5 kV (50 Hz, 1 min., test voltage)
	-20°C ... 60°C (Any mounting position)
	Green LED (supply voltage)
	Yes
	as per HART specifications
	HART
	PA 66-FR
	12.5 / 99 / 114.5 mm
	0.2 ... 2.5 mm ² / 0.2 ... 2.5 mm ² / 24 - 14
	0.2 ... 1.5 mm ² / 0.2 ... 1.5 mm ² / 24 - 16
Safety data as per ATEX	
Maximum voltage U_o	25.2 V
Maximum current I_o	93 mA
Maximum power P_o	587 mW
Maximum voltage U_m	253 V AC (125 V DC)
Conformance / approvals	
Conformance	CE-compliant, additionally EN 61326
ATEX	[Ex] II (1) G [Ex ia Ga] IIC
	[Ex] II (1) D [Ex ia Da] IIIC
	[Ex] II 3(1) G Ex nA [ia Ga] IIC T4 Gc
	[Ex ia Ga] IIC/IIB; [Ex ia Da] IIIC; Ex nA IIC T4 Gc
	SIL 2, PL d

Ordering data

Description	Type	Order No.	Pcs. / Pkt.
Repeater power supply, 2-channel, smart, intrinsically safe input			
	Screw connection	MACX MCR-EX-SL-RPSS-2I-2I	2865382
	Spring-cage conn.	MACX MCR-EX-SL-RPSS-2I-2I-SP	2924676

Analog IN

Repeater power supply with wide range power supply, Ex i

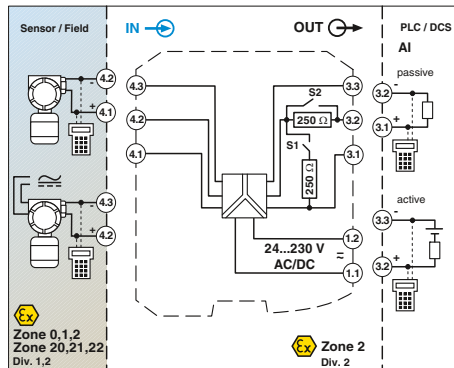
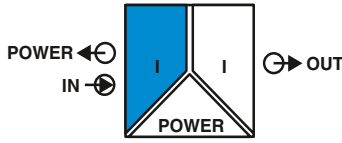

Repeater power supply and input isolating amplifier, wide-range power supply

Functional safety
 Ex: Ex i Ex ii Ex iii // Applied for: GL
 Housing width 17.5 mm

Repeater power supply and input isolating amplifier for the operation of intrinsically safe (Ex-i) 2-conductor measuring transducers, 4-conductor measuring transducers, and mA current sources installed in Ex areas.

- 0/4 ... 20 mA input, [Ex ia] (powered or not powered)
- Output 0/4...20 mA (active or passive), 0/1...5 V, can be switched via the DIP switch
- Bidirectional transmission of digital HART communication signals
- Plug-in capable screw or spring-cage connection method, with integrated sockets for HART communicators
- 250 Ω resistor that can be activated via DIP switches to increase the HART impedance in the case of low-impedance systems
- 3-way electrical isolation
- Wide-range power supply: 19.2 ... 253 V AC/DC
- Up to SIL 2 according to EN 61508
- Installation in zone 2 permitted

Input data	
Input signal	
Transmitter supply voltage	
Voltage drop	
Output data	
Output signal (configurable using the DIP switch)	
Load	
Output ripple	
General data	
Supply voltage range	
Current consumption	
Power dissipation	
Temperature coefficient	
Step response (10 - 90%)	
Transmission error, typical	
Maximum transmission error	
Under-/overload range	
Electrical isolation	
Ambient temperature range	
Humidity	
Status indication	
SMART communication	
Signal bandwidth	
Protocols supported	
Housing material	
Inflammability class according to UL 94	
Dimensions W / H / D	
Screw connection solid / stranded / AWG	
Spring-cage connection (solid/stranded/AWG)	
Safety data as per ATEX	
Maximum voltage U_o	25.2 V
Maximum current I_o	93 mA
Maximum power P_o	587 mW
Maximum voltage U_m	253 V AC (125 V DC)
Conformance / approvals	
Conformance	
ATEX	
IECEX	
UL, USA / Canada	
Functional safety (SIL)	

Technical data

0 mA ... 20 mA / 4 mA ... 20 mA
> 16 V (at 20 mA)
< 3.5 V (in input isolating amplifier operation)
0 mA ... 20 mA (active)
4 mA ... 20 mA (active)
0 mA ... 20 mA (14 ... 26 V ext. source voltage)
4 mA ... 20 mA (14 ... 26 V ext. source voltage)
0 V ... 5 V (internal resistance, 250 Ω, 0.1%)
1 V ... 5 V (internal resistance, 250 Ω, 0.1%)
< 600 Ω (I output)
< 20 mV _{rms}
24 V ... 230 V AC/DC (-20%/+10%, 50/60 Hz)
< 80 mA (at 24 V DC)
< 1.6 W
< 0.01%/K
< 600 μs (for 4 mA ... 20 mA step)
< 0.05% (of final value)
< 0.1% (of final value)
as per NE 43
2.5 kV (50 Hz, 1 min., test voltage)
300 V _{rms} (Rated insulation voltage, surge voltage category II; pollution degree 2, safe isolation as per EN 61010, EN 50178)
375 V (Peak value in accordance with EN 60079-11)
375 V (Peak value in accordance with EN 60079-11)
-20°C ... 60°C (Any mounting position)
10% ... 95% (no condensation)
Green LED (supply voltage)
Yes
as per HART specifications
HART
PA 66-FR
V0
17.5 / 99 / 114.5 mm
0.2 ... 2.5 mm ² / 0.2 ... 2.5 mm ² / 24 - 14
0.2 ... 1.5 mm ² / 0.2 ... 1.5 mm ² / 24 - 16
25.2 V
93 mA
587 mW
253 V AC (125 V DC)
CE-compliant, additionally EN 61326
Ex II (1) G [Ex ia Ga] IIC/IIB
Ex II (1) D [Ex ia Da] IIIC
Ex II 3(1) G Ex nA [ia Ga] IIC/IIB T4 Gc
[Ex ia Ga] IIC/IIB; [Ex ia Da] IIIC; Ex nA [ia Ga] IIC/IIB T4 Gc
Class I Div 2; IS for Class I, II, III Div 1
SIL 2 according to EN 61508

Notes:
Information on marking material can be found on page 127
Test plugs for test sockets can be found on page 191
1) EMC: Class A product, see page 571

Ordering data

Description	Type	Order No.	Pcs. / Pkt.
Repeater power supply, smart, intrinsically safe input			
Screw connection	MACX MCR-EX-SL-RPSSI-I-UP ¹⁾	2865793	1
Spring-cage conn.	MACX MCR-EX-SL-RPSSI-I-UP ¹⁾	2924029	1

Analog OUT
Output isolating amplifier, Ex-i

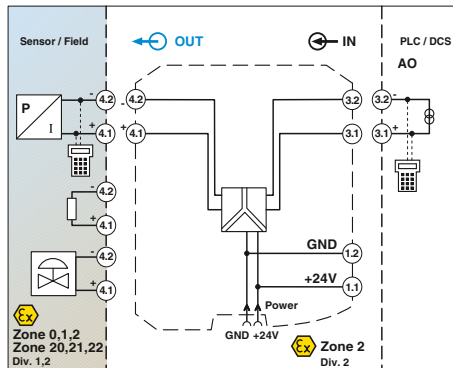
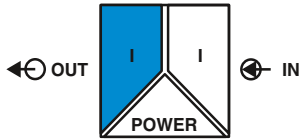

Functional safety
Ex: Ex, Ex, Ex, Ex
Housing width 12.5 mm

Output isolating amplifier for controlling intrinsically safe (Ex-i) I/P converters, control valves, and indicators installed in Ex areas.

- 0/4...20 mA input
- 0/4...20 mA output, [Ex ia] IIC
- Bidirectional transmission of digital HART communication signals
- Plug-in capable screw or spring-cage connection method, with integrated sockets for HART communicators
- Line fault detection (LF)
- 3-way electrical isolation
- Power supply via DIN rail connector possible
- Up to SIL 2 according to EN 61508
- Installation in zone 2 permitted

Notes:

Information about the supply and error evaluation module as well as about the DIN rail connectors and marking material can be found from page 182

Test plugs for test sockets can be found on page 191

Information on "Plug and play" connection using system cabling can be found from page 184

Input data	Input signal Input voltage Input impedance in the event of a cable break at the output
Output data	Output signal Load Output ripple
General data	Supply voltage range Current consumption Power dissipation Temperature coefficient Step response (10 - 90%) Maximum transmission error Electrical isolation
Ambient temperature range	Humidity Status indication SMART communication Signal bandwidth Protocols supported Housing material Inflammability class according to UL 94 Dimensions W / H / D Screw connection solid / stranded / AWG Spring-cage connection (solid/stranded/AWG)
Safety data as per ATEX	Maximum voltage U_o Maximum current I_o Maximum power P_o Maximum voltage U_m
Conformance / approvals	Conformance ATEX IECEX UL, USA / Canada Functional safety (SIL)

Technical data

Input data	0 mA ... 20 mA / 4 mA ... 20 mA 5.4 V (at 20 mA) > 100 kΩ (if there is a line fault)
Output data	0 mA ... 20 mA / 4 mA ... 20 mA < 800 Ω (at 20 mA) < 20 mV _{rms}
General data	19.2 V DC ... 30 V DC < 46 mW (at 24 V DC / 20 mA) < 1.1 W (at 24 V DC / 20 mA) < 0.01%/K < 140 μs < 0.1% (of final value)
Input/output/power supply	1.5 kV (50 Hz, 1 min., test voltage) 300 V _{rms} (Rated insulation voltage, surge voltage category II; pollution degree 2, safe isolation as per EN 61010, EN 50178)
Output/input	375 V (Peak value in accordance with EN 60079-11)
Output/power supply	375 V (Peak value in accordance with EN 60079-11) -20°C ... 60°C (Any mounting position) 10% ... 95% (no condensation) Green LED (supply voltage) Yes as per HART specifications HART PA 66-FR V0 12.5 / 99 / 114.5 mm 0.2 ... 2.5 mm ² / 0.2 ... 2.5 mm ² / 24 - 14 0.2 ... 1.5 mm ² / 0.2 ... 1.5 mm ² / 24 - 16
Safety data as per ATEX	27.7 V 92 mA 633 mW 253 V AC (125 V DC)
Conformance / approvals	CE-compliant, additionally EN 61326 Ex II (1) G [Ex ia Ga] IIC Ex II (1) D [Ex ia Da] IIC Ex II 3(1) G Ex nA [ia Ga] IIC T4 Gc [Ex ia Ga] IIC; [Ex ia Da] IIC; Ex nA [ia Ga] IIC T4 Gc Class I Div 2; IS for Class I, II, III Div 1 SIL 2 according to EN 61508

Ordering data

Description	Output isolating amplifier, smart, output intrinsically safe
	Screw connection Spring-cage conn.

Type	Order No.	Pcs. / Pkt.
MACX MCR-EX-SL-IDSI-I	2865405	1
MACX MCR-EX-SL-IDSI-I-SP	2924032	1

Temperature transducer, Ex i

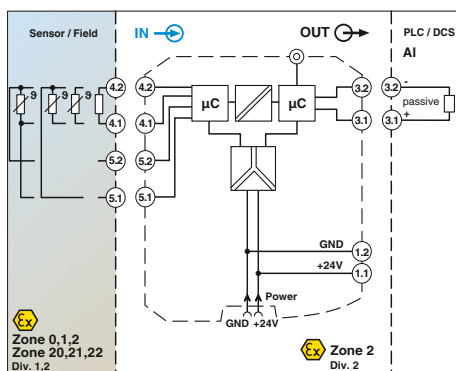
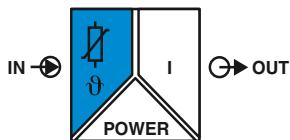

For resistance thermometers and resistance-type sensors

Ex i, SIL
 Ex: Ex i, Ex ii, Ex iii
 Housing width 12.5 mm

Programmable temperature transducer for intrinsically safe operation of resistance thermometers and resistance-type sensors installed in Ex areas. The measured values are converted into a linear 0 ... 20 mA or 4 ... 20 mA signal.

- Input for resistance thermometers and resistance-type sensors, [Ex ia]
- 0 ... 20 mA or 4 ... 20 mA output
- Configuration via software (FDT/DTM): Sensor type, connection method, measuring range, measuring unit, filter, alarm signal, and output range
- Programming during operation with Ex measuring circuit connected and also voltage-free using IFS-USB-PROG-ADAPTER programming adapter
- Status indicator for supply voltage, cable, sensor, and module errors
- 3-way electrical isolation
- Power supply via DIN rail connector possible
- Up to SIL 2 according to EN 61508
- Installation in zone 2 permitted

Input data	Resistance thermometers Resistor Cable resistance Sensor input current Measuring range span
Output data	Output signal Load Behavior in the event of a sensor error Output ripple
General data	Supply voltage range Current consumption Power dissipation Temperature coefficient Step response (0 - 99%)
	Transmission error, total ZERO / SPAN adjustment Electrical isolation
	Input/output/power supply
	Input/output Input/power supply
	Ambient temperature range Humidity Status indication
	Housing material Inflammability class according to UL 94 Dimensions W / H / D Screw connection solid / stranded / AWG Spring-cage connection (solid/stranded/AWG)
	Safety data as per ATEX Maximum voltage U ₀ Maximum current I ₀ Maximum power P ₀
	Conformance / approvals Conformance ATEX
	IECEX UL, USA / Canada Functional safety (SIL)

Technical data

Pt, Ni, Cu sensors: 2, 3, 4-conductor 0 Ω ... 2000 Ω 50 Ω per line (200 µA ... 1 mA) min. 50 K
0 mA ... 20 mA / 4 mA ... 20 mA max. 500 Ω As per NE 43 or can be freely defined < 50 µA _{pp}
19.2 V DC ... 30 V DC (24 V DC (-20% ... +25%)) < 40 mA (24 V DC) < 1 W 0.01%/K Typ. 800 ms (With SIL) max. 1200 ms (With SIL) Typ. 700 ms (Without SIL) max. 1100 ms (Without SIL)
0.05% x 100 [K] / measuring range span [K] + 0.05% ±5% / ±5%
2.5 kV (50 Hz, 1 min., test voltage) 300 V _{rms} (Rated insulation voltage, surge voltage category II; pollution degree 2, safe isolation as per EN 61010, EN 50178) 375 V (Peak value in accordance with EN 60079-11) 375 V (Peak value in accordance with EN 60079-11) -20°C ... 60°C (Any mounting position) 5% ... 95% (no condensation) Green LED (supply voltage, PWR) Red LED, flashing (line, sensor error, ERR) Red LED (module error, ERR) PA 66-FR V0 12.5 / 99 / 114.5 mm 0.2 ... 2.5 mm ² / 0.2 ... 2.5 mm ² / 24 - 14 0.2 ... 1.5 mm ² / 0.2 ... 1.5 mm ² / 24 - 16
6 V 6.3 mA 9.4 mW
CE-compliant, additionally EN 61326 Ex II (1) G [Ex ia Ga] IIC Ex II (1) D [Ex ia Da] IIC Ex II 3(1) G Ex nA ic [ia Ga] IIC T4 Gc X [Ex ia Ga] IIC; [Ex ia Da] IIC; Ex nA ic [ia Ga] IIC T4 Gc Class I Div 2; IS for Class I, II, III Div 1 SIL 2 TÜV Rheinland 968/EZ374.00/09

Notes:
To order a product with an order configuration, please enter the desired configuration by referring to the order key, see page 167
The configuration software can be downloaded from the Internet (www.phoenixcontact.net/products).
Information about the supply and error evaluation module as well as about the DIN rail connectors and marking material can be found from page 182
For information on the programming adapter, refer to page 119
Information on "Plug and play" connection using system cabling can be found from page 184
1) EMC: Class A product, see page 571

Ordering data

Type	Order No.	Pcs. / Pkt.
MACX MCR-EX-SL-RTD-I ¹⁾	2865939	1
MACX MCR-EX-SL-RTD-I-SP ¹⁾	2924142	1
MACX MCR-EX-SL-RTD-I-NC ¹⁾	2865573	1
MACX MCR-EX-SL-RTD-I-SP-NC ¹⁾	2924168	1

Accessories

IFS-USB-PROG-ADAPTER ¹⁾	2811271	1
------------------------------------	---------	---

Description	
Temperature measuring transducers for resistance thermometers, intrinsically safe input	
Order configuration	Screw connection
Order configuration	Spring-cage conn.
Standard configuration	Screw connection
Standard configuration	Spring-cage conn.

Programming adapter for configuring modules with S-PORT interface
--

Temperature transducer, Ex i

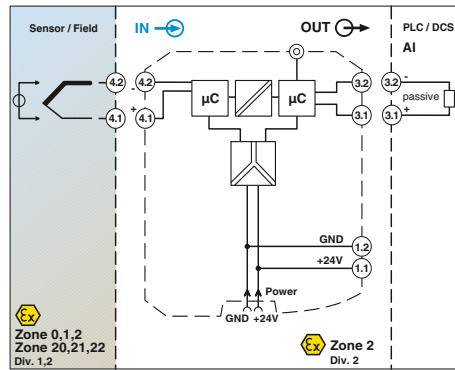
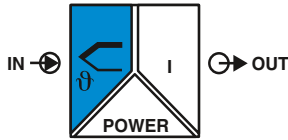

For thermocouples and mV sources

Ex: Ex i, Ex ii, Ex ia, Ex ib, Ex ic
 Housing width 12.5 mm

Programmable temperature transducer for intrinsically safe operation of thermocouples and mV sources installed in Ex areas. The measured values are converted into a linear 0 ... 20 mA or 4 ... 20 mA signal.

- Input for thermocouples and mV sources, [Ex ia]
- 0 ... 20 mA or 4 ... 20 mA output
- Configuration via software (FDT/DTM): Sensor type, connection method, measuring range, measuring unit, filter, alarm signal, and output range
- Programming during operation with Ex measuring circuit connected and also voltage-free using IFS-USB-PROG-ADAPTER programming adapter
- Status indicator for supply voltage, cable, sensor, and module errors
- 3-way electrical isolation
- Power supply via DIN rail connector possible
- Up to SIL 2 according to EN 61508
- Installation in zone 2 permitted

Notes:
To order a product with an order configuration, please enter the desired configuration by referring to the order key, see page 167
The configuration software can be downloaded from the Internet (www.phoenixcontact.net/products).
Information about the supply and error evaluation module as well as about the DIN rail connectors and marking material can be found from page 182
For information on the programming adapter, refer to page 119
Information on "Plug and play" connection using system cabling can be found from page 184
1) EMC: Class A product, see page 571

Input data	Thermocouple sensors
Voltage	
Measuring range span	
Output data	
Output signal	
Load	
Behavior in the event of a sensor error	
Output ripple	
General data	
Supply voltage range	
Current consumption	
Power dissipation	
Temperature coefficient	
Step response (0 - 99%)	
Transmission error, total	
Cold junction errors	
ZERO / SPAN adjustment	
Electrical isolation	
Ambient temperature range	
Humidity	
Status indication	
Housing material	
Inflammability class according to UL 94	
Dimensions W / H / D	
Screw connection solid / stranded / AWG	
Safety data as per ATEX	
Maximum voltage U_o	
Maximum current I_o	
Maximum power P_o	
Maximum voltage U_m	
Conformance / approvals	
Conformance	
ATEX	
IECEX	
UL, USA / Canada	
Functional safety (SIL)	

Technical data

E, J, K, N as per IEC / EN 60584, L as per DIN 43760

-20 mV ... 70 mV
 (Min. 50 K for thermocouples, 3 mV for mV sources)

0 mA ... 20 mA / 4 mA ... 20 mA
 max. 500 Ω
 As per NE 43 or can be freely defined
 < 50 µA_{pp}

19.2 V DC ... 30 V DC
 < 40 mA (24 V DC)
 < 1 W
 0.01%/K
 Typ. 800 ms (With SIL)
 max. 1200 ms (With SIL)
 Typ. 700 ms (Without SIL)
 max. 1100 ms (Without SIL)
 0.05% x 200 [K]/Measuring range span [K] + 0.05%
 ±1 K
 ±5% / ±5%

Input/output/power supply
 2.5 kV (50 Hz, 1 min., test voltage)
 300 V_{rms} (Rated insulation voltage, surge voltage category II; pollution degree 2, safe isolation as per EN 61010, EN 50178)

Input/output
Input/power supply
 375 V (Peak value in accordance with EN 60079-11)
 375 V (Peak value in accordance with EN 60079-11)
 -20°C ... 60°C (Any mounting position)
 5% ... 95% (no condensation)
 Green LED (supply voltage, PWR)
 Red LED, flashing (line, sensor error, ERR)
 Red LED (module error, ERR)

PA 66-FR
 V0
 12.5 / 99 / 114.5 mm
 0.2 ... 2.5 mm² / 0.2 ... 2.5 mm² / 24 - 14
 6 V
 4.7 mA
 7 mW
 253 V AC (125 V DC)

CE-compliant, additionally EN 61326
 Ex II (1) G [Ex ia Ga] IIC
 Ex II (1) D [Ex ia Da] IIIC
 Ex II 3(1) G Ex nA ic [ia Ga] IIC T4 Gc X
 [Ex ia Ga] IIC; [Ex ia Da] IIIC; Ex nA ic [ia Ga] IIC T4 Gc
 Class I Div 2; IS for Class I, II, III Div 1
 SIL 2 TÜV Rheinland 968/EZ374.00/09

Ordering data

Type	Order No.	Pcs. / Pkt.
MACX MCR-EX-SL-TC-1 ¹⁾	2865942	1
MACX MCR-EX-SL-TC-1-NC ¹⁾	2865586	1

Accessories

IFS-USB-PROG-ADAPTER ¹⁾	2811271	1
------------------------------------	---------	---

Description	
Temperature measuring transducers for thermocouples,	
intrinsically safe input	
Order configuration	Screw connection
Standard configuration	Screw connection
Programming adapter for configuring modules with S-PORT interface	

Order key and temperature ranges for MACX-MCR-EX-SL-RTD-I(-SP) temperature transducer

Order key for MACX-MCR-EX-SL-RTD-I(-SP) temperature transducer (standard configuration entered as an example)

Order No.	Sensor type	Safety integrity level (SIL)	Connection technology	Measuring range:		Measuring unit	Output range	Filter Oversampling	Filter Moving average value																																																												
				Start	End																																																																
2865939	PT100	ON	3	0	100	C	OUT02	10	1																																																												
2865939 ≙ MACX MCR-EX-SL-RTD-I	see below	ON ≙ active NONE ≙ not active ON only with output range = OUT02	2 ≙ 2-conductor 3 ≙ 3-conductor 4 ≙ 4-conductor	see below	see below	C ≙ °C F ≙ °F O ≙ Ω	OUT01 ≙ 0...20 mA OUT02 ≙ 4...20 mA	1 ≙ 1 value 3 ≙ 3 values 5 ≙ 5 values 7 ≙ 7 values 10 ≙ 10 values 20 ≙ 20 values	1 ≙ 1 value 2 ≙ 2 values 3 ≙ 3 values 4 ≙ 4 values																																																												
2924142 ≙ MACX MCR-EX-SL-RTD-I-SP				<table border="1"> <thead> <tr> <th></th> <th>Start</th> <th>End</th> <th>Unit</th> <th>Smallest measuring range span</th> </tr> </thead> <tbody> <tr> <td>RES01 ≙ Resistor</td> <td>0</td> <td>2000</td> <td>Ω</td> <td>25 Ω</td> </tr> <tr> <td>PT50 ≙ Pt 50 acc. to IEC 751</td> <td>-200</td> <td>850</td> <td>°C</td> <td>50 K</td> </tr> <tr> <td>PT100 ≙ Pt 100 acc. to IEC 751</td> <td>-200</td> <td>850</td> <td>°C</td> <td>50 K</td> </tr> <tr> <td>PT200 ≙ Pt 200 acc. to IEC 751</td> <td>-200</td> <td>850</td> <td>°C</td> <td>50 K</td> </tr> <tr> <td>PT500 ≙ Pt 500 acc. to IEC 751</td> <td>-200</td> <td>850</td> <td>°C</td> <td>50 K</td> </tr> <tr> <td>PT100S ≙ Pt 100 acc. to Sama RC21-4-1966</td> <td>-200</td> <td>600</td> <td>°C</td> <td>50 K</td> </tr> <tr> <td>PT500S ≙ Pt 500 acc. to Sama RC21-4-1966</td> <td>-200</td> <td>600</td> <td>°C</td> <td>50 K</td> </tr> <tr> <td>Ni100DIN ≙ Ni 100 acc. to DIN 43760</td> <td>-60</td> <td>250</td> <td>°C</td> <td>50 K</td> </tr> <tr> <td>Ni500DIN ≙ Ni 500 acc. to DIN 43760</td> <td>-60</td> <td>250</td> <td>°C</td> <td>50 K</td> </tr> <tr> <td>CU50 ≙ CU50 acc. to GOST 6651 (α = 1.428)</td> <td>-50</td> <td>200</td> <td>°C</td> <td>50 K</td> </tr> <tr> <td>CU53 ≙ CU53 acc. to GOST 6651 (α = 1.426)</td> <td>-50</td> <td>180</td> <td>°C</td> <td>50 K</td> </tr> </tbody> </table>			Start	End	Unit	Smallest measuring range span	RES01 ≙ Resistor	0	2000	Ω	25 Ω	PT50 ≙ Pt 50 acc. to IEC 751	-200	850	°C	50 K	PT100 ≙ Pt 100 acc. to IEC 751	-200	850	°C	50 K	PT200 ≙ Pt 200 acc. to IEC 751	-200	850	°C	50 K	PT500 ≙ Pt 500 acc. to IEC 751	-200	850	°C	50 K	PT100S ≙ Pt 100 acc. to Sama RC21-4-1966	-200	600	°C	50 K	PT500S ≙ Pt 500 acc. to Sama RC21-4-1966	-200	600	°C	50 K	Ni100DIN ≙ Ni 100 acc. to DIN 43760	-60	250	°C	50 K	Ni500DIN ≙ Ni 500 acc. to DIN 43760	-60	250	°C	50 K	CU50 ≙ CU50 acc. to GOST 6651 (α = 1.428)	-50	200	°C	50 K	CU53 ≙ CU53 acc. to GOST 6651 (α = 1.426)	-50	180	°C	50 K				
	Start	End	Unit	Smallest measuring range span																																																																	
RES01 ≙ Resistor	0	2000	Ω	25 Ω																																																																	
PT50 ≙ Pt 50 acc. to IEC 751	-200	850	°C	50 K																																																																	
PT100 ≙ Pt 100 acc. to IEC 751	-200	850	°C	50 K																																																																	
PT200 ≙ Pt 200 acc. to IEC 751	-200	850	°C	50 K																																																																	
PT500 ≙ Pt 500 acc. to IEC 751	-200	850	°C	50 K																																																																	
PT100S ≙ Pt 100 acc. to Sama RC21-4-1966	-200	600	°C	50 K																																																																	
PT500S ≙ Pt 500 acc. to Sama RC21-4-1966	-200	600	°C	50 K																																																																	
Ni100DIN ≙ Ni 100 acc. to DIN 43760	-60	250	°C	50 K																																																																	
Ni500DIN ≙ Ni 500 acc. to DIN 43760	-60	250	°C	50 K																																																																	
CU50 ≙ CU50 acc. to GOST 6651 (α = 1.428)	-50	200	°C	50 K																																																																	
CU53 ≙ CU53 acc. to GOST 6651 (α = 1.426)	-50	180	°C	50 K																																																																	
Alarm signal Short circuit/ overrange		Alarm signal Sensor break/ underrange		Factory calibration certificate = FCC																																																																	
...	I035	I215	NONE																																																																		
	I000 ≙ 0 mA I035 ≙ 3.5 mA I215 ≙ 21.5 mA I035 only with output range = OUT02 Alarm signals can also be configured individually using software.	I000 ≙ 0 mA I035 ≙ 3.5 mA I215 ≙ 21.5 mA	NONE ≙ without FCC YES ≙ with FCC (a fee is charged) YESPLUS ≙ FCC with 5 measuring points (a fee is charged)																																																																		
				Temperature conversion guide for °C to °F: $T [°F] = \frac{9}{5} T [°C] + 32$																																																																	

Order key and temperature ranges for MACX-MCR-EX-SL-TC-I temperature transducer

Order key for MACX-MCR-EX-SL-TC-I temperature transducer (standard configuration entered as an example)

Order No.	Sensor type	Safety integrity level (SIL)	Cold junction compensation	Measuring range:		Measuring unit	Output range	Filter Oversampling	Filter Moving average value																																		
				Start	End																																						
2924942	J	ON	1	0	1000	C	OUT02	10	1																																		
MACX MCR-EX-SL-TC-I	see below	ON ≙ active NONE ≙ not active ON only with output range = OUT02	1 ≙ switched on 0 ≙ switched off (e.g., for mV voltage measurement)	see below	see below	C ≙ °C F ≙ °F V ≙ mV	OUT01 ≙ 0...20 mA OUT02 ≙ 4...20 mA	1 ≙ 1 value 3 ≙ 3 values 5 ≙ 5 values 7 ≙ 7 values 10 ≙ 10 values 20 ≙ 20 values	1 ≙ 1 value 2 ≙ 2 values 3 ≙ 3 values 4 ≙ 4 values																																		
			<table border="1"> <thead> <tr> <th></th> <th>Start</th> <th>End</th> <th>Unit</th> <th>Smallest measuring range span</th> </tr> </thead> <tbody> <tr> <td>V03 ≙ Voltage (mV)</td> <td>-20</td> <td>+70</td> <td>mV</td> <td>3 mV</td> </tr> <tr> <td>E ≙ acc. to IEC 584-1 (NiCr-CuNi)</td> <td>-250</td> <td>1000</td> <td>°C</td> <td>50 K</td> </tr> <tr> <td>J ≙ acc. to IEC 584-1 (Fe-CuNi)</td> <td>-210</td> <td>1200</td> <td>°C</td> <td>50 K</td> </tr> <tr> <td>K ≙ acc. to IEC 584-1 (NiCr-Ni)</td> <td>-250</td> <td>1372</td> <td>°C</td> <td>50 K</td> </tr> <tr> <td>N ≙ acc. to IEC 584-1 (NiCrSi-NiSi)</td> <td>-250</td> <td>1300</td> <td>°C</td> <td>50 K</td> </tr> <tr> <td>L ≙ acc. to DIN 43760 (Fe-CuNi)</td> <td>-200</td> <td>900</td> <td>°C</td> <td>50 K</td> </tr> </tbody> </table>			Start	End	Unit	Smallest measuring range span	V03 ≙ Voltage (mV)	-20	+70	mV	3 mV	E ≙ acc. to IEC 584-1 (NiCr-CuNi)	-250	1000	°C	50 K	J ≙ acc. to IEC 584-1 (Fe-CuNi)	-210	1200	°C	50 K	K ≙ acc. to IEC 584-1 (NiCr-Ni)	-250	1372	°C	50 K	N ≙ acc. to IEC 584-1 (NiCrSi-NiSi)	-250	1300	°C	50 K	L ≙ acc. to DIN 43760 (Fe-CuNi)	-200	900	°C	50 K				
	Start	End	Unit	Smallest measuring range span																																							
V03 ≙ Voltage (mV)	-20	+70	mV	3 mV																																							
E ≙ acc. to IEC 584-1 (NiCr-CuNi)	-250	1000	°C	50 K																																							
J ≙ acc. to IEC 584-1 (Fe-CuNi)	-210	1200	°C	50 K																																							
K ≙ acc. to IEC 584-1 (NiCr-Ni)	-250	1372	°C	50 K																																							
N ≙ acc. to IEC 584-1 (NiCrSi-NiSi)	-250	1300	°C	50 K																																							
L ≙ acc. to DIN 43760 (Fe-CuNi)	-200	900	°C	50 K																																							
Alarm signal Overrange		Alarm signal Sensor break/ underrange		Factory calibration certificate = FCC																																							
...	I035	I215	NONE																																								
	I000 ≙ 0 mA I035 ≙ 3.5 mA I215 ≙ 21.5 mA I035 only with output range = OUT02 Alarm signals can also be configured individually using software.	I000 ≙ 0 mA I035 ≙ 3.5 mA I215 ≙ 21.5 mA	NONE ≙ without FCC YES ≙ with FCC (a fee is charged) YESPLUS ≙ FCC with 5 measuring points (a fee is charged)																																								
				Temperature conversion guide for °C to °F: $T [°F] = \frac{9}{5} T [°C] + 32$																																							

Temperature transducer, Ex i

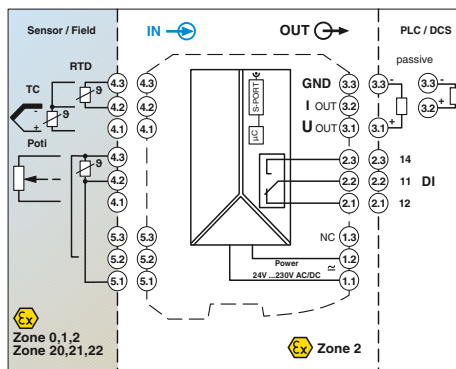
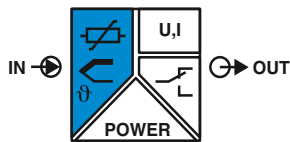

Universal, with switching output, wide-range power supply

Universal temperature transducer with freely configurable properties for intrinsically safe operation of resistance thermometers, thermocouples, resistance-type sensors, and potentiometers installed in Ex areas

- Input for resistance thermometers, thermocouples, resistance-type sensors, potentiometers, and mV sources, [Ex ia]
- Measure differential temperatures
- Freely programmable input and output
- Option of inverse output signal ranges
- Relay switching output
- Configuration via software (FDT-DTM) or IFS-OP-UNIT operating and display unit
- Programming during operation with Ex measuring circuit connected and also voltage-free using IFS-USB-PROG-ADAPTER programming adapter
- Plug-in capable screw or spring-cage connection method
- Cold junction compensation with separate connector
- Wide-range power supply: 19.2 ... 253 V AC/DC
- Status indicator for supply voltage, cable, sensor, and module errors
- Up to SIL 2 according to EN 61508
- Installation in zone 2 permitted

Input data	
Resistance thermometers	
Thermocouple sensors	
Resistor	
Potentiometer	
Voltage	
Output data	
Output signal	
Switching output	
Contact type	
Contact material	
Maximum switching voltage	
Maximum switching current	
General data	
Supply voltage range	
Power consumption	
Temperature coefficient	
Transmission error, total	
Electrical isolation	
Input/output/power supply	
Input/output	
Input/power supply	
Input/switching output	
Output/power supply	
Ambient temperature range	
Humidity	
Housing material	
Inflammability class according to UL 94	
Dimensions W / H / D	
Screw connection solid / stranded / AWG	
Spring-cage connection (solid/stranded/AWG)	
Safety data as per ATEX	
Maximum voltage U_o	
Maximum current I_o	
Maximum power P_o	
Conformance / approvals	
Conformance	
ATEX	
IECEX	
Functional safety (SIL)	

Functional safety
Ex: Ex i
Housing width 17.5 mm

Technical data	
Pt, Ni, Cu sensors: 2, 3, 4-conductor	
B, E, J, K, N, R, S, T, L, U, CA, DA, A1G, A2G, A3G, MG, LG	
0 Ω ... 50 kΩ	
0 Ω ... 50 kΩ	
-1000 mV ... 1000 mV	
U output	I output
4 mA ... 20 mA (in the case of SIL; further free configuration without SIL)	
±11 V	22 mA
≥ 10 kΩ	≤ 600 Ω (20 mA)
According to NE 43 or freely configurable	
Switching output	
1 PDT	
AgSnO ₂ , hard gold-plated	
30 V AC (30 V DC)	
0.5 A (30 V AC) / 1 A (30 V DC)	
24 V ... 230 V AC/DC (-20%/+10%, 50/60 Hz)	
< 1.5 W	
0.01%/K	
< 0.1% (e.g., for Pt 100, 300 K span, 4 ... 20 mA)	
2.5 kV (50 Hz, 1 min., test voltage)	
375 V (Peak value in accordance with EN 60079-11)	
375 V (Peak value in accordance with EN 60079-11)	
375 V (Peak value in accordance with EN 60079-11)	
300 V _{rms} (Rated insulation voltage, surge voltage category II; pollution degree 2, safe isolation as per EN 61010, EN 50178)	
-20°C ... 65°C	
Typ. 5% ... 95% (no condensation)	
PA 66-FR	
V0	
17.5 / 99 / 114.5 mm	
0.2 ... 2.5 mm ² / 0.2 ... 2.5 mm ² / 24 - 14	
0.2 ... 1.5 mm ² / 0.2 ... 1.5 mm ² / 24 - 16	
6 V	
7.4 mA	
11 mW	
CE-compliant	
Ex i II (1) G [Ex ia Ga] IIC	
Ex i II (1) D [Ex ia Da] IIIC	
Ex i II 3 G Ex nA nC ic IIC T4 Gc X	
[Ex ia Ga] IIC; [Ex ia Da] IIIC; Ex nA nC ic IIC T4 Gc	
SIL 2, PL d	

Notes:
To order a product with an order configuration, enter the required configuration by referring to the adjacent order key.
The configuration software can be downloaded from the Internet (www.phoenixcontact.net/products).
Information on the IFS-OP-UNIT operating and display unit and the associated IFS-OP-CRADLE DIN rail cradle can be found on page 118
For information on the programming adapter, refer to page 119
1) EMC: Class A product, see page 571

Description	
Temperature transducer, intrinsically safe input	
Standard configuration	Screw connection
Standard configuration	Spring-cage conn.
Order configuration	Screw connection
Order configuration	Spring-cage conn.

Programming adapter for configuring modules with S-PORT interface	
---	--

Ordering data		
Type	Order No.	Pcs. / Pkt.
MACX MCR-EX-T-UI-UP ¹⁾	2865654	1
MACX MCR-EX-T-UI-UP-SP ¹⁾	2924689	1
MACX MCR-EX-T-UI-UP-C ¹⁾	2811763	1
MACX MCR-EX-T-UI-UP-SP-C ¹⁾	2924692	1

Accessories		
IFS-USB-PROG-ADAPTER ¹⁾	2811271	1

Ex i isolating amplifiers with SIL functional safety - MACX Analog Ex

Order key for MACX-MCR-EX-T-UI-UP(-SP)-C temperature transducer (standard configuration entered as an example)

Order No.	Safety integrity level (SIL)	Sensor type	Connection technology	Cold junction compensation	Measuring range:		Measuring unit	Output range	Factory calibration certificate = FCC
					Start	End			
2811763	ON	PT100	4	0	-50	150	C	OUT02	NONE
2811763 ≙ MACX MCR-EX-T-UI-UP-C	ON ≙ active NONE ≙ not active	see below	2 ≙ 2-conductor 3 ≙ 3-conductor 4 ≙ 4-conductor	0 ≙ off, e.g., with RTD, R, potentiometer, mV 1 ≙ on, e.g., with TC	see below	see below	C ≙ °C F ≙ °F O ≙ Ω P ≙ % V ≙ mV	OUT15 ≙ 0...5 mA OUT16 ≙ 0...10 mA OUT01 ≙ 0...20 mA OUT15 ≙ 0...5 mA OUT25 ≙ 1...5 mA OUT26 ≙ 2...10 mA OUT02 ≙ 4...20 mA OUT05 ≙ 0...5 V OUT03 ≙ 0...10 V OUT06 ≙ 1...5 V OUT04 ≙ 2...10 V OUT13 ≙ -5...+5 V OUT14 ≙ -10...+10 V Others can be freely configured in the software	NONE ≙ without FCC YES ≙ with FCC (a fee is charged) YESPLUS ≙ FCC with 5 measuring points (a fee is charged)
2924692 ≙ MACX MCR-EX-T-UI-UP-SP-C	ON only with output range = OUT02								
Resistance thermometers (RTD) Others can be selected or freely configured in the software.		PT100 ≙ Pt 100 acc. to IEC 751			-200	850	°C	20 K	Other setting options can be configured with the IFS-CONF software: - Freely configurable user characteristic curve with 30 interpolation points - Output behavior in the event of a short circuit, sensor break or overrange/underrange can be freely configured or set according to NE43 (standard configuration: NE43 upscale) - Filter setting (standard configuration: 1) - Restart after failsafe (standard configuration: ON) - Switching behavior: switching output ? (limit values, times, etc.) (standard configuration: OFF)
	PT200 ≙ Pt 200 acc. to IEC 751			-200	850	°C	20 K		
	PT500 ≙ Pt 500 acc. to IEC 751			-200	850	°C	20 K		
	PT1000 ≙ Pt 1000 acc. to IEC 751			-200	850	°C	20 K		
	PT100S ≙ Pt 100 acc. to Sama RC21-4-1966			-200	850	°C	20 K		
	PT1000S ≙ Pt 1000 acc. to Sama RC21-4-1966			-200	850	°C	20 K		
	PT100G ≙ Pt 100 acc. to GOST 6651-2009 (α = 0.00385)			-200	850	°C	20 K		
	PT1000G ≙ Pt 1000 acc. to GOST 6651-2009 (α = 0.00385)			-200	850	°C	20 K		
	PT100J ≙ Pt 100 acc. to JIS C1604/1997			-200	850	°C	20 K		
	PT1000J ≙ Pt 1000 acc. to JIS C1604/1997			-200	850	°C	20 K		
	NI100 ≙ Ni 100 acc. to DIN 43760/DIN IEC 60751			-60	250	°C	20 K		
	NI1000 ≙ Ni 1000 acc. to DIN 43760/DIN IEC 60751			-60	250	°C	20 K		
	NI100S ≙ Ni 100 acc. to Sama RC21-4-1966			-60	180	°C	20 K		
	NI1000S ≙ Ni 1000 acc. to Sama RC21-4-1966			-60	180	°C	20 K		
	NI1000L ≙ Ni 1000 (Landis & Gyr)			-50	160	°C	20 K		
	CU10 ≙ Cu 10 acc. to Sama RC21-4-1966			-70	500	°C	100 K		
	CU50 ≙ Cu 50 acc. to GOST 6651-2009 (α = 0.00428)			-50	200	°C	100 K		
	CU100 ≙ Cu 100 acc. to GOST 6651-20091 (α = 0.00428)			-50	200	°C	100 K		
	CU53 ≙ Cu 53 acc. to GOST 6651-2009 (α = 0.00426)			-50	180	°C	100 K		
	KTY81 ≙ KTY81-110 (Philips)			-55	150	°C	20 K		
	KTY84 ≙ KTY84-130 (Philips)			-40	300	°C	20 K		
Thermocouples (TC) Others can be selected in the software.		B ≙ acc. to IEC 584-1 (Pt30Rh-Pt6Rh)			500	1820	°C	50 K	
	E ≙ acc. to IEC 584-1 (NiCr-CuNi)			-230	1000	°C	50 K		
	J ≙ acc. to IEC 584-1 (Fe-CuNi)			-210	1200	°C	50 K		
	K ≙ acc. to IEC 584-1 (NiCr-Ni)			-250	1372	°C	50 K		
	N ≙ acc. to IEC 584-1 (NiCrSi-NiSi)			-250	1300	°C	50 K		
	R ≙ acc. to IEC 584-1 (Pt13Rh-Pt)			-50	1768	°C	50 K		
	S ≙ acc. to IEC 584-1 (Pt10Rh-Pt)			-50	1768	°C	50 K		
	T ≙ acc. to IEC 584-1 (Cu-CuNi)			-200	400	°C	50 K		
	L ≙ acc. to DIN 43760 (Fe-CuNi)			-200	900	°C	50 K		
	U ≙ acc. to DIN 43760 (Cu-CuNi)			-200	600	°C	50 K		
	CA ≙ C ASTM JE988 (2002)			0	2315	°C	50 K		
	DA ≙ D ASTM JE988 (2002)			0	2315	°C	50 K		
	A1G ≙ A-1 GOST 8.585-2001			0	2500	°C	50 K		
	A2G ≙ A-2 GOST 8.585-2001			0	1800	°C	50 K		
	A3G ≙ A-3 GOST 8.585-2001			0	1800	°C	50 K		
	MG ≙ M GOST 8.585-2001			-200	100	°C	50 K		
	LG ≙ L GOST 8.585-2001			-200	800	°C	50 K		
Remote resistance-type sensors (R) (2, 3, 4-conductor) Others can be selected in the software.		RES03 ≙ 0...150 Ω resistor			0	150	Ω	10% of the selected measuring range	
	RES05 ≙ 0...600 Ω resistor			0	600	Ω			
	RES06 ≙ 0...1200 Ω resistor			0	1200	Ω			
	RES09 ≙ 0...6250 Ω resistor			0	6250	Ω			
	RES10 ≙ 0...12500 Ω resistor			0	12500	Ω			
	RES12 ≙ 0...50000 Ω resistor			0	50000	Ω			
Potentiometers (3-conductor) Others can be selected in the software.		POT03 ≙ 0...150 Ω potentiometer			0	100	%	10% of the selected measuring range	
	POT05 ≙ 0...600 Ω potentiometer			0	100	%			
	POT06 ≙ 0...1200 Ω potentiometer			0	100	%			
	POT09 ≙ 0...6250 Ω potentiometer			0	100	%			
	POT10 ≙ 0...12500 Ω potentiometer			0	100	%			
	POT12 ≙ 0...50000 Ω potentiometer			0	100	%			
Voltage signals (mV) Others can be selected in the software.		V04 ≙ Voltage (mV)			-1000	+1000	mV	10% of nominal span	

Temperature conversion guide for °C to °F: $T [°F] = \frac{9}{5} T [°C] + 32$

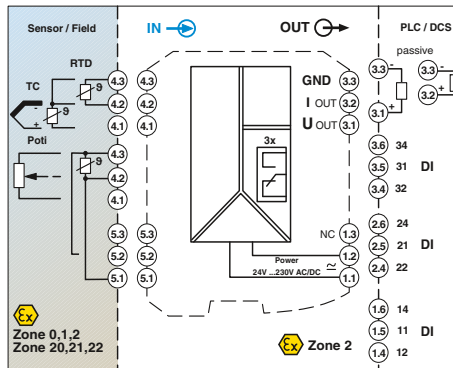
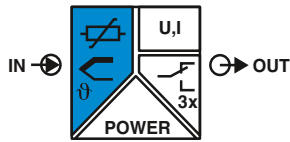

Universal, with three limit value relays, wide-range power supply

Functional safety
Ex:
Housing width 35 mm

Universal temperature transducer with freely configurable properties for intrinsically safe operation of resistance thermometers, thermocouples, resistance-type sensors, and potentiometers installed in Ex areas

- Input for resistance thermometers, thermocouples, resistance-type sensors, potentiometers, and mV sources, [Ex ia]
- Measure differential temperatures
- Freely programmable input and output
- Option of inverse output signal ranges
- Three limit value relays, can be used in combination as a safe limit value relay
- Configuration via software (FDT-DTM) or IFS-OP-UNIT operating and display unit
- Programming during operation with Ex measuring circuit connected and also voltage-free using IFS-USB-PROG-ADAPTER programming adapter
- Plug-in capable screw or spring-cage connection method
- Cold junction compensation with separate connector
- Wide-range power supply: 19.2 ... 253 V AC/DC
- Status indicator for supply voltage, cable, sensor, and module errors
- Up to SIL 2 according to EN 61508
- Installation in zone 2 permitted

Input data	Resistance thermometers Thermocouple sensors
Resistor Potentiometer Voltage	
Output data	Output signal
Maximum output signal Load R_B Behavior in the event of a sensor error	
Switching output	Contact type Contact material Maximum switching voltage Maximum switching current
General data	Supply voltage range Power consumption Temperature coefficient Transmission error, total Electrical isolation
Ambient temperature range Humidity Housing material Inflammability class according to UL 94 Dimensions W / H / D Screw connection solid / stranded / AWG Spring-cage connection (solid/stranded/AWG)	
Safety data as per ATEX	Maximum voltage U_o Maximum current I_o Maximum power P_o
Conformance / approvals	Conformance ATEX
IECEX Functional safety (SIL)	

Technical data	
Pt, Ni, Cu sensors: 2, 3, 4-conductor B, E, J, K, N, R, S, T, L, U, CA, DA, A1G, A2G, A3G, MG, LG	
0 Ω ... 50 k Ω 0 Ω ... 50 k Ω -1000 mV ... 1000 mV	
U output 4 mA ... 20 mA (in the case of SIL; further free configuration without SIL)	I output
± 11 V ≥ 10 k Ω	22 mA $\leq 600 \Omega$ (20 mA)
According to NE 43 or freely configurable	
Relay output	3 PDTs AgSnO ₂ , hard gold-plated 250 V AC (250 V DC) 2 A (250 V AC) / 2 A (28 V DC)
24 V ... 230 V AC/DC (-20%/+10%, 50/60 Hz) < 2.4 W 0.01%/K < 0.1% (e.g., for Pt 100, 300 K span, 4 ... 20 mA)	
Input/output/power supply Input/output Input/power supply Input/switching output Output/power supply	2.5 kV (50 Hz, 1 min., test voltage) 375 V (Peak value in accordance with EN 60079-11) 375 V (Peak value in accordance with EN 60079-11) 375 V (Peak value in accordance with EN 60079-11) 300 V _{rms} (Rated insulation voltage, surge voltage category II; pollution degree 2, safe isolation as per EN 61010, EN 50178)
-20°C ... 65°C Typ. 5% ... 95% (no condensation) PA 66-FR V0 35 / 99 / 114.5 mm 0.2 ... 2.5 mm ² / 0.2 ... 2.5 mm ² / 24 - 14 0.2 ... 1.5 mm ² / 0.2 ... 1.5 mm ² / 24 - 16	
6 V 7.4 mA 11 mW	
CE-compliant II (1) G [Ex ia Ga] IIC II (1) D [Ex ia Da] IIIC II 3 G Ex nA nC ic IIC T4 Gc X [Ex ia Ga] IIC; [Ex ia Da] IIIC; Ex nA nC ic IIC T4 Gc SIL 2, PL d	

Notes:
To order a product with an order configuration, enter the required configuration by referring to the adjacent order key.
The configuration software can be downloaded from the Internet (www.phoenixcontact.net/products).
Information on the IFS-OP-UNIT operating and display unit and the associated IFS-OP-CRADLE DIN rail cradle can be found on page 118
For information on the programming adapter, refer to page 119
1) EMC: Class A product, see page 571

Description	Temperature transducer, intrinsically safe input
Standard configuration	Screw connection
Standard configuration	Spring-cage conn.
Order configuration	Screw connection
Order configuration	Spring-cage conn.

Programming adapter for configuring modules with S-PORT interface

Ordering data		
Type	Order No.	Pcs. / Pkt.
MACX MCR-EX-T-UIREL-UP ¹⁾	2865751	1
MACX MCR-EX-T-UIREL-UP-SP ¹⁾	2924799	1
MACX MCR-EX-T-UIREL-UP-C ¹⁾	2865722	1
MACX MCR-EX-T-UIREL-UP-SP-C ¹⁾	2924809	1

Accessories		
IFS-USB-PROG-ADAPTER ¹⁾	2811271	1

Ex i isolating amplifiers with SIL functional safety - MACX Analog Ex

Order key for MACX-MCR-EX-T-UIREL-UP(-SP)-C temperature transducer (standard configuration entered as an example)

Order No.	Safety integrity level (SIL)	Sensor type	Connection technology	Cold junction compensation	Measuring range:		Measuring unit	Output range	Factory calibration certificate = FCC
					Start	End			
2865722	ON	PT100	4	0	-50	150	C	OUT02	NONE
2865722 ≙ MACX MCR-EX-T-UIREL-UP-C	ON ≙ active NONE ≙ not active	see below	2 ≙ 2-conductor 3 ≙ 3-conductor 4 ≙ 4-conductor	0 ≙ off, e.g., with RTD, R, potentiometer, mV 1 ≙ on, e.g., with TC	see below	see below	C ≙ °C F ≙ °F O ≙ Ω P ≙ % V ≙ mV	OUT15 ≙ 0...5 mA OUT16 ≙ 0...10 mA OUT01 ≙ 0...20 mA OUT15 ≙ 0...5 mA OUT25 ≙ 1...5 mA OUT26 ≙ 2...10 mA OUT02 ≙ 4...20 mA OUT05 ≙ 0...5 V OUT03 ≙ 0...10 V OUT06 ≙ 1...5 V OUT04 ≙ 2...10 V OUT13 ≙ -5...+5 V OUT14 ≙ -10...+10 V Others can be freely configured in the software	NONE ≙ without FCC YES ≙ with FCC (a fee is charged) YESPLUS ≙ FCC with 5 measuring points (a fee is charged)
2924809 ≙ MACX MCR-EX-T-UIREL-UP-SP-C	ON only with output range = OUT02								
Resistance thermometers (RTD) Others can be selected or freely configured in the software.		PT100 ≙ Pt 100 acc. to IEC 751			-200	850	°C	20 K	Other setting options can be configured with the IFS-CONF software: - Freely configurable user characteristic curve with 30 interpolation points - Output behavior in the event of a short circuit, sensor break or overrange/underrange can be freely configured or set according to NE43 (standard configuration: NE43 upscale) - Filter setting (standard configuration: 1) - Restart after failsafe (standard configuration: ON) - Switching behavior: switching output ? (limit values, times, etc.) (standard configuration: OFF)
	PT200 ≙ Pt 200 acc. to IEC 751			-200	850	°C	20 K		
	PT500 ≙ Pt 500 acc. to IEC 751			-200	850	°C	20 K		
	PT1000 ≙ Pt 1000 acc. to IEC 751			-200	850	°C	20 K		
	PT100S ≙ Pt 100 acc. to Sama RC21-4-1966			-200	850	°C	20 K		
	PT1000S ≙ Pt 1000 acc. to Sama RC21-4-1966			-200	850	°C	20 K		
	PT100G ≙ Pt 100 acc. to GOST 6651-2009 (α = 0.00385)			-200	850	°C	20 K		
	PT1000G ≙ Pt 1000 acc. to GOST 6651-2009 (α = 0.00385)			-200	850	°C	20 K		
	PT100J ≙ Pt 100 acc. to JIS C1604/1997			-200	850	°C	20 K		
	PT1000J ≙ Pt 1000 acc. to JIS C1604/1997			-200	850	°C	20 K		
	NI100 ≙ Ni 100 acc. to DIN 43760/DIN IEC 60751			-60	250	°C	20 K		
	NI1000 ≙ Ni 1000 acc. to DIN 43760/DIN IEC 60751			-60	250	°C	20 K		
	NI100S ≙ Ni 100 acc. to Sama RC21-4-1966			-60	180	°C	20 K		
	NI1000S ≙ Ni 1000 acc. to Sama RC21-4-1966			-60	180	°C	20 K		
	NI1000L ≙ Ni 1000 (Landis & Gyr)			-50	160	°C	20 K		
	CU10 ≙ Cu 10 acc. to Sama RC21-4-1966			-70	500	°C	100 K		
	CU50 ≙ Cu 50 acc. to GOST 6651-2009 (α = 0.00428)			-50	200	°C	100 K		
	CU100 ≙ Cu 100 acc. to GOST 6651-2009 (α = 0.00428)			-50	200	°C	100 K		
	CU53 ≙ Cu 53 acc. to GOST 6651-2009 (α = 0.00426)			-50	180	°C	100 K		
	KTY81 ≙ KTY81-110 (Philips)			-55	150	°C	20 K		
	KTY84 ≙ KTY84-130 (Philips)			-40	300	°C	20 K		
Thermocouples (TC) Others can be selected in the software.		B ≙ acc. to IEC 584-1 (Pt30Rh-Pt6Rh)			500	1820	°C	50 K	
	E ≙ acc. to IEC 584-1 (NiCr-CuNi)			-230	1000	°C	50 K		
	J ≙ acc. to IEC 584-1 (Fe-CuNi)			-210	1200	°C	50 K		
	K ≙ acc. to IEC 584-1 (NiCr-Ni)			-250	1372	°C	50 K		
	N ≙ acc. to IEC 584-1 (NiCrSi-NiSi)			-250	1300	°C	50 K		
	R ≙ acc. to IEC 584-1 (Pt13Rh-Pt)			-50	1768	°C	50 K		
	S ≙ acc. to IEC 584-1 (Pt10Rh-Pt)			-50	1768	°C	50 K		
	T ≙ acc. to IEC 584 (Cu-CuNi)			-200	400	°C	50 K		
	L ≙ acc. to DIN 43760 (Fe-CuNi)			-200	900	°C	50 K		
	U ≙ acc. to DIN 43760 (Cu-CuNi)			-200	600	°C	50 K		
	CA ≙ C ASTM JE988 (2002)			0	2315	°C	50 K		
	DA ≙ D ASTM JE988 (2002)			0	2315	°C	50 K		
	A1G ≙ A-1 GOST 8.585-2001			0	2500	°C	50 K		
	A2G ≙ A-2 GOST 8.585-2001			0	1800	°C	50 K		
	A3G ≙ A-3 GOST 8.585-2001			0	1800	°C	50 K		
	MG ≙ M GOST 8.585-2001			-200	100	°C	50 K		
	LG ≙ L GOST 8.585-2001			-200	800	°C	50 K		
Remote resistance-type sensors (R) (2, 3, 4-conductor) Others can be selected in the software.		RES03 ≙ 0...150 Ω resistor			0	150	Ω	10% of the selected measuring range	
	RES05 ≙ 0...600 Ω resistor			0	600	Ω			
	RES06 ≙ 0...1200 Ω resistor			0	1200	Ω			
	RES09 ≙ 0...6250 Ω resistor			0	6250	Ω			
	RES10 ≙ 0...12500 Ω resistor			0	12500	Ω			
	RES12 ≙ 0...50000 Ω resistor			0	50000	Ω			
Potentiometers (3-conductor) Others can be selected in the software.		POT03 ≙ 0...150 Ω potentiometer			0	100	%	10% of the selected measuring range	
	POT05 ≙ 0...600 Ω potentiometer			0	100	%			
	POT06 ≙ 0...1200 Ω potentiometer			0	100	%			
	POT09 ≙ 0...6250 Ω potentiometer			0	100	%			
	POT10 ≙ 0...12500 Ω potentiometer			0	100	%			
	POT12 ≙ 0...50000 Ω potentiometer			0	100	%			
Voltage signals (mV) Others can be selected in the software.		V04 ≙ Voltage (mV)			-1000	+1000	mV	10% of nominal span	

Temperature conversion guide for °C to °F: $T [°F] = \frac{9}{5} T [°C] + 32$

Digital IN
NAMUR isolating amplifier, Ex i

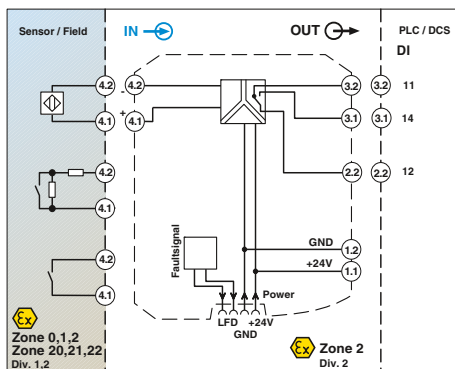
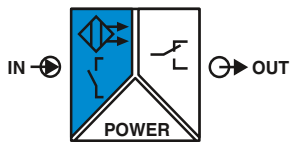

Signal output: PDT relay

Functional safety

Ex: Ex i

Housing width 12.5 mm

Technical data

NAMUR isolating amplifier for intrinsically safe operation of proximity sensors and mechanical contacts installed in Ex areas.

- Input for NAMUR proximity sensors (EN 60947-5-6), floating contacts or contacts with resistance circuit, [Ex ia]
- Relay signal output (PDT)
- Reversible direction of action (operating current or closed-circuit current behavior)
- Line fault detection (LFD), can be activated/deactivated, error message signaled by red flashing LED with de-excitation of output relay
- Power supply and error indication possible via the DIN rail connector
- LED displays for indicating supply voltage, circuit state, and malfunctions to NAMUR NE 44
- 3-way electrical isolation
- Up to SIL 2 according to EN 61508
- Installation in zone 2 permitted

Input data

Input signal

No-load voltage
Switching points
Switching hysteresis
Line error detection

Switching output

Contact type
Contact material
Maximum switching voltage
Maximum switching capacity
Recommended minimum load
Mechanical service life
Switching behavior
Maximum switching frequency

General data

Supply voltage range
Current consumption
Power dissipation
Number of channels
Electrical isolation

Input/output
Input/power supply
Input/output/supply, T-Connector

Ambient temperature range
Humidity
Status indication

Housing material
Inflammability class according to UL 94
Dimensions W / H / D
Screw connection solid / stranded / AWG
Spring-cage connection (solid/stranded/AWG)

Safety data as per ATEX

Maximum voltage U_o
Maximum current I_o
Maximum power P_o
Maximum voltage U_m

Conformance / approvals

Conformance
ATEX

IECEX
UL, USA / Canada
Functional safety (SIL)

NAMUR proximity sensors (EN 60947-5-6)
Floating switch contacts
Switch contacts with resistance circuit
8 V DC $\pm 10\%$
> 2.1 mA (conductive) / < 1.2 mA (blocking)
< 0.2 mA
Break 0.05 mA < I_N < 0.35 mA
Short-circuit 100 Ω < R_{sensor} < 360 Ω
Relay output
1 PDT
AgSnO₂, hard gold-plated
250 V AC (2 A) / 120 V DC (0.2 A) / 30 V DC (2 A)
500 VA
5 V / 10 mA
10⁷ cycles
Can be inverted via slide switch
20 Hz (without load)
19.2 V DC ... 30 V DC
21 mA (24 V DC)
< 650 mW
1
375 V (Peak value in accordance with EN 60079-11)
375 V (Peak value in accordance with EN 60079-11)
300 V_{rms} (Rated insulation voltage, surge voltage category II; pollution degree 2, basic insulation as per EN 61010, EN 50178)
2.5 kV (50 Hz, 1 min., test voltage)

-20°C ... 60°C (Any mounting position)
10% ... 95% (no condensation)
Green LED (supply voltage)
LED yellow (switching state)
Red LED (line errors)
PA 66-FR
V0
12.5 / 99 / 114.5 mm
0.2 ... 2.5 mm² / 0.2 ... 2.5 mm² / 24 - 14
0.2 ... 1.5 mm² / 0.2 ... 1.5 mm² / 24 - 16

9.6 V
10 mA
25 mW
253 V AC (125 V DC)

CE-compliant, additionally EN 61326
Ex (1) G [Ex ia Ga] IIC
Ex (1) D [Ex ia Da] IIIC
Ex II 3 G Ex nA nC IIC T4 Gc X
[Ex ia Ga] IIC; [Ex ia Da] IIIC; Ex nA nC IIC T4 Gc
Class I Div 2; IS for Class I, II, III Div 1
SIL 2 according to EN 61508

Ordering data

Description

NAMUR isolating amplifier, 1-channel, input intrinsically safe, output: PDT contact

Screw connection
Spring-cage conn.

Type	Order No.	Pcs. / Pkt.
MACX MCR-EX-SL-NAM-R ¹⁾	2865434	1
MACX MCR-EX-SL-NAM-R-SP ¹⁾	2924045	1

Notes:

Information about the supply and error evaluation module as well as about the DIN rail connectors and marking material can be found from page 182
Information about resistance circuits is given on page 183
Information on "Plug and play" connection using system cabling can be found from page 184
1) EMC: Class A product, see page 571

Digital IN
NAMUR isolating amplifier, Ex i

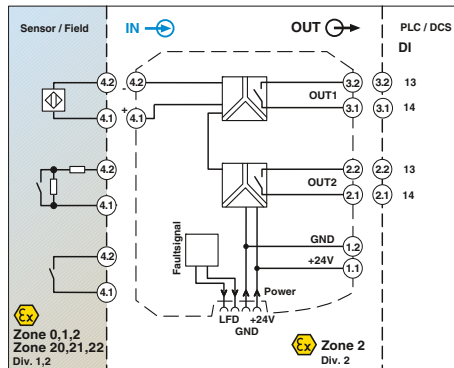
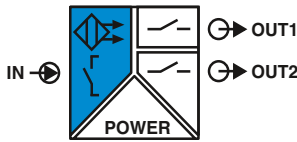

2 signal outputs: N/O contact relay

Functional safety
Ex: Ex i
Housing width 12.5 mm

NAMUR isolating amplifier for intrinsically safe operation of proximity sensors and mechanical contacts installed in Ex areas.

- Input for NAMUR proximity sensors (EN 60947-5-6), floating contacts or contacts with resistance circuit, [Ex ia]
- Two relay signal outputs (N/O contact); output 2 can be used as an error message output
- Reversible direction of action (operating current or closed-circuit current behavior)
- Line fault detection (LFD), can be activated/deactivated, error message signaled by red flashing LED with de-excitation of output relay
- Power supply and error indication possible via the DIN rail connector
- LED displays for indicating supply voltage, circuit state, and malfunctions to NAMUR NE 44
- 4-way electrical isolation
- Up to SIL 2 according to EN 61508
- Installation in zone 2 permitted

Input data
Input signal

No-load voltage
Switching points
Switching hysteresis
Line error detection

Switching output

Contact type
Contact material
Maximum switching voltage
Maximum switching capacity
Recommended minimum load
Mechanical service life
Switching behavior
Maximum switching frequency

General data

Supply voltage range
Current consumption
Power dissipation
Number of channels
Electrical isolation

Input/output
Input/power supply
Input/supply, T connector

Output 1/output 2/input, power supply, T connector

Ambient temperature range
Humidity
Status indication

Housing material
Inflammability class according to UL 94
Dimensions W / H / D
Screw connection solid / stranded / AWG
Spring-cage connection (solid/stranded/AWG)

Safety data as per ATEX

Maximum voltage U_o
Maximum current I_o
Maximum power P_o
Maximum voltage U_m

Conformance / approvals

Conformance
ATEX

IECEX
UL, USA / Canada
Functional safety (SIL)

Technical data

NAMUR proximity sensors (EN 60947-5-6)
Floating switch contacts
Switch contacts with resistance circuit
8 V DC $\pm 10\%$
> 2.1 mA (conductive) / < 1.2 mA (blocking)
< 0.2 mA
Break 0.05 mA < I_{IN} < 0.35 mA
Short-circuit 100 Ω < R_{Sensor} < 360 Ω
Relay output
2 N/O contacts
AgSnO₂, hard gold-plated
250 V AC (2 A) / 120 V DC (0.2 A) / 30 V DC (2 A)
500 VA
5 V / 10 mA
10⁷ cycles
Can be inverted via slide switch
20 Hz (without load)

19.2 V DC ... 30 V DC
30 mA (24 V DC)
< 950 mW
1
375 V (Peak value in accordance with EN 60079-11)
375 V (Peak value in accordance with EN 60079-11)
300 V_{rms} (Rated insulation voltage, surge voltage category II; pollution degree 2, basic insulation as per EN 61010, EN 50178)
2.5 kV (50 Hz, 1 min., test voltage)
300 V_{rms} (Rated insulation voltage, surge voltage category III; pollution degree 2, safe isolation as per EN 61010, EN 50178)
2.5 kV (50 Hz, 1 min., test voltage)
-20°C ... 60°C (Any mounting position)
10% ... 95% (no condensation)
Green LED (supply voltage)
LED yellow (switching state)
Red LED (line errors)
PA 66-FR
V0
12.5 / 99 / 114.5 mm
0.2 ... 2.5 mm² / 0.2 ... 2.5 mm² / 24 - 14
0.2 ... 1.5 mm² / 0.2 ... 1.5 mm² / 24 - 16

9.6 V
10 mA
25 mW
253 V AC (125 V DC)

CE-compliant, additionally EN 61326
Ex II (1) G [Ex ia Ga] IIC
Ex II (1) D [Ex ia Da] IIIC
Ex II 3 G Ex nA nC IIC T4 Gc X
[Ex ia Ga] IIC; [Ex ia Da] IIIC; Ex nA nC IIC T4 Gc
Class I Div 2; IS for Class I, II, III Div 1
SIL 2 according to EN 61508

Ordering data

Description

NAMUR isolating amplifier, 1-channel, input intrinsically safe, output: 2 N/O contacts
Screw connection
Spring-cage conn.

Type	Order No.	Pcs. / Pkt.
MACX MCR-EX-SL-NAM-2RO ¹⁾	2865450	1
MACX MCR-EX-SL-NAM-2RO-SP ¹⁾	2924061	1

Notes:

Information about the supply and error evaluation module as well as about the DIN rail connectors and marking material can be found from page 182

Information about resistance circuits is given on page 183

Information on "Plug and play" connection using system cabling can be found from page 184

1) EMC: Class A product, see page 571

Digital IN

NAMUR isolating amplifier, Ex i

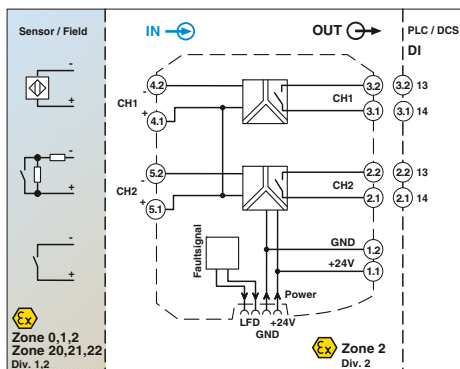
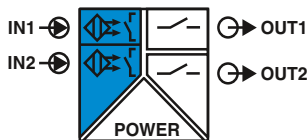

2-channel, signal output: N/O contact relay

Functional safety

Ex: Ex i

Housing width 12.5 mm

Technical data

NAMUR proximity sensors (EN 60947-5-6)
 Floating switch contacts
 Switch contacts with resistance circuit
 8 V DC ±10%
 > 2.1 mA (conductive) / < 1.2 mA (blocking)
 < 0.2 mA
 Break 0.05 mA < I_N < 0.35 mA
 Short-circuit 100 Ω < R_{sensor} < 360 Ω
 Relay output
 2 N/O contacts
 AgSnO₂, hard gold-plated
 250 V AC (2 A) / 120 V DC (0.2 A) / 30 V DC (2 A)
 500 VA
 5 V / 10 mA
 10⁷ cycles
 Can be inverted via slide switch
 20 Hz (without load)

19.2 V DC ... 30 V DC
 35 mA (24 V DC)
 < 1 W
 2
 375 V (Peak value in accordance with EN 60079-11)
 375 V (Peak value in accordance with EN 60079-11)
 300 V_{rms} (Rated insulation voltage, surge voltage category II; pollution degree 2, basic insulation as per EN 61010, EN 50178)
 2.5 kV (50 Hz, 1 min., test voltage)
 300 V_{rms} (Rated insulation voltage, surge voltage category III; pollution degree 2, safe isolation as per EN 61010, EN 50178)
 2.5 kV (50 Hz, 1 min., test voltage)
 -20°C ... 60°C (Any mounting position)
 5% ... 95% (no condensation)
 Green LED (supply voltage)
 LED yellow (switching state)
 Red LED (line errors)
 PA 66-FR
 V0
 12.5 / 99 / 114.5 mm
 0.2 ... 2.5 mm² / 0.2 ... 2.5 mm² / 24 - 14
 0.2 ... 1.5 mm² / 0.2 ... 1.5 mm² / 24 - 16

9.6 V
 10.3 mA
 25 mW
 253 V AC (125 V DC)

CE-compliant, additionally EN 61326
 Ex II (1) G [Ex ia Ga] IIC
 Ex II (1) D [Ex ia Da] IIIC
 Ex II 3 G Ex nA nC IIC T4 Gc X
 [Ex ia Ga] IIC; [Ex ia Da] IIIC; Ex nA nC IIC T4 Gc
 Class I Div 2; IS for Class I, II, III Div 1
 SIL 2 according to EN 61508

Ordering data

Type	Order No.	Pcs. / Pkt.
MACX MCR-EX-SL-2NAM-RO ¹⁾	2865476	1
MACX MCR-EX-SL-2NAM-RO-SP ¹⁾	2924087	1

NAMUR isolating amplifier for intrinsically safe operation of proximity sensors and mechanical contacts installed in Ex areas.

- 2-channel
- Input for NAMUR proximity sensors (EN 60947-5-6), floating contacts or contacts with resistance circuit, [Ex ia]
- Relay signal output (N/O contact)
- Reversible direction of action (operating current or closed-circuit current behavior)
- Line fault detection (LFD), can be activated/deactivated, error message signaled by red flashing LED with de-excitation of output relay
- Power supply and error indication possible via the DIN rail connector
- LED displays for indicating supply voltage, circuit state, and malfunctions to NAMUR NE 44
- 3-way electrical isolation
- Up to SIL 2 according to EN 61508
- Installation in zone 2 permitted

Notes:
Information about the supply and error evaluation module as well as about the DIN rail connectors and marking material can be found from page 182
Information about resistance circuits is given on page 183
Information on "Plug and play" connection using system cabling can be found from page 184
1) EMC: Class A product, see page 571

Input data	Input signal
No-load voltage	
Switching points	
Switching hysteresis	
Line error detection	
Switching output	
Contact type	
Contact material	
Maximum switching voltage	
Maximum switching capacity	
Recommended minimum load	
Mechanical service life	
Switching behavior	
Maximum switching frequency	
General data	
Supply voltage range	
Current consumption	
Power dissipation	
Number of channels	
Electrical isolation	
	Input/output
	Input/power supply
	Input/supply, T connector
	Output 1/output 2/input, power supply, T connector
Ambient temperature range	
Humidity	
Status indication	
Housing material	
Inflammability class according to UL 94	
Dimensions W / H / D	
Screw connection solid / stranded / AWG	
Spring-cage connection (solid/stranded/AWG)	
Safety data as per ATEX	
Maximum voltage U _o	
Maximum current I _o	
Maximum power P _o	
Maximum voltage U _m	
Conformance / approvals	
Conformance	
ATEX	
IECEX	
UL, USA / Canada	
Functional safety (SIL)	

Description
NAMUR isolating amplifier, 2-channel, input intrinsically safe, output: N/O contact
Screw connection
Spring-cage conn.

Digital IN
NAMUR isolating amplifier, Ex i

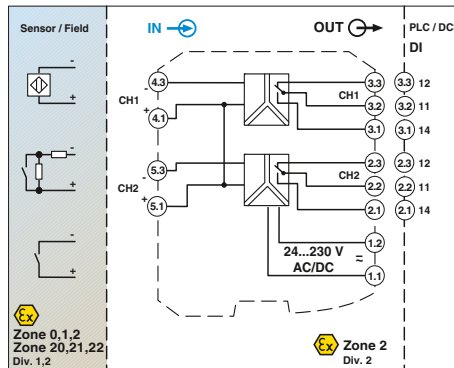
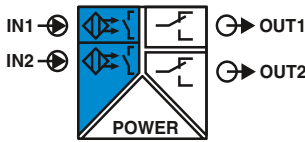

2-channel, signal output: PDT relay, wide-range power supply

Functional safety
Ex: // Applied for: cUL / UL
Housing width 17.5 mm

NAMUR isolating amplifier for intrinsically safe operation of proximity sensors and mechanical contacts installed in Ex areas.

- 2-channel
- Input for NAMUR proximity sensors (EN 60947-5-6), floating contacts or contacts with resistance circuit, [Ex ia]
- Relay signal output (PDT)
- Reversible direction of action (operating current or closed-circuit current behavior)
- Line fault detection (LFD), can be activated/deactivated, error message signaled by red flashing LED with de-excitation of output relay
- Wide-range power supply: 19.2 ... 253 V AC/DC
- LED displays for indicating supply voltage, circuit state, and malfunctions to NAMUR NE 44
- 3-way electrical isolation
- Up to SIL 2 according to EN 61508
- Installation in zone 2 permitted

Input data	
Input signal	
No-load voltage	
Switching points	
Switching hysteresis	
Line error detection	
Switching output	
Contact type	
Contact material	
Maximum switching voltage	
Maximum switching capacity	
Recommended minimum load	
Mechanical service life	
Switching behavior	
Max. switching frequency	
General data	
Supply voltage range	
Current consumption	
Power dissipation	
Electrical isolation	
Input/output	375 V (Peak value in accordance with EN 60079-11)
Input/power supply	375 V (Peak value in accordance with EN 60079-11)
	300 V _{rms} (Rated insulation voltage, surge voltage category II; pollution degree 2, safe isolation as per EN 61010, EN 50178)
	2.5 kV AC (50 Hz, 1 min., test voltage)
Output 1/output 2/input, power supply	300 V _{rms} (Rated insulation voltage, surge voltage category III; pollution degree 2, safe isolation as per EN 61010, EN 50178)
	2.5 kV (50 Hz, 1 min., test voltage)
Ambient temperature range	-20°C ... 60°C
Humidity	10% ... 95% (no condensation)
Housing material	PA 66-FR
Inflammability class according to UL 94	V0
Dimensions W / H / D	17.5 / 99 / 114.5 mm
Screw connection solid / stranded / AWG	0.2 ... 2.5 mm ² / 0.2 ... 2.5 mm ² / 24 - 14
Spring-cage connection (solid/stranded/AWG)	0.2 ... 1.5 mm ² / 0.2 ... 1.5 mm ² / 24 - 16
Safety data as per ATEX	
Maximum voltage U _o	9.6 V
Maximum current I _o	10.3 mA
Maximum power P _o	25 mW
Maximum voltage U _m	253 V AC/DC (Supply terminals)
	250 V AC (Output terminals)
	120 V DC (Output terminals)
Conformance / approvals	
Conformance	
ATEX	
IECEX	
Functional safety (SIL)	
CE-compliant, additionally EN 61326	
II (1) G [Ex ia Ga] IIC	
II (1) D [Ex ia Da] IIIC	
II 3(1) G Ex nA nC [ia Ga] IIC T4 Gc X	
[Ex ia Ga] IIC; [Ex ia Da] IIIC; Ex nA nC [ia Ga] IIC T4 Gc	
SIL 2 according to EN 61508	

Technical data

Technical data	
NAMUR proximity sensors (EN 60947-5-6)	
open circuit switch contacts	
Switch contacts with resistance circuit	
8 V DC ±10%	
> 2.1 mA (conductive) / < 1.2 mA (blocking)	
Approx. 0.2 mA	
Break 0.05 mA < I _N < 0.35 mA	
Short-circuit 100 Ω < R _{Sensor} < 360 Ω	
Relay output	
2 PDT	
AgSnO ₂ , hard gold-plated	
250 V AC (2 A, 60 Hz) / 120 V DC (0.2 A) / 30 V DC (2 A)	
500 VA	
5 V / 10 mA	
10 ⁷ cycles	
can be inverted using DIP switch	
20 Hz (Load-dependent)	
24 V ... 230 V AC/DC (-20% ... +10%, 50 ... 60 Hz)	
< 80 mA ; < 42 mA (24 V DC)	
max. 1.3 W	
Input/output	375 V (Peak value in accordance with EN 60079-11)
Input/power supply	375 V (Peak value in accordance with EN 60079-11)
	300 V _{rms} (Rated insulation voltage, surge voltage category II; pollution degree 2, safe isolation as per EN 61010, EN 50178)
	2.5 kV AC (50 Hz, 1 min., test voltage)
Output 1/output 2/input, power supply	300 V _{rms} (Rated insulation voltage, surge voltage category III; pollution degree 2, safe isolation as per EN 61010, EN 50178)
	2.5 kV (50 Hz, 1 min., test voltage)
Ambient temperature range	-20°C ... 60°C
Humidity	10% ... 95% (no condensation)
Housing material	PA 66-FR
Inflammability class according to UL 94	V0
Dimensions W / H / D	17.5 / 99 / 114.5 mm
Screw connection solid / stranded / AWG	0.2 ... 2.5 mm ² / 0.2 ... 2.5 mm ² / 24 - 14
Spring-cage connection (solid/stranded/AWG)	0.2 ... 1.5 mm ² / 0.2 ... 1.5 mm ² / 24 - 16
Safety data as per ATEX	
Maximum voltage U _o	9.6 V
Maximum current I _o	10.3 mA
Maximum power P _o	25 mW
Maximum voltage U _m	253 V AC/DC (Supply terminals)
	250 V AC (Output terminals)
	120 V DC (Output terminals)
Conformance / approvals	
Conformance	
ATEX	
IECEX	
Functional safety (SIL)	
CE-compliant, additionally EN 61326	
II (1) G [Ex ia Ga] IIC	
II (1) D [Ex ia Da] IIIC	
II 3(1) G Ex nA nC [ia Ga] IIC T4 Gc X	
[Ex ia Ga] IIC; [Ex ia Da] IIIC; Ex nA nC [ia Ga] IIC T4 Gc	
SIL 2 according to EN 61508	

Notes:
Information on resistance circuits and marking material can be found on page 183
1) EMC: Class A product, see page 571

Ordering data

Description	Type	Order No.	Pcs. / Pkt.	
NAMUR isolating amplifier , 2-channel, input intrinsically safe, output: Changeover contact	Screw connection	MACX MCR-EX-SL-2NAM-R-UP'	2865984	1
	Spring-cage conn.	MACX MCR-EX-SL-2NAM-R-UP-SP'	2924249	1

Digital IN
NAMUR isolating amplifier, Ex i

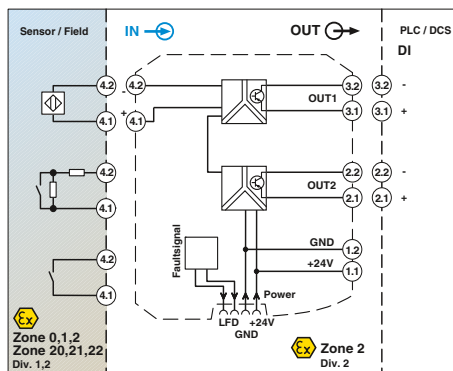
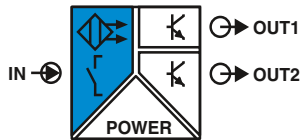

2 signal outputs: transistor (passive)

Functional safety

Ex: Ex i

Housing width 12.5 mm

Technical data

NAMUR isolating amplifier for intrinsically safe operation of proximity sensors and mechanical contacts installed in Ex areas.

- Input for NAMUR proximity sensors (EN 60947-5-6), floating contacts or contacts with resistance circuit, [Ex ia]
- 2 signal outputs: transistor (passive); up to 5 kHz
- Signal output 2 can also be used as a fault signaling output
- Reversible direction of action (operating current or closed-circuit current behavior)
- Line fault detection (LFD), can be activated/deactivated, error message signaled by red flashing LED with inhibiting of transistor output
- Power supply and error indication possible via the DIN rail connector
- LED displays for indicating supply voltage, circuit state, and malfunctions to NAMUR NE 44
- 4-way electrical isolation
- Up to SIL 2 according to EN 61508
- Installation in zone 2 permitted

Input data

Input signal

No-load voltage
Switching points
Line error detection

Switching output

Maximum switching voltage
Maximum switching current
Drop (ΔU)
Switching behavior
Maximum switching frequency

General data

Supply voltage range
Current consumption
Power dissipation
Number of channels
Electrical isolation

Input/output
Input/supply, T-Connector
Input/output/supply, T-Connector

Output 1/output 2

Ambient temperature range
Humidity
Status indication

Housing material
Inflammability class according to UL 94
Dimensions W / H / D
Screw connection solid / stranded / AWG
Spring-cage connection (solid/stranded/AWG)

Safety data as per ATEX

Maximum voltage U_o
Maximum current I_o
Maximum power P_o
Maximum voltage U_m
Conformance / approvals

Conformance
ATEX

IECEX
UL, USA / Canada
Functional safety (SIL)

NAMUR proximity sensors (EN 60947-5-6)
Floating switch contacts
Switch contacts with resistance circuit
8 V DC $\pm 10\%$
> 2.1 mA (conductive) / < 1.2 mA (blocking)
Break 0.05 mA < I_{M1} < 0.35 mA
Short-circuit 100 Ω < R_{Sensor} < 360 Ω
2 transistor outputs, passive
30 V DC (per output)
50 mA (short-circuit resistant)
< 1.4 V
can be inverted using DIP switch
5 kHz

19.2 V DC ... 30 V DC
< 28 mA (24 V DC)
800 mW
1

375 V (Peak value in accordance with EN 60079-11)
375 V (Peak value in accordance with EN 60079-11)
300 V_{rms} (Rated insulation voltage, surge voltage category II; pollution degree 2, safe isolation as per EN 61010, EN 50178)
2.5 kV (50 Hz, 1 min., test voltage)

50 V_{rms} (Rated insulation voltage, surge voltage category II; pollution degree 2, safe isolation as per EN 61010, EN 50178)
1 kV (50 Hz, 1 min., test voltage)

-20°C ... 60°C (Any mounting position)
10% ... 95% (no condensation)
Green LED (supply voltage)
LED yellow (switching state)
Red LED (line errors)

PA 66-FR
V0
12.5 / 99 / 114.5 mm
0.2 ... 2.5 mm² / 0.2 ... 2.5 mm² / 24 - 14
0.2 ... 1.5 mm² / 0.2 ... 1.5 mm² / 24 - 16

9.6 V
10 mA
25 mW
253 V AC (125 V DC)

CE-compliant, additionally EN 61326
 Ex i II (1) G [Ex ia Ga] IIC
 Ex i II (1) D [Ex ia Da] IIIC
 Ex i II 3 G Ex nA IIC T4 Gc X
[Ex ia Ga] IIC; [Ex ia Da] IIIC; Ex nA IIC T4 Gc
Class I Div 2; IS for Class I, II, III Div 1
SIL 2 according to EN 61508

Notes:

Information about the supply and error evaluation module as well as about the DIN rail connectors and marking material can be found from page 182

Information about resistance circuits is given on page 183

Information on "Plug and play" connection using system cabling can be found from page 184

1) EMC: Class A product, see page 571

Ordering data

Description
NAMUR isolating amplifier, input intrinsically safe, output: Transistor, passive
Screw connection
Spring-cage conn.

Type	Order No.	Pcs. / Pkt.
MACX MCR-EX-SL-NAM-2T ¹⁾	2865463	1
MACX MCR-EX-SL-NAM-2T-SP ¹⁾	2924074	1

Digital IN
NAMUR isolating amplifier, Ex i

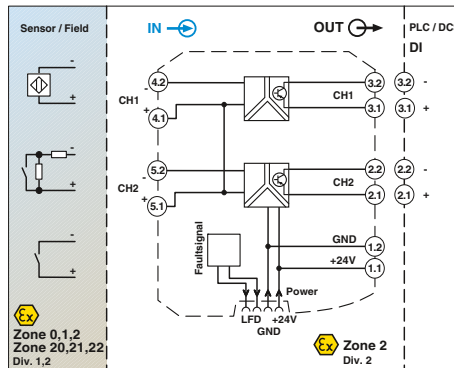
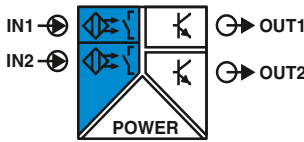

2-channel, signal output transistor (passive)

Functional safety
Ex: Ex i
Housing width 12.5 mm

NAMUR isolating amplifier for intrinsically safe operation of proximity sensors and mechanical contacts installed in Ex areas.

- 2-channel
- Input for NAMUR proximity sensors (EN 60947-5-6), floating contacts or contacts with resistance circuit, [Ex ia]
- Signal output transistor (passive); up to 5 kHz
- Reversible direction of action (operating current or closed-circuit current behavior)
- Line fault detection (LFD), can be activated/deactivated, error message signaled by red flashing LED with inhibiting of transistor output
- Power supply and error indication possible via the DIN rail connector
- LED displays for indicating supply voltage, circuit state, and malfunctions to NAMUR NE 44
- 3-way electrical isolation
- Up to SIL 2 according to EN 61508
- Installation in zone 2 permitted

Input data	Input signal
No-load voltage	
Switching points	
Line error detection	
Switching output	Maximum switching voltage
Maximum switching current	
Drop (ΔU)	
Switching behavior	
Maximum switching frequency	
General data	Supply voltage range
Current consumption	
Power dissipation	
Number of channels	
Electrical isolation	
Ambient temperature range	
Humidity	
Status indication	
Housing material	
Inflammability class according to UL 94	
Dimensions W / H / D	
Screw connection solid / stranded / AWG	
Spring-cage connection (solid/stranded/AWG)	
Safety data as per ATEX	Maximum voltage U_o
Maximum current I_o	
Maximum power P_o	
Maximum voltage U_m	
Conformance / approvals	Conformance
Conformance	
ATEX	
IECEX	
UL, USA / Canada	
Functional safety (SIL)	
Input/output	375 V (Peak value in accordance with EN 60079-11)
Input/supply, T-Connector	375 V (Peak value in accordance with EN 60079-11)
Input/output/supply, T-Connector	300 V _{rms} (Rated insulation voltage, surge voltage category II; pollution degree 2, safe isolation as per EN 61010, EN 50178) 2.5 kV (50 Hz, 1 min., test voltage)
Output 1/output 2	50 V _{rms} (Rated insulation voltage, surge voltage category II; pollution degree 2, safe isolation as per EN 61010, EN 50178) 1 kV (50 Hz, 1 min., test voltage)

Technical data

NAMUR proximity sensors (EN 60947-5-6)
Floating switch contacts
Switch contacts with resistance circuit
8 V DC $\pm 10\%$
> 2.1 mA (conductive) / < 1.2 mA (blocking)
Break 0.05 mA < I_{M1} < 0.35 mA
Short-circuit 100 Ω < R_{Sensor} < 360 Ω
Transistor output, passive
30 V DC (per output)
50 mA (short-circuit resistant)
< 1.4 V
can be inverted using DIP switch
5 kHz

19.2 V DC ... 30 V DC
< 34 mA (24 V DC)
1000 mW
2

Notes:
Information about the supply and error evaluation module as well as about the DIN rail connectors and marking material can be found from page 182
Information about resistance circuits is given on page 183
Information on "Plug and play" connection using system cabling can be found from page 184
1) EMC: Class A product, see page 571

Input/output	375 V (Peak value in accordance with EN 60079-11)
Input/supply, T-Connector	375 V (Peak value in accordance with EN 60079-11)
Input/output/supply, T-Connector	300 V _{rms} (Rated insulation voltage, surge voltage category II; pollution degree 2, safe isolation as per EN 61010, EN 50178) 2.5 kV (50 Hz, 1 min., test voltage)
Output 1/output 2	50 V _{rms} (Rated insulation voltage, surge voltage category II; pollution degree 2, safe isolation as per EN 61010, EN 50178) 1 kV (50 Hz, 1 min., test voltage)
Ambient temperature range	-20°C ... 60°C (Any mounting position)
Humidity	10% ... 95% (no condensation)
Status indication	Green LED (supply voltage) LED yellow (switching state) Red LED (line errors)
Housing material	PA 66-FR
Inflammability class according to UL 94	V0
Dimensions W / H / D	12.5 / 99 / 114.5 mm
Screw connection solid / stranded / AWG	0.2 ... 2.5 mm ² / 0.2 ... 2.5 mm ² / 24 - 14
Spring-cage connection (solid/stranded/AWG)	0.2 ... 1.5 mm ² / 0.2 ... 1.5 mm ² / 24 - 16
Safety data as per ATEX	9.6 V
Maximum voltage U_o	10.3 mA
Maximum current I_o	25 mW
Maximum power P_o	253 V AC (125 V DC)
Maximum voltage U_m	
Conformance / approvals	CE-compliant, additionally EN 61326
Conformance	Ex II (1) G [Ex ia Ga] IIC
ATEX	Ex II (1) D [Ex ia Da] IIIC
	Ex II 3 G Ex nA IIC T4 Gc X
	[Ex ia Ga] IIC; [Ex ia Da] IIIC; Ex nA IIC T4 Gc
	Class I Div 2; IS for Class I, II, III Div 1
	SIL 2 according to EN 61508

Ordering data

Description	Type	Order No.	Pcs. / Pkt.
NAMUR isolating amplifier, 2-channel, input intrinsically safe, output: Transistor, passive	MACX MCR-EX-SL-2NAM-T1)	2865489	1
	Screw connection		
	Spring-cage conn.	MACX MCR-EX-SL-2NAM-T-SP1)	2924090

Digital IN
NAMUR isolating amplifier, Ex i

N

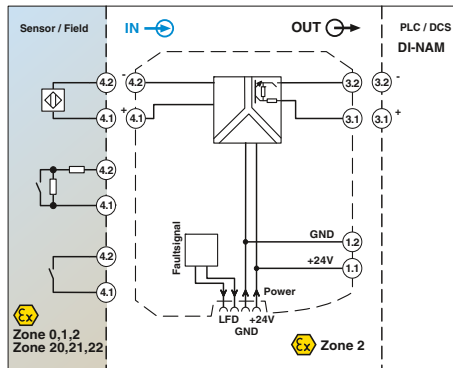
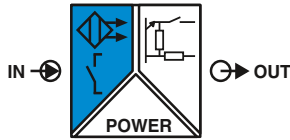

With line fault transparency

NAMUR isolation amplifiers for the intrinsically safe operation of proximity sensors or mechanical contacts installed in the Ex area.

- Input for NAMUR proximity sensors (EN 60947-5-6), floating contacts or contacts with resistance circuit, [Ex ia]
- Signal output with resistive behavior (transistor)
- Signal output with line fault transparency: line error message directly via output to PLC or PCS. The output responds in accordance with EN 60947-5-6.
- Up to 5 kHz
- Direction of operation can be selected
- Line fault detection can be activated/deactivated
- Power supply and error indication possible via the DIN rail connector
- LED indicators for supply voltage, status, and fault according to NAMUR NE 44
- Plug-in screw or spring-cage connection technology
- Safe 3-way electrical isolation
- Up to SIL 2 according to EN 61508
- Installation in zone 2 permissible

Notes:
Information on the supply and error evaluation module, DIN rail connectors, system cabling, and marking material can be found from page 182
Information about resistance circuits is given on page 183

Input data	Input signal
No-load voltage	
Switching points	
Line error detection	
Switching output	Switching voltage
Switching frequency	
Impedance 0-signal	
Impedance 1-signal	
Impedance fault	
Switching behavior	
General data	
Supply voltage range	
Current draw	
Power dissipation	
Electrical isolation	
	Input/output
	Input/supply, T-Connector
	Input/output/supply, T-Connector
Ambient temperature range	
Humidity	
Status indication	
Housing material	
Inflammability class according to UL 94	
Dimensions W / H / D	
Screw connection solid / stranded / AWG	
Spring-cage connection (solid/stranded/AWG)	
Safety data as per ATEX	
Maximum voltage U_o	
Maximum current I_o	
Maximum power P_o	
Maximum voltage U_m	
Conformance / approvals	
Conformance	
ATEX	
IECEX	
Functional safety (SIL)	

Housing width 12.5 mm

Technical data

NAMUR proximity sensors (EN 60947-5-6)
Floating switch contacts
Switch contacts with resistance circuit
8 V DC $\pm 10\%$
> 2.1 mA (conductive) / < 1.2 mA (blocking)
Break 0.05 mA $< I_{M1} < 0.35$ mA
Short-circuit $100 \Omega < R_{Sensor} < 360 \Omega$
Resistive (transistor, passive)
Typ. 8.2 V DC $\pm 10\%$ (according to EN 60947-5-6)
≤ 5 kHz (Ohmic load)
11 k $\Omega \pm 5\%$
1.4 k $\Omega \pm 5\%$
> 100 k Ω
can be inverted using DIP switch
12 V DC ... 24 V DC $-20\% \dots +25\%$
25 mA (24 V DC)
< 0.6 W
375 V (Peak value in accordance with EN 60079-11)
375 V (Peak value in accordance with EN 60079-11)
300 V _{rms} (Rated insulation voltage, surge voltage category II; pollution degree 2, safe isolation as per EN 61010, EN 50178)
2.5 kV (50 Hz, 1 min., test voltage)
$-20^\circ\text{C} \dots 60^\circ\text{C}$ (Any mounting position)
$10\% \dots 95\%$ (no condensation)
Green LED (supply voltage)
LED yellow (switching state)
Red LED (line errors)
PA 66-FR
V0
$12.5 / 99 / 114.5$ mm
$0.2 \dots 2.5$ mm ² / $0.2 \dots 2.5$ mm ² / $24 - 14$
$0.2 \dots 1.5$ mm ² / $0.2 \dots 1.5$ mm ² / $24 - 16$
9.6 V
10 mA
25 mW
253 V AC (125 V DC)
CE-compliant, additionally EN 61326
Ex II (1) G [Ex ia Ga] IIC
Ex II (1) D [Ex ia Da] IIIC
Ex II 3G Ex nA IIC T4 Gc X
Yes
SIL 2

Ordering data

Type	Order No.	Pcs. / Pkt.
MACX MCR-EX-SL-NAM-NAM	2866006	1
MACX MCR-EX-SL-NAM-NAM-SP	2924883	1

Description
NAMUR isolation amplifier , intrinsically safe input, output with line fault transparency
Screw connection
Spring-cage conn.

Digital OUT
Solenoid driver, Ex i

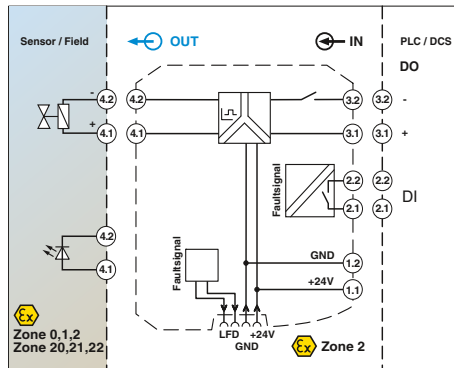
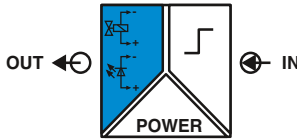

Current limitation 48 mA, with line fault detection

Housing width 12.5 mm

Technical data

Input data	Switching level 0 signal ("L") Switching level 1 signal ("H") Input current Input impedance in the event of a line fault at the output
Output data	Output voltage Current limitation No-load voltage Internal resistance Immunity to short-circuiting Response time t_A Line error detection
Error message output	Switch contact Maximum switching voltage Maximum switching current Short-circuit-proof
General data	Supply voltage range Current draw Power dissipation Electrical isolation
Ambient temperature range	-20°C ... 60°C (Any mounting position)
Humidity	10% ... 95% (no condensation)
Status indication	Green LED (supply voltage) LED yellow (switching state) Red LED (line errors)
Degree of protection	IP20
Housing material	PA 66-FR
Inflammability class according to UL 94	V0
Dimensions W / H / D	12.5 / 99 / 114.5 mm
Screw connection solid / stranded / AWG	0.2 ... 2.5 mm ² / 0.2 ... 2.5 mm ² / 24 - 14
Spring-cage connection (solid/stranded/AWG)	0.2 ... 1.5 mm ² / 0.2 ... 1.5 mm ² / 24 - 16
Safety data as per ATEX	Maximum voltage U_o Maximum current I_o Maximum power P_o Maximum voltage U_m
Conformance / approvals	CE-compliant, additionally EN 61326 Ex II (1) G [Ex ia Ga] IIC Ex II (1) D [Ex ia Da] IIIC Ex II 3(1) G Ex nA [ia Ga] IIC T4 Gc X
IECEx	Yes
Functional safety (SIL)	SIL 3 (applied for)

0 V DC ... 5 V DC (Open)
15 V DC ... 30 V DC
< 12 mA
3 MΩ (High resistance (Mega Ω))

Yes
≥ 9.5 V DC (At 48 mA)
> 48 mA (With cable error detection)
> 23 V DC
≥ 269 Ω (Internal resistance R_i)
Yes
< 30 ms
< 50 Ω (short circuit on the line)
> 10 kΩ (line break)

N/C contact
30 V DC
50 mA
Yes

19.2 V DC ... 30 V DC (24 V DC (-20% ... +25%))
< 90 mA
< 1.5 W

375 V (Peak value in accordance with EN 60079-11)
2.5 kV (50 Hz, 1 min., test voltage)
300 V _{rms} (Rated insulation voltage, surge voltage category II; pollution degree 2, safe isolation as per EN 61010, EN 50178)

Solenoid driver for the intrinsically safe control of Ex i solenoid valves, alarm transmitters or indicators installed in the Ex area.

- Input: logic (low/high signal)
- Output: 48 mA current limitation at 9.5 V, [Ex ia]
- Line fault detection (can be activated/de-activated)
 - Directly via signal channel
 - Or via switching output
- Transparent for test pulses
- Power supply and error indication possible via the DIN rail connector
- LED indicators for supply voltage, status, and fault according to NAMUR NE 44
- Plug-in screw or spring-cage connection technology
- Safe 3-way electrical isolation
- Up to SIL 2 according to EN 61508
- Installation in zone 2 permissible

Notes:

Information on the supply and error evaluation module, DIN rail connectors, system cabling, and marking material can be found from page 182

Description	Solenoid driver , logic input, intrinsically safe output, line fault detection
	Screw connection Spring-cage conn.

Ordering data

Type	Order No.	Pcs. / Pkt.
MACX MCR-EX-SL-SD-23-48-LFD	2924867	1
MACX MCR-EX-SL-SD-23-48-LFD-SP	2924870	1

Digital OUT Solenoid driver, Ex i



Current limitation 25 mA

Solenoid drivers for controlling intrinsically safe solenoid valves, alarm transmitters, and indicators installed in Ex areas.

- 20 ... 30 V DC input
- Output [Ex ia]
- Various output characteristic curves compatible with the commercial solenoid valves
- Loop-powered: The required power is supplied via the control signal on the input side.
- Mechanically compatible with DIN rail connector
- Galvanic 2-way isolation
- Up to SIL 3 as per EN 61508
- Installation in zone 2 permitted

Notes:
A list of suitable valves and notes for calculating a valve circuit are available from the download center at www.phoenixcontact.net/products
Information on marking material can be found on page 127
Information on "Plug and play" connection using system cabling can be found from page 184

Input data	
Input signal	
Input current	
Output data	
Output voltage	
Current limitation	
No-load voltage	
Internal resistance	
Immunity to short-circuiting	
Response time t_A	
General data	
Power dissipation	
Temperature coefficient	
Electrical isolation	
Ambient temperature range	
Humidity	
Status indication	
Degree of protection	
Housing material	
Inflammability class according to UL 94	
Dimensions W / H / D	
Screw connection solid / stranded / AWG	
Spring-cage connection (solid/stranded/AWG)	
Safety data as per ATEX	
Maximum voltage U_o	
Maximum current I_o	
Maximum power P_o	
Maximum voltage U_m	
Conformance / approvals	
Conformance	
ATEX	
IECEX	
UL, USA / Canada	
Functional safety (SIL)	

Functional safety
Ex: Ex i, Ex ia, Ex ia IIC, Ex ia IIC
Housing width 12.5 mm

Technical data	
Input voltage	20 V DC ... 30 V DC
Input current	10 mA DC ... 70 mA DC (45 mA for $U_o = 24$ V DC)
Output voltage	5,5 V DC (At 25 mA)
Current limitation	25 mA
No-load voltage	21.9 V DC
Internal resistance	641 Ω (Internal resistance R_i)
Immunity to short-circuiting	Yes
Response time t_A	20 ms
Power dissipation	< 1 W
Temperature coefficient	0.01%/K
Output/input	375 V (Peak value in accordance with EN 60079-11) 2,5 kV (50 Hz, 1 min., test voltage) 300 V _{rms} (Rated insulation voltage, surge voltage category II; pollution degree 2, safe isolation as per EN 61010, EN 50178) -20°C ... 60°C (Any mounting position) 10% ... 95% (no condensation) Yellow LED (switching state / status, lights up when output circuit is active)
IP20	IP20
PA 66-FR	PA 66-FR
V0	V0
Dimensions W / H / D	12.5 / 99 / 114.5 mm
Screw connection solid / stranded / AWG	0.2 ... 2.5 mm ² / 0.2 ... 2.5 mm ² / 24 - 14
Spring-cage connection (solid/stranded/AWG)	0.2 ... 1.5 mm ² / 0.2 ... 1.5 mm ² / 24 - 16
Maximum voltage U_o	25.1 V
Maximum current I_o	39 mA
Maximum power P_o	245 mW
Maximum voltage U_m	253 V AC (125 V DC)
Conformance / approvals	CE-compliant, additionally EN 61326 Ex i IIC II (1) G [Ex ia Ga] IIC/IIB/IIA Ex ia IIC II (1) D [Ex ia Da] IIC Ex ia IIC II 3 G Ex nA IIC T4 Gc X [Ex ia Ga] IIC; [Ex ia Da] IIC; Ex nA IIC T4 Gc X Class I Div 2; IS for Class I, II, III Div 1 SIL 3

Description
Solenoid driver , loop-powered, output intrinsically safe
Screw connection
Spring-cage conn.

Ordering data		
Type	Order No.	Pcs. / Pkt.
MACX MCR-EX-SL-SD-21-25-LP	2865492	1
MACX MCR-EX-SL-SD-21-25-LP-SP	2924113	1

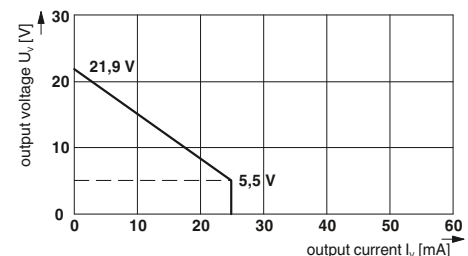

Ex i isolating amplifiers with SIL functional safety - MACX Analog Ex



Current limitation 40 mA

Functional safety
Ex: Ex i, Ex ia, Ex iaD, Ex iaDc
Housing width 12.5 mm



Current limitation 48 mA

Functional safety
Ex: Ex i, Ex ia, Ex iaD, Ex iaDc
Housing width 12.5 mm



Current limitation 58 mA, [Ex ia] IIB

Functional safety
Ex: Ex i, Ex ia, Ex iaD, Ex iaDc
Housing width 12.5 mm

Technical data	
20 V DC ... 30 V DC	10 mA ... 95 mA (65 mA for U ₀ = 24 V DC)
10 V DC (At 40 mA)	40 mA
21.9 V DC	287 Ω (Internal resistance R _i)
Yes	20 ms
< 1.2 W	0.01%/K
375 V (Peak value in accordance with EN 60079-11)	2.5 kV (50 Hz, 1 min., test voltage)
300 V _{rms} (Rated insulation voltage, surge voltage category II; pollution degree 2, safe isolation as per EN 61010, EN 50178)	-20°C ... 60°C (Any mounting position)
10% ... 95% (no condensation)	Yellow LED (switching state / status, lights up when output circuit is active)
IP20	PA 66-FR
V0	12.5 / 99 / 114.5 mm
0.2 ... 2.5 mm ² / 0.2 ... 2.5 mm ² / 24 - 14	0.2 ... 1.5 mm ² / 0.2 ... 1.5 mm ² / 24 - 16
25.1 V	87 mA
550 mW	253 V AC (125 V DC)
CE-compliant, additionally EN 61326	Ex II (1) G [Ex ia Ga] IIC/IIB/IIA
	Ex II (1) D [Ex ia Da] IIIC
	Ex II 3 G Ex nA IIC T4 Gc X
	[Ex ia Ga] IIC; [Ex ia Da] IIIC; Ex nA IIC T4 Gc X
	Class I Div 2; IS for Class I, II, III Div 1
	SIL 3

Technical data	
20 V DC ... 30 V DC	10 mA ... 95 mA (75 mA for U ₀ = 24 V DC)
10.5 V DC (At 48 mA)	48 mA
24 V DC	276 Ω (Internal resistance R _i)
Yes	30 ms
< 1.4 W	0.01%/K
375 V (Peak value in accordance with EN 60079-11)	2.5 kV (50 Hz, 1 min., test voltage)
300 V _{rms} (Rated insulation voltage, surge voltage category II; pollution degree 2, safe isolation as per EN 61010, EN 50178)	-20°C ... 60°C (Any mounting position)
10% ... 95% (no condensation)	Yellow LED (switching state / status, lights up when output circuit is active)
IP20	PA 66-FR
V0	12.5 / 99 / 114.5 mm
0.2 ... 2.5 mm ² / 0.2 ... 2.5 mm ² / 24 - 14	0.2 ... 1.5 mm ² / 0.2 ... 1.5 mm ² / 24 - 16
27.7 V	101 mA
697 mW	253 V AC (125 V DC)
CE-compliant, additionally EN 61326	Ex II (1) G [Ex ia Ga] IIC/IIB/IIA
	Ex II (1) D [Ex ia Da] IIIC
	Ex II 3 G Ex nA IIC T4 Gc X
	[Ex ia Ga] IIC; [Ex ia Da] IIIC; Ex nA IIC T4 Gc X
	Class I Div 2; IS for Class I, II, III Div 1
	SIL 3

Technical data	
20 V DC ... 30 V DC	10 mA ... 105 mA (95 mA for U ₀ = 24 V DC)
12.9 V DC (At 58 mA)	58 mA
21.9 V DC	133 Ω (Internal resistance R _i)
Yes	30 ms
< 1.4 W	0.01%/K
375 V (Peak value in accordance with EN 60079-11)	2.5 kV (50 Hz, 1 min., test voltage)
300 V _{rms} (Rated insulation voltage, surge voltage category II; pollution degree 2, safe isolation as per EN 61010, EN 50178)	-20°C ... 60°C (Any mounting position)
10% ... 95% (no condensation)	Yellow LED (switching state / status, lights up when output circuit is active)
IP20	PA 66-FR
V0	12.5 / 99 / 114.5 mm
0.2 ... 2.5 mm ² / 0.2 ... 2.5 mm ² / 24 - 14	0.2 ... 1.5 mm ² / 0.2 ... 1.5 mm ² / 24 - 16
25.1 V	188 mA
1.18 W	253 V AC (125 V DC)
CE-compliant, additionally EN 61326	Ex II (1) G [Ex ia Ga] IIB/IIA
	Ex II (1) D [Ex ia Da] IIIC
	Ex II 3 G Ex nA IIC T4 Gc X
	[Ex ia Ga] IIB; [Ex ia Da] IIIC; Ex nA IIC T4 Gc X
	Class I Div 2; IS for Class I, II, III Div 1
	SIL 3

Ordering data		
Type	Order No.	Pcs. / Pkt.
MACX MCR-EX-SL-SD-21-40-LP	2865764	1
MACX MCR-EX-SL-SD-21-40-LP-SP	2924139	1

Ordering data		
Type	Order No.	Pcs. / Pkt.
MACX MCR-EX-SL-SD-24-48-LP	2865609	1
MACX MCR-EX-SL-SD-24-48-LP-SP	2924126	1

Ordering data		
Type	Order No.	Pcs. / Pkt.
MACX MCR-EX-SL-SD-21-60-LP	2865515	1
MACX MCR-EX-SL-SD-21-60-LP-SP	2924100	1

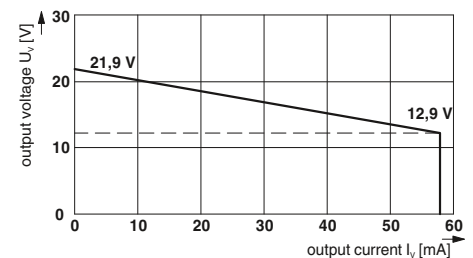
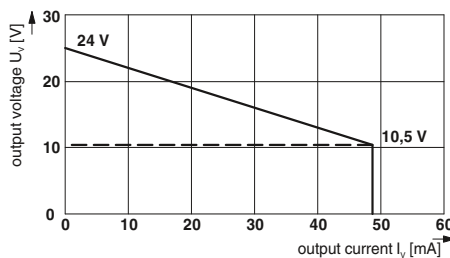
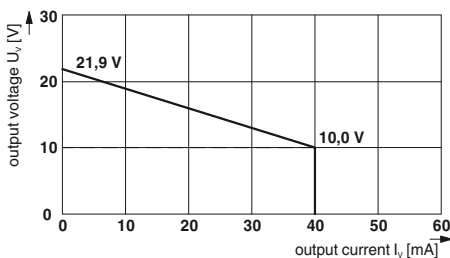

Accessories

Power and error message module

Power and error message module for feeding the 24 V supply voltage to the DIN rail connectors and signaling line faults and power supply failures.

- One-time or redundant supply, decoupled from diode, protected against polarization
- Supply current up to 3.75 A
- Relay output (PDT) and flashing LED for error messages
- Error message in the event of a power supply failure or fuse fault
- Bus cable fault message for MACX MCR-...(2)NAM... devices connected via DIN rail connectors
- Replaceable fuse
- Installation in zone 2 permissible

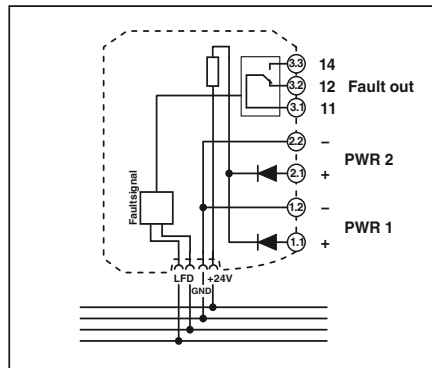

Power and error message module

UL, CE, RoHS
 Ex: Ex n // Applied for: cUL / UL
 Housing width 17.5 mm

Technical data

Input data	
Input signal	
Redundant supply	
Polarization and surge protection	
Output data	
Maximum output signal	
Output voltage	
Switching output	
Contact type	
Contact material	
Maximum switching voltage	
General data	
Current consumption	
Ambient temperature range	
Humidity	
Fuse	
Status indication	
Housing material	
Inflammability class according to UL 94	
Dimensions W / H / D	
Screw connection solid / stranded / AWG	
Spring-cage connection (solid/stranded/AWG)	
Conformance / approvals	
Conformance	
ATEX	
IECEX	
UL, USA / Canada	

19.2 V DC ... 30 V DC
yes, decoupled from diodes
Yes
3.75 A
(Input voltage - max. 0.8 V at 3.75 A)
Relay
1 PDT
Gold (Au)
50 V AC (2 A)
-20°C ... 60°C (Any mounting position)
5% ... 95% (no condensation)
5 A (replaceable), slow-blow 250 V AC
1 x red LED (error)
2 x green LEDs (PWR1 and PWR2)
Polyamide (PA 6.6)
V0
17.5 / 99 / 114.5 mm
0.2 ... 2.5 mm ² / 0.2 ... 2.5 mm ² / 24 - 14
0.2 ... 1.5 mm ² / 0.2 ... 1.5 mm ² / 24 - 16

CE-compliant
Ex II 3 G Ex nA nC IIC T4 Gc X
Ex nA nC IIC T4 Gc X
UL 61010

Ordering data

Type	Order No.	Pcs. / Pkt.
MACX MCR-PTB	2865625	1
MACX MCR-PTB-SP	2924184	1

Accessories

ME 6,2 TBUS-2 1,5/5-ST-3,81 GN	2869728	10
--------------------------------	---------	----

ME 6,2 TBUS... T-Connector

DIN rail connector (5-pos.) for bridging the supply voltage of 12.5 mm wide MACX analog Ex modules.

- Reduces wiring costs
- System can be extended or module replaced even while process is active
- Inter-extendable

Description	
Supply and error message module, including the relevant DIN rail connector ME 17,5 TBUS 1,5/5-ST-3,81 GN	
Screw connection	MACX MCR-PTB
Spring-cage conn.	MACX MCR-PTB-SP
DIN rail connector (TBUS) , for bridging the supply voltage, can be snapped onto 35 mm DIN rails as per EN 60715, with UL approval	

Accessories

Marking material for device marking

- For device marking inside the control cabinet and in the field
- Self-adhesive with high adhesive strengths
- Large temperature range



		Ordering data		
Description	Color	Type	Order No.	Pcs. / Pkt.
UniCard, with self-adhesive plastic labels				
10-part, lettering field size: 11 x 9 mm	white	UC-EMLP (11X9)	0819291	10
UniCard, with self-adhesive plastic labels, marked according to customer specifications For ordering details, see Catalog 5 or www.phoenixcontact.net/products				
10-part, lettering field size: 11 x 9 mm	white	UC-EMLP (11X9) CUS	0824547	1

Accessories

Resistance circuit

Double-level terminal block with resistance circuit according to NAMUR for line fault detection in the case of mechanical contacts

Important:

- For intrinsically safe circuits, only in combination with D-UKK 3/5 cover



		Ordering data		
Description	Color	Type	Order No.	Pcs. / Pkt.
Double-level terminal block, with preassembled resistors				
With screw connection		UKK 5-2R/NAMUR	2941662	50
Cover, width 2.5 mm				
	gray	D-UKK 3/5	2770024	50
	blue	D-UKK 3/5 BU	2770105	50

Termination carrier for MACX Analog Ex-isolating amplifiers



Select standard DIN rail device



Select module carrier

TC... termination carriers are compact solutions for quickly and smoothly connecting DIN rail devices from the MACX Analog Ex series to input/output cards of automation systems using system cables.

The termination carriers combine the advantages of modular DIN rail devices with those offered by plug and play rapid cabling solutions to provide a consistent solution for system technology.

Compact

- Saves up to 30% of space due to compact design

Robust and reliable

- Stable, vibration-resistant aluminum carrier device profile
- PCB is completely decoupled from modules
- PCB without active components
- Redundant supply and monitoring in separate DIN rail module

Easy maintenance

- Use of standard DIN rail devices
- Easy access to connection points
- Quick and safe module connection with plug-in and coded cable sets

Flexible

- Horizontal or vertical DIN rail mounting
- Profile section without pitch markings for I/O cards with specific number of channels
- Can be specifically adapted for I/O cards of various automation systems with different system plug types



Select controller-specific front adapter and system cable



Solutions are also available for MINI Analog, MACX Analog Ex, and Safety

Termination carrier for MACX Analog Ex-isolating amplifiers

The **TC-D37SUB-ADIO16-EX-P-UNI** universal termination carrier is a compact solution which connects isolating amplifiers from the MACX Analog Ex series to analog or binary input/output cards of automation systems.

The **TC-D37SUB-AIO16-EX-PS-UNI** termination carrier design, when combined with the MACX MCR-S-MUX HART multiplexer, also enables communication between HART-capable field devices and a management system.

- Connection of up to 16 single-channel (Ex i)-isolating amplifiers
- Universal 1:1 signal routing to a 37-pos. D-SUB plug-in connector
- For system cables with D-SUB socket and open ends for universal connection
- Redundant supply and monitoring in separate DIN rail module

Notes:
Contact us: specific termination carrier designs for I/O modules of various automation systems are available, planned or can be implemented according to your specifications.
1) EMC: Class A product, see page 571



Housing width 244 mm

General data	
Connection to the control system level	
Number of positions	
Maximum operating voltage	
Maximum permissible current	
Rated insulation voltage	
Surge voltage category	
Pollution degree	
Rated surge voltage	
Air and creepage distances	
Degree of protection	
Ambient temperature range	
Shock	
Vibration (operation)	
Inflammability class according to UL 94	
Dimensions W / H / D	
Power supply via power module	
Input voltage range	
Redundant supply	
Polarization and surge protection	
Fuse	
Status indication	
Switching output	
Contact material	
Maximum switching voltage	

Technical data	
D-SUB pin strip	
37	
< 50 V DC (Per signal/channel)	
1 A (Signal/channel)	
50 V	
II	
2	
0.5 kV	
DIN EN 50178 (Basic insulation)	
IP20	
-40°C ... 80°C (Please observe module specifications)	
15g, according to IEC 60068-2-27	
2g, according to IEC 60068-2-6	
V0	
244 / 170 / 160 mm	
Power supply via power module	
19.2 V DC ... 30 V DC	
yes, decoupled from diodes	
Yes	
5 A Slow-blow (can be exchanged)	
1 x red LED (error)	
2 x green LEDs (PWR1 and PWR2)	
1 PDT	
Au	
50 V DC (0.3 A) / 30 V DC (2 A) / 33 V AC (2 A)	

Description	
Universal termination carrier for 16 MACX MCR-EX isolators	
- With connection for MACX MCR-S-MUX HART multiplexer	

Ordering data		
Type	Order No.	Pcs. / Pkt.
TC-D37SUB-ADIO16-EX-P-UNI	2924854	1
TC-D37SUB-AIO16-EX-PS-UNI¹⁾	2902932	1

Supply and error message module	
HART multiplexer, 32-channel	

Accessories		
MACX MCR-PTB	2865625	1
MACX MCR-PTB-SP	2924184	1
MACX MCR-S-MUX	2865599	1

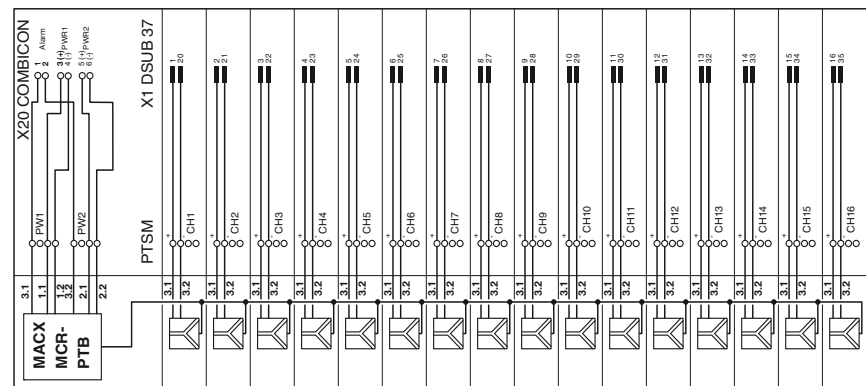

TC-D37SUB-ADIO16-EX-P-UNI and TC-D37SUB-AIO16-EX-PS-UNI connection scheme

Multiplexers for HART signals

Multiplexers for HART signals

Multiplexer for digital connection of HART-capable field devices (such as measuring transducers or control valves) to a PC or management system.

- Supports online configuration and diagnostics for the connected HART-capable field devices
- Constant documentation of process variables and states
- 32 HART channels per multiplexer
- Up to 128 HART multiplexers at one PC interface
- Communication via software tool (e.g., HART OPC Server) using RS-485 interface
- Electrical isolation between auxiliary energy, RS-485 bus and the HART channels
- HART field devices are accessed at the same time that the measurement signal is transmitted without affecting measured value processing
- HART field devices connected via universal HART connection boards; direct connection if processing non-Ex signals, with separate Ex i signal isolator connected upstream if processing Ex signals
- Power supplied via HART connection board

Notes:
1) EMC: Class A product, see page 571

Field devices interface (HART)	
Channels	16 or 32; adjustable using a switch
Connection method	Flat-ribbon cable, 14-pos. (inclusive)
Signal	HART FSK
HART specification	HART Field Communication Protocol Rev. 6.0 (downward compatible up to Rev 4.0); FSK Physical Layer Specification (Rev. 8.1)
Data transmission display	
Display error	Two yellow "Tx" and "Rx" "HART" LEDs Red "ERR" LED (flashes in case of an error in the HART bus)
RS-485 interface	
Connection method	D-SUB-9 socket
Signal	RS-485
Data flow control/protocols	Compatible with OPC HART server, PDM, PRM, and FDT/DTM
Number of HART multiplexers per bus segment	
Address setting	Max. 31
Data rate	0...127; using a rotary switch at the front 9600 / 19200 / 38400 / 57600 [bps]; via rotary switch at the front
Transmission length	
Display	≤ 1200 m Two yellow "Tx" and "Rx" "RS-485" LEDs
General data	
Supply voltage range	18 V ... 31.2 V
Nominal supply voltage	24 V DC
Current consumption	55 mA
Power consumption	1.35 W
Operating voltage display	Green "PWR" LED
Undervoltage monitoring	Yes (no faulty devices / output states)
Galvanic isolation of HART signal/RS-485	
Galvanic isolation of HART signals between each other	350 V AC
Galvanic isolation of HART signal/supply	100 V DC (Capacitive)
Galvanic isolation of RS-485/supply	350 V AC
Error monitoring	350 V AC Processor error: The "PWR" LED flashes; error in the HART communication: the "ERR" LED flashes
Ambient temperature range	
Humidity	-20°C ... 60°C
Dimensions W / H / D	≤ 95% (no condensation)
Conformance / approvals	35.2 / 99 / 114.5 mm
Conformance	CE-compliant

Description
HART multiplexer , 32-channel including two 14-wire flat-ribbon cables
Universal termination carrier for 16 MACX MCR-EX isolators - With connection for MACX MCR-S-MUX HART multiplexer
Universal termination carrier for 16 MINI MCR isolators - With connection for MACX MCR-S-MUX HART multiplexer
HART connection board Interface converter , for conversion from RS-232 (V.24) to RS-485, with electrical isolation, rail-mountable, changeover of data direction self-controlling or through RTS/CTS
Repeater , for electrical isolation and increased range

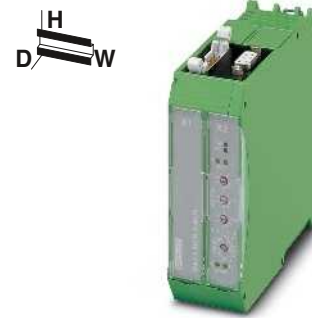

Housing width 35.2 mm

Technical data		
16 or 32; adjustable using a switch		
Flat-ribbon cable, 14-pos. (inclusive)		
HART FSK		
HART Field Communication Protocol Rev. 6.0 (downward compatible up to Rev 4.0); FSK Physical Layer Specification (Rev. 8.1)		
Two yellow "Tx" and "Rx" "HART" LEDs		
Red "ERR" LED (flashes in case of an error in the HART bus)		
D-SUB-9 socket		
RS-485		
Compatible with OPC HART server, PDM, PRM, and FDT/DTM		
Max. 31		
0...127; using a rotary switch at the front		
9600 / 19200 / 38400 / 57600 [bps]; via rotary switch at the front		
≤ 1200 m		
Two yellow "Tx" and "Rx" "RS-485" LEDs		
18 V ... 31.2 V		
24 V DC		
55 mA		
1.35 W		
Green "PWR" LED		
Yes (no faulty devices / output states)		
350 V AC		
100 V DC (Capacitive)		
350 V AC		
350 V AC		
Processor error: The "PWR" LED flashes; error in the HART communication: the "ERR" LED flashes		
-20°C ... 60°C		
≤ 95% (no condensation)		
35.2 / 99 / 114.5 mm		
CE-compliant		

Ordering data		
Type	Order No.	Pcs. / Pkt.
MACX MCR-S-MUX	2865599	1

Accessories		
Type	Order No.	Pcs. / Pkt.
TC-D37SUB-AIO16-EX-PS-UNI ¹⁾	2902932	1
TC-D37SUB-AIO16-M-PS-UNI ¹⁾	2902934	1
MACX MCR-S-MUX-TB	2308124	1
PSM-ME-RS232/RS485-P ¹⁾	2744416	1
PSM-ME-RS485/RS485-P ¹⁾	2744429	1

Programmable loop-powered temperature measuring transducer, Ex i

- 1-channel
- Loop-powered
- Input for resistance thermometers, thermocouples, and linear mV signals, Ex ia IIC
- Output 4...20 mA/20...4 mA
- Can be installed in zone 1
- Galvanic 2-way isolation
- HART-capable (MCR-FL-TS-LP-I-EX)
- Configuration using software

Notes:
The devices are supplied with the standard configuration: Pt 100 sensor, measuring range 0 ... 100°C, 3-cond. connection.
To configure the MCR-FL-TS-LPI-EX HART-capable device (2864587), you need a HART modem.
To configure the MCR-FL-T-LP-EX device (2864574), you need the MCR-PAC-T-USB programming adapter and the MCR/PI-CONF-WIN software, see page 190

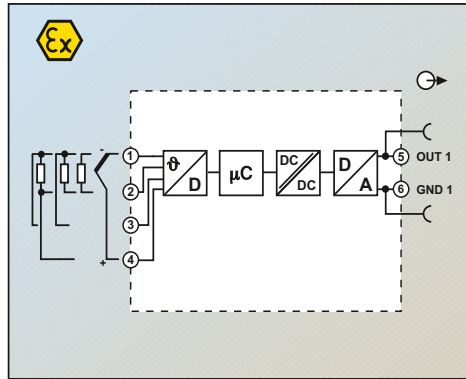

Block diagram MCR-FL-TS-LP-I-EX



Loop-powered, programmable

Ex: Ex i, Ex ia
Housing width 12.5 mm

Technical data

Measuring input	Resistance thermometers Thermocouple sensors	
Resistor		10 Ω ... 400 Ω (min. measurement range 10 Ω) 10 Ω ... 2000 Ω (min. measurement range 100 Ω) -10 mV ... 100 mV (min. measurement range 5 mV) Yes, programmable
Voltage		
Configuration		
Measuring output		
Output signal range		4 mA ... 20 mA / 20 mA ... 4 mA
Maximum output signal		≤ 23 mA
Load		≤ 520 Ω (At U _V = 24 V; U _{supply} - 12 V / 0.023 A)
Line monitoring		NE 43
Short-circuit current		≤ 3.6 mA or ≥ 21 mA (adjustable, not for thermocouples)
Output current with open circuit		≤ 3.6 mA or ≥ 21 mA (adjustable)
Output current, measuring range overrange/underrange		3.8 mA ... 20.5 mA
General data		
Supply voltage range		12 V DC ... 30 V DC
Current consumption		< 3.5 mA
Step response (10 - 90%)		< 2 s
Transmission error	Resistance thermometers Thermocouple sensors Resistance-type sensors Voltage sensor	0.2 K (Pt 100, Ni 100), 0.5 K (Pt 500, Ni 500), 0.3 K (Pt 1000, Ni 1000) Type 0.5 K (K, J, T, E, L, U), 1.0 K (N, C, D), 2.0 K (S, B, R) ±0.1 Ω (10...400 Ω), ±1.5 Ω (10...2000 Ω) ±20 µV (-10...100 mV) 2 kV AC (50 Hz, 1 min.) 4 s NAMUR recommendation NE 21
Test voltage input/output		Polyamide PA non-reinforced V0
Switch on delay time		12.5 / 99 / 114.5 mm
Standards/regulations		Plug-in screw connection
Housing material		0.2 ... 2.5 mm ² / 0.2 ... 2.5 mm ² / 24 - 14
Inflammability class according to UL 94		
Dimensions W / H / D		
Connection method		
Screw connection solid / stranded / AWG		
Safety data as per ATEX		
Maximum voltage U_i		MCR-FL-TS-LP-I-EX MCR-FL-T-LP-I-EX
Maximum current I_i		30 V 30 V
Maximum power P_i		100 mA 100 mA
Maximum voltage U_o		750 mW 750 mW
Maximum current I_o		5 V DC 4.4 V DC
Maximum power P_o		5.9 mA 9.6 mA
Gas group		7.2 mW 10.6 mW
- max. external inductivity L_o	[mH]	II A II B II C II A II B II C
- max. external capacity C_o	[µF]	100 100 100 100 100 100
Maximum ambient temperature		10 10 2 12 12 2.4
		T4 = 85°C, T5 = 70°C, T6 = 55°C T4 = 85°C, T5 = 65°C, T6 = 50°C
Conformance / approvals		
Conformance		CE-compliant
ATEX		Ex i 2(1) G Ex ia IIC T6
UL, USA / Canada		CE-compliant
Functional safety (SIL)		Ex i 2(1) G Ex ia IIC T4...T6
		cULus
		SIL 2 according to EN 61508
		cULus
Description		
MCR temperature transducer , for resistance thermometers, thermocouples, resistance-type sensors, and voltage sensors		
HART-compatible		

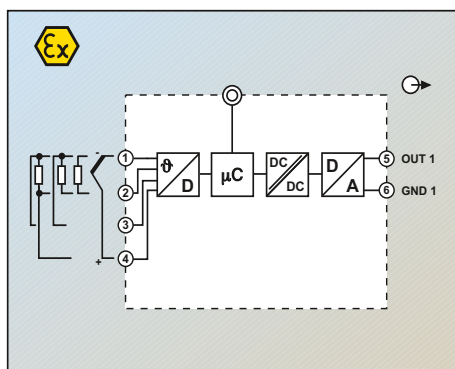

Block diagram MCR-FL-T-LP-I-EX

Ordering data

Type	Order No.	Pcs. / Pkt.
MCR-FL-TS-LP-I-EX	2864587	1
MCR-FL-T-LP-I-EX	2864574	1

Ex i 2-conductor field devices

Programmable loop-powered temperature measuring transducers with connection heads, Ex i

- 1-channel
- Loop-powered
- Input for resistance thermometers, thermocouples, and linear mV signals, Ex ia IIC
- Output 4...20 mA/20...4 mA
- Can be installed in zone 0
- Galvanic 2-way isolation
- HART-compatible

Notes:
 The devices are supplied with the standard configuration: Pt 100 sensor, measuring range 0 ... 100°C, 3-conductor connection.
 To configure the MCR-FL-TS-LPI-EX HART-capable device, you need a HART modem.

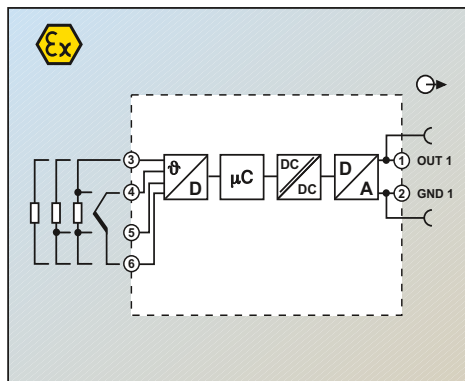

Block diagram MCR-FL-HT-TS-I-EX



Loop-powered, programmable

PC
 Ex: Ex i U₁

Measuring input

Resistance thermometers
 Thermocouple sensors

Resistor

Voltage
 Configuration

Measuring output

Output signal range
 Maximum output signal
 Load
 Line monitoring
 Short-circuit current

Output current with open circuit
 Output current, measuring range overrange/underrange

General data

Supply voltage range
 Current consumption
 Step response (10 - 90%)
 Transmission error

Resistance thermometers
 Thermocouple sensors
 Resistance-type sensors
 Voltage sensor

Test voltage input/output

Switch on delay time
 Degree of protection
 Mounting position
 Connection
 Standards/regulations
 Housing material
 Inflammability class according to UL 94
 Screw connection solid / stranded / AWG

Safety data as per ATEX

Maximum voltage U_i
 Maximum current I_i
 Maximum power P_i
 Maximum voltage U_o
 Maximum current I_o
 Maximum power P_o
 Gas group
 - max. external inductivity L_o [mH]
 - max. external capacity C_o [µF]
 Maximum ambient temperature

Technical data

Pt, Ni (100, 500, 1000); min. measurement range 10 K
 B, C, D, E, J, K, L, N, R, S, T, U; min. measurement range 50 K/500 K

10 Ω ... 400 Ω (min. measurement range 10 Ω)
 10 Ω ... 2000 Ω (min. measurement range 100 Ω)
 -10 mV ... 75 mV (min. measurement range 5 mV)
 Yes, programmable

4 mA ... 20 mA / 20 mA ... 4 mA
 ≤ 23 mA
 ≤ 630 Ω (At $U_V = 24$ V; $U_{supply} - 10$ V / 0.023 A)
 NE 43
 ≤ 3.6 mA or ≥ 21 mA (adjustable, not for thermocouples)

≤ 3.6 mA or ≥ 21 mA (adjustable)
 3.8 mA ... 20.5 mA (linear increase/decrease)

12 V DC ... 30 V DC
 < 3.5 mA
 < 2 s

0.2 K (Pt 100, Ni 100), 0.5 K (Pt 500, Ni 500), 0.3 K (Pt 1000, Ni 1000)
 Type 0.5 K (K, J, T, E, L, U), 1.0 K (N, C, D), 2.0 K (S, B, R)
 ±0.1 Ω (10...400 Ω), ±1.5 Ω (10...2000 Ω)
 ±20 µV (-10...75 mV)

2 kV AC (50 Hz, 1 min.)
 6 s
 IP00, IP66 (integrated in the connecting head)
 Connecting head according to DIN 43729 form B
 Installation in connection head according to DIN 43729 form B
 NAMUR recommendation NE 21
 Polycarbonate, PC
 V0
 0.2 ... 1.75 mm² / 0.2 ... 1.75 mm² / 24 - 15

30 V
 100 mA
 750 mW
 5 V DC
 5.4 mA
 6.6 mW
 II A II B II C
 100 100 100
 9.9 9.9 2
 Category 1: T4 = 60°C, T5 = 50°C, T6 = 40°C
 Category 2: T4 = 85°C, T5 = 70°C, T6 = 55°C

Conformance / approvals

Conformance
 ATEX
 UL, USA / Canada
 Functional safety (SIL)

CE-compliant
 Ex i II 1 G and II 2 G Ex ia IIC T6/T5/T4
 cULus
 SIL 2 according to EN 61508

Description

MCR temperature measuring transducer, smart, for resistance thermometers, thermocouples, resistance-type sensors, and voltage sensors

Ordering data

Type	Order No.	Pcs. / Pkt.
MCR-FL-HT-TS-I-EX	2864545	1

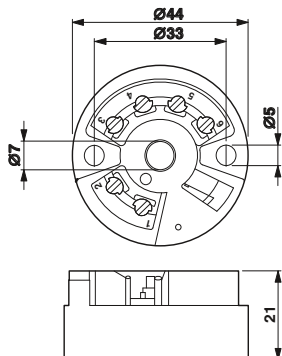

Programmable loop-powered temperature measuring transducers with connection heads, Ex i

- 1-channel
- Loop-powered
- Input for resistance thermometers, thermocouples, and linear mV signals, Ex ia IIC
- Output 4...20 mA/20...4 mA
- Can be installed in zone 0
- Galvanic 2-way isolation
- Configuration using software

Notes:
 The devices are supplied with the standard configuration: Pt 100 sensor, measuring range 0 ... 100°C, 3-cond. connection.
 You can implement your own measuring range settings, linearization, and characteristic curve adjustments. For this purpose, you need the MCR-PAC-T-USB programming adapter and the MCR/PI-CONF-WIN configuration software, see page 190

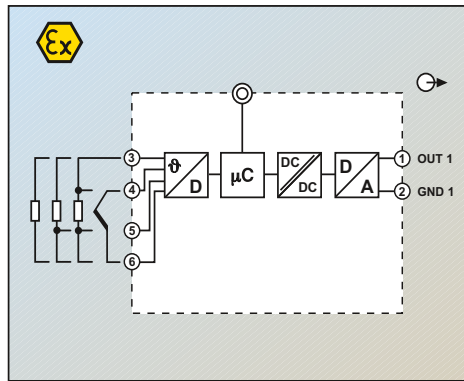

Block diagram MCR-FL-HT-T-I-EX



Loop-powered, programmable



Measuring input

Resistance thermometers
 Thermocouple sensors

Resistor

Voltage
 Configuration

Measuring output

Output signal range
 Maximum output signal
 Load
 Line monitoring
 Short-circuit current

Output current with open circuit
 Output current, measuring range overrange/underrange

General data

Supply voltage range
 Current consumption
 Step response (10 - 90%)
 Transmission error

Resistance thermometers
 Thermocouple sensors
 Resistance-type sensors
 Voltage sensor

Test voltage input/output

Switch on delay time
 Degree of protection
 Mounting position
 Connection
 Standards/regulations
 Housing material
 Inflammability class according to UL 94
 Screw connection solid / stranded / AWG

Safety data as per ATEX

Maximum voltage U_i
 Maximum current I_i
 Maximum power P_i
 Maximum voltage U_o
 Maximum current I_o
 Maximum power P_o
 Gas group
 - max. external inductivity L_o
 - max. external capacity C_o
 Maximum ambient temperature

Pt, Ni (100, 500, 1000); min. measurement range 10 K
 B, C, D, E, J, K, L, N, R, S, T, U; min. measurement range 50 K/500 K

10 Ω ... 400 Ω (min. measurement range 10 Ω)
 10 Ω ... 2000 Ω (min. measurement range 100 Ω)
 -10 mV ... 100 mV (min. measurement range 5 mV)
 Yes, programmable

4 mA ... 20 mA / 20 mA ... 4 mA
 ≤ 25 mA
 $\leq 720 \Omega$ (For $U_v = 24$ V; $U_{supply} = 8$ V / 0.025 A)
 NE 43
 ≤ 3.6 mA or ≥ 21 mA (adjustable, not for thermocouples)

≤ 3.6 mA or ≥ 21 mA (adjustable)
 3.8 mA ... 20.5 mA (linear increase/decrease)

8 V DC ... 30 V DC
 < 3.5 mA
 < 2 s

0.2 K (Pt 100, Ni 100), 0.5 K (Pt 500, Ni 500), 0.3 K (Pt 1000, Ni 1000)
 Type 0.5 K (K, J, T, E, L, U), 1.0 K (N, C, D), 2.0 K (S, B, R)
 $\pm 0.1 \Omega$ (10...400 Ω), $\pm 1.5 \Omega$ (10...2000 Ω)
 $\pm 20 \mu V$ (-10...100 mV)
 2 kV AC (50 Hz, 1 min.)

6 s
 IP00, IP66 (integrated in the connecting head)
 Connecting head according to DIN 43729 form B
 Installation in connection head according to DIN 43729 form B
 NAMUR recommendation NE 21
 Polycarbonate, PC
 V0
 0.2 ... 1.75 mm² / 0.2 ... 1.75 mm² / 24 - 15

30 V
 100 mA
 750 mW
 8.2 V DC
 4.6 mA
 9.35 mW
 II B II C
 8.5 4.5 [mH]
 1.9 0.974 [μF]

Category 1: T4 = 60°C, T5 = 50°C, T6 = 40°C
 Category 2: T4 = 85°C, T5 = 70°C, T6 = 55°C

Conformance / approvals

Conformance
 ATEX
 UL, USA / Canada

CE-compliant
 Ex II 1 G Ex ia IIC T6/T5/T4
 cULus

Description

MCR temperature measuring transducer, for resistance thermometers, thermocouples, resistance-type sensors, and voltage sensors

Ordering data

Type	Order No.	Pcs. / Pkt.
MCR-FL-HT-T-I-EX	2864532	1

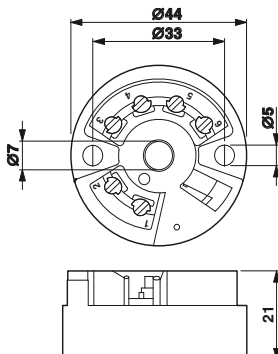

Accessories

Configuration software package

The **MCR/PI-CONF-WIN configuration software package** is used to configure and visualize all parameters for the programmable loop-powered temperature transducers.

- For temperature transducers
MCR-FL-T(S)-LP-I-EX and
MCR-FL-HT-T(S)-I-EX
- Galvanically isolated
- Configuration possible during operation
- Straightforward menu interface
- Rapid programming

The computer and the measuring transducer communicate with one another via a software adapter cable and a serial interface.

Notes:
The software runs under the following operating systems:
Windows NT™, 2000™, and XP™.



Description
MCR configuration software , for programming MCR-T-..., MCR-...-LP-..., MCR-...-HT-..., MCR-S-..., MCR-F-..., and MCR-PSP-... modules, CD-ROM

Ordering data		
Type	Order No.	Pcs. / Pkt.
MCR/PI-CONF-WIN	2814799	1

Accessories

USB adapter cable

Software adapter cable

For connecting the programmable MCR-/PI modules to the USB interface of a computer, the USB adapter cable **CM-KBL-RS232/USB** can be used together with the relevant adapter cables. Programming with the MCR/PI-CONF-WIN software is possible under the operating systems Windows 98™, Windows 2000™ and Windows XP™.

The following modules are supported:

- MCR-FL-T-LP-I-EX
- MCR-FL-HT-T-I-EX



Description
USB adapter cable , D-9-SUB to USB, with adapter D-9-SUB to D-25-SUB
Software adapter cable , 2.4 m length, with USB connection, for programming MCR-...-LP-... and MCR-...-HT-... modules

Ordering data		
Type	Order No.	Pcs. / Pkt.
CM-KBL-RS232/USB	2881078	1
MCR-PAC-T-USB	2309000	1

Adapter cable , stranded, 9-pos. D-SUB socket on 25-pos. D-SUB pin

Accessories		
Type	Order No.	Pcs. / Pkt.
PSM-KAD 9 SUB 25/BS	2761295	1

Accessories

Shield fast connection

- For connecting cable shielding to cable terminal points
- Can be connected to PLUGTRAB PT
- Easy assembly



Description	Ordering data		
	Type	Order No.	Pcs. / Pkt.
Shield fast connection For Ø 3-6 mm For Ø 5-10 mm	SSA 3-6	2839295	10
	SSA 5-10	2839512	10

Accessories

Test plug

Description	Color	Ordering data		
		Type	Order No.	Pcs. / Pkt.
Test plug , consisting of:		MPS-MT	0201744	10
Metal part for 2.3 mm Ø socket hole and		MPS-IH RD	0201676	10
Insulating sleeve , for MPS metal part	red	MPS-IH WH	0201663	10
	white	MPS-IH BU	0201689	10
	blue	MPS-IH YE	0201692	10
	yellow	MPS-IH GN	0201702	10
	green	MPS-IH GY	0201728	10
	gray	MPS-IH BK	0201731	10
	black			

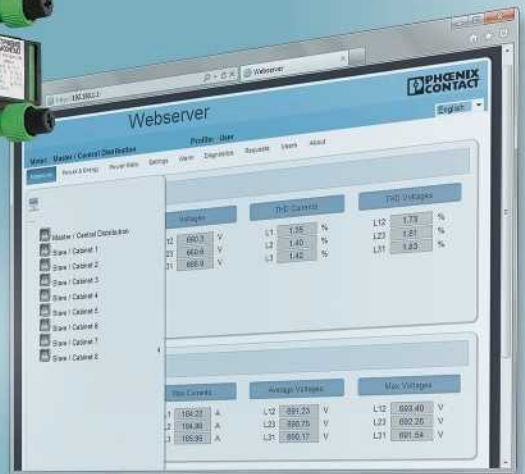

Monitoring

Energy and power measuring technology

EMpro energy meters measure, analyze, and communicate important electrical system parameters.

PSK DL data logger kits monitor and log operating states.

PSK meters record compressed air consumption.

Current transformers

PACT current transformers convert currents up to 4000 A into secondary currents of 1 and 5 A.

Current and voltage measuring technology

MCR current and voltage transducers convert currents and voltages into standard analog signals.

Solar and PV system monitoring

The SOLARCHECK modular monitoring system is used for string monitoring in photovoltaic systems.

Residual current monitoring

RCM devices provide residual current monitoring in grounded power supply systems. They detect residual currents at an early stage before they result in forced shutdown.

Components for E-Mobility

EV Charge Control is the charging controller used to charge electric vehicles on the AC mains according to IEC 61851-1.

Electronic monitoring relays

EMD monitoring relays detect and indicate deviations in important system parameters at an early stage.

Electronic timer relays

ETD timer relays are used for straightforward time control functions.

Special function modules

EMG special function modules enable simple components such as diodes to be used in an industrial context. These products feature professional housing and connection technology.

Product range overview

Product overview	194
Energy and power measuring technology	196
EMpro energy meters	200
Extension modules	202
Complete packages for data logging	206
Compressed air meters	208
Current transformers	210
Selection guide	212
PACT current transformers	213
Accessories	223
Current and voltage measuring technology	226
Current transducers	229
Voltage transducers	236
Accessories	237
Solar and PV system monitoring	238
SOLARCHECK PV string monitoring	240
Residual current monitoring	242
Residual current monitoring - RCM	244
Components for E-Mobility	246
EV Charge Control charging controller	247
Monitoring relays, timer relays, special function modules	248
EMD electronic monitoring relays	250
ETD electronic timer relays	258
EMG special function modules	262

Monitoring

Product overview

Energy and power measuring technology



EMpro energy meters for front-panel installation Page 200



EMpro energy meters for DIN rail mounting Page 201



Special function and communication modules Page 202



DIN rail adapters Page 205



PACT winding current transformers Page 222



Mounting accessories, shock protection Page 223



MCR current transducers for AC/DC and distorted currents up to 600 A Page 229



MCR current transducers for AC/DC and distorted currents up to 55 A, programmable Page 230

Current and voltage measuring technology



Accessories Configuration software and USB adapter cable Page 149



SOLARCHECK PV string monitoring Communication module Page 240



SOLARCHECK PV string monitoring Current measuring modules Page 241



SOLARCHECK PV string monitoring Voltage measuring modules Page 241

Solar and PV system monitoring

Monitoring relays



EMD-BL Compact monitoring relays Page 250



EMD Multifunctional monitoring relays Page 252

Timer relays



ETD-BL Ultra-narrow timer relays Page 258



ETD Multifunctional timer relays Page 260



Complete packages for data logging
Page 206



Compressed air meters
Page 208

Current transformers



PACT bus-bar current transformers
Page 212
Can be calibrated
Page 224



PACT plug-in current transformers
Page 214
Can be calibrated
Page 224



MCR current transducers for AC currents, sinusoidal up to 12 A
Page 232
Passive, up to 5 A
Page 234



MCR current transducers for AC currents, sinusoidal and distorted, up to 200 A
Page 233



MCR current protectors for AC currents, sinusoidal up to 16 A
Page 235



MCR voltage transducers for DC voltages up to 660 V
Page 236
For AC voltages up to 444 V
Page 236

Residual current monitoring



RCM type B+ for DC residual currents and pulsating DC and AC residual currents
Page 244



RCM type A for pulsating DC and AC residual currents
Page 245

Components for E-Mobility



EV Charge Control Charging controller
Page 247



EV Charge Lock Release Mains failure plug release
Page 247

Special function modules



EMG Diode modules, lamp testing modules, display modules
Page 262

Lightning current measuring system



Lightning current measuring system
See Catalog 6

HMI



HMI
See Catalog 8

Signal towers



Signal towers
See Catalog 8



Energy costs at a glance

Within industry, energy is viewed as a variable cost factor. As a result, lower energy costs are becoming increasingly important in terms of providing companies with a major competitive advantage in the areas of production, process, and industrial engineering.

Alongside energy consumption, the quality of the energy supplied, the reliability of supply, and effective system utilization also play an important role in ensuring profitability. This calls for continuous measurement and analysis of all sources of energy.

Advantages of energy data acquisition

Continuously recorded energy flow provides the basis for a target-oriented energy management system.

Access comprehensive information regarding the characteristic electrical data of your machinery and benefit from the advantages of this:

- Reduce your energy costs by identifying potential energy savings.
- Optimize your system capacity: through intelligent switching of system parts, uniform network load, and reduced harmonics.
- Reduce peak loads using forward-looking trend calculation and load management.
- Safeguard your production processes and minimize downtimes by continuously monitoring important system parameters.

Measurement – monitoring – communication

Efficient energy management – network-capable EMpro energy meters can be used to acquire and monitor the characteristic electrical data of your machines and systems.

They can be freely extended with communication modules and special function modules, enabling your energy meters to keep pace with your growing requirements. Future-proof planning and investment is therefore ensured.



The communication expert

The EMpro MA600 is capable of performing all measurement tasks associated with power supply applications up to 700 V AC – from straightforward current and power measurement and detection of harmonics to spectral analysis and trend calculation.

- Flexible network connection
- Can be extended with plug-in communication modules and special function modules
- Remote access via web server



The universal solution on the front panel

The EMpro MA400 is capable of all standard measurement tasks in the main distribution up to 500 V AC.

- Plug-in RS-485 extension module for integration in JBUS and MODBUS systems



The compact starter for use in the sub-distribution

The EMpro MA200 energy meter is ideal for simple measurement tasks where on-site analysis of the measured values is sufficient.

The highly communicative device for use on DIN rails

The EMpro MA250 performs simple measuring tasks in small control cabinets directly on the machine.

- With built-in RS-485 interface for integration in JBUS and MODBUS systems



Data logger kits

PSK DL data logger kits monitor the operating state of your plant and inform you of any change in state by SMS.

The complete package is available in two versions:

- PSK DL BASIC with all basic functions
- PSK DL FLEX allows programming directly in SQL and supports modular expansion. Sends e-mails via GPRS or DSL.



Sensors and meters

Use of resources at a glance - determine all relevant states using sensors and meters.

- Detailed procurement measurement, thanks to precise sensor and meter technology
- Intelligent sensor communication, thanks to IO-Link technology



Inline power measurement terminal

The Inline power measurement terminal enables analysis of AC networks.

- For measuring current, voltage, and power, as well as identifying distortion and harmonics

The power measurement terminal can be found in Catalog 8, control technology, I/O systems, and network structure.

Monitoring

Energy and power measuring technology

Energy meters

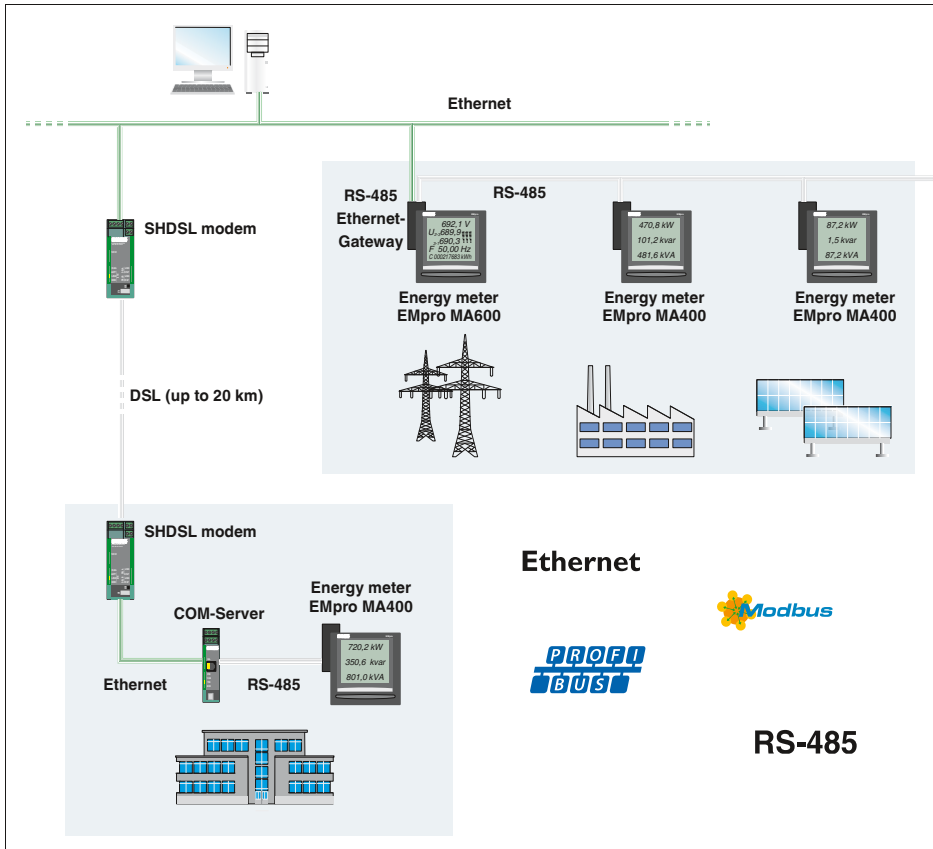

Measurement – monitoring – communication

In order to achieve efficient energy management, all energy data that has been determined is acquired and analyzed centrally in the control center.

For data transmission, integrate the EMpro measuring devices flexibly into your network structures.

The network components from Phoenix Contact offer interference-free and high-performance communication of energy data, even in harsh industrial environments:

- Copper-based and fiber optic data transmission
- Ethernet and modem communication
- Industrial wireless transmission



Direct access to measured values

Analyze your system parameters quickly on site. At the touch of a button, you can access precisely those measured values that are of relevance.

You can also use the user-friendly web server function to request measured values directly from the control center.



Planning reliability and investment security

EMpro extension modules, special function modules, and communication modules enable you to remain flexible and extend your EMpro measuring devices at any time:

- Digital inputs and outputs
- Pulse outputs
- Analog outputs
- Communication interfaces
- Measured data memory
- Temperature measurement



Remote access to multiple meters - with just one IP address

The web server that has been integrated into the Ethernet communication modules allows you to conveniently configure key parameters online. It also allows remote access to key electrical characteristics such as current, voltage, power, energy, and harmonics.

You can easily select the right device for your application by referring to the table below:

Product type	The compact starter EEM-MA200	The highly communicative device for use on DIN rails EEM-MA250 with RS-485	The universal solution on the front panel EEM-MA400	The communication expert EEM-MA600 EEM-MA600-24DC
Mounting				
DIN rail	•	•		
Front panel			•	•
Measurement				
Currents				
I1, I2, I3, Σ3	•	•		•
I1, I2, I3, IN (calculation)			•	•
Maximum values	•	•	•	•
Average values			•	•
Supports current measurement without an external transformer				•
Voltages				
U12, U23, U31, V1, V2, V3	•	•	•	•
Maximum values				•
Average values				•
Voltage measurement via voltage transducer				•
Voltage measurement, direct, up to 500 V	•	•	•	•
Voltage measurement, direct, up to 700 V				•
Frequency	•	•	•	•
Power				
ΣP, ΣQ, ΣS (±)	•	•	•	•
P, Q, S per phase (±)			•	•
Maximum values P, Q, S	•	•	•	•
Average values P, Q, S			•	•
Trend power				•
Power factor				
ΣPF	•	•	•	•
PF per phase			•	•
THD (Total Harmonic Distortion)				
I1, I2, I3, U12, U23, U31, V1, V2, V3	Up to 51st harmonic	Up to 51st harmonic	Up to 51st harmonic	Up to 63rd harmonic
Temperature				
Temperature measurement (internal)	•	•		
Metering				
Active and reactive energy (kWh+, kvarh+)	•	•	•	•
Active and reactive energy (kWh±, kvarh±)				•
Two-tariff meter	•	•		
Operating hours	•	•	•	•
Analysis				
Harmonics analysis				Up to 63rd harmonic
Outputs				
One configurable pulse output (kWh+, kvarh+) or alarm (threshold value)	•	•		
Inputs				
One configurable input for tariff switch-over	•	•		
Special function modules (optional)				
Memory				•
Two digital I/Os				•
One pulse output or one threshold value			•	
Two pulse outputs				•
Two analog outputs				•
Temperature measurement				•
Communication modules (optional)				
JBUS/Modbus RTU (RS-485)			•	•
PROFIBUS DP				•
PROFIBUS (D-SUB)				•
Ethernet				•
RS-485/Ethernet gateway				•

Key

I1, I2, I3	Conductor currents
IN	Neutral conductor current
U12, U23, U31	Phase conductor voltages
V1, V2, V3	Conductor voltages to N

P	Real power
Q	Reactive power
S	Apparent power
PF	Power factor
THD	Total harmonic distortion

Energy meters

EMpro energy meters are capable of acquiring, monitoring, and displaying all electrical system and machine parameters locally.

EEM-MA600

- Can be extended with special function and communication modules
- Remote access via web server, integrated into Ethernet communication module
- Acquisition of individual harmonic components up to 63rd order
- Trend calculation for active and reactive power

EEM-MA400

- Can be extended with a pulse module
- Can be extended with RS-485 communication module (JBUS/MODBUS)
- Acquisition of total harmonic content up to harmonic of 51st order

EEM-MA250

- Two-tariff measurement via pulse input
- Pulse output
- RS-485 interface (JBUS/MODBUS)

EEM-MA200

- Two-tariff measurement via pulse input
- Pulse output

Notes:

1) EMC: Class A product, see page 571



Measuring voltage of up to 700 V AC, extendable



Housing width 96 mm

Technical data

Input data	
Measuring principle	True r.m.s. value measurement
Acquisition of harmonics	up to 63rd harmonic
Measured value	AC sine (50/60 Hz)
Voltage measuring input V1, V2, V3	
Input voltage range	18 V AC ... 700 V AC (Phase/Phase) 11 V AC ... 404 V AC (Phase/neutral conductor) 500 kV AC (Primary, via external voltage transducers) (Secondary, 60, 100, 110, 115, 120, 173, 190 V AC)
Accuracy	0.2%
Current measuring input I1, I2, I3	
Input current range (Via external transformers)	9999 A (primary) (1 A and 5 A, secondary) 6 A (Permanent)
Overload capacity	10 mA
Operate threshold	0.2%
Accuracy	
Power measurement	
Measuring range	0 MW ... 8000 MW / 0 Mvar ... 8000 Mvar / 0 MVA ... 8000 MVA
Accuracy	0.5%
Active energy (IEC 62053-22)	Class 0.5S
Reactive power (IEC 62053-23)	Class 2
Digital input	
Voltage input signal	(Via extension module)
Switching output	
Output description	Via extension module
Maximum switching voltage	-
Current carrying capacity	-
Serial port	
Output description	Via extension module
Serial transmission speed	-
Display	
Type	LCD display, backlighting
Measuring rate	approximately
General data	
Supply voltage	
Nominal power consumption	10 VA 20 VA (With maximum number of extension modules)
Degree of protection	IP52 (front), IP30 (back)
Ambient temperature range	-10°C ... 55°C (14°F to 131°F)
Dimensions W / H / D	96 / 96 / 82 mm
Dimensions W / H / D With extension module	96 / 96 / 80 mm
Connection cross section (solid / stranded / AWG)	
Voltage and other connections	0.5 ... 2.5 mm ² / 0.5 ... 2.5 mm ² / 20 - 14
Current connection	0.5 ... 6 mm ² / 0.5 ... 6 mm ² / 20 - 8
Conformance / approvals	
Conformance	CE-compliant
UL, USA / Canada	UL 61010-1

Ordering data

Description	Type	Order No.	Pcs. / Pkt.
Energy meter, for installation in front panel	EEM-MA600 ¹⁾	2901366	1
Energy meter, for front-panel installation, 24 V DC			
Energy meter, for mounting on a DIN rail			



Measuring voltage of up to 700 V AC, supply voltage 24 V DC

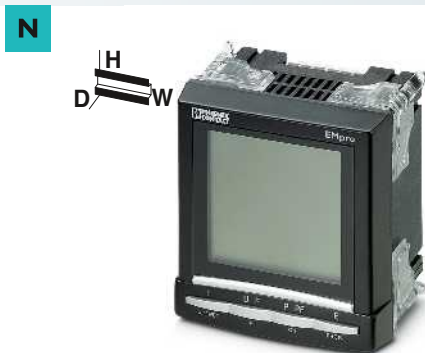

Measuring voltage of up to 500 V AC, can be extended with RS-485 interface



Measuring voltage of up to 500 V AC, with DIN rail mounting, also with RS-485 interface

Housing width 96 mm

Housing width 96 mm

Housing width 72 mm

Technical data	
True r.m.s. value measurement up to 63rd harmonic AC sine (50/60 Hz)	
18 V AC ... 700 V AC (Phase/Phase) 11 V AC ... 404 V AC (Phase/neutral conductor) 500 kV AC (Primary, via external voltage transducers) (Secondary, 60, 100, 110, 115, 120, 173, 190 V AC)	
0.2%	
9999 A (primary) (1 A and 5 A, secondary) 6 A (Permanent) 10 mA 0.2%	
0 MW ... 8000 MW / 0 Mvar ... 8000 Mvar / 0 MVA ... 8000 MVA	
0.5% Class 0.5S Class 2	
(Via extension module)	
Via extension module - -	
Via extension module -	
LCD display, backlighting approximately	
10 VA 20 VA (With maximum number of extension modules) IP52 (front), IP30 (back) -10°C ... 55°C (14°F to 131°F) 96 / 96 / 82 mm 96 / 96 / 80 mm	
0.5 ... 2.5 mm ² / 0.5 ... 2.5 mm ² / 20 - 14 0.5 ... 6 mm ² / 0.5 ... 6 mm ² / 20 - 8	
CE-compliant -	

Technical data	
True r.m.s. value measurement up to 51st harmonic AC sine (50/60 Hz)	
50 V AC ... 500 V AC (Phase/Phase) 28 V AC ... 289 V AC (Phase/neutral conductor) -	
0.2%	
9999 A (primary) 5 A (secondary) 6 A (Permanent) 5 mA 0.2%	
0 MW ... 11 MW / 0 Mvar ... 11 Mvar / 0 MVA ... 11 MVA	
0.5% Class 0.5S Class 2	
-	
Via extension module -	
Via extension module -	
LCD display, backlighting approximately	
5 VA 10 VA (With maximum number of extension modules) IP52 (front), IP30 (back) -10°C ... 55°C (14°F to 131°F) 96 / 96 / 82 mm 96 / 96 / 80 mm	
0.5 ... 2.5 mm ² / 0.5 ... 2.5 mm ² / 20 - 14 0.5 ... 6 mm ² / 0.5 ... 6 mm ² / 20 - 8	
CE-compliant UL 61010-1	

Technical data	
True r.m.s. value measurement up to 51st harmonic AC sine (50/60 Hz)	
50 V AC ... 519 V AC (Phase/Phase) 28 V AC ... 300 V AC (Phase/neutral conductor) -	
0.2%	
9999 A (primary) 5 A (secondary) 6 A (Permanent) 5 mA 0.2%	
0 kW ... 9999 kW / 0 kvar ... 9999 kvar / 0 kVA ... 9999 kVA	
0.5% Class 0.5S Class 2	
230 V AC ±10% (Tariff switchover: e.g., day/nighttime tariff)	
Transistor output, active 30 V DC 27 mA EEM-MA250 ¹⁾ EEM-MA200 ¹⁾ Modbus RTU/JBUS RS-485 None 2,4 ... 38.4 kbps	
LCD display, backlighting approximately	
5 VA IP51 (front), IP20 (back) -10°C ... 55°C (14°F to 131°F) 72 / 90 / 64 mm	
0.5 ... 2.5 mm ² / 0.5 ... 2.5 mm ² / 20 - 14 0.5 ... 4 mm ² / 0.5 ... 4 mm ² / 20 - 10	
CE-compliant UL 61010-1	

Ordering data		
Type	Order No.	Pcs. / Pkt.
EEM-MA600-24DC	2902352	1

Ordering data		
Type	Order No.	Pcs. / Pkt.
EEM-MA400 ¹⁾	2901364	1

Ordering data		
Type	Order No.	Pcs. / Pkt.
EEM-MA250 ¹⁾	2901363	1
EEM-MA200 ¹⁾	2901362	1

Monitoring

Energy and power measuring technology

Extension modules

Plug-in special function module for the EEM-MA600 energy meter

EEM-2DIO-MA600

- Two digital inputs and outputs
- Configurable threshold values

EEM-2AO-MA600

- Two 0 ... 20 mA/4 ... 20 mA analog outputs, configurable



Two digital inputs and outputs



Two analog outputs

Notes:
1) EMC: Class A product, see page 571

Digital input	
Voltage input signal	10 V DC ... 30 V DC
Input pulse length	10 ms
Output	
Output description	Relay output
Maximum switching voltage	250 V AC/DC
General data	
Supply voltage	9 V (via EEM-MA600)
Degree of protection	IP20
Ambient temperature range	-10°C ... 55°C (14°F to 131°F)
Conformance / approvals	
Conformance	CE-compliant
UL, USA / Canada	UL 61010-1

Technical data

Technical data

Ordering data

Type	Order No.	Pcs. / Pkt.
EEM-2DIO-MA600 ¹⁾	2901371	1

Ordering data

Type	Order No.	Pcs. / Pkt.
EEM-2AO-MA600 ¹⁾	2901475	1

Description	
Special function module (for EEM-MA600)	
With two digital I/Os	
With two analog outputs	

Extension modules

Plug-in special function module for the EEM-MA600 energy meter

EEM-MEMO-MA600

- Stores the last ten alarms together with the time and date
- Stores the real and reactive power, e.g., for 45 days with a 15-minute synchronization pulse

Notes:
1) EMC: Class A product, see page 571



Memory module

Digital input	
Voltage input signal	10 V DC ... 30 V DC
General data	
Supply voltage	9 V (via EEM-MA600)
Memory size	512 kByte
Degree of protection	IP20
Ambient temperature range	-10°C ... 55°C (14°F to 131°F)
Conformance / approvals	
Conformance	CE-compliant
UL, USA / Canada	UL 61010-1

Technical data

Description	
Memory module (for EEM-MA600)	

Ordering data

Type	Order No.	Pcs. / Pkt.
EEM-MEMO-MA600 ¹⁾	2901370	1

Extension modules

Communication modules

EEM-RS485-MA...

– JBUS/Modbus RTU (RS-485)

EEM-PB...-MA600

– PROFIBUS DP, with transmission speeds of 1.5 or 12 Mbps



RS-485



PROFIBUS

Notes:
1) EMC: Class A product, see page 571

Technical data	
Serial port	Modbus RTU/JBUS RS-485
Output description	2.4 ... 38.4 kbps
Serial transmission speed	
General data	
Supply voltage	9 V (via EEM-MA400)
Degree of protection	IP20
Ambient temperature range	-10°C ... 55°C (14°F to 131°F)
Conformance / approvals	
Conformance	CE-compliant
UL, USA / Canada	UL 61010-1

Ordering data		
Type	Order No.	Pcs. / Pkt.
EEM-RS485-MA400 ¹⁾	2901365	1
EEM-RS485-MA600 ¹⁾	2901367	1

Technical data	
EEM-PB-MA600 ¹⁾	EEM-PB12-MA600 ¹⁾
PROFIBUS DP RS-485	PROFIBUS DP RS-485
9.6 kbps ... 1.5 Mbps	9.6 kbps ... 12 Mbps
General data	
Supply voltage	9 V (via EEM-MA600)
Degree of protection	IP20
Ambient temperature range	-10°C ... 55°C (14°F to 131°F)
Conformance / approvals	
Conformance	CE-compliant
UL, USA / Canada	UL 61010-1

Ordering data		
Type	Order No.	Pcs. / Pkt.
EEM-PB-MA600 ¹⁾	2901368	1
EEM-PB12-MA600 ¹⁾	2901418	1

Description
Communication module (for EEM-MA400) JBUS/Modbus RTU (RS-485)
Communication module (for EEM-MA600) JBUS/Modbus RTU (RS-485) PROFIBUS DP (1.5 Mbps) PROFIBUS DP (12 Mbps)

Communication modules

EEM-ETH-MA600– Ethernet
– Integrated web server**EEM-ETH-RS485-MA600**– Ethernet/RS-485 gateway
– MODBUS RTU master for up to 246 slaves
– Integrated web server

Notes:
1) EMC: Class A product, see page 571

Serial port	Modbus TCP Ethernet (RJ45)
Output description	10/100 Mbps
Serial transmission speed	
General data	
Supply voltage	9 V (via EEM-MA600)
Degree of protection	IP20
Ambient temperature range	-10°C ... 55°C (14°F to 131°F)
Conformance / approvals	
Conformance	CE-compliant
UL, USA / Canada	UL 61010-1

Description
Communication module (for EEM-MA600) Ethernet
RS-485/Ethernet gateway

Ethernet
(MODBUS TCP)

Technical data	
Serial port	Modbus TCP Ethernet (RJ45)
Output description	10/100 Mbps
Serial transmission speed	
General data	
Supply voltage	9 V (via EEM-MA600)
Degree of protection	IP20
Ambient temperature range	-10°C ... 55°C (14°F to 131°F)
Conformance / approvals	
Conformance	CE-compliant
UL, USA / Canada	UL 61010-1

Ordering data		
Type	Order No.	Pcs. / Pkt.
EEM-ETH-MA600 ¹⁾	2901373	1

Ethernet/RS-485 gateway
(MODBUS TCP/MODBUS RTU)

Technical data	
Serial port	Modbus TCP Ethernet (RJ45)
Output description	10/100 Mbps
Serial transmission speed	
General data	
Supply voltage	9 V (via EEM-MA600)
Degree of protection	IP20
Ambient temperature range	-10°C ... 55°C (14°F to 131°F)
Conformance / approvals	
Conformance	CE-compliant
UL, USA / Canada	UL 61010-1

Ordering data		
Type	Order No.	Pcs. / Pkt.
EEM-ETH-RS485-MA600 ¹⁾	2901374	1

Extension module

Plug-in special function module for the EEM-MA600 energy meter

EEM-TEMP-MA600

- Temperature recording for up to three PT 100 temperature sensors
- Temperature measuring range $-20^{\circ}\text{C} \dots +150^{\circ}\text{C}$
- Internal temperature recording of the ambient temperature $-10^{\circ}\text{C} \dots +55^{\circ}\text{C}$

Notes:
1) EMC: Class A product, see page 571



Temperature module

Input data
Description of the input
Temperature range
Transmission error
Basic accuracy
General data
Supply voltage
Degree of protection
Ambient temperature range
Conformance / approvals
Conformance

Technical data		
Pt 100 input: 2, 3, 4-conductor		
$-20^{\circ}\text{C} \dots 150^{\circ}\text{C}$ (Connected sensors)		
$-10^{\circ}\text{C} \dots 55^{\circ}\text{C}$ (in the immediate vicinity)		
0.5 K/m (2-conductor)		
0.25 K/m (3-conductor)		
0 K/m (4-conductor)		
$\pm 1 \text{ K}$		
9 V (via EEM-MA600)		
IP20		
$-10^{\circ}\text{C} \dots 55^{\circ}\text{C}$ (14°F to 131°F)		
CE-compliant		

Description
Special function module (for EEM-MA600)

Ordering data		
Type	Order No.	Pcs. / Pkt.
EEM-TEMP-MA600 ¹⁾	2901949	1

Extension modules

N

N

Plug-in special function modules for the EEM-MA400 and EEM-MA600 energy meters.

EEM-IMP-MA400

- One configurable pulse output
- One configurable threshold value

EEM-IMP-MA600

- Two configurable pulse outputs



Pulse module



Pulse module

Digital input
Voltage input signal
Input pulse length
Output
Output description
Maximum switching voltage
General data
Supply voltage
Degree of protection
Ambient temperature range
Conformance / approvals
Conformance

Technical data		
-		
-		
Relay output		
100 V DC		
9 V (via EEM-MA400)		
IP20		
$-10^{\circ}\text{C} \dots 55^{\circ}\text{C}$ (14°F to 131°F)		
CE-compliant		

Description
Special function module (for EEM-MA600)
With two digital I/Os
With two analog outputs

Ordering data		
Type	Order No.	Pcs. / Pkt.
EEM-IMP-MA400	2904314	1

Technical data		
-		
-		
Relay output		
100 V DC		
9 V (via EEM-MA600)		
IP20		
$-10^{\circ}\text{C} \dots 55^{\circ}\text{C}$ (14°F to 131°F)		
CE-compliant		

Ordering data		
Type	Order No.	Pcs. / Pkt.
EEM-IMP-MA600	2904313	1

Measuring instrument bracket

- For mounting the EEM-MA600 or EEM-MA400 energy meters on a 35 mm DIN rail according to EN 60715

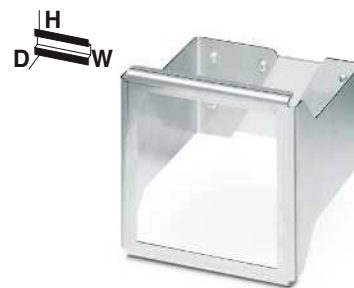

For mounting on DIN rails

General data		Technical data		
Vibration resistance		57 Hz ... 150 Hz (2 g)		
Weight		265 g		
DIN rail clip material		Aluminum, natural anodized		
Fixing sheet material		Stainless steel VA		
Dimensions W / H / D		116 / 112 / 115 mm		
Description		Ordering data		
DIN rail adapter for EEM-MA600 and EEM-MA400 energy meters		Type	Order No.	Pcs. / Pkt.
		EEM-MKT-DRA	2902078	1

Complete packages for data logging

BASIC data logger kit

Optimize your use of energy and resources. Data loggers from Phoenix Contact can be used to monitor and log the supply of water, compressed air, and electricity to your system. This enables efficient cost control. No additional software or operator panels are needed to parameterize data loggers – simply use a web browser on your PC.

The BASIC data logger kit features:

- Low installation and energy costs, thanks to parameterization via web interface without programming knowledge
- Comprehensive solution – complete package available under one order number
- Flexible communication, thanks to the integrated GSM/GPRS modem and Ethernet interface
- Maximum system availability, thanks to limit value monitoring
- Standardized data routing, thanks to SQL interface
- Process information sent to the user via e-mail or SMS
- Set digital outputs on the data logger via SMS
- Integrated FTP and web server



Technical data

See www.phoenixcontact.net/products

Ordering data

Description
Parameterizable data logger kit with Ethernet interface and GSM modem, including power supply unit with 8 digital outputs and 16 digital inputs, plus accessories and patch cable

Type	Order No.	Pcs. / Pkt.
PSK DL BASIC	2700726	1

Complete packages for data logging

Notes:
1) EMC: Class A product, see page 571

FLEX data logger kit

The PSK DL FLEX data logger kit is the extended version of the PSK DL BASIC basic package. A maximum of three digital input terminals and four analog input terminals from the Inline I/O system can also be connected to the FLEX kit. The mounted terminals are automatically detected and started up. The PSK DL FLEX can be used to send digital and analog status information via SMS or e-mail or via mobile phone networks or Ethernet. In addition, the PSK DL FLEX can write the information directly to an SQL database that is provided.

In addition to all the properties of the BASIC version, the FLEX extended solution kit also offers the following:

- Direct SQL connection via SQL interface
- Process information via e-mail and SMS
- Flexible extension with additional I/O modules



Technical data

See www.phoenixcontact.net/products

Ordering data

Type	Order No.	Pcs. / Pkt.
PSK DL FLEX	2700727	1

Description
Extendable parameterizable data logger kit with Ethernet interface and GSM/GPRS modem, including power supply unit with 8 digital outputs, 24 digital inputs, and 8 analog inputs, plus accessories and patch cable

Accessories

Inline digital input terminal , complete with accessories (connector and labeling field)
- 2 inputs
- 4 inputs
- 8 inputs
- 16 inputs
- S0 counter
Inline analog input terminal , complete with accessories (connector and labeling field)
- 2 inputs
- 8 inputs
- 8 inputs, initiator with supply outputs

IB IL 24 DI 2-PAC¹⁾	2861221	1
IB IL 24 DI 4-PAC¹⁾	2861234	1
IB IL 24 DI 8-PAC¹⁾	2861247	1
IB IL 24 DI 16-PAC¹⁾	2861250	1
IB IL DI 8/S0-PAC¹⁾	2897020	1
IB IL AI 2/SF-PAC¹⁾	2861302	1
IB IL AI 8/SF-PAC¹⁾	2861412	1
IB IL AI 8/IS-PAC¹⁾	2861661	1

Sensors and meters

Compressed air meters

Use meters from Phoenix Contact to monitor the use of compressed air, an expensive production resource. By using compressed air efficiently, you can decrease compressor usage and therefore reduce energy costs. The calorimetric measuring procedure records even the smallest consumption rates. You can therefore detect wear or leaks based on the amount of air consumed.

Use compressed air meters to acquire the following values:

- The current volumetric flow according to ISO 2533 and DIN 1343
- The total volume used
- The temperature of the compressed air in the monitored operating processes

The compressed air meters impress thanks to their:

- Detailed reference measurement with flow rate, total volume, and temperature display
- Intelligent sensor communication, thanks to IO-Link technology
- Measuring range from 0.06 Nm³/h to 700.0 Nm³/h
- Flexible use, thanks to IP65 protection: resistant to dust and splash water

IO-Link



Compressed air counter up to 75 Nm³/h



Flow monitoring	
Measuring range	
Display area	
Repeatability	
Response time	
Measured value error	
Temperature monitoring	
Measuring range	
Display area	
Response time	
Resolution	
Accuracy	
Supply for module electronics	
Connection method	
No. of pos.	
Supply voltage range	
Current draw	
Digital outputs	
Pulse value	
Pulse length	
Delay time	
Analog outputs	
Type of protection	
Current output signal	
Load/output load current output	
General data	
Weight	
Width	
Height	
Depth	
Degree of protection	
Protection class	
Ambient temperature (operation)	
Ambient temperature (storage/transport)	
Vibration resistance according to IEC 60068-2-6	

Technical data		
	PSK AFS6050IOL	PSK AFS6000IOL
Measuring range	0 Nm ³ /h ... 75 Nm ³ /h	0 Nm ³ /h ... 90 Nm ³ /h
Repeatability	(±1.5% of the measured value)	
Response time	< 0.1 s ((dAP = 0))	
Measured value error	±15% of the measured value +1.5% of the measuring range final value	Depending on the air quality: ±3% of the measured value +0.3% of the measuring range final value; ±6% of the measured value +0.6% of the measuring range final value
Temperature monitoring		
Measuring range	0°C ... 60°C	
Display area	-12°C ... 72°C	
Response time	30 s (Q > 0.1 Nm ³ /h)	
Resolution	0.5°C	
Accuracy	±2.5°C (Q > 0.1 Nm ³ /h)	
Supply for module electronics		
Connection method	M12 plug-in connector	
No. of pos.	4	
Supply voltage range	19 V DC ... 30 V DC	
Current draw	< 100 mA	
Digital outputs		
Pulse value	0.0010 m ³ ... 1000000 m ³	
Pulse length	min. 0.04 s	
Delay time	0.5 s (Operational readiness)	
Analog outputs		
Type of protection	Short-circuit protection, polarity reversal protection	
Current output signal	4 mA ... 20 mA	
Load/output load current output	≤ 500 Ω	
General data		
Weight	581 g	961 g
Width	45 mm	
Height	111 mm	300 mm
Depth	79.5 mm	76.8 mm
Degree of protection	IP65	
Protection class	III	
Ambient temperature (operation)	0°C ... 60°C	
Ambient temperature (storage/transport)	-20°C ... 85°C	
Vibration resistance according to IEC 60068-2-6	5 g (55 ... 2000 Hz)	

Description
Compressed air meter: G1/2 process connection, measuring range up to 75 Nm ³ /h
Compressed air meter: G1/2 process connection, measuring range up to 75 Nm ³ /h
Compressed air meter: R1/4 process connection, measuring range up to 15 Nm ³ /h
Compressed air meter: R1 process connection, measuring range up to 225 Nm ³ /h
Compressed air meter: R2 process connection, measuring range up to 700 Nm ³ /h

Ordering data		
Type	Order No.	Pcs. / Pkt.
PSK AFS6050IOL	2700704	1
PSK AFS6000IOL	2700707	1

N

N

N

IO-Link



Compressed air counter up to 15 Nm³/h

IO-Link



Compressed air counter up to 225 Nm³/h

IO-Link



Compressed air counter up to 700 Nm³/h



Technical data

Technical data

Technical data

0 Nm³/h ... 15 Nm³/h
 0 Nm³/h ... 18 Nm³/h
 (±1.5% of the measured value)
 < 0.1 s ((dAP = 0))
 Depending on the air quality: ±3% of the measured value +0.3% of the measuring range final value; ±6% of the measured value +0.6% of the measuring range final value

0 Nm³/h ... 225 Nm³/h
 0 Nm³/h ... 270 Nm³/h
 (±1.5% of the measured value)
 < 0.1 s ((dAP = 0))
 Depending on the air quality: ±3% of the measured value +0.3% of the measuring range final value; ±6% of the measured value +0.6% of the measuring range final value

2 Nm³/h ... 700 Nm³/h
 0 Nm³/h ... 840 Nm³/h
 (±1.5% of the measured value)
 < 0.1 s ((dAP = 0))
 Depending on the air quality: ±3% of the measured value +0.3% of the measuring range final value; ±6% of the measured value +0.6% of the measuring range final value

0°C ... 60°C
 -12°C ... 72°C
 30 s (Q > 0.1 Nm³/h)
 0.5°C
 ±2.5°C (Q > 0.1 Nm³/h)

0°C ... 60°C
 -12°C ... 72°C
 30 s (Q > 0.1 Nm³/h)
 0.5°C
 ±2.5°C (Q > 0.1 Nm³/h)

0°C ... 60°C
 -12°C ... 72°C
 30 s (Q > 0.1 Nm³/h)
 0.5°C
 ±2.5°C (Q > 0.1 Nm³/h)

M12 plug-in connector
 4
 19 V DC ... 30 V DC
 < 100 mA

M12 plug-in connector
 4
 19 V DC ... 30 V DC
 < 100 mA

M12 plug-in connector
 4
 19 V DC ... 30 V DC
 < 100 mA

0.0010 m³ ... 1000000 m³
 min. 0.2 s
 0.5 s (Operational readiness)

0.0030 m³ ... 3000000 m³
 min. 0.02 s
 1 s (Operational readiness)

0.0100 m³ ... 4000000 m³
 min. 0.043 s
 0.5 s (Operational readiness)

Short-circuit protection, polarity reversal protection
 4 mA ... 20 mA
 ≤ 500 Ω

Short-circuit protection, polarity reversal protection
 4 mA ... 20 mA
 ≤ 500 Ω

Short-circuit protection, polarity reversal protection
 4 mA ... 20 mA
 ≤ 500 Ω

887 g
 45 mm
 193.3 mm
 74.5 mm
 IP65
 III
 0°C ... 60°C
 -20°C ... 85°C
 5 g (55 ... 2000 Hz)

2.053 kg
 45 mm
 475 mm
 88.5 mm
 IP65
 III
 0°C ... 60°C
 -20°C ... 85°C
 5 g (55 ... 2000 Hz)

4.332 kg
 133 mm
 475 mm
 -
 IP65
 III
 0°C ... 60°C
 -20°C ... 85°C
 5 g (55 ... 2000 Hz)

Ordering data

Ordering data

Ordering data

Type	Order No.	Pcs. / Pkt.
PSK AFS5000IOL	2700705	1

Type	Order No.	Pcs. / Pkt.
PSK AFS8000IOL	2700708	1

Type	Order No.	Pcs. / Pkt.
PSK AFS2000IOL	2700709	1



Extremely versatile

PACT current transformers offer a complete product range for converting alternating currents up to 4000 A into secondary currents of 1 A and 5 A. Depending on requirements, bus-bar, plug-in, and winding current transformers are available. PACT current transformers are available in different transformation ratios, accuracy classes, and rated powers - in 3000 versions, for your current measurement requirements.

Also available for higher accuracy classes

For standard applications, such as in machine building or system manufacturing, Phoenix Contact offers current transformers with accuracy classes 0.5 and 1 in a version that cannot be calibrated.

For higher accuracy or for billing purposes in energy supply, type-tested transformers that can be calibrated as well as calibrated transformers are available - with classes 0.2/0.2S/0.5 and 0.5S.



Fast and secure installation

The current transformer quick-action mechanism offers the following advantages:

- Tool-free mounting
- Considerable reduction in installation time
- Easy handling and secure fastening by pressing with finger
- Current transformers align themselves – no need for subsequent alignment

Variable and space-saving mounting

In addition to the vertical and horizontal mounting position, the optional accessories offer further installation options such as mounting on the DIN rail or on the control cabinet panel.

All PACT current transformers are just 30 mm wide. This saves space – for example flat mounting when measuring branch outlets.

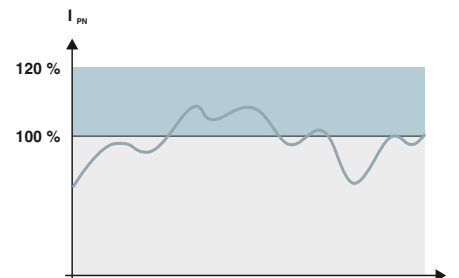

Safe detection of current peaks

PACT current transformers can be used to safely detect current peaks greater than the rated nominal current strength – without resulting in any damage: the transformers are designed for a continuous thermal nominal current that is 120% of the primary rated current strength.

Example: a PACT transformer with a specified rated power of 10 VA does indeed deliver 14.4 VA on a continual basis.

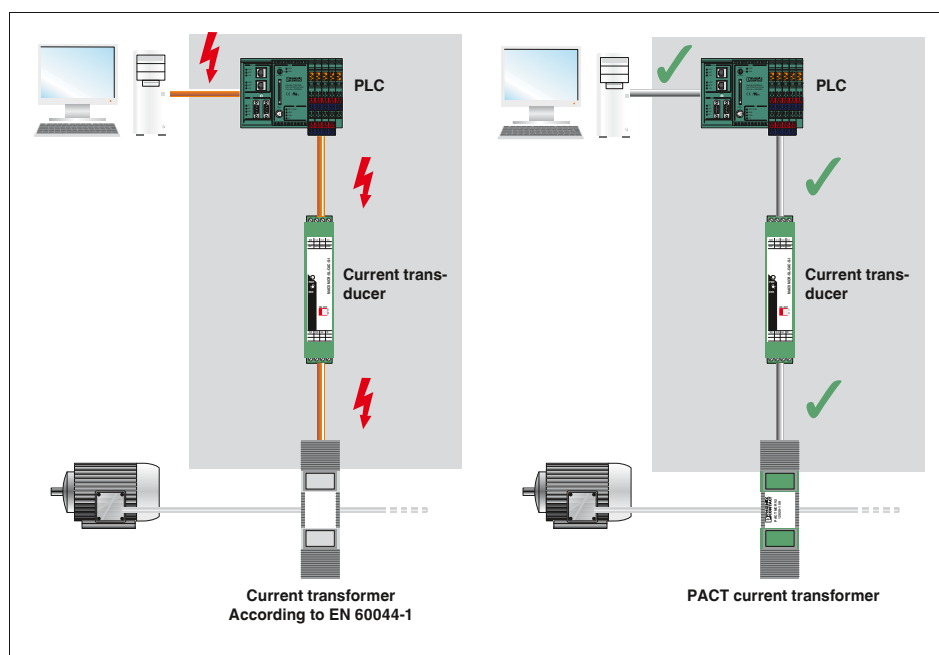

Safe isolation

PACT current transformers are manufactured in accordance with EN 50178. This is relevant for electronic equipment for use in power installations.

EN 50178 differs considerably from EN 60044, the usual standard for transformers, with regard to safety.

Your advantages:

- PACT current transformers offer safe isolation, thanks to greater air and creepage distances
- PACT current transformers ensure that there is no sparkover on the secondary side of the transformer and human life is protected inside and outside the control cabinet
- Up to 1000 V (L-N) operating voltage possible
- Routine testing with 12 kV (1.2/50 μ s)
- Surge voltage category 3 is met

Monitoring

Current transformers

Selection guide

- Complete range consisting of winding, bus-bar, and plug-in current transformers
- Popular types available from stock; alternatively, order key can be used for custom dimensioning
- Versions available to support official calibration

Selection

- Select your converter in accordance with the dimensions of the copper rail
- Specify the four electrical characteristics of the converter:

- 1. The primary rated current strength I_{pn}** - the maximum amperage occurring in the path to be measured
- 2. The secondary rated current I_{sn}** - supplied to the downstream measuring devices
- 3. Class** - accuracy for adherence to the specified tolerances
- 4. Rated power S_n [VA]** - takes account of all the loads occurring in the measuring circuit



Input data

Thermal rated short-time current
 Rated surge current
 Rated frequency
 Surge current limitation factor

General data

Rated insulation voltage
 Test voltage
 Impulse withstand voltage
 Insulating material class
 Connection capacity of secondary terminals
 Ambient temperature (operation)
 Standards/regulations
 Housing material

Technical data

$I_{th} = 60 \cdot I_n$
 $I_{dyn} = 2.5 \cdot I_{th}$
 50 Hz ... 60 Hz
 FS 5

1 kV
 3 kV (50 Hz, 1 min.)
 12 kV (1.2 / 50 μs)
 E
 2 x (2,5 x 4) mm
 -25°C ... 40°C
 IEC 60044-1, EN 50178
 Polyamide PA fiberglass reinforced

Calculation guide

Determination of the secondary side rated power S_n

- All the occurring loads must be added:
- Calculate the power requirement of the copper cable (forward and return line)
 - Take into account the power requirement of the connected devices (measuring devices)
 - Add a reserve requirement

$$S_n \text{ total} = S_n \text{ copper cable} + S_n \text{ measuring device} + S_n \text{ reserve}$$

Power requirement of copper cables with a different diameter

Conductor cross section in mm ²	Rated power in VA/m (consider the forward and return line)	
	Secondary current I_{sn} 5 A	Secondary current I_{sn} 1 A
1.5	0.2917	0.0117
2.5	0.1750	0.0070
4	0.1094	0.0044
6	0.0729	0.0029

Example:
 S_n copper cable = cable length x 2 x rated power
 S_n copper cable = 10 m x 2 x 0.1750 VA/m = 3.50 VA

S_n measuring device = 2 VA

S_n reserve < 0.5 x (S_n copper cable + S_n measuring device)
 S_n reserve = 2 VA

S_n total = S_n copper cable + S_n measuring device + S_n reserve
 S_n total = 3.5 VA + 2 VA + 2 VA = 7.5 VA

Order key - example for PACT MCR-V2-3015-60

Preferred types that can be ordered directly are marked in green in the selection table.

Order No.	Primary current I_{pn}	Secondary current I_{sn}	Class	Rated power S_n
2277271	IP02000	IS05	C10	P750
	IP00600 ≙ 60 A IP00750 ≙ 75 A IP00800 ≙ 80 A IP01000 ≙ 100 A IP01250 ≙ 125 A IP02000 ≙ 200 A IP02500 ≙ 250 A	IS01 ≙ 1 A IS05 ≙ 5 A	C02 ≙ 0.2 C05 ≙ 0.5 C10 ≙ 1	P125 ≙ 1.25 VA P250 ≙ 2.5 VA P375 ≙ 3.75 VA P500 ≙ 5.0 VA P750 ≙ 7.5 VA P1000 ≙ 10 VA

1. 2. 3. 4.

Selection table (extract)

I_{sn}	Cl.	Primary rated current strength I_{pn} [A]								Rated power S_n [VA]
		60	75	80	100	125	150	200	250	
1A	0.5							2.5	2.5	2.5 3.75 5 7.5
	1	1.25	2.5	2.5	2.5	2.5	2.5	2.5	2.5	
5A	0.5							3.75	5	2.5 3.75 5 7.5 10
	1	1.25	1.25	1.25	2.5	2.5	2.5	2.5	2.5	

Current transformers

PACT MCR-V1-21-44

- Primary rated current I_{pn} : 0...(50...500) A
- Round conductor dimensions: \varnothing 21 mm

Notes:
Our configurator, which is available at www.phoenixcontact.net/products , makes ordering easy.
Current transformers that support official calibration: To specify the type of current transformer you require, please use the order key on page 224
The relevant installation accessories can be found on page 223

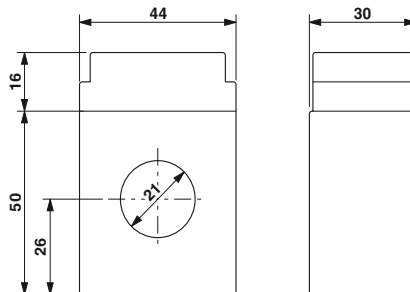

Bus-bar curr. transf., official calibration as an option

Description		Rated power S_n	Ordering data		
Description		Rated power S_n	Type	Order No.	Pcs. / Pkt.
Preferred versions available from stock (marked in green in the selection table)					
Primary rated current I_{pn} :					
- 50 A		1.25 VA	PACT MCR-V1-21-44- 50-5A-1	2277019	1
- 75 A		2.5 VA	PACT MCR-V1-21-44- 75-5A-1	2277611	1
- 100 A		2.5 VA	PACT MCR-V1-21-44-100-5A-1	2277022	1
- 125 A		3.75 VA	PACT MCR-V1-21-44-125-5A-1	2277763	1
- 150 A		5 VA	PACT MCR-V1-21-44-150-5A-1	2277035	1
- 200 A		5 VA	PACT MCR-V1-21-44-200-5A-1	2277776	1
- 250 A		5 VA	PACT MCR-V1-21-44-250-5A-1	2277048	1
- 300 A		10 VA	PACT MCR-V1-21-44-300-5A-1	2277789	1
- 400 A		5 VA	PACT MCR-V1-21-44-400-5A-1	2277051	1
- 500 A		10 VA	PACT MCR-V1-21-44-500-5A-1	2277792	1
Current transformers , pay attention to the following order key for determining the desired current transformer type					
			PACT MCR-V1-21-44	2277268	1

Add **order key** from the selection table (ordering example marked in orange)

Order No.	Primary current I_{pn}	Secondary current I_{sn}	Class	Rated power S_n
2277268	IP05000	IS01	C05	P1000

Selection table PACT MCR-V1-21-44 (Order No.: 2277268)

I_{sn}	Cl.	Primary rated current amperage I_{pn} [A]											Rated power S_n [VA]				
		50	60	75	80	100	125	150	200	250	300	400		500			
IS01 ≈ 1 A	C05 ≈ 0.5					1.25	2.5	2.5	2.5	2.5	2.5	2.5	2.5	2.5	2.5	2.5	
	C10 ≈ 1							3.75	5	5	5	5	5	5	5	5	
IS05 ≈ 5 A	C05 ≈ 0.5					1.25	1.25	1.25	2.5	2.5	2.5	2.5	2.5	2.5	2.5	2.5	
	C10 ≈ 1	1.25	1.25	2.5	2.5	2.5	2.5	2.5	2.5	2.5	2.5	2.5	2.5	2.5	2.5	2.5	

Monitoring

Current transformers

Current transformers

PACT MCR-V2-3015-60

- Primary rated current I_{pn} : 0...(50...750) A
- Round conductor dimensions: \varnothing 28 mm
- Rail dimensions: 30x15 mm; 20x20 mm

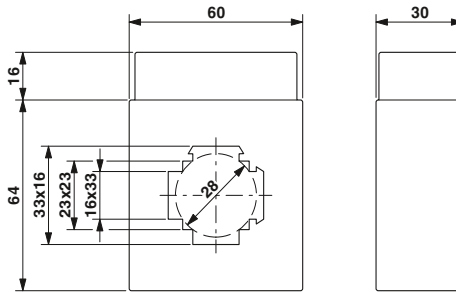

Plug-in curr. transformer, official calibration as an option

Notes:
Our configurator, which is available at www.phoenixcontact.net/products , makes ordering easy.
Current transformers that support official calibration: To specify the type of current transformer you require, please use the order key on page 224
The relevant installation accessories can be found on page 223

Ordering data

Description	Rated power S_n	Type	Order No.	Pcs. / Pkt.
Preferred versions available from stock (marked in green in the selection table)				
Primary rated current I_{pn} :				
- 60 A	1.25 VA	PACT MCR-V2-3015- 60- 60-5A-1	2277815	1
- 75 A	1.25 VA	PACT MCR-V2-3015- 60- 75-5A-1	2277828	1
- 75 A	1.5 VA	PACT MCR-V2- 3015- 60- 75-5A-1	2276502	1
- 80 A	1.25 VA	PACT MCR-V2-3015- 60- 80-5A-1	2277831	1
- 100 A	2.5 VA	PACT MCR-V2-3015- 60- 100-5A-1	2277064	1
- 125 A	3.75 VA	PACT MCR-V2-3015- 60- 125-5A-1	2277624	1
- 150 A	3.75 VA	PACT MCR-V2-3015- 60- 150-5A-1	2277844	1
- 150 A	5 VA	PACT MCR-V2-3015- 60- 150-5A-1	2277077	1
- 200 A	5 VA	PACT MCR-V2-3015- 60- 200-5A-1	2277637	1
- 200 A	7.5 VA	PACT MCR-V2-3015- 60- 200-5A-1	2277857	1
- 250 A	5 VA	PACT MCR-V2- 3015- 60-250-5A-1	2276544	1
- 250 A	7.5 VA	PACT MCR-V2-3015- 60- 250-5A-1	2277860	1
- 250 A	10 VA	PACT MCR-V2-3015- 60- 250-5A-1	2277080	1
- 300 A	7.5 VA	PACT MCR-V2-3015- 60- 300-5A-1	2277640	1
- 400 A	10 VA	PACT MCR-V2-3015- 60- 400-5A-1	2277093	1
- 500 A	10 VA	PACT MCR-V2-3015- 60- 500-5A-1	2277653	1
- 600 A	10 VA	PACT MCR-V2-3015- 60- 600-5A-1	2277103	1
- 750 A	10 VA	PACT MCR-V2-3015- 60- 750-5A-1	2277666	1
Current transformers , pay attention to the following order key for determining the desired current transformer type				
PACT MCR-V2- 3015- 60			2277271	1

Accessories

Quick-action mechanism ; width of the holding latch 16 mm				
Fixing pin length 40 mm				
Quick-action mechanism ; width of the holding latch 16 mm				
Fixing pin length 65 mm				
PACT-FAST-MNT-W16-L40			2276638	1
PACT-FAST-MNT-W16-L65			2276641	1

Add **order key** from the selection table (ordering example marked in orange)

Order No.	Primary current I_{pn}	Secondary current I_{sn}	Class	Rated power S_n
2277271	IP07500	IS01	C05	P1500

Selection table PACT MCR-V2-3015-60 (Order No.: 2277271)

I_{sn}	Cl.	Primary rated current amperage I_{pn} [A]													Rated power S_n [VA]								
		50	60	75	80	100	125	150	200	250	300	400	500	600		750							
IS01 ≅ 1 A	C05 ≅ 0.5					1.25	2.5	2.5		2.5	2.5	2.5	2.5	2.5	2.5	2.5	2.5	2.5	2.5	2.5	2.5	2.5	2.5
	C10 ≅ 1									3.75	5	5	5	5	5	5	5	5	5	5	5	5	5
IS05 ≅ 5 A	C05 ≅ 0.5													2.5	2.5	2.5	2.5	2.5	2.5	2.5	2.5	2.5	2.5
	C10 ≅ 1													3.75	3.75	5	5	5	5	5	5	5	5

Current transformers

PACT MCR-V2-4012-70

- Primary rated current I_{pn} : 0...(75...1000) A
- Round conductor dimensions: \varnothing 33 mm
- Rail dimensions: 40x12 mm; 2x 30x10 mm

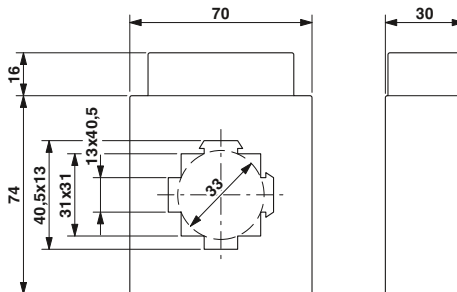

Plug-in curr. transformer, official calibration as an option

Notes:
 Our configurator, which is available at www.phoenixcontact.net/products, makes ordering easy.
 Current transformers that support official calibration: To specify the type of current transformer you require, please use the order key on page 224
 The relevant installation accessories can be found on page 223

Description	Rated power S_n
Preferred versions available from stock (marked in green in the selection table)	
Primary rated current I_{pn} :	
- 250 A	5 VA
- 300 A	7.5 VA
- 400 A	7.5 VA
- 500 A	10 VA
- 600 A	10 VA
- 750 A	10 VA
- 800 A	10 VA
- 1000 A	10 VA
Current transformers , pay attention to the following order key for determining the desired current transformer type	

Ordering data		
Type	Order No.	Pcs. / Pkt.
PACT MCR-V2-4012- 70- 250-5A-1	2277116	1
PACT MCR-V2-4012- 70- 300-5A-1	2277679	1
PACT MCR-V2-4012- 70- 400-5A-1	2277129	1
PACT MCR-V2-4012- 70- 500-5A-1	2277682	1
PACT MCR-V2-4012- 70- 600-5A-1	2277132	1
PACT MCR-V2-4012- 70- 750-5A-1	2277695	1
PACT MCR-V2-4012- 70- 800-5A-1	2277145	1
PACT MCR-V2-4012- 70-1000-5A-1	2277158	1
PACT MCR-V2- 4012- 70	2277284	1

Quick-action mechanism; width of the holding latch 13 mm
 Fixing pin length 40 mm
Quick-action mechanism; width of the holding latch 13 mm
 Fixing pin length 65 mm

Accessories		
Type	Order No.	Pcs. / Pkt.
PACT-FAST-MNT-W13-L40	2276612	1
PACT-FAST-MNT-W13-L65	2276625	1

Add order key from the selection table (ordering example marked in orange)

Order No.	Primary current I_{pn}	Secondary current I_{sn}	Class	Rated power S_n
2277284	IP010000	IS05	C10	P250

Selection table PACT MCR-V2-4012-70 (Order No.: 2277284)

I_{sn}	Cl.	Primary rated current strength I_{pn} [A]											Rated power S_n [VA]					
		75	80	100	125	150	200	250	300	400	500	600		750	800	1000		
≈ 1 A	C05 ≈ 0.5				1.25	2.5	3.75	5	5	5	5	5	5	5	5	5	5	
										7.5	10	10	10	10	10	10	10	
	C10 ≈ 1		1.25	1.25	2.5	2.5	2.5	2.5	2.5	2.5	2.5	2.5	2.5	2.5	2.5	2.5	2.5	2.5
						3.75	5	5	5	5	5	5	5	5	5	5	5	5
≈ 5 A	C05 ≈ 0.5				1.25	2.5	3.75	5	5	5	5	5	5	5	5	5	5	
										7.5	10	10	10	10	10	10	10	
	C10 ≈ 1		1.25	1.25	2.5	2.5	2.5	2.5	2.5	2.5	2.5	2.5	2.5	2.5	2.5	2.5	2.5	2.5
						3.75	5	5	5	5	5	5	5	5	5	5	5	5

Monitoring

Current transformers

Current transformers

PACT MCR-V2-5012-85

- Primary rated current I_{pn} : 0...(100...1500) A
- Round conductor dimensions: \varnothing 42 mm
- Rail dimensions: 50x12 mm; 2x 40x10 mm

Notes:
Our configurator, which is available at www.phoenixcontact.net/products , makes ordering easy.
Current transformers that support official calibration: To specify the type of current transformer you require, please use the order key on page 224
The relevant installation accessories can be found on page 223

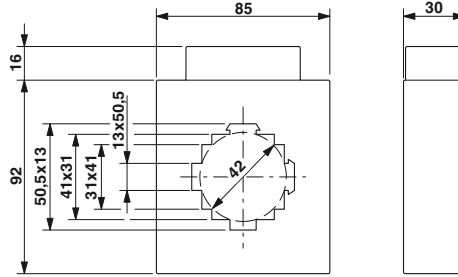

Plug-in curr. transformer, official calibration as an option

Description		Rated power S_n	Ordering data		
Type	Order No.	Pcs. / Pkt.			
Preferred versions available from stock (marked in green in the selection table)					
Primary rated current I_{pn} :					
- 150 A	3.75 VA	PACT MCR-V2-5012- 85- 150-5A-1	2276117	1	
- 200 A	5 VA	PACT MCR-V2-5012- 85- 200-5A-1	2276120	1	
- 250 A	7.5 VA	PACT MCR-V2-5012- 85- 250-5A-1	2276133	1	
- 300 A	10 VA	PACT MCR-V2-5012- 85- 300-5A-1	2276146	1	
- 400 A	10 VA	PACT MCR-V2-5012- 85- 400-5A-1	2277161	1	
- 500 A	15 VA	PACT MCR-V2-5012- 85- 500-5A-1	2276159	1	
- 600 A	10 VA	PACT MCR-V2-5012- 85- 600-5A-1	2277174	1	
- 600 A	15 VA	PACT MCR-V2-5012- 85- 600-5A-1	2276162	1	
- 750 A	10 VA	PACT MCR-V2-5012- 85- 750-5A-1	2276175	1	
- 800 A	10 VA	PACT MCR-V2-5012- 85- 800-5A-1	2277187	1	
- 1000 A	10 VA	PACT MCR-V2-5012- 85-1000-5A-1	2276463	1	
- 1000 A	15 VA	PACT MCR-V2-5012- 85-1000-5A-1	2277190	1	
- 1250 A	15 VA	PACT MCR-V2-5012- 85-1250-5A-1	2277200	1	
- 1500 A	15 VA	PACT MCR-V2-5012- 85-1500-5A-1	2276188	1	
Current transformers , pay attention to the following order key for determining the desired current transformer type					
PACT MCR-V2- 5012- 85			2277297	1	

Quick-action mechanism: width of the holding latch 13 mm
Fixing pin length 40 mm
Quick-action mechanism: width of the holding latch 13 mm
Fixing pin length 65 mm

Accessories		
Type	Order No.	Pcs. / Pkt.
PACT-FAST-MNT-W13-L40	2276612	1
PACT-FAST-MNT-W13-L65	2276625	1

Add order key from the selection table (ordering example marked in orange)

Order No.	Primary current I_{pn}	Secondary current I_{sn}	Class	Rated power S_n
2277297	IP02500	IS01	C10	P750

Selection table PACT MCR-V2-5012-85 (Order No.: 2277297)

I_{sn}	Cl.	Primary rated current amperage I_{pn} [A]														Rated power S_n [VA]										
		100	125	150	200	250	300	400	500	600	750	800	1000	1250	1500											
IS01 ≅ 1 A	C05 ≅ 0.5			1.25	2.5	2.5	2.5	2.5	2.5	2.5	2.5	2.5	2.5	2.5	2.5	2.5	2.5	2.5	2.5	2.5	2.5	2.5	2.5	2.5	2.5	
					5	5	5	5	5	5	5	5	5	5	5	5	5	5	5	5	5	5	5	5	5	5
	C10 ≅ 1	1.25	2.5	2.5	2.5	2.5	2.5	2.5	2.5	2.5	2.5	2.5	2.5	2.5	2.5	2.5	2.5	2.5	2.5	2.5	2.5	2.5	2.5	2.5	2.5	2.5
IS05 ≅ 5 A	C05 ≅ 0.5			1.25	2.5	2.5	2.5	2.5	2.5	2.5	2.5	2.5	2.5	2.5	2.5	2.5	2.5	2.5	2.5	2.5	2.5	2.5	2.5	2.5	2.5	2.5
					5	5	5	5	5	5	5	5	5	5	5	5	5	5	5	5	5	5	5	5	5	5
	C10 ≅ 1	1.25	2.5	2.5	2.5	2.5	2.5	2.5	2.5	2.5	2.5	2.5	2.5	2.5	2.5	2.5	2.5	2.5	2.5	2.5	2.5	2.5	2.5	2.5	2.5	2.5
				3.75	5	5	5	5	5	5	5	5	5	5	5	5	5	5	5	5	5	5	5	5	5	5
					7.5	7.5	10	10	10	10	10	10	10	10	10	10	10	10	10	10	10	10	10	10	10	10
							10	15	20	20	20	20	20	20	20	20	20	20	20	20	20	20	20	20	20	20

Current transformers

PACT MCR-V2-6015-85

- Primary rated current I_{pn} : 0...(200...1600) A
- Round conductor dimensions: \varnothing 52 mm
- Rail dimensions: 60x15 mm; 2x 50x10 mm; 40x40 mm

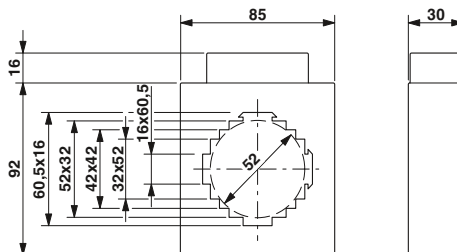

Plug-in curr. transformer, official calibration as an option

Notes:
 Our configurator, which is available at www.phoenixcontact.net/products, makes ordering easy.
 Current transformers that support official calibration: To specify the type of current transformer you require, please use the order key on page 224
 The relevant installation accessories can be found on page 223

Description		Rated power S_n	Ordering data		
Preferred versions available from stock (marked in green in the selection table)			Type	Order No.	Pcs. / Pkt.
Primary rated current I_{pn} :					
- 200 A		2.5 VA	PACT MCR-V2-6015- 85- 200-5A-1	2277873	1
- 250 A		2.5 VA	PACT MCR-V2-6015- 85- 250-5A-1	2277886	1
- 300 A		2.5 VA	PACT MCR-V2-6015- 85- 300-5A-1	2277899	1
- 400 A		2.5 VA	PACT MCR-V2-6015- 85- 400-5A-1	2277909	1
- 500 A		5 VA	PACT MCR-V2-6015- 85- 500-5A-1	2277912	1
- 600 A		10 VA	PACT MCR-V2-6015- 85- 600-5A-1	2277925	1
- 750 A		10 VA	PACT MCR-V2-6015- 85- 750-5A-1	2277938	1
- 800 A		10 VA	PACT MCR-V2-6015- 85- 800-5A-1	2277941	1
- 1000 A		15 VA	PACT MCR-V2-6015- 85-1000-5A-1	2277954	1
- 1250 A		15 VA	PACT MCR-V2-6015- 85-1250-5A-1	2277967	1
- 1500 A		15 VA	PACT MCR-V2-6015- 85-1500-5A-1	2277970	1
- 1600 A		15 VA	PACT MCR-V2-6015- 85-1600-5A-1	2277983	1
Current transformers , pay attention to the following order key for determining the desired current transformer type					
PACT MCR-V2- 6015- 85				2277336	1
Accessories					
Quick-action mechanism; width of the holding latch 16 mm					
Fixing pin length 40 mm			PACT-FAST-MNT-W16-L40	2276638	1
Quick-action mechanism; width of the holding latch 16 mm					
Fixing pin length 65 mm			PACT-FAST-MNT-W16-L65	2276641	1

Add order key from the selection table (ordering example marked in orange)

Order No.	Primary current I_{pn}	Secondary current I_{sn}	Class	Rated power S_n
2277336	IP05000	IS01	C10	P375

Selection table PACT MCR-V2-6015-85 (Order No.: 2277336)

I_{sn}	Cl.	Primary rated current amperage I_{pn} [A]											Rated power S_n [VA]	
		200	250	300	400	500	600	750	800	1000	1250	1500		1600
IS01 \cong 1 A	C05 \cong 0.5		1.25	1.25	1.25	2.5	2.5	2.5	2.5	2.5	5	5	5	5
	C10 \cong 1	2.5	2.5	2.5	2.5	3.75	2.5	2.5	2.5	2.5	2.5	5	5	5
IS05 \cong 5 A	C05 \cong 0.5		1.25	1.25	1.25	2.5	2.5	2.5	2.5	2.5	5	5	5	5
	C10 \cong 1	2.5	2.5	2.5	2.5	5	5	5	5	5	10	10	10	10

Monitoring

Current transformers

Current transformers

PACT MCR-V2-6315-95

- Primary rated current I_{pn} : 0...(200...2500) A
- Round conductor dimensions: \varnothing 53 mm
- Rail dimensions:
63x15 mm
2x 50x10 mm
40x40 mm



Plug-in curr. transformer, official calibration as an option

PACT MCR-V2-6040-96

- Primary rated current I_{pn} : 0...(200...2000) A
- Round conductor dimensions: \varnothing 61 mm
- Rail dimensions:
60x40 mm; 50x50 mm



Plug-in curr. transformer, official calibration as an option

Notes:
Our configurator, which is available at www.phoenixcontact.net/products, makes ordering easy.
Current transformers that support official calibration: To specify the type of current transformer you require, please use the order key on page 225
The relevant installation accessories can be found on page 223

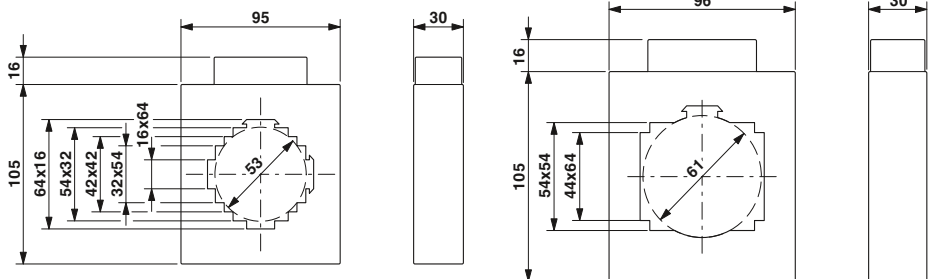

Description	Rated power S_n
Preferred versions available from stock (marked in green in the selection table) Primary rated current I_{pn} :	
- 600 A	10 VA
- 750 A	10 VA
- 800 A	10 VA
- 1000 A	10 VA
- 1250 A	10 VA
- 1250 A	15 VA
- 1500 A	10 VA
- 1600 A	10 VA
- 1600 A	15 VA
- 2000 A	15 VA
Current transformers , pay attention to the following order key for determining the desired current transformer type	

Ordering data		
Type	Order No.	Pcs. / Pkt.
PACT MCR-V2-6315-95-800-5A-1	2277213	1
PACT MCR-V2-6315-95-1000-5A-1	2277226	1
PACT MCR-V2-6315-95-1250-5A-1	2277239	1
PACT MCR-V2-6315-95-1500-5A-1	2277242	1
PACT MCR-V2-6315-95-1600-5A-1	2277255	1
PACT MCR-V2- 6315- 95	2277307	1

Ordering data		
Type	Order No.	Pcs. / Pkt.
PACT MCR-V2-6040-96-600-5A-1	2276191	1
PACT MCR-V2-6040-96-750-5A-1	2276201	1
PACT MCR-V2-6040-96-800-5A-1	2276214	1
PACT MCR-V2-6040-96-1000-5A-1	2277705	1
PACT MCR-V2-6040-96-1250-5A-1	2276227	1
PACT MCR-V2-6040-96-1500-5A-1	2277718	1
PACT MCR-V2-6040-96-1600-5A-1	2276230	1
PACT MCR-V2-6040-96-2000-5A-1	2276243	1
PACT MCR-V2- 6040- 96	2277349	1

Quick-action mechanism; width of the holding latch 16 mm
Fixing pin length 40 mm
Quick-action mechanism; width of the holding latch 16 mm
Fixing pin length 65 mm

Accessories		
Type	Order No.	Pcs. / Pkt.
PACT-FAST-MNT-W16-L40	2276638	1
PACT-FAST-MNT-W16-L65	2276641	1

Add **order key** from the selection table (ordering example marked in orange)

Order No.	Primary current I_{pn}	Secondary current I_{sn}	Class	Rated power S_n
2277307	IP25000	IS05	C05	P500

Selection table PACT MCR-V2-6315-95 (Order No.: 2277307)

I_{sn}	Cl.	Primary rated current amperage I_{pn} [A]													Rated power S_n [VA]		
		200	250	300	400	500	600	750	800	1000	1250	1500	1600	2000		2500	
IS01 \cong 1 A	C05 \cong 0.5	2.5	2.5	2.5	2.5	2.5	2.5	5	5	5	5	5	5	5	5	5	10
	C10 \cong 1	3.75	5	5	5	5	5	10	10	10	10	10	10	10	10	15	20
IS05 \cong 5 A	C05 \cong 0.5	2.5	2.5	2.5	2.5	2.5	2.5	5	5	5	5	5	5	5	5	5	10
	C10 \cong 1	3.75	5	5	5	5	5	10	10	10	10	10	10	10	10	15	20

Selection table PACT MCR-V2-6040-96 (Order No.: 2277349)

I_{sn}	Cl.	Primary rated current amperage I_{pn} [A]													Rated power S_n [VA]		
		200	250	300	400	500	600	750	800	1000	1250	1500	1600	2000			
IS01 \cong 1 A	C05 \cong 0.5	2.5	2.5	2.5	2.5	2.5	2.5	5	5	5	5	5	5	5	5	5	10
	C10 \cong 1	3.75	5	5	5	5	5	10	10	10	10	10	10	10	10	15	20
IS05 \cong 5 A	C05 \cong 0.5	2.5	2.5	2.5	2.5	2.5	2.5	5	5	5	5	5	5	5	5	5	10
	C10 \cong 1	3.75	3.75	5	5	5	5	10	10	10	10	10	10	10	10	15	20

Current transformers

PACT MCR-V2-8015-105

- Primary rated current I_{pn} : 0...(400...2500) A
- Round conductor dimensions: \varnothing 61 mm
- Rail dimensions: 80x15 mm; 2x 60x10 mm; 3x 50x10 mm

PACT MCR-V2-8020-105

- Primary rated current I_{pn} : 0...(500...2000) A
- Round conductor dimensions: \varnothing 70 mm
- Rail dimensions: 2x 80x10 mm; 60x60 mm



Plug-in curr. transformer, official calibration as an option



Plug-in curr. transformer, official calibration as an option

Notes:
 Our configurator, which is available at www.phoenixcontact.net/products, makes ordering easy.
 Current transformers that support official calibration: To specify the type of current transformer you require, please use the order key on page 225
 The relevant installation accessories can be found on page 223

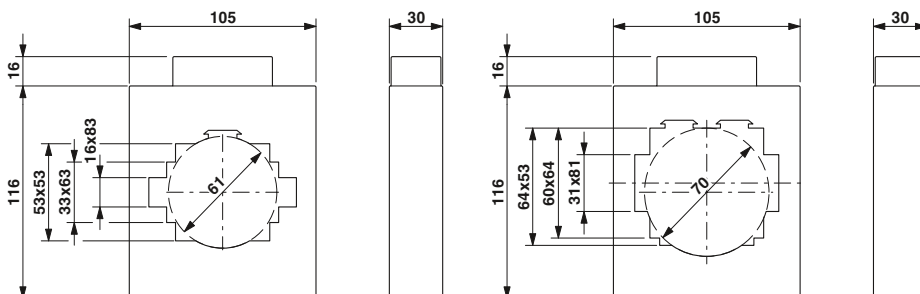

Description	Rated power S_n
Preferred versions available from stock (marked in green in the selection table)	
Primary rated current I_{pn} :	
- 400 A	7.5 VA
- 500 A	10 VA
- 600 A	10 VA
- 750 A	10 VA
- 800 A	15 VA
- 1000 A	10 VA
- 1000 A	15 VA
- 1250 A	10 VA
- 1500 A	15 VA
- 1600 A	15 VA
- 2000 A	10 VA
- 2000 A	20 VA
- 2500 A	20 VA
Current transformers , pay attention to the following order key for determining the desired current transformer type	

Ordering data		
Type	Order No.	Pcs. / Pkt.
PACT MCR-V2-8015-105- 400-5A-1	2276256	1
PACT MCR-V2-8015-105- 500-5A-1	2276269	1
PACT MCR-V2-8015-105- 600-5A-1	2276272	1
PACT MCR-V2-8015-105- 750-5A-1	2276285	1
PACT MCR-V2-8015-105- 800-5A-1	2276298	1
PACT MCR-V2-8015-105-1000-5A-1	2277721	1
PACT MCR-V2-8015-105-1000-5A-1	2276308	1
PACT MCR-V2-8015-105-1250-5A-1	2276311	1
PACT MCR-V2-8015-105-1500-5A-1	2277734	1
PACT MCR-V2-8015-105-1600-5A-1	2276324	1
PACT MCR-V2-8015-105-2000-5A-1	2276337	1
PACT MCR-V2-8015-105-2500-5A-1	2276340	1
PACT MCR-V2- 8015-105	2277352	1

Ordering data		
Type	Order No.	Pcs. / Pkt.
PACT MCR-V2-8020-105-1000-5A-1	2277747	1
PACT MCR-V2-8020-105-1500-5A-1	2277750	1
PACT MCR-V2-8020-105-2000-5A-1	2276382	1
PACT MCR-V2- 8020-105	2277365	1

Add **order key** from the selection table (ordering example marked in orange)

Order No.	Primary current I_{pn}	Secondary current I_{sn}	Class	Rated power S_n
2277352	IP25000	IS05	C10	P3000

Selection table PACT MCR-V2-8015-105 (Order No.: 2277352)

I_{sn}	Cl.	Primary rated current amperage I_{pn} [A]											Rated power S_n [VA]				
		400	500	600	750	800	1000	1250	1500	1600	2000	2500					
IS01 ≈ 1 A	C05 ≈ 0.5	2.5	2.5	2.5	2.5	2.5	2.5	2.5	2.5	2.5	2.5	2.5	5				
	C10 ≈ 1	5	5	5	5	5	5	5	5	5	5	5	10	15	20		
	C05 ≈ 0.5	2.5	2.5	2.5	2.5	2.5	2.5	2.5	2.5	2.5	2.5	2.5	5	10	15	20	25
IS05 ≈ 5 A	C05 ≈ 0.5	5	5	5	5	5	5	5	5	5	5	5	10	15	20		
	C10 ≈ 1	7.5	10	10	10	10	10	10	10	15	15	20	20	25	30		
	C05 ≈ 0.5	2.5	2.5	2.5	2.5	2.5	2.5	2.5	2.5	2.5	2.5	2.5	5	10	15	20	30

Selection table PACT MCR-V2-8020-105 (Order No.: 2277365)

I_{sn}	Cl.	Primary rated current amperage I_{pn} [A]									Rated power S_n [VA]						
		500	600	750	800	1000	1250	1500	1600	2000							
IS01 ≈ 1 A	C05 ≈ 0.5	2.5	2.5	2.5	2.5	2.5	2.5	2.5	2.5	2.5	5	5	5	5			
	C10 ≈ 1	5	5	5	5	5	5	5	5	5	10	10	10	15	20		
	C05 ≈ 0.5	2.5	2.5	2.5	2.5	2.5	2.5	2.5	2.5	2.5	2.5	2.5	2.5	2.5	2.5	5	
IS05 ≈ 5 A	C05 ≈ 0.5	5	5	5	5	5	5	5	5	5	5	5	5	5	5	5	
	C10 ≈ 1	7.5	7.5	7.5	7.5	10	10	10	10	10	10	10	10	15	15	20	
	C05 ≈ 0.5	2.5	2.5	2.5	2.5	2.5	2.5	2.5	2.5	2.5	2.5	2.5	2.5	2.5	2.5	5	

Monitoring

Current transformers

Current transformers

PACT MCR-V2-10020-129

- Primary rated current I_{pn} : 0...(400...4000) A
- Round conductor dimensions: \varnothing 85 mm
- Rail dimensions: 2x 100x10 mm; 80x64 mm

PACT MCR-V2-10036-129

- Primary rated current I_{pn} : 0...(400...4000) A
- Rail dimensions: 3x 100x12 mm



Plug-in curr. transformer, official calibration as an option



Plug-in curr. transformer, official calibration as an option

Notes:
 Our configurator, which is available at www.phoenixcontact.net/products, makes ordering easy.
 Current transformers that support official calibration: To specify the type of current transformer you require, please use the order key on page 225
 The relevant installation accessories can be found on page 223

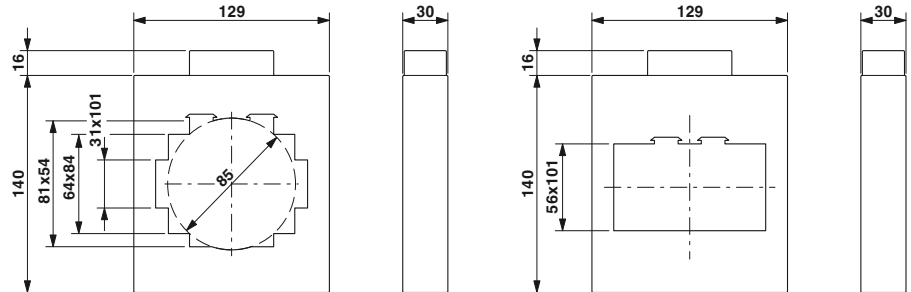

Description	Rated power S_n
Preferred versions available from stock (marked in green in the selection table) Primary rated current I_{pn} : - 2500 A - 3000 A	15 VA 15 VA
Current transformers , pay attention to the following order key for determining the desired current transformer type	

Ordering data		
Type	Order No.	Pcs. / Pkt.
PACT MCR-V2-10020-129-2500-5A	2276395	1
PACT MCR-V2-10020-129	2277378	1

Ordering data		
Type	Order No.	Pcs. / Pkt.
PACT MCR-V2-10036-129-3000-5A	2276405	1
PACT MCR-V2-10036-129	2277381	1

Add **order key** from the selection table (ordering example marked in orange)

Order No.	Primary current I_{pn}	Secondary current I_{sn}	Class	Rated power S_n
2277378	IP40000	IS05	C05	P2500

Selection table PACT MCR-V2-10020-129 (Order No.: 2277378)

I_{sn}	Cl.	Primary rated current amperage I_{pn} [A]												Rated power S_n [VA]								
		400	500	600	750	800	1000	1250	1500	1600	2000	2500	3000		4000							
IS01 ≥ 1 A	C05 ≥ 0.5		5	10	10	10	10	10	10	10	10	10	10	10	15	15	15	15	15	15	20	20
	C10 ≥ 1	2.5	2.5	5	5	5	5	5	5	5	5	5	5	5	5	5	5	5	5	5	25	30
IS05 ≥ 5 A	C05 ≥ 0.5		5	10	10	10	10	10	10	10	10	10	10	10	15	15	15	15	15	15	20	20
	C10 ≥ 1	2.5	2.5	5	5	5	5	5	5	5	5	5	5	5	5	5	5	5	5	5	25	30

Selection table PACT MCR-V2-10036-129 (Order No.: 2277381)

I_{sn}	Cl.	Primary rated current amperage I_{pn} [A]												Rated power S_n [VA]								
		400	500	600	750	800	1000	1250	1500	1600	2000	2500	3000		4000							
IS01 ≥ 1 A	C05 ≥ 0.5		5	10	10	10	10	10	10	10	10	10	10	10	15	15	15	15	15	15	20	20
	C10 ≥ 1	2.5	2.5	5	5	5	5	5	5	5	5	5	5	5	5	5	5	5	5	5	25	30
IS05 ≥ 5 A	C05 ≥ 0.5		5	10	10	10	10	10	10	10	10	10	10	10	15	15	15	15	15	15	20	20
	C10 ≥ 1	2.5	2.5	5	5	5	5	5	5	5	5	5	5	5	5	5	5	5	5	5	25	30

Current transformers

PACT MCR-V2-12020-159

- Primary rated current I_{pn} : 0...(400...4000) A
- Round conductor dimensions: \varnothing 96 mm
- Rail dimensions: 2x 120x10 mm; 3x 100x10 mm; 80x80 mm

PACT MCR-V2-12040-159

- Primary rated current I_{pn} : 0...(400...4000) A
- Rail dimensions: 4x 120x10 mm



Plug-in current transformer



Plug-in current transformer

Notes:
 Our configurator, which is available at www.phoenixcontact.net/products, makes ordering easy.
 The relevant installation accessories can be found on page 223

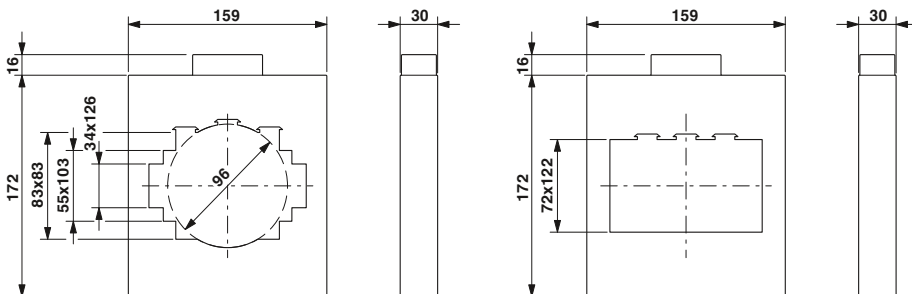

Description	Rated power S_n
Preferred versions available from stock (marked in green in the selection table) Primary rated current I_{pn} : - 4000 A	15 VA
Current transformers , pay attention to the following order key for determining the desired current transformer type	

Ordering data		
Type	Order No.	Pcs. / Pkt.
PACT MCR-V2-12020-159	2277394	1

Ordering data		
Type	Order No.	Pcs. / Pkt.
PACT MCR-V2-12040-159-4000-5A	2276418	1
PACT MCR-V2-12040-159	2277404	1

Add **order key** from the selection table (ordering example marked in orange)

Order No.	Primary current I_{pn}	Secondary current I_{sn}	Class	Rated power
2277404	IP08000	IS01	C05	P250

Selection table PACT MCR-V2-12020-159 (Order No.: 2277394)

I_{sn}	Cl.	Primary rated current amperage I_{pn} [A]												Rated power S_n [VA]		
		400	500	600	750	800	1000	1250	1500	1600	2000	2500	3000		4000	
IS01 ≅ 1A	C05 ≅ 0.5	2.5	2.5	2.5	2.5	2.5	2.5	5	5	5	5	5	5	10	15 VA	
		5	5	5	5	5	5	10	10	10	10	10	10	15		
	10	10	10	10	10	10	15	15	15	15	15	15	30			
	15	15	15	15	15	15	20	20	20	20	20	20	45			
C10 ≅ 1	2.5	5	5	2.5	2.5	5	5	5	5	5	5	5	10	10		
	5	10	10	5	5	10	10	10	10	10	10	10	15	15		
IS05 ≅ 5 A	C05 ≅ 0.5	2.5	2.5	2.5	2.5	2.5	5	5	5	5	5	5	5	10		10
		5	5	5	5	5	10	10	10	10	10	10	10	15		15
	10	10	10	10	10	15	15	15	15	15	15	15	30	30		
	15	15	15	15	15	20	20	20	20	20	20	20	45	45		
C10 ≅ 1	2.5	5	5	5	5	5	10	10	10	10	10	10	15	15		
	5	10	10	10	10	10	15	15	15	15	15	15	30	30		
C10 ≅ 1	10	15	15	15	15	15	15	30	30	30	30	30	45	45		
	15	20	20	20	20	20	30	30	30	30	30	30	45	45		

Selection table PACT MCR-V2-12040-159 (Order No.: 2277404)

I_{sn}	Cl.	Primary rated current amperage I_{pn} [A]												Rated power S_n [VA]		
		400	500	600	750	800	1000	1250	1500	1600	2000	2500	3000		4000	
IS01 ≅ 1A	C05 ≅ 0.5	2.5	2.5	2.5	2.5	2.5	5	5	5	5	5	5	5	10	10	15 VA
		5	5	5	5	5	5	10	10	10	10	10	10	15	15	
	10	10	10	10	10	10	15	15	15	15	15	15	30	30		
	15	15	15	15	15	15	20	20	20	20	20	20	45	45		
C10 ≅ 1	2.5	5	5	2.5	2.5	5	5	5	5	5	5	5	10	10		
	5	10	10	5	5	10	10	10	10	10	10	10	15	15		
IS05 ≅ 5 A	C05 ≅ 0.5	2.5	2.5	2.5	2.5	2.5	5	5	5	5	5	5	5	10	10	
		5	5	5	5	5	10	10	10	10	10	10	10	15	15	
	10	10	10	10	10	15	15	15	15	15	15	15	30	30		
	15	15	15	15	15	20	20	20	20	20	20	20	45	45		
C10 ≅ 1	2.5	5	5	5	5	5	10	10	10	10	10	10	15	15		
	5	10	10	10	10	10	15	15	15	15	15	15	30	30		
C10 ≅ 1	10	15	15	15	15	15	15	30	30	30	30	30	45	45		
	15	20	20	20	20	20	30	30	30	30	30	30	45	45		

Monitoring

Current transformers

Current transformers

PACT MCR-V3-60

– Primary rated current I_{pn} :
0...(1...40) A

– Current-carrying copper lines connected directly to the screw terminal blocks on the primary side

Notes:
Our configurator, which is available at www.phoenixcontact.net/products, makes ordering easy.
The relevant installation accessories can be found on page 223

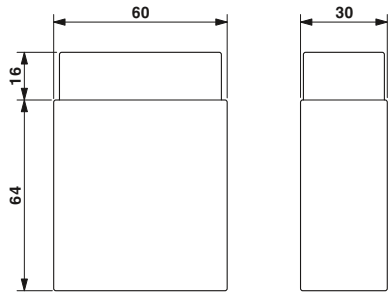

Winding current transformer

Ordering data		
Type	Order No.	Pcs. / Pkt.
PACT MCR-V3-60	2277417	1

Description
Current transformers, pay attention to the following order key for determining the desired current transformer type

Add order key from the selection table (ordering example marked in orange)

Order No.	Primary current I_{pn}	Secondary current I_{sn}	Class	Rated power S_n
2277417	IP00025	IS01	C10	P250

Selection table PACT MCR-V3-60 (Order No.: 2277417)

I_{sn}	Cl.	Primary rated current strength I_{pn} [A]														Rated power S_n [VA]
		1	2	2.5	4	5	6	7.5	10	12.5	15	20	25	30	40	
$\cong 1$ A	C05 $\cong 0.5$	2.5	2.5	2.5	2.5	2.5	2.5	2.5	2.5	2.5	2.5	2.5	2.5	2.5	2.5	250
		5	5	5	5	5	5	5	5	5	5	5	5	5	5	
	C10 $\cong 1$	2.5	2.5	2.5	2.5	2.5	2.5	2.5	2.5	2.5	2.5	2.5	2.5	2.5	2.5	
		5	5	5	5	5	5	5	5	5	5	5	5	5	5	
$\cong 5$ A	C05 $\cong 0.5$	2.5	2.5	2.5	2.5	2.5	2.5	2.5	2.5	2.5	2.5	2.5	2.5	2.5	2.5	250
		5	5	5	5	5	5	5	5	5	5	5	5	5	5	
	C10 $\cong 1$	2.5	2.5	2.5	2.5	2.5	2.5	2.5	2.5	2.5	2.5	2.5	2.5	2.5	2.5	
		5	5	5	5	5	5	5	5	5	5	5	5	5	5	

Quick-action mechanism for PACT current transformers

- No tools necessary for mounting
- Extremely easy handling, thanks to secure fastening by pressing with finger
- Set consisting of two fixing pins and a holding latch

Notes:

The 16 mm wide quick-action mechanism can also be used for larger current transformers if the length of the fixing pins is sufficient.



for: ...V2-4012-70..., ...V2-5012-85...



for: ...V2-3015-60..., ...V2-6015-85..., ...V2-6315-95...

Technical data

Material	PA 6
Ambient temperature (operation)	-25°C ... 120°C

Ordering data

Type	Order No.	Pcs. / Pkt.
PACT-FAST-MNT-W13-L65	2276625	1
PACT-FAST-MNT-W13-L40	2276612	1

Technical data

Material	PA 6
Ambient temperature (operation)	-25°C ... 120°C

Ordering data

Type	Order No.	Pcs. / Pkt.
PACT-FAST-MNT-W16-L65	2276641	1
PACT-FAST-MNT-W16-L40	2276638	1

General data

Material	PA 6
Ambient temperature (operation)	-25°C ... 120°C

Description

Quick-action mechanism; width of the holding latch 13 mm

Fixing pin length 65 mm
Fixing pin length 40 mm

Quick-action mechanism; width of the holding latch 16 mm

Fixing pin length 65 mm
Fixing pin length 40 mm

Accessories

- Copper sleeves
- DIN rail adapter
- Secondary terminal cover
- Insulating caps



Copper sleeves
DIN rail adapter



Secondary terminal cover
Insulating caps

Ordering data

Type	Order No.	Pcs. / Pkt.
PACT MCR-CB-21- 8	2277569	1
PACT MCR-CB-21-12	2277556	1
PACT MCR-CB-28-12	2277543	1
PACT MCR-CB-42-12	2277530	1
PACT MCR-RA	2277598	12

Ordering data

Type	Order No.	Pcs. / Pkt.
PACT MCR-ETC-60	2277572	9
PACT MCR-ETC-75	2277585	9
PACT MCR-ICAP	2277608	18

Description

Copper sleeves, for establishing a conductive connection during the horizontal assembly of PACT analog current transformers. The size of the copper sleeve depends on the diameter of the inner hole of the current transformer.

- for PACT MCR-V1-21-44-... Ø 21/8 mm
- for PACT MCR-V1-21-44-... Ø 21/12 mm
- for PACT MCR-V2-3015-60-... Ø 28/12 mm
- for PACT MCR-V2-5012-85-... Ø 42/12 mm

DIN rail adapter

Secondary terminal cover, for increasing the clearances and creepage distances

Length: 60 mm
Length: 75 mm

Insulating caps, for protection against unintended contact with mounting screws of the primary rail

Current transformers

Calibratable current transformers - order key and selection tables

Add **order key** from the relevant selection table (ordering examples are marked in orange)

Order No.	Primary current I_{pn}	Secondary current I_{sn}	Class	Rated power S_n	Calibration	Calibration certificate
	IP01500 ≙ 150 A IP02000 ≙ 200 A IP02500 ≙ 250 A IP03000 ≙ 300 A IP04000 ≙ 400 A IP05000 ≙ 500 A IP06000 ≙ 600 A IP07500 ≙ 750 A IP08000 ≙ 800 A IP10000 ≙ 1000 A IP12000 ≙ 1200 A IP12500 ≙ 1250 A IP15000 ≙ 1500 A IP16000 ≙ 1600 A IP20000 ≙ 2000 A IP25000 ≙ 2500 A	IS05 ≙ 5 A	C02S ≙ 0.2S C02 ≙ 0.2 C05S ≙ 0.5S C05 ≙ 0.5	P250 ≙ 2.5 VA P500 ≙ 5.0 VA P1000 ≙ 10 VA P1500 ≙ 15 VA P2000 ≙ 20 VA P3000 ≙ 30 VA	NONE ≙ not calibrated YES ≙ calibrated	NONE ≙ no calibration certificate YES ≙ calibration certificate (a fee is charged) YESPLUS ≙ Calibration certificate with catalog of errors (5 measuring points) (a fee is charged)

PACT MCR-V1C-21-44 (Order No.: 2277420)

You will find information about the product on page 213.

Add **order key** from the selection table

2277420 / IP03000 / IS05 / C02 / P250 / NONE / NONE

Selection table

I_{sn}	Cl.	Primary rated current amperage I_{pn} [A]						Rated power S_n [VA]
		150	200	250	300	400	500	
IS05 ≙ 5 A	C02S ≙ 0.2S					2.5	2.5	5
	C02 ≙ 0.2			2.5	2.5	2.5	2.5	5
IS05 ≙ 5 A	C05S ≙ 0.5S	2.5	2.5	2.5	2.5	2.5	2.5	10
	C05 ≙ 0.5	2.5	2.5	2.5	2.5	2.5	2.5	10

PACT MCR-V2C-3015-60 (Order No.: 2277433)

You will find information about the product on page 214.

Add **order key** from the selection table

2277433 / IP02000 / IS05 / C05 / P250 / NONE / NONE

Selection table

I_{sn}	Cl.	Primary rated current amperage I_{pn} [A]							Rated power S_n [VA]
		200	250	300	400	500	600	750	
IS05 ≙ 5 A	C02S ≙ 0.2S						2.5	2.5	5
	C02 ≙ 0.2				2.5	2.5	2.5	2.5	5
IS05 ≙ 5 A	C05S ≙ 0.5S	2.5	2.5	2.5	2.5	2.5	2.5	2.5	15
	C05 ≙ 0.5	2.5	2.5	2.5	2.5	2.5	2.5	2.5	15

PACT MCR-V2C-4012-70 (Order No.: 2277446)

You will find information about the product on page 215.

Add **order key** from the selection table

2277446 / IP06000 / IS05 / C02 / P1000 / NONE / NONE

Selection table

I_{sn}	Cl.	Primary rated current amperage I_{pn} [A]								Rated power S_n [VA]	
		200	250	300	400	500	600	750	800		1000
IS05 ≙ 5 A	C02S ≙ 0.2S						2.5	2.5	2.5	5	5
	C02 ≙ 0.2				2.5	2.5	2.5	5	2.5	5	10
IS05 ≙ 5 A	C05S ≙ 0.5S	2.5	2.5	2.5	2.5	2.5	5	5	2.5	5	10
	C05 ≙ 0.5	2.5	2.5	2.5	2.5	2.5	5	5	2.5	5	10

PACT MCR-V2C-5012-85 (Order No.: 2277459)

You will find information about the product on page 216.

Add **order key** from the selection table

2277459 / IP10000 / IS05 / C05 / P1500 / NONE / NONE

Selection table

I_{sn}	Cl.	Primary rated current amperage I_{pn} [A]										Rated power S_n [VA]		
		200	250	300	400	500	600	750	800	1000	1200			
IS05 ≙ 5 A	C02S ≙ 0.2S						2.5	2.5	2.5	5	5	5	10	10
	C02 ≙ 0.2				2.5	2.5	2.5	2.5	2.5	5	5	10	10	15
IS05 ≙ 5 A	C05S ≙ 0.5S	2.5	2.5	2.5	2.5	2.5	5	5	5	5	5	10	10	15
	C05 ≙ 0.5	2.5	2.5	2.5	2.5	2.5	5	5	5	5	5	10	10	15

PACT MCR-V2C-6015-85 (Order No.: 2277462)

You will find information about the product on page 217.

Add **order key** from the selection table

2277462 / IP02500 / IS05 / C05 / P250 / NONE / NONE

Selection table

I_{sn}	Cl.	Primary rated current amperage I_{pn} [A]										Rated power S_n [VA]		
		250	300	400	500	600	750	800	1000	1200				
IS05 ≙ 5 A	C02S ≙ 0.2S						2.5	2.5	2.5	2.5	2.5	5	5	10
	C02 ≙ 0.2				2.5	2.5	2.5	2.5	2.5	5	5	10	10	15
IS05 ≙ 5 A	C05S ≙ 0.5S	2.5	2.5	2.5	2.5	2.5	5	5	5	5	5	10	10	15
	C05 ≙ 0.5	2.5	2.5	2.5	2.5	2.5	5	5	5	5	5	10	10	15

Calibratable current transformers - order key and selection tables

Add order key from the relevant selection table (ordering examples are marked in orange)

Order No., Primary current Ipn, Secondary current Isn, Class, Rated power Sn, Calibration, Calibration certificate

PACT MCR-V2C-6315-95 (Order No.: 2277475)

You will find information about the product on page 218.

Add order key from the selection table

Order key: 2277475 / IP15000 / IS05 / C05 / P3000 / NONE / NONE

Selection table

Table with columns Isn, Cl., Primary rated current amperage Ipn [A], and Rated power Sn [VA]

PACT MCR-V2C-6040-96 (Order No.: 2277488)

You will find information about the product on page 218.

Add order key from the selection table

Order key: 2277488 / IP12000 / IS05 / C02 / P1000 / NONE / NONE

Selection table

Table with columns Isn, Cl., Primary rated current amperage Ipn [A], and Rated power Sn [VA]

PACT MCR-V2C-8015-105 (Order No.: 2277491)

You will find information about the product on page 219.

Add order key from the selection table

Order key: 2277491 / IP05000 / IS05 / C05 / P500 / NONE / NONE

Selection table

Table with columns Isn, Cl., Primary rated current amperage Ipn [A], and Rated power Sn [VA]

PACT MCR-V2C-8020-105 (Order No.: 2277501)

You will find information about the product on page 219.

Add order key from the selection table

Order key: 2277501 / IP15000 / IS05 / C05S / P1000 / NONE / NONE

Selection table

Table with columns Isn, Cl., Primary rated current amperage Ipn [A], and Rated power Sn [VA]

PACT MCR-V2C-10020-129 (Order No.: 2277514)

You will find information about the product on page 220.

Add order key from the selection table

Order key: 2277514 / IP08000 / IS05 / C05 / P1500 / NONE / NONE

Selection table

Table with columns Isn, Cl., Primary rated current amperage Ipn [A], and Rated power Sn [VA]

PACT MCR-V2C-10036-129 (Order No.: 2277527)

You will find information about the product on page 220.

Add order key from the selection table

Order key: 2277527 / IP16000 / IS05 / C05 / P500 / NONE / NONE

Selection table

Table with columns Isn, Cl., Primary rated current amperage Ipn [A], and Rated power Sn [VA]



With flexible power supply – current transducers up to 12 A AC

Active current transducers convert sinusoidal alternating currents up to 12 A. The integrated wide-range power supply unit enables use in various different countries.

With hinged Rogowski sensor – current transducers up to 200 A AC

The AC current transducers measure sinusoidal and non-sinusoidal alternating currents up to 200 A. The hinged Rogowski sensor ensures very easy installation, as cables that are to be measured do not have to be isolated. This enables mounting to be carried out without interruptions.

Limit value monitoring with the current protector

At the current protector, a desired amperage is specified at which a PDT contact switches a load on or off.

Flexible signal conditioning – current transducers up to 55 A AC/DC

Current transducers up to 55 A offer an infinitely adjustable measuring range. This range is mapped over the entire output signal range. This ensures extremely accurate resolution of measured values. Basic configuration can be performed quickly via the DIP switches. Additional useful device functions can be set via the software.

For high currents – current transducers up to 600 A AC/DC

The universal current transducers are the ideal solution for measuring high currents with any waveform up to 600 A AC/DC. The product range offers various different devices in graded measuring ranges with current or voltage output.

Voltage transducers, AC and DC

Voltage transducers convert AC and DC voltages into standard analog signals.



For sinusoidal alternating currents up to 12 A

- 3-way electrical isolation
- Wide-range version from 19.2 ... 253 V AC/DC
- Voltage bridging with DIN rail connector
- Input/output can be configured via DIP switches
- Suitable for potentially explosive areas, thanks to ATEX approval for Ex zone 2



For sinusoidal and non-sinusoidal alternating currents up to 200 A

- Distorted alternating currents up to 6000 Hz can be also acquired, thanks to true r.m.s. value measurement (RMS)
- Uninterrupted installation and lossless current measurement thanks to hinged Rogowski sensor
- Measuring range selection with slide switch



Limit value monitoring

- The current protector converts sinusoidal alternating currents to binary switching signals.
- Switching point can be freely selected in the measuring range of 0 ... 16 A AC
 - Changeover relay output
 - Adjustable switch hysteresis
 - 3-way isolation
 - Settable operating current/quiescent current behavior



With flexible measuring ranges for all waveforms up to 55 A

- Lossless true r.m.s. value measurement without shunt via Hall sensor (TRMS)
- Optimum mapping of the measuring range up to 55 A, thanks to software-programmable upper and lower limits
- Limit value alarm in the event of threshold value overrange or underrange up to 55 A
 - via relay or transistor output



For high currents – current transducers up to 600 A AC/DC

- Lossless true r.m.s. value measurement without shunt via Hall sensor (TRMS)
- Compact dimensions also enable distributed use
- Variable mounting on DIN rail and mounting plate
- COMBICON plug-in connection terminal blocks
- 3-way isolation
- For a conductor diameter of up to 32 mm



Voltage transducers, AC and DC

- For DC voltages from 0 ... ± 660 V DC and AC voltages from 0 ... 444 V AC
- Bidirectional output signals
- Adjustable voltage ranges
- ZERO/SPAN adjustment $\pm 20\%$
- 3-way isolation

Current acquisition

If purely ohmic loads (incandescent lamps, heaters, etc.) are operated on a conventional 230 V network, no distortions are produced on the power grid.

As non-linear loads increase as a result of phase angle-controlled regulation modules, pure sinusoidal waves gradually take on a trapezoidal waveform.

The majority of current and voltage transducers are calibrated for sinusoidal alternating currents, which means that they can only indicate the r.m.s. value of an alternating current by mean-value generation.

True r.m.s. measuring transducers do not rely on specific form factors and accept all waveforms.

r.m.s. value acquisition according to the transformer principle (RMS)

According to Faraday's law of induction, a magnetic flux which changes over time produces an induced voltage at the terminals of a coil. A circuit arrangement consisting of two electrically isolated but magnetically coupled circuits is known as a transformer. This is one of the simplest and most commonly used methods of current transfer.

Mean-value generation

r.m.s. value (root mean square value)

The r.m.s. value of an alternating current corresponds to the steady-state value that results from the instantaneous values of this current. This steady-state value generates the same thermal work in an ohmic resistor as a direct current of identical magnitude.

The term "true r.m.s. value" simply means that distorted, direct, and pulsating currents can be acquired. Here, the measuring transducer is compatible with any waveform.

For a sinusoidal AC current this means:

$$I_{\text{rms}} = \frac{I_s}{\sqrt{2}} \quad U_r = \frac{U_s}{\sqrt{2}}$$

True r.m.s. value acquisition according to the Rogowski principle (TRMS)

The Rogowski measuring principle is used to measure sinusoidal and non-sinusoidal alternating currents. A non-ferrous induction coil (air-core coil), known as the Rogowski coil, measures the magnetic voltage along a closed circumference around a live conductor.

The output signal of the Rogowski coil is then conditioned so as to obtain an exact replica of the primary current.

True r.m.s. value acquisition with a Hall sensor (TRMS)

The magnetic flux generated by the primary current I_p is condensed in the magnetic circuit and measured in the air gap using a Hall sensor. The output signal of the Hall sensor is then conditioned so as to obtain an exact replica of the primary current.

Arithmetic average value

The arithmetic average value is used to measure direct currents or filter a DC component out from a pulsating current. Applying the arithmetic average value to a symmetrical alternating current would result in a measured value of "0".

The arithmetic average value enables direct currents to be made available at the output in the form of standard analog signals. The polarity can be evaluated by means of a bipolar output signal.

For a 230 V/50 Hz power grid, this results in the following with regard to the voltage levels:

$$U_{\text{rms}} = 230 \text{ V}$$

$$U_s = 325 \text{ V}$$

$$U_{\text{avg}} = 0 \text{ V}$$

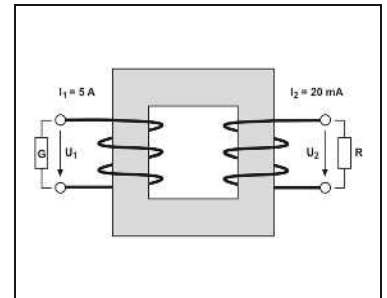

r.m.s. value acquisition according to the transformer principle (RMS)

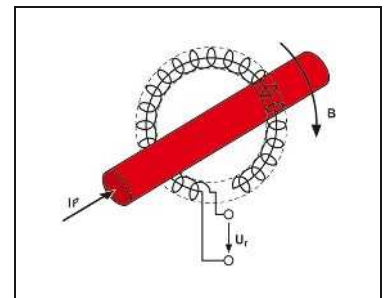

True r.m.s. value acquisition according to the Rogowski principle (TRMS)

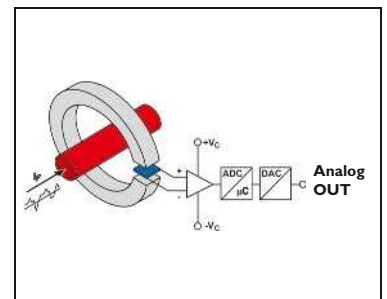

True r.m.s. value acquisition with a Hall sensor (TRMS)

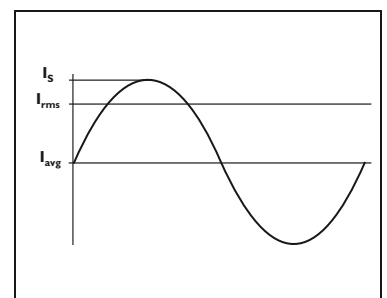

Arithmetic average value

AC/DC current transducers and distorted currents

The **MCR-SL-CUC-...** current transducers measure DC, AC, and distorted currents of 0 ... 600 A.

- Universal current measurement, no shunt required
- Compact dimensions also enable distributed use
- Variable mounting on DIN rail and mounting plate
- Simple connection method thanks to COMBICON plug-in connection terminal blocks
- 3-way isolation



For DC, AC, and distorted currents of 0 ... 300 A, voltage output



For DC, AC, and distorted currents of 0 ... 600 A, current output

Housing width 90 mm

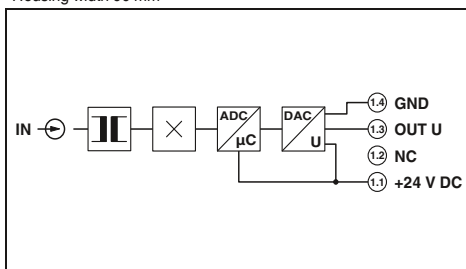

Technical data

Input data	
Frequency range	20 Hz ... 6000 Hz (0 Hz)
Curve type	AC, DC or distorted currents
Connection method	Cable design: 32 mm diameter
Output data	
Output signal	0 ... 10 V
Maximum output signal	
Load R_b	$\geq 10\text{ k}\Omega$
General data	
Supply voltage U_b	20 V DC ... 30 V DC
Maximum transmission error	$\leq \pm 1\%$ (of final value)
Temperature coefficient	typ. 0.02%/K (0 ... 60°C) 0.04%/K (-40 ... 65°C)
Step response (10 - 90%)	150 ms
Safe isolation	acc. to EN 61010
Rated insulation voltage	300 V AC
Surge voltage category / pollution degree	III / 2
Degree of protection	IP20
Ambient temperature range	-40°C ... 65°C
Dimensions W / H / D	90 / 33.8 / 85 mm
Spring-cage connection (solid/stranded/AWG)	0.25 ... 2.5 mm ² / 0.2 ... 2.5 mm ² / 24 - 12
Conformance / approvals	
Conformance	CE-compliant
UL, USA / Canada	UL/C-UL listed UL 508

Housing width 90 mm

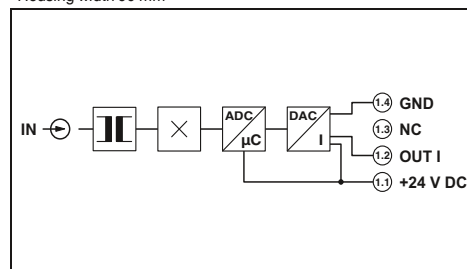

Technical data

Input data	
Frequency range	20 Hz ... 6000 Hz (0 Hz)
Curve type	AC, DC or distorted currents
Connection method	Cable design: 32 mm diameter
Output data	
Output signal	4 ... 20 mA
Maximum output signal	$< 25\text{ mA}$
Load R_b	$< 300\ \Omega$
General data	
Supply voltage U_b	20 V DC ... 30 V DC
Maximum transmission error	$\leq \pm 1\%$ (of final value)
Temperature coefficient	typ. 0.02%/K (0 ... 60°C) 0.04%/K (-40 ... 65°C)
Step response (10 - 90%)	150 ms
Safe isolation	acc. to EN 61010
Rated insulation voltage	300 V AC
Surge voltage category / pollution degree	III / 2
Degree of protection	IP20
Ambient temperature range	-40°C ... 65°C
Dimensions W / H / D	90 / 33.8 / 85 mm
Spring-cage connection (solid/stranded/AWG)	0.25 ... 2.5 mm ² / 0.2 ... 2.5 mm ² / 24 - 12
Conformance / approvals	
Conformance	CE-compliant
UL, USA / Canada	UL/C-UL listed UL 508

Ordering data

Type	Order No.	Pcs. / Pkt.
MCR-SL-CUC-100-U	2308108	1
MCR-SL-CUC-200-U	2308205	1
MCR-SL-CUC-300-U	2308302	1

Ordering data

Type	Order No.	Pcs. / Pkt.
MCR-SL-CUC-100-I	2308027	1
MCR-SL-CUC-200-I	2308030	1
MCR-SL-CUC-300-I	2308043	1
MCR-SL-CUC-400-I	2308072	1
MCR-SL-CUC-500-I	2308085	1
MCR-SL-CUC-600-I	2308098	1

Description	Overload capacity
Universal current transducer	
Input current range: 0 ... 100 A	6 x I_{IN}
Input current range: 0 ... 200 A	3 x I_{IN}
Input current range: 0 ... 300 A	3.33 x I_{IN}
Input current range: 0 ... 400 A	2.5 x I_{IN}
Universal current transducer without UL approval	
Input current range: 0 ... 500 A	3.6 x I_{IN}
Input current range: 0 ... 600 A	3 x I_{IN}

Monitoring

Current and voltage measuring technology

AC/DC current transducers and distorted currents

The **MCR-S...-UI(-SW)-DCI** current transducers measure direct, alternating and distorted currents.

- Device can be set via DIP switches or MCR/PI-CONF-WIN configuration software
- True r.m.s. value measurement
- 3-way isolation
- With optional relay and transistor output



For DC, AC, and distorted currents
0 ... 11 A



For DC, AC, and distorted currents
0 ... 55 A

Notes:

To order a configurable product, enter the required configuration by referring to the adjacent order key.

Further information about the configuration software can be found on page 237

1) EMC: Class A product, see page 571



Ex: Housing width 22.5 mm

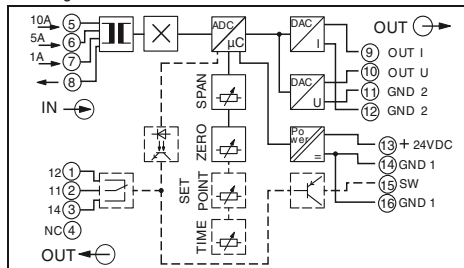

Ex: Housing width 22.5 mm

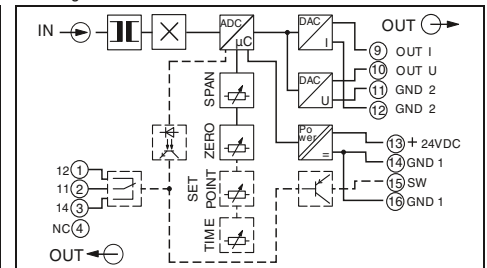

Input data		
Input current	0 A ... 11 A (AC/DC)	
Operate threshold	2% (of measuring range nominal value 1/5/10 A)	
Frequency range	15 Hz ... 400 Hz	
Curve type	AC, DC or distorted currents	
Overload capacity	2 x I _N (continuous)	
Surge strength	20 x I _N (1 s)	
Connection method	Screw connection	
Output data		
Output signal (normal and inverse)	U output: 0 ... 5 V / 1 ... 5 V / 0 ... 10 V I output: 0 ... 20 mA / 4 ... 20 mA	
Load R _B	> 10 kΩ	
Switching output	< 500 Ω	
Relay output	Contact material: 1 PDT / AgSnO, hard gold-plated Max. switching current: 50 mA (for gold layer, 30 V AC/36 V DC) 2 A (in case of a destroyed gold layer, 250 V AC) 19 V ... 29 V (supply voltage - 1 V)	
Transistor output pnp	Output voltage: 80 mA (Not short-circuit proof) Continuous load current: 1% ... 110%	
Setting range of the threshold value	0.1 s ... 20 s	
Response delay	Yellow LED	
Status indication	General data	
Supply voltage U _B	20 V DC ... 30 V DC	
Current consumption	< 50 mA (without load)	
Maximum transmission error	< 0.5% (of nominal range value under nominal conditions)	
Temperature coefficient	typ. < 0.025%/K	
Step response (10 - 90%)	330 ms (with AC) 40 ms (with DC)	
Safe isolation	as per EN 50178, EN 61010	
Rated insulation voltage	300 V AC (to ground)	
Surge voltage category / pollution degree	III / 2	
Test voltage input/output	4 kV (50 Hz, 1 min.)	
Test voltage input/power supply	4 kV (50 Hz, 1 min.)	
Test voltage output/power supply	500 V (50 Hz, 1 min.)	
Degree of protection	IP20	
Ambient temperature range	-20°C ... 60°C	
Dimensions W / H / D	22.5 / 99 / 114.5 mm	
Screw connection solid / stranded / AWG	0.2 ... 2.5 mm ² / 0.2 ... 2.5 mm ² / 24 - 14	
Conformance / approvals	CE-compliant	
Conformance	Class I, Zone 2, AEx nC IIC T6, Ex nC IIC T6	
UL, USA / Canada		

Technical data		
Input current	0 A ... 11 A (AC/DC)	
Operate threshold	2% (of measuring range nominal value 1/5/10 A)	
Frequency range	15 Hz ... 400 Hz	
Curve type	AC, DC or distorted currents	
Overload capacity	2 x I _N (continuous)	
Surge strength	20 x I _N (1 s)	
Connection method	Screw connection	
Output data		
Output signal (normal and inverse)	U output: 0 ... 5 V / 1 ... 5 V / 0 ... 10 V I output: 0 ... 20 mA / 4 ... 20 mA	
Load R _B	> 10 kΩ	
Switching output	< 500 Ω	
Relay output	Contact material: 1 PDT / AgSnO, hard gold-plated Max. switching current: 50 mA (for gold layer, 30 V AC/36 V DC) 2 A (in case of a destroyed gold layer, 250 V AC) 19 V ... 29 V (supply voltage - 1 V)	
Transistor output pnp	Output voltage: 80 mA (Not short-circuit proof) Continuous load current: 1% ... 110%	
Setting range of the threshold value	0.1 s ... 20 s	
Response delay	Yellow LED	
Status indication	General data	
Supply voltage U _B	20 V DC ... 30 V DC	
Current consumption	< 50 mA (without load)	
Maximum transmission error	< 0.5% (of nominal range value under nominal conditions)	
Temperature coefficient	typ. < 0.025%/K	
Step response (10 - 90%)	330 ms (with AC) 40 ms (with DC)	
Safe isolation	as per EN 50178, EN 61010	
Rated insulation voltage	300 V AC (to ground)	
Surge voltage category / pollution degree	III / 2	
Test voltage input/output	4 kV (50 Hz, 1 min.)	
Test voltage input/power supply	4 kV (50 Hz, 1 min.)	
Test voltage output/power supply	500 V (50 Hz, 1 min.)	
Degree of protection	IP20	
Ambient temperature range	-20°C ... 60°C	
Dimensions W / H / D	22.5 / 99 / 114.5 mm	
Screw connection solid / stranded / AWG	0.2 ... 2.5 mm ² / 0.2 ... 2.5 mm ² / 24 - 14	
Conformance / approvals	CE-compliant	
Conformance	Class I, Zone 2, AEx nC IIC T6, Ex nC IIC T6	
UL, USA / Canada		

Technical data		
Input current	0 A ... 55 A (AC/DC)	
Operate threshold	0.8% (of measuring range nominal value 50 A)	
Frequency range	15 Hz ... 400 Hz	
Curve type	AC, DC or distorted currents	
Overload capacity	Depending on through connected conductor	
Surge strength	Depending on through connected conductor	
Connection method	Through connection, diameter 10.5 mm	
Output data		
Output signal (normal and inverse)	U output: 0 ... 5 V / 1 ... 5 V / 0 ... 10 V I output: 0 ... 20 mA / 4 ... 20 mA	
Load R _B	> 10 kΩ	
Switching output	< 500 Ω	
Relay output	Contact material: 1 PDT / AgSnO, hard gold-plated Max. switching current: 50 mA (for gold layer, 30 V AC/36 V DC) 2 A (in case of a destroyed gold layer, 250 V AC) 19 V ... 29 V (supply voltage - 1 V)	
Transistor output pnp	Output voltage: 80 mA (Not short-circuit proof) Continuous load current: 1% ... 110%	
Setting range of the threshold value	0.1 s ... 20 s	
Response delay	Yellow LED	
Status indication	General data	
Supply voltage U _B	20 V DC ... 30 V DC	
Current consumption	< 50 mA (without load)	
Maximum transmission error	< 0.5% (of nominal range value under nominal conditions)	
Temperature coefficient	typ. < 0.025%/K	
Step response (10 - 90%)	330 ms (with AC) 40 ms (with DC)	
Safe isolation	as per EN 50178, EN 61010	
Rated insulation voltage	300 V AC (to ground)	
Surge voltage category / pollution degree	III / 2	
Test voltage input/output	4 kV (50 Hz, 1 min.)	
Test voltage input/power supply	4 kV (50 Hz, 1 min.)	
Test voltage output/power supply	500 V (50 Hz, 1 min.)	
Degree of protection	IP20	
Ambient temperature range	-20°C ... 60°C	
Dimensions W / H / D	22.5 / 99 / 114.5 mm	
Screw connection solid / stranded / AWG	0.2 ... 2.5 mm ² / 0.2 ... 2.5 mm ² / 24 - 14	
Conformance / approvals	CE-compliant	
Conformance	Class I, Zone 2, AEx nC IIC T6, Ex nC IIC T6	
UL, USA / Canada		

Description
MCR current measuring transducer for measuring AC, DC, and distorted currents with relay and transistor switching output
Configurable product
Standard product
Configurable product, without switching output
Standard product, without switching output

Ordering data		
Type	Order No.	Pcs. / Pkt.
MCR-S-1-5-UI-SW-DCI ⁽¹⁾	2814650	1
MCR-S-1-5-UI-SW-DCI-NC ⁽¹⁾	2814731	1
MCR-S-1-5-UI-DCI ⁽¹⁾	2814634	1
MCR-S-1-5-UI-DCI-NC ⁽¹⁾	2814715	1

Ordering data		
Type	Order No.	Pcs. / Pkt.
MCR-S-10-50-UI-SW-DCI ⁽¹⁾	2814663	1
MCR-S-10-50-UI-SW-DCI-NC ⁽¹⁾	2814744	1
MCR-S-10-50-UI-DCI ⁽¹⁾	2814647	1
MCR-S-10-50-UI-DCI-NC ⁽¹⁾	2814728	1

Order key for the current transducers (standard configuration entered as example)

Order No.	Measuring range: Start	End	Output	Threshold value	Suppression time	Operating behavior of relay and transistor	
2814634	0.00	5.00	OUT01				
2814650	0.00	5.00	OUT01	50	3.0	A	O
2814634 ≙ MCR-S-1-5-UI-DCI	Measuring range starting value is between 0.00...7.50 A	Measuring range final value between 0.2...11 A	OUT01 ≙ 0...20 mA OUT02 ≙ 4...20 mA OUT03 ≙ 0...10 V OUT04 ≙ 2...10 V OUT05 ≙ 0...5 V OUT06 ≙ 1...5 V OUT07 ≙ 20...0 mA OUT08 ≙ 20...4 mA OUT09 ≙ 10...0 V OUT10 ≙ 10...2V OUT11 ≙ 5...0 V OUT12 ≙ 5...1 V OUT13 ≙ -5...+5 V OUT14 ≙ -10...+10 V OUT17 ≙ +10...-10 V OUT18 ≙ +5...-5 V	Switching threshold between 1 ... 110% 50 ≙ 50% of set upper measuring range value (here: 2.5 A)	between 0.1 ... 20 s 3.0 ≙ 3 s	A ≙ Operating current controlled R ≙ Closed-circuit current controlled	O ≙ Overrange U ≙ Underrange
2814650 ≙ MCR-S-1-5-UI-SW-DCI	0.00 ≙ 0.00 A	5.00 ≙ 5.00 A					

Order No.	Measuring range: Start	End	Output	Threshold value	Suppression time	Operating behavior and transistor	
2814647	0.0	50.0	OUT01				
2814663	0.0	50.0	OUT01	50	3.0	A	O
2814647 ≙ MCR-S-10-50-UI-DCI	Measuring range start value is between 0.00...37.5 A	Measuring range final value between 9.5...55 A	OUT01 ≙ 0...20 mA OUT02 ≙ 4...20 mA OUT03 ≙ 0...10 V OUT04 ≙ 2...10 V OUT05 ≙ 0...5 V OUT06 ≙ 1...5 V OUT07 ≙ 20...0 mA OUT08 ≙ 20...4 mA OUT09 ≙ 10...0 V OUT10 ≙ 10...2V OUT11 ≙ 5...0 V OUT12 ≙ 5...1 V OUT13 ≙ -5...+5 V OUT14 ≙ -10...+10 V OUT17 ≙ +10...-10 V OUT18 ≙ +5...-5 V	Switching threshold between 1 ... 110% 50 ≙ 50% of set upper measuring range value (here: 25 A)	between 0.1 ... 20 s 3.0 ≙ 3 s	A ≙ Operating current controlled R ≙ Closed-circuit current controlled	O ≙ Overrange U ≙ Underrange
2814663 ≙ MCR-S-10-50-UI-SW-DCI	0.0 ≙ 0.0 A	50.0 ≙ 50.0 A					

Function diagrams: Switching behavior of relay and transistor output:

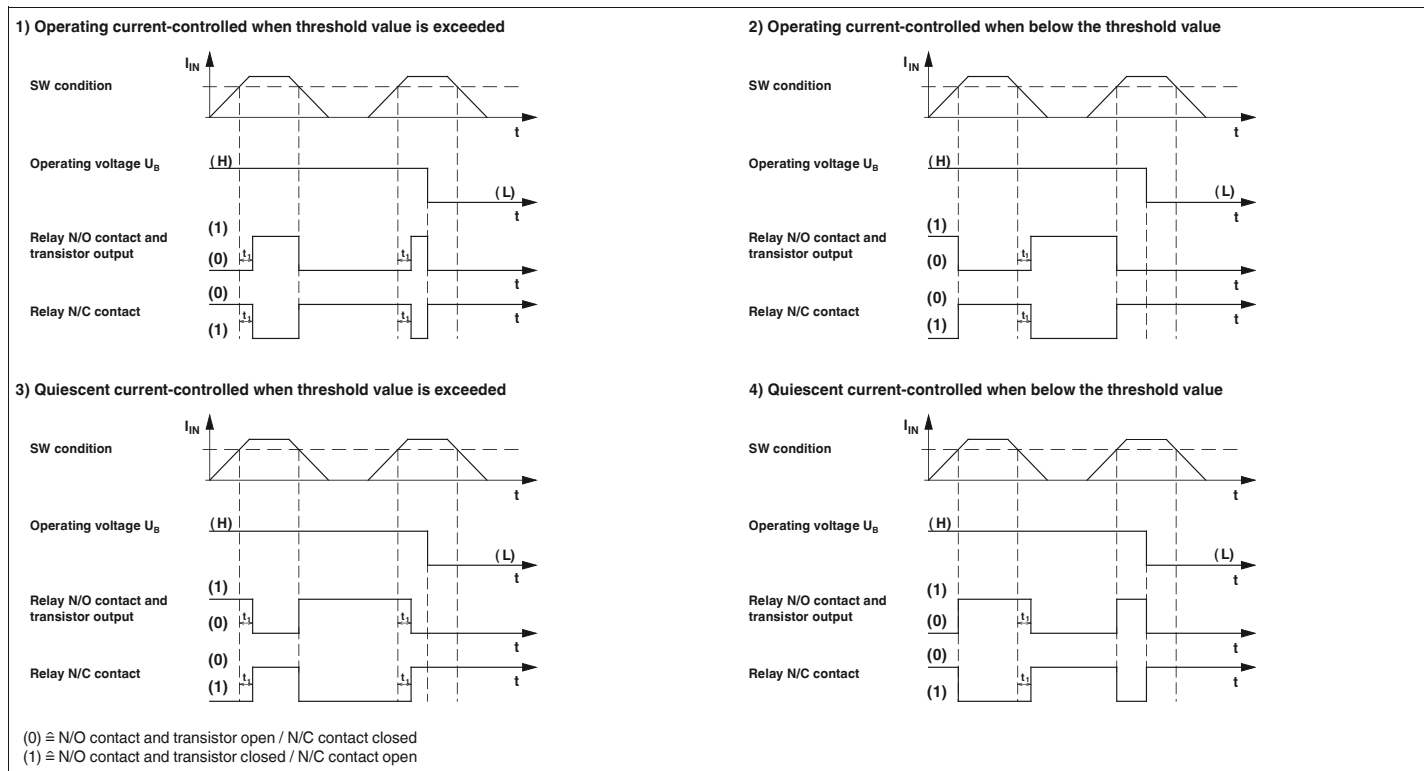

Monitoring

Current and voltage measuring technology

AC current transducers, sinusoidal

The **MCR-SL-CAC-...** current transducers measure sinusoidal alternating currents within the range 0 ... 1/5/12 A.

- Wide-range version from 19.2 ... 253 V AC/DC
- 3-way isolation
- Input/output can be configured using the DIP switch



For sinusoidal alternating currents
0 ... 1 A/0 ... 5 A



For sinusoidal alternating currents
0 ... 5 A/0 ... 12 A

Notes:
1) EMC: Class A product, see page 571

Ex:
Housing width 22.5 mm

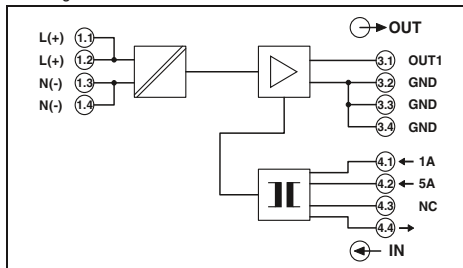

Housing width 22.5 mm

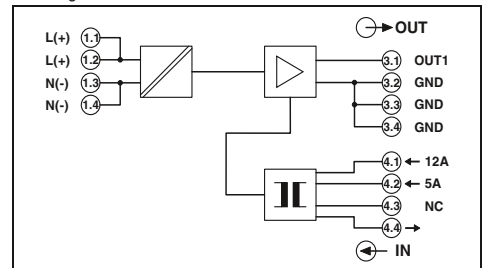

Technical data

Input data	0 A AC ... 1 A AC (configurable) / 0 A AC ... 5 A AC (configurable)	0 A AC ... 5 A AC (configurable) / 0 A AC ... 12 A AC (configurable)
Nominal frequency	50 Hz	50 Hz
Frequency range	45 Hz ... 65 Hz	45 Hz ... 65 Hz
Curve type	Sine	Sine
Overload capacity	2 x I _N (continuous)	1 x I _N (continuous)
Surge strength	20 x I _N (1 s)	8 x I _N (1 s)
Connection method	Screw terminal block	Screw terminal block
Output data	0 ... 20 mA / 4 ... 20 mA	0 ... 20 mA / 4 ... 20 mA
Output signal (configurable)	25 mA	25 mA
Maximum output signal	< 500 Ω (at 20 mA)	< 500 Ω (at 20 mA)
Load R _B	< 10 mV _{pp} (for 500 Ω at 20 mA)	< 10 mV _{pp} (for 500 Ω at 20 mA)
Ripple	MACX MCR-SL-CAC-5-I ¹⁾	MACX MCR-SL-CAC-12-I-UP ¹⁾
General data	19.2 V DC ... 30 V DC	19.2 V AC/DC ... 253 V AC/DC
Supply voltage U _B	< 32 mA	< 30 mA
Current consumption	(at U _B =24 V DC, I _{OUT} =20 mA)	(at U _B =24 V DC, I _{OUT} =20 mA)
Maximum transmission error	≤ 0.5% (of nominal range value under nominal conditions)	≤ 0.5% (of nominal range value under nominal conditions)

Technical data

Temperature coefficient	< 0.02%/K	< 0.02%/K
Step response (10 - 90%)	max. 300 ms Typ. 200 ms	max. 300 ms Typ. 200 ms
Safe isolation	acc. to EN 61010	acc. to EN 61010
Rated insulation voltage	-	-
Surge voltage category Input/output	-	-
Pollution degree	2	2
Test voltage input/output	4 kV (50 Hz, 1 min.)	4 kV (50 Hz, 1 min.)
Test voltage output/power supply	1.5 kV (50 Hz, 1 min.)	2 kV (50 Hz, 1 min.)
Degree of protection	IP20	IP20
Ambient temperature range	-20°C ... 65°C (-4°F ... 149°F)	-20°C ... 65°C (-4°F ... 149°F)
Dimensions W / H / D	22.5 / 104 / 114.5 mm	22.5 / 104 / 114.5 mm
Screw connection solid / stranded / AWG	0.2 ... 2.5 mm ² / 0.2 ... 2.5 mm ² / 24 - 14	0.2 ... 2.5 mm ² / 0.2 ... 2.5 mm ² / 24 - 14
Conformance / approvals	CE-compliant ATEX UL, USA / Canada	CE-compliant Ex II 3 G Ex n A II T4 X UL 508 Recognized

Ordering data

Type	Order No.	Pcs. / Pkt.
MACX MCR-SL-CAC-5-I ¹⁾	2810612	1
MACX MCR-SL-CAC-5-I-UP ¹⁾	2810625	1

Accessories

ME 22,5 TBUS 1,5/ 5-ST-3,81 GN	2707437	50
--------------------------------	---------	----

Ordering data

Type	Order No.	Pcs. / Pkt.
MACX MCR-SL-CAC-12-I-UP ¹⁾	2810638	1

Accessories

--	--	--

AC current transducers, sinusoidal and distorted

The **MCR-SL-S-...00-...** current transducers measure sinusoidal and non-sinusoidal alternating currents within the range 0 ... 200 A.

- True/r.m.s. value measurement from 30...6000 Hz
- Measuring range selection with slide switch
- Loop-powered
- Can be retrofitted with the open-up Rogowski coil

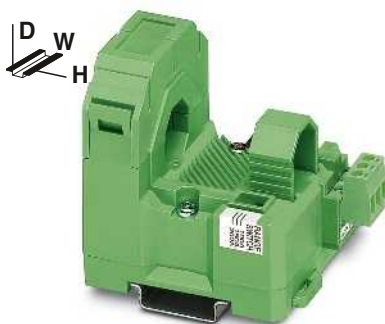

For sinusoidal and non-sinusoidal alternating currents, 0 ... 200 A, voltage output

Ex: Housing width 55 mm

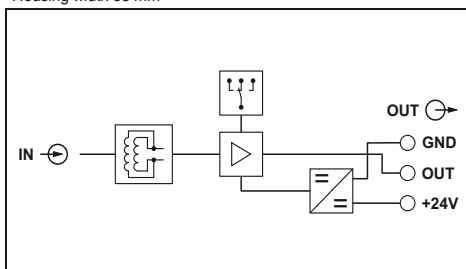

Technical data

Input data	...
Input current (configurable)	0 A ... 100 A (0...50/75/100 A)
Operate threshold	1% (of final value)
Frequency range	30 Hz ... 6000 Hz
Curve type	Sinusoidal and non-sinusoidal
Overload capacity	Depending on laid conductor
Surge strength	Depending on through connected conductor
Connection method	Clamp-on cable design, diameter 18.5 mm
Output data	0 ... 5 V / 0 ... 10 V
Output signal	((0 V ... 10 V) 14 V, (0 V ... 5 V) 7 V)
Maximum output signal	≥ 10 kΩ
Load R _B	
General data	
Supply voltage U _B	20 V DC ... 30 V DC
Current consumption	< 30 mA
Maximum transmission error	< 1% (of final value)
Cable position error	< 0.63%
Temperature coefficient	< 0.035%/K
Step response (10 - 90%)	< 340 ms
Safe isolation	As per IEC 61010-1 and IEC 61326
Rated insulation voltage	300 V AC (to ground)
Surge voltage category / pollution degree	III / 2
Test voltage input/output	5 kV (50 Hz, 1 min.)
Degree of protection	IP20
Ambient temperature range	-20°C ... 60°C
Dimensions W / H / D	55 / 85 / 70.5 mm
Screw connection solid / stranded / AWG	0.2 ... 2.5 mm ² / 0.2 ... 2.5 mm ² / 24 - 14
Conformance / approvals	
Conformance	CE-compliant
UL, USA / Canada	cULus

Ordering data

Description	Type	Order No.	Pcs. / Pkt.
MCR current measuring transducers for sinusoidal and non-sinusoidal alternating currents			
Input current range: 0...50/75/100 A	MCR-SL-S-100-U	2813457	1
Input current range: 0..0.100/150/200 A	MCR-SL-S-200-U	2813460	1

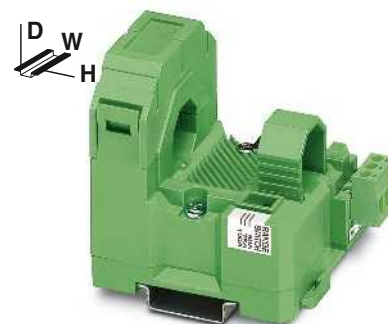

For sinusoidal and non-sinusoidal alternating currents, 0 ... 200 A, current output (loop-powered)

Ex: Housing width 55 mm

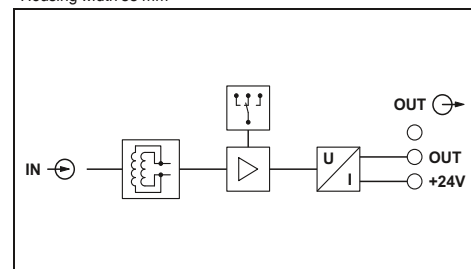

Technical data

...	...
Input current (configurable)	0 A ... 100 A (0...50/75/100 A)
Operate threshold	1% (of final value)
Frequency range	30 Hz ... 6000 Hz
Curve type	Sinusoidal and non-sinusoidal
Overload capacity	Depending on laid conductor
Surge strength	Depending on through connected conductor
Connection method	Clamp-on cable design, diameter 18.5 mm
Output data	4 ... 20 mA
Output signal	< 25 mA
Maximum output signal	((U _B - 12 V) x 350 / 12 A)
Load R _B	
General data	
Supply voltage U _B	20 V DC ... 30 V DC
Current consumption	< 30 mA
Maximum transmission error	< 1% (of final value)
Cable position error	< 0.63%
Temperature coefficient	< 0.025%/K
Step response (10 - 90%)	< 340 ms
Safe isolation	As per IEC 61010-1 and IEC 61326
Rated insulation voltage	300 V AC (to ground)
Surge voltage category / pollution degree	III / 2
Test voltage input/output	5 kV (50 Hz, 1 min.)
Degree of protection	IP20
Ambient temperature range	-20°C ... 60°C
Dimensions W / H / D	55 / 85 / 70.5 mm
Screw connection solid / stranded / AWG	0.2 ... 2.5 mm ² / 0.2 ... 2.5 mm ² / 24 - 14
Conformance / approvals	
Conformance	CE-compliant
UL, USA / Canada	cULus

Ordering data

Description	Type	Order No.	Pcs. / Pkt.
MCR current measuring transducers for sinusoidal and non-sinusoidal alternating currents			
Input current range: 0...50/75/100 A	MCR-SL-S-100-I-LP	2813486	1
Input current range: 0..0.100/150/200 A	MCR-SL-S-200-I-LP	2813499	1

Current and voltage measuring technology

Passive AC current transducers, sinusoidal

The **MCR-SLP-1-5-UI-0** passive current transducer measures sinusoidal alternating currents within the range 0 ... 1 A/0 ... 5 A.

- Loop-powered
- Measuring ranges 1 A and 5 A AC, reconnectable

Notes:
1) EMC: Class A product, see page 571



**For sinusoidal alternating currents
0 ... 1 A/0 ... 5 A**

Housing width 22.5 mm

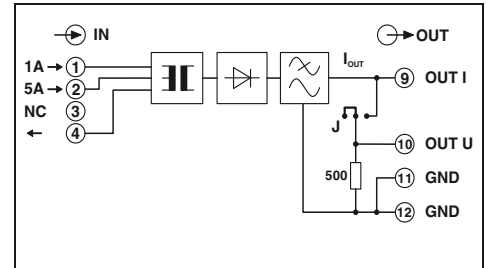

Technical data

Input data	1 A input	5 A input
Input current	0 A AC ... 5 A AC	0 A AC ... 0.005 A AC
Frequency range	45 Hz ... 60 Hz	45 Hz ... 60 Hz
Curve type	Sine	Sine
Overload capacity	2 x I _N (5 min. at 60°C ambient temperature)	-
Surge strength	50 A (1 s)	100 A (1 s)
Permissible output range	1.2 x I _N	1.2 x I _N
Connection method	Screw connection	Screw connection
Output data	U output	I output
Output signal	0 ... 10 V	0 ... 20 mA
Maximum output signal	20 V	30 mA
Load R _B	> 100 kΩ	< 750 Ω < 250 Ω (when current and voltage outputs are used simultaneously)
Ripple	< 50 mV _{PP}	< 50 mV _{PP}
General data	Maximum transmission error	< 0.5% (of final value)
	Temperature coefficient	< 0.015%/K
	Step response (10 - 90%)	< 200 ms
	Safe isolation	as per EN 50178, EN 61010
	Rated insulation voltage	300 V AC (to ground)
	Surge voltage category / pollution degree	III / 2
	Test voltage input/output	4 kV (50 Hz, 1 min.)
	Degree of protection	IP20
	Ambient temperature range	-25°C ... 60°C
	Dimensions W / H / D	22.5 / 99 / 114.5 mm
	Screw connection solid / stranded / AWG	0.2 ... 2.5 mm ² / 0.2 ... 2.5 mm ² / 24 - 14
Conformance / approvals	Conformance	CE-compliant

Ordering data

Description	Type	Order No.	Pcs. / Pkt.
MCR passive current measuring transducers for sinusoidal alternating currents	MCR-SLP-1-5-UI-0¹⁾	2814359	1

AC current protectors, sinusoidal

Notes:
1) EMC: Class A product, see page 571

The **MCR-SL-S-16-SP-24** current protector converts sinusoidal 50 Hz/60 Hz alternating currents into binary switching signals.

- Switching point can be freely selected in the measuring range of 0...16 A AC
- Changeover relay output
- Adjustable switch hysteresis
- 3-way isolation
- Settable operating current/quiescent current behavior



For sinusoidal alternating currents, 0 ... 16 A AC

Housing width 22.5 mm

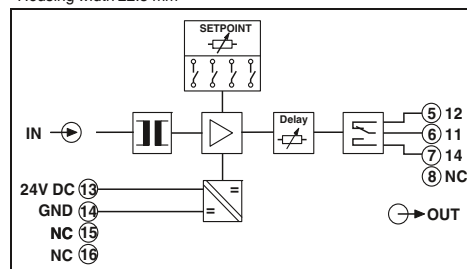

Technical data

Input data	Input current	Frequency range	Curve type	Overload capacity	Connection method
Switching output	Contact type	Contact material	Maximum switching current	Switching hysteresis	Response delay
General data	Supply voltage U_B	Current consumption	Setting accuracy	Temperature coefficient	Step response (10 - 90%)
	Safe isolation	Rated insulation voltage	Surge voltage category / pollution degree	Test voltage input/output	Test voltage input/power supply
	Degree of protection	Ambient temperature range	Dimensions W / H / D	Screw connection solid / stranded / AWG	Conformance / approvals
	Conformance				

0 A AC ... 16 A AC	45 Hz ... 65 Hz	Sine	$2 \times I_N$ (continuous)	Through connection, diameter 4.2 mm
Relay output	1 PDT	AgSnO, hard gold-plated	50 mA (for gold layer, 30 V AC/ 36 V DC)	2 A (in case of a destroyed gold layer, 250 V AC)
Adjustable using a DIP switch (0.5%, 5%, 10%, 15%)	Typ. 0.1 s ... 10 s (Adjustable using a potentiometer)	Adjustable using a DIP switch	Yellow LED (relay active)	
20 V DC ... 30 V DC	< 30 mA	< 0.5%	< 0.02%/K	40 ms
as per EN 50178, EN 61010-1	300 V AC (to ground)	III / 2	4 kV (50 Hz, 1 min.)	4 kV (50 Hz, 1 min.)
IP20	-20°C ... 65°C	22.5 / 99 / 114.5 mm	0.2 ... 2.5 mm ² / 0.2 ... 2.5 mm ² / 24 - 14	
CE-compliant				

Ordering data

Description	MCR current protector for sinusoidal alternating currents
-------------	--

Type	Order No.	Pcs. / Pkt.
MCR-SL-S- 16-SP- 24 ¹⁾	2864464	1

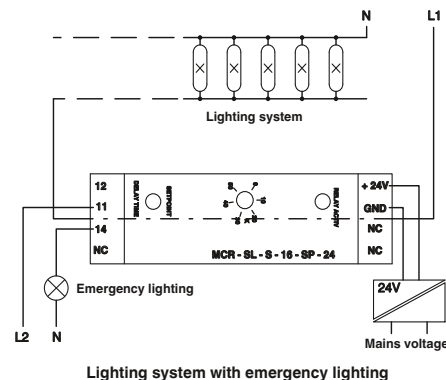

Monitoring

Current and voltage measuring technology

Voltage transducers

The **MCR-VDC-UI-B-DC** voltage transducer measures DC voltages within the range 0 ... ±660 V DC.

The **MCR-VAC-UI-O-DC** voltage transducer measures sinusoidal AC voltages from 0 ... 444 V AC.

- Bidirectional output signals
- Adjustable voltage ranges
- ZERO/SPAN adjustment ±20%
- 3-way isolation

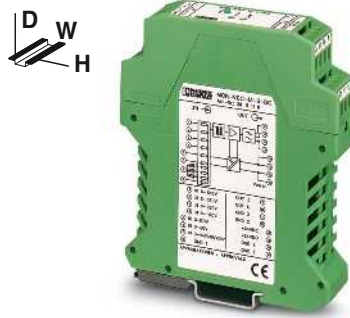

For DC voltages
0 ... ±660 V DC



For sinusoidal AC voltages
0...444 V AC

Notes:
1) EMC: Class A product, see page 571

Housing width 22.5 mm

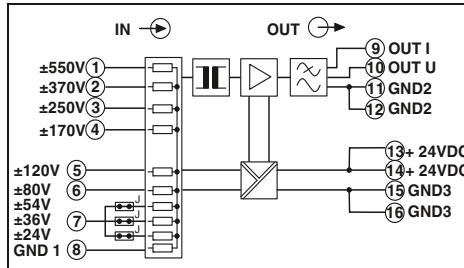

Technical data

-550 V DC ... 550 V DC	550 kΩ
-370 V DC ... 370 V DC	370 kΩ
-250 V DC ... 250 V DC	250 kΩ
-170 V DC ... 170 V DC	170 kΩ
-120 V DC ... 120 V DC	120 kΩ
-80 V DC ... 80 V DC	80 kΩ
-54 V DC ... 54 V DC	54 kΩ
-36 V DC ... 36 V DC	36 kΩ
-24 V DC ... 24 V DC	24 kΩ
±20% / ±20%	-

Input data
Input voltage range / resistor

ZERO / SPAN adjustment
Frequency range

Output data
Output signal
Maximum output signal
Load R_B
Ripple

General data
Supply voltage U_B
Current consumption
Maximum transmission error
Temperature coefficient
Limit frequency (3 dB)
Step response (10 - 90%)
Safe isolation
Rated insulation voltage
Surge voltage category / pollution degree
Test voltage input/output
Degree of protection
Ambient temperature range
Dimensions W / H / D
Screw connection solid / stranded / AWG
Conformance / approvals
Conformance

U output	I output
-10 ... 10 V	-20 ... 20 mA
±15 V	±30 mA
> 10 kΩ	< 500 Ω
< 50 mV _{pp}	< 50 mV _{pp}
18.5 V DC ... 30.2 V DC	
< 50 mA	
< 1% (of final value)	
< 0.015%/K	
40 Hz	
12 ms	
acc. to EN 50178	
-	
III / 2	
1.5 kV (50 Hz, 1 min.)	
IP20	
-25°C ... 50°C	
22.5 / 99 / 114.5 mm	
0.2 ... 2.5 mm ² / 0.2 ... 2.5 mm ² / 24 - 14	
CE-compliant	

Housing width 22.5 mm

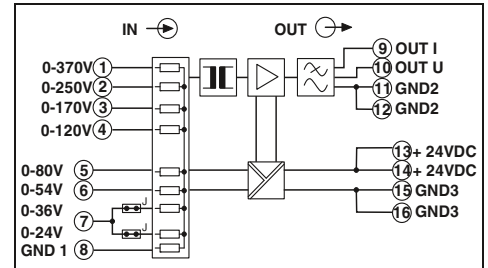

Technical data

0 V ... 370 V AC	370 kΩ
0 V ... 250 V AC	250 kΩ
0 V ... 170 V AC	170 kΩ
0 V ... 120 V AC	120 kΩ
0 V ... 80 V AC	80 kΩ
0 V ... 54 V AC	54 kΩ
0 V ... 36 V AC	36 kΩ
0 V ... 24 V AC	24 kΩ
±20% / ±20%	-

Frequency range

Output data
U output
I output

45 Hz ... 400 Hz	
U output	I output
0 ... 10 V	0 ... 20 mA / 4 ... 20 mA
15 V	30 mA
> 10 kΩ	< 500 Ω
< 50 mV _{pp}	< 50 mV _{pp}
18.5 V DC ... 30.2 V DC	
< 45 mA	
< 1.5% (of final value)	
-	
250 ms	
acc. to EN 50178	
300 V DC	
III / 2	
3.3 kV (50 Hz, 1 min.)	
IP20	
-25°C ... 60°C	
22.5 / 99 / 114.5 mm	
0.2 ... 2.5 mm ² / 0.2 ... 2.5 mm ² / 24 - 14	
CE-compliant	

Ordering data

Description
MCR voltage measuring transducer, for DC voltages from 0...±20 V DC to 0...±660 V DC

MCR voltage transducer, for sinusoidal AC voltages from 0...20 V AC to 0...440 V AC

Type	Order No.	Pcs. / Pkt.
MCR-VDC-UI-B-DC ¹⁾	2811116	1

Ordering data

Type	Order No.	Pcs. / Pkt.
MCR-VAC-UI-O-DC ¹⁾	2811103	1

Accessories

Configuration software package

The **MCR/PI-CONF-WIN configuration software package** is used to configure and visualize all parameters for the programmable MCR measuring transducers.

- Straightforward menu interface
- Rapid programming

Notes:

The software runs under the following operating systems: Windows NT™, 2000™, and XP™.



For MCR-S... current transducer

Description		Ordering data		
MCR configuration software , for programming MCR-T-..., MCR-...-LP-..., MCR-...-HT-..., MCR-S-..., MCR-F-..., and MCR-PSP-... modules, CD-ROM		Type	Order No.	Pcs. / Pkt.
		MCR/PI-CONF-WIN	2814799	1
Labels, for labeling MCR-T and MCR-S modules, four sheets DIN A4 marking labels (112 pieces)		Accessories		
		MCR-ET 38X35 WH	2814317	1

USB adapter cable

Software adapter cable

The following adapter cables are available for programming the MCR-S... current transducers:

- USB adapter cable
- Software adapter cable



For MCR-S... current transducer

Description		Ordering data		
USB adapter cable , D-9-SUB to USB, with adapter D-9-SUB to D-25-SUB		Type	Order No.	Pcs. / Pkt.
		CM-KBL-RS232/USB	2881078	1
Software adapter cable (stereo jack plug/25-pos. D-SUB), 1.2 m long, for programming MCR-T-..., MCR-S-..., and MCR-F-... modules				
		MCR-TTL-RS232-E	2814388	1
Adapter cable, stranded, 9-pos. D-SUB socket on 25-pos. D-SUB pin		Accessories		
		PSM-KAD 9 SUB 25/BS	2761295	1

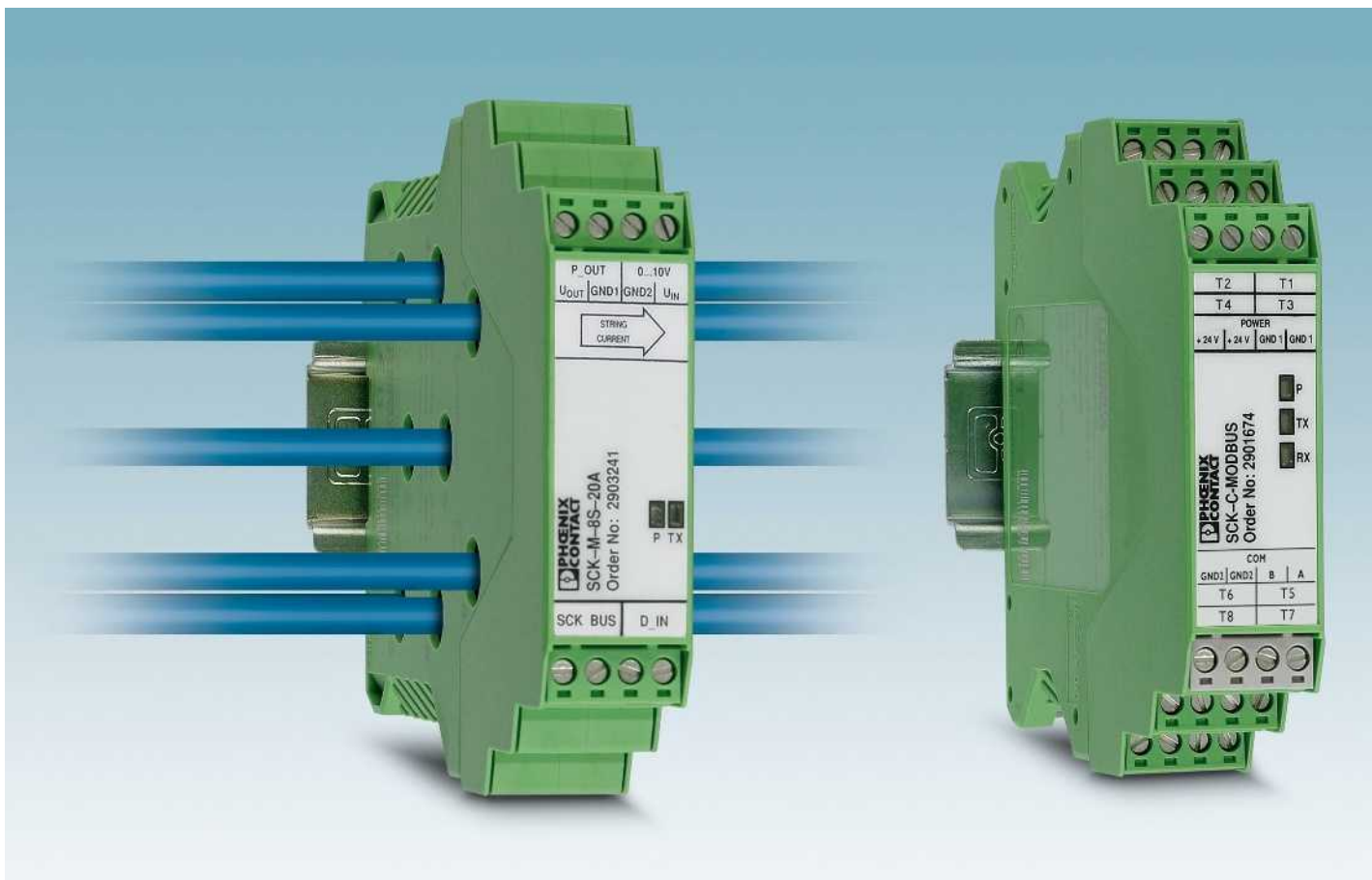

Utilize solar electricity efficiently

Detect errors – increase efficiency: photovoltaic systems should achieve maximum energy yield within the shortest possible time.

SOLARCHECK provides reliable information regarding the performance of your photovoltaic system. It can be used to detect faults, which may be caused by damaged panels, defective contacts or damage in the cabling. This allows you to implement countermeasures quickly, thereby increasing the efficiency of your system.

Current topic: reliable monitoring

Whether a small roof-top system on a family home or a megawatt outdoor system: for reliable operation, the photovoltaic market requires monitoring systems where status information is continuously available and visualization is easy. Phoenix Contact offers a comprehensive portfolio of hardware and software products specifically designed for this purpose.

Energy of the future

From installation to monitoring - in the "Components and systems for photovoltaics" brochure you will find further innovative solutions for your photovoltaic system, such as:

- Connection technology
- Surge protection
- Hardware and software solutions
- Generator connection boxes
- Tools and marking

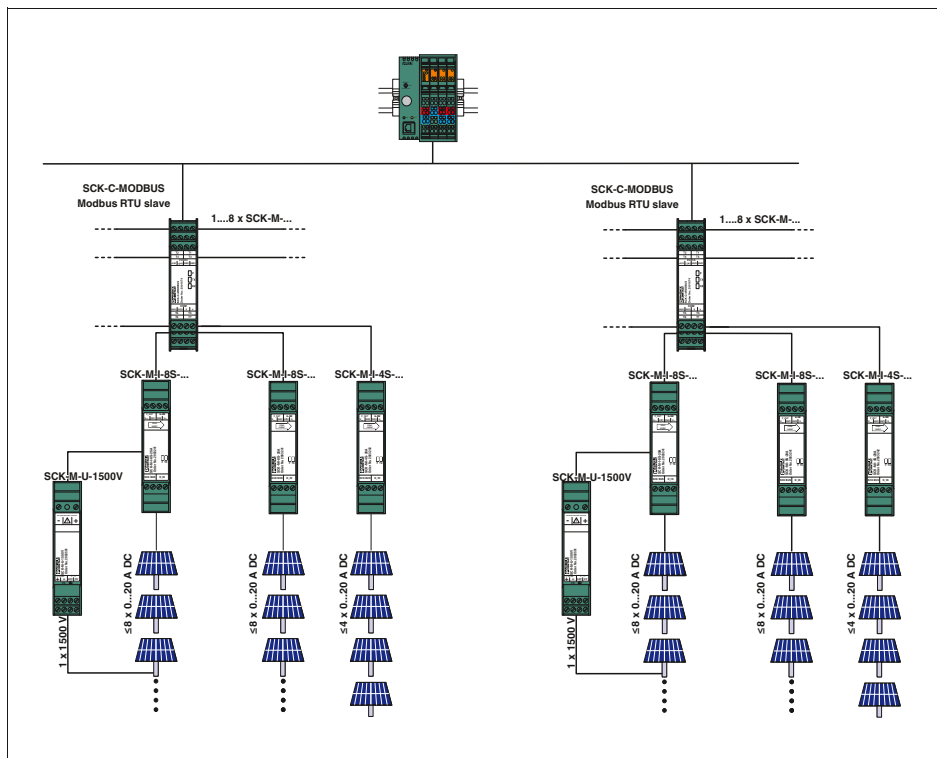

Easy integration in monitoring systems

The modular Solarcheck monitoring system consists of various measuring modules for current and voltage measurement and an associated communication module.

The communication module collects the measured values from the current measuring modules and forwards them to a higher-level controller. You can acquire up to eight or four string currents with one current measuring module each. A maximum of eight current measuring modules of any type can be connected to one communication module. The 2-conductor communication cable is also used to supply the measuring modules with power. This means that no additional power supply unit is required in the field.

The voltage measuring module is usually connected to and also supplied via the analog input provided on the 8-channel current measuring modules.



Contact-free current measurement

Contact-free measurement using Hall sensors offers many advantages:

- Safe isolation is already ensured by the cable insulation.
- No contact resistance due to additional contact points.
- The current is forwarded safely as the line circuit is not directly accessed.

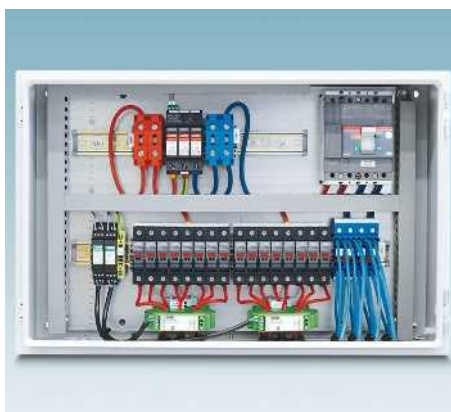

Space-saving installation without an additional power supply unit

With a width of just 22.5 mm, the narrow measuring module bundles the cables in a confined space.

- The 2-conductor communication cable is also used to supply the measuring modules.
- This means that one communication module supplies up to eight measuring modules – without an additional power supply unit.

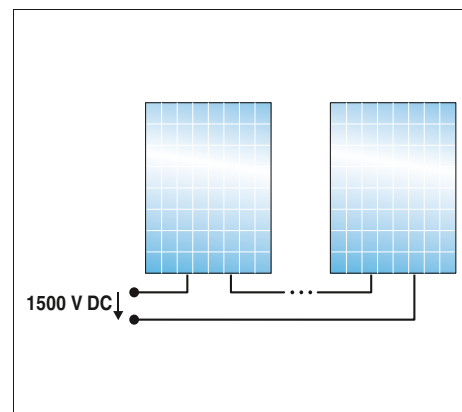

Flexible expansion

Optional extension of voltage measurement up to 1500 V DC.

- Also suitable for grounded systems.
- Suitable for PV systems with extra high system voltages.
- Flexible use, even outside the Solarcheck system.

Monitoring

Solar and PV system monitoring

PV string monitoring Solarcheck

The modular Solarcheck monitoring system consists of various devices for current and voltage measurement and an associated communication module.

Communication module:

- For connecting and collecting measured values from up to eight measuring modules
- Provision of data for transfer to higher-level controllers

Current measuring modules:

- 8-channel current measurement up to 20 A DC
- Detection of reverse currents up to -1 A
- 4-channel extension modules for 20 A DC
- Internal temperature monitoring
- Digital input for monitoring, e.g., the remote indication contacts of surge protection modules
- Supply via the communication module

Voltage measuring module

- Voltage measurement up to 1500 V DC in any grounded PV system
- Connection and supply is usually via the analog input provided (0 ... 10 V) on the 8-channel Solarcheck current measuring module
- Output of the voltage measured value as a 2 ... 10 V analog signal
- As an option, can also be removed from the Solarcheck group and used separately

Notes:
1) EMC: Class A product, see page 571



N

**Communication module
RS-485 (Modbus RTU)**

Housing width 22.5 mm

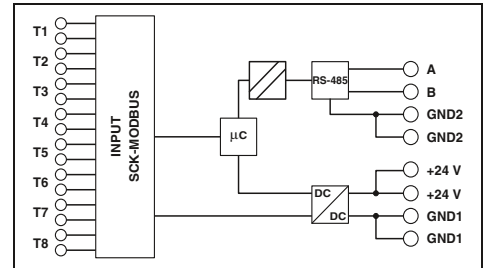

Supply	
Supply voltage	24 V DC -10% ... +25%
Own current consumption	12 mA
Measuring input	
Current measuring range	-
Maximum transmission error	-
Temperature coefficient	-
Reverse current detection	-
Number of measuring channels	-
Voltage measuring range	-
Connection method	-
Digital input	
Controlled by external floating contact	-
Analog input	
Input voltage range	-
Analog output	
Output voltage range	-
SCK-C-MODBUS data interface	
Cable length (for 0.15 mm ²)	-
Communication protocol	-
Serial port	RS-485
Serial transmission speed	9.6/14.4/19.2/38.4 kbps
Cable length	≤ 1200 m
Communication protocol	Modbus RTU
General data	
Degree of protection	IP20
Ambient temperature range	-20°C ... 70°C
Dimensions W / H / D	22.5 / 102 / 106 mm
Screw connection solid / stranded / AWG	0.14 ... 1.5 mm ² / 0.14 ... 1.5 mm ² / 26 - 16
Conformance / approvals	
Conformance	CE-compliant

Technical data

Supply	
Supply voltage	24 V DC -10% ... +25%
Own current consumption	12 mA
Measuring input	
Current measuring range	-
Maximum transmission error	-
Temperature coefficient	-
Reverse current detection	-
Number of measuring channels	-
Voltage measuring range	-
Connection method	-
Digital input	
Controlled by external floating contact	-
Analog input	
Input voltage range	-
Analog output	
Output voltage range	-
SCK-C-MODBUS data interface	
Cable length (for 0.15 mm ²)	-
Communication protocol	-
Serial port	RS-485
Serial transmission speed	9.6/14.4/19.2/38.4 kbps
Cable length	≤ 1200 m
Communication protocol	Modbus RTU
General data	
Degree of protection	IP20
Ambient temperature range	-20°C ... 70°C
Dimensions W / H / D	22.5 / 102 / 106 mm
Screw connection solid / stranded / AWG	0.14 ... 1.5 mm ² / 0.14 ... 1.5 mm ² / 26 - 16
Conformance / approvals	
Conformance	CE-compliant

Ordering data

Description	
Communication module	
Current measuring module, 8-channel	
Current measuring module, 4-channel for extension	
Voltage measuring module	

Type	Order No.	Pcs. / Pkt.
SCK-C-MODBUS ¹⁾	2901674	1



Current measuring module, 20 A DC, 8-channel



Extension module, 4-channel Current measurement 20 A DC



Voltage measuring module, 0...1500 V DC



Housing width 22.5 mm

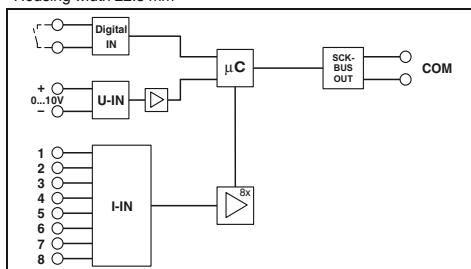

Technical data

-
45 mA
0 A ... 20 A
±1% (From the measuring range final value)
0.02%/K (From T > 25°C)
-1 A ... 0 A
8
-
Through connection, 9.5 mm diameter
Floating switch contacts
0 V ... 10 V
-
max. 300 m
Proprietary
-
-
-
IP20
-20°C ... 70°C
22.5 / 102 / 128.5 mm
0.14 ... 1.5 mm ² / 0.14 ... 1.5 mm ² / 26 - 16
CE-compliant

Housing width 22.5 mm

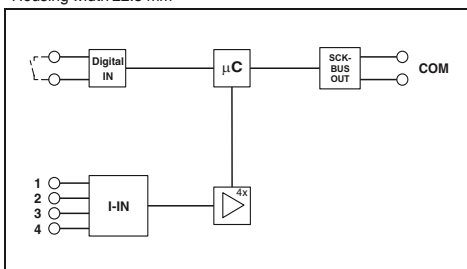

Technical data

-
45 mA
0 A ... 20 A
±1% (From the measuring range final value)
0.02%/K (From T > 25°C)
-1 A ... 0 A
4
-
Through connection, 9.5 mm diameter
-
-
-
max. 300 m
Proprietary
-
-
-
IP20
-20°C ... 70°C
22.5 / 102 / 128.5 mm
0.14 ... 1.5 mm ² / 0.14 ... 1.5 mm ² / 26 - 16
CE-compliant

Ordering data

Type	Order No.	Pcs. / Pkt.
SCK-M-I-8S-20A	2903241	1
SCK-M-I-4S-20A	2903242	1

Housing width 22.5 mm

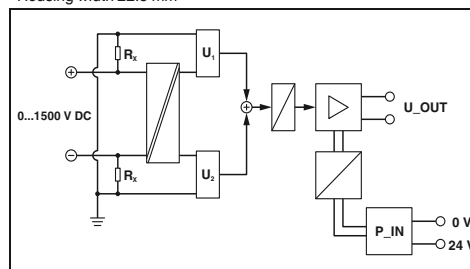

Technical data

24 V DC -10% ... +25% (or via SCK-M-I-8S-...)
35 mA
-
1% (After additional adjustment)
< 0.03%/K
-
1
0 V DC ... 1500 V DC
Screw connection
-
-
2 V ... 10 V
max. 0.5 m
-
-
-
IP20
-20°C ... 70°C
22.5 / 102 / 128.5 mm
0.14 ... 1.5 mm ² / 0.14 ... 1.5 mm ² / 26 - 16
CE-compliant

Ordering data

Type	Order No.	Pcs. / Pkt.
SCK-M-U-1500V	2903591	1

Monitoring

Residual current monitoring

Detect errors before they actually occur



RCM devices provide residual current monitoring in grounded power supply systems. They detect residual currents at an early stage, such as those that occur as a result of insulation errors. They can therefore be used to prevent forced system shutdown. Plans can be made to remove errors outside of operating hours. RCM devices also act as a form of fire prevention.

Increasing use is being made of equipment such as frequency inverters. In the event of an error, residual currents with a frequency of up to 50 kHz can be generated. Type B+ RCM devices from Phoenix Contact are already able to detect residual currents with frequencies up to 100 kHz. This far exceeds present-day requirements of 20 kHz for type B+ devices.

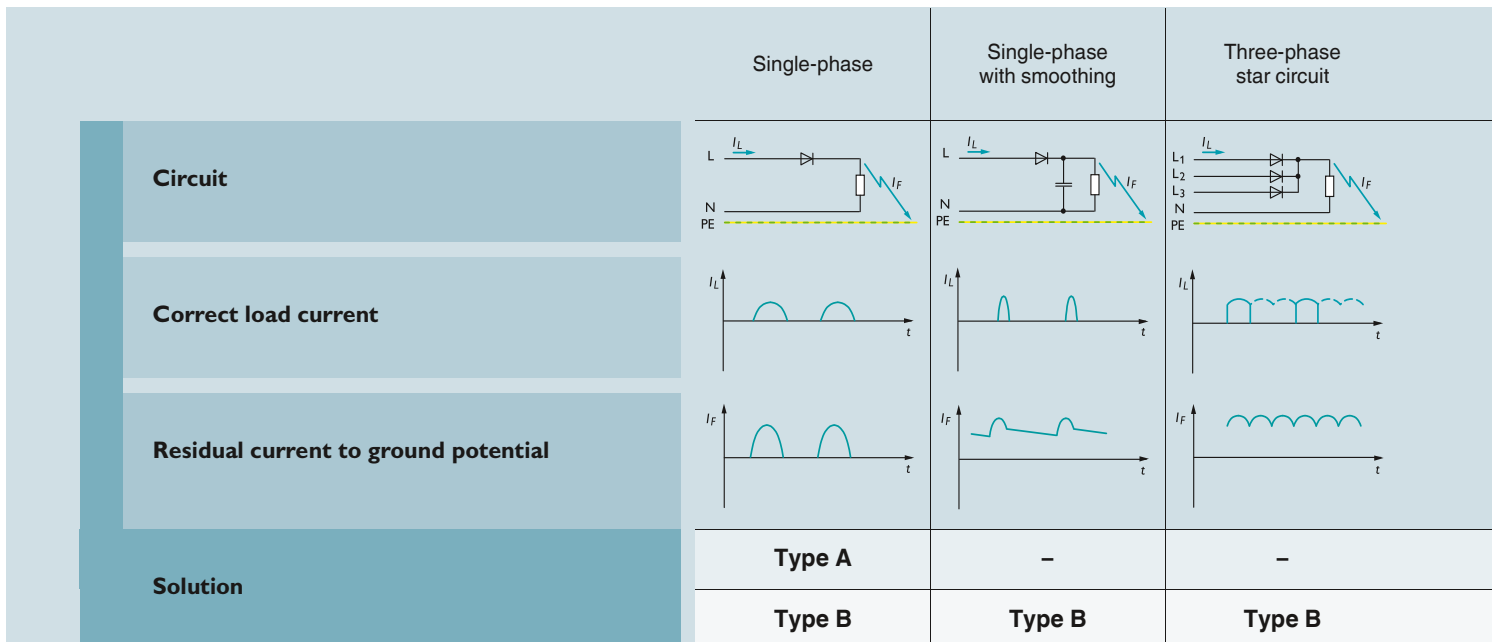

Residual currents can increase continually due to gradual processes. This can be attributed to humidity or conductive dirt on live parts, for example. Residual current circuit breakers trip at different rated residual currents $I_{\Delta n}$, depending on their type. Additionally installed residual current monitoring devices prevent sudden system downtimes thanks to early warnings. The continuous supply of information about gradually increasing residual currents allows timely intervention. Unplanned system failures can be avoided.

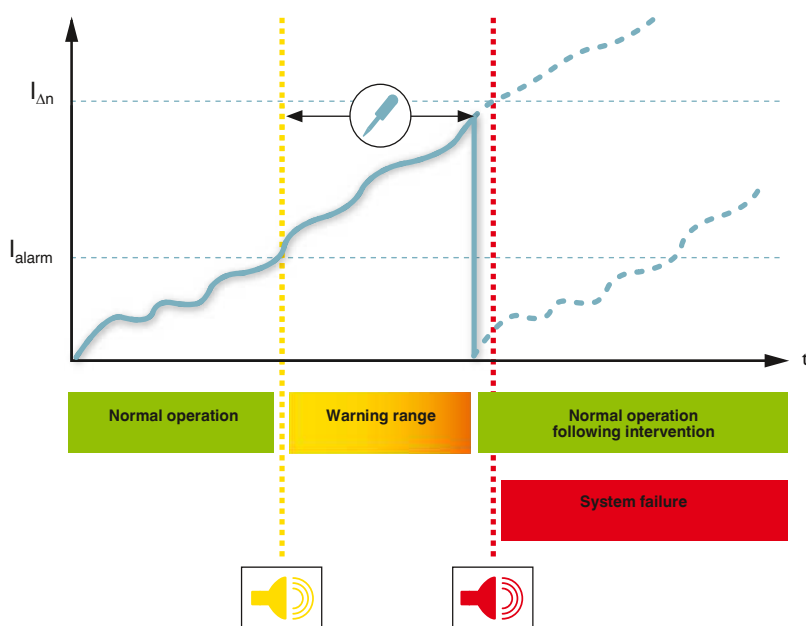

Full bridge circuit	Semi-controlled full bridge circuit	Full bridge circuit between phase conductors	Three-phase full bridge circuit	Phase-controlled modulator	Burst control
Type A	Type A	–	–	Type A	Type A
Type B	Type B	Type B	Type B	Type B	Type B

Monitoring

Residual current monitoring

Residual current monitoring - RCM

- Adjustable residual response current of 30 mA to 3 A
- Adjustable pre-alarm threshold and delay time
- Actual differential current can be read via LED display
- Remote signaling for main and pre-alarm



kHz



RCM type B+ for smooth and pulsating DC and AC residual currents up to 100 kHz



Converter for RCM type B+

Notes:
Cables for type B+ converter connection (RJ45, 4-pair, 1:1 line) can be found in the accessories section by entering the order number (RCM/converter) at: www.phoenixcontact.net/products

Total width 71.6 mm

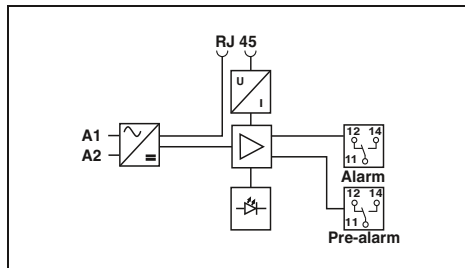

Total width 65.5 mm

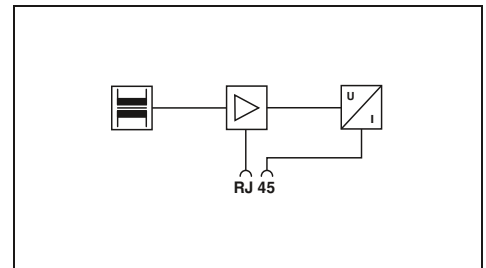

Technical data

Electrical data	
Nominal voltage range	85 V AC ... 264 V AC
Nominal frequency f_N	50 Hz (60 Hz)
Rated current I_n	-
Max. required back-up fuse	16 A (B)
RCM data	
Rated response differential current I_{dyn}	3 A
Differential current acquisition characteristic	Type B+ (DC up to 100 kHz)
Response differential current $I_{\Delta n}$	30, 100, 300, 1000, 3000 mA (adjustable)
Discrimination threshold main alarm	80% ... 100% (of the set response differential current $I_{\Delta n}$)
Discrimination threshold pre-alarm	10% ... 90% (of the main alarm threshold, adjustable)
Response time for $2 \times I_{\Delta n}$	0.1 s ... 1 s (adjustable)
Thermal permanent differential current $I_{\Delta th}$	-
Thermal rated short-time differential current $I_{\Delta th}$	-
Rated surge voltage resistance U_{imp}	4 kV
General data	
Connection data solid / stranded / AWG	0.2 ... 4 mm ² / 0.2 ... 2.5 mm ² / 24 - 12
Maximum permissible outside diameter of cables	-
Housing material	polycarbonate
Ambient temperature (operation)	-25°C ... 65°C
Degree of protection	IP20
Test standards	DIN EN 62020 / DIN EN 60664 / DIN VDE 0664-110
Test standards	-
Pollution degree	2
Surge voltage category	III
Mounting	
Mounting type	DIN rail: 35 mm
Remote indication contact	PDT contact
Connection data solid / stranded / AWG	0.2 ... 4 mm ² / 0.2 ... 2.5 mm ² / -
Max. operating voltage	230 V AC
Max. operating current	5 A (cos phi > 0.9)

Technical data

	...SCT-35	...SCT-70	...SCT-105
Nominal voltage range	-	-	-
Nominal frequency f_N	-	-	-
Rated current I_n	125 A	200 A	300 A
Max. required back-up fuse	-	-	-
RCM data			
Rated response differential current I_{dyn}	3 A	3 A	3 A
Differential current acquisition characteristic	Type B+ (DC up to 100 kHz)	Type B+ (DC up to 100 kHz)	Type B+ (DC up to 100 kHz)
Response differential current $I_{\Delta n}$	0.03 A ... 3 A	0.03 A ... 3 A	0.1 A ... 3 A
Discrimination threshold main alarm	-	-	-
Discrimination threshold pre-alarm	-	-	-
Response time for $2 \times I_{\Delta n}$	-	-	-
Thermal permanent differential current $I_{\Delta th}$	150 A (50 Hz/20 kHz)	150 A (50 Hz/20 kHz)	150 A (50 Hz/20 kHz)
Thermal rated short-time differential current $I_{\Delta th}$	3 kA for 1 s (50 Hz/20 kHz)	3 kA for 1 s (50 Hz/20 kHz)	3 kA for 1 s (50 Hz/20 kHz)
Rated surge voltage resistance U_{imp}	8 kV	8 kV	8 kV
General data			
Connection data solid / stranded / AWG	-	-	-
Maximum permissible outside diameter of cables	23.00 mm	46.00 mm	70.00 mm
Housing material	-	polycarbonate	polycarbonate
Ambient temperature (operation)	-	-20°C ... 65°C	-20°C ... 65°C
Degree of protection	-	IP20	IP20
Test standards	-	DIN EN 62020 / VDE 0663 / DIN EN 60044-1 / VDE 0414 / DIN V VDE V 0664-110	DIN EN 62020 / VDE 0663 / DIN EN 60044-1 / VDE 0414 / DIN V VDE V 0664-110
Test standards	-	-	-
Pollution degree	2	2	2
Surge voltage category	IV	IV	IV
Mounting			
Mounting type	Screw mounting	Screw mounting	Screw mounting
Remote indication contact	-	-	-
Connection data solid / stranded / AWG	-	-	-
Max. operating voltage	-	-	-
Max. operating current	-	-	-

Ordering data

Description	
Evaluation unit	
Current transformer	
20 mm Ø	
30 mm Ø	
35 mm Ø	
70 mm Ø	
105 mm Ø	
140 mm Ø	
210 mm Ø	

Type	Order No.	Pcs. / Pkt.
RCM-B/50/85-264V	2806210	1

Ordering data

Type	Order No.	Pcs. / Pkt.
RCM-B-SCT-35	2806223	1
RCM-B-SCT-70	2806236	1
RCM-B-SCT-105	2806249	1



RCM type A for pulsating DC and AC residual currents with 50/60 Hz



Converter for RCM type A



Converter for RCM type A

Total width 71.6 mm

Total width 32 mm

Total width 33 mm

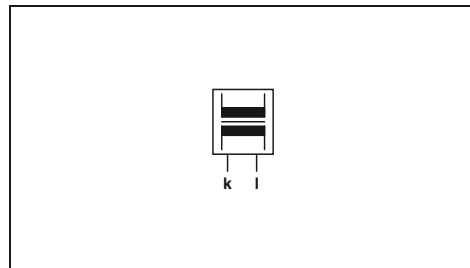
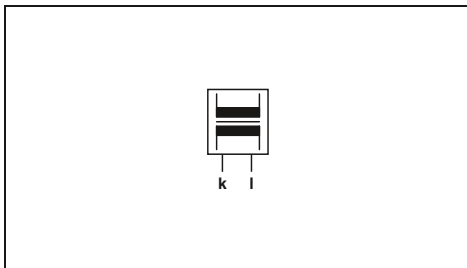
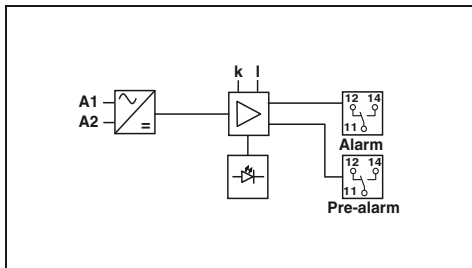

Technical data
85 V AC ... 264 V AC
50 Hz (60 Hz)
-
16 A (B)
3 A
Type A
(50 / 60 Hz)
30, 100, 300, 1000, 3000 mA (adjustable)
80% ... 100% (of the set response differential current $I_{\Delta n}$)
10% ... 90% (of the main alarm threshold, adjustable)
0.1 s ... 1 s (adjustable)
-
4 kV
0.2 ... 4 mm ² / 0.2 ... 2.5 mm ² / 24 - 12
-
polycarbonate
-25°C ... 65°C
IP20
DIN EN 62020 / DIN EN 60664
-
2
III
DIN rail: 35 mm
PDT contact
0.2 ... 4 mm ² / 0.2 ... 2.5 mm ² / -
230 V AC
5 A (cos phi > 0.9)

Technical data				
...SCT-20	...SCT-30	...SCT-35	...SCT-70	
-	-	-	-	
50 A	100 A	125 A	200 A	
-	-	-	-	
3 A	3 A	3 A	3 A	
Type A	Type A	Type A	Type A	
(50 / 60 Hz)	(50 / 60 Hz)	(50 / 60 Hz)	(50 / 60 Hz)	
0.03 A ... 3 A	0.03 A ... 3 A	0.03 A ... 3 A	0.03 A ... 3 A	
-	-	-	-	
-	-	-	-	
1.5 x I_n	1.5 x I_n	1.5 x I_n	1.5 x I_n	
10 x I_n (for 1 s)	10 x I_n (for 1 s)	10 x I_n (for 1 s)	10 x I_n (for 1 s)	
8 kV	8 kV	8 kV	8 kV	
0.2 ... 4 mm ² / 0.2 ... 2.5 mm ² / 24 - 12	0.2 ... 4 mm ² / 0.2 ... 2.5 mm ² / 24 - 12	0.2 ... 4 mm ² / 0.2 ... 2.5 mm ² / 24 - 12	0.2 ... 4 mm ² / 0.2 ... 2.5 mm ² / 24 - 12	
13.00 mm	20.00 mm	23.00 mm	46.00 mm	
polycarbonate	polycarbonate	polycarbonate	polycarbonate	
-20°C ... 65°C	-20°C ... 65°C	-20°C ... 65°C	-20°C ... 65°C	
IP20 (terminal blocks)	IP20 (terminal blocks)	IP20 (terminal blocks)	IP20 (terminal blocks)	
DIN EN 62020 / VDE 0663 / DIN EN 60044-1 / VDE 0414	DIN EN 62020 / VDE 0663 / DIN EN 60044-1 / VDE 0414	DIN EN 62020 / VDE 0663 / DIN EN 60044-1 / VDE 0414	DIN EN 62020 / VDE 0663 / DIN EN 60044-1 / VDE 0414	
2	2	2	2	
IV	IV	IV	IV	
DIN rail: 35 mm	DIN rail: 35 mm	Screw mounting	Screw mounting	
-	-	-	-	
-	-	-	-	
-	-	-	-	

Technical data		
...SCT-105	...SCT-140	...SCT-210
-	-	-
250 A	350 A	400 A
-	-	-
3 A	3 A	3 A
Type A	Type A	Type A
(50 / 60 Hz)	(50 / 60 Hz)	(50 / 60 Hz)
0.03 A ... 3 A	0.03 A ... 3 A	0.03 A ... 3 A
-	-	-
-	-	-
1.5 x I_n	1.5 x I_n	1.5 x I_n
10 x I_n (for 1 s)	10 x I_n (for 1 s)	10 x I_n (for 1 s)
8 kV	8 kV	8 kV
0.2 ... 4 mm ² / 0.2 ... 2.5 mm ² / 24 - 12	0.2 ... 4 mm ² / 0.2 ... 2.5 mm ² / 24 - 12	0.2 ... 4 mm ² / 0.2 ... 2.5 mm ² / 24 - 12
70.00 mm	93.00 mm	140.00 mm
polycarbonate	polycarbonate	polycarbonate
-20°C ... 65°C	-20°C ... 65°C	-20°C ... 65°C
IP20 (terminal blocks)	IP20 (terminal blocks)	IP20 (terminal blocks)
DIN EN 62020 / VDE 0663 / DIN EN 60044-1 / VDE 0414	DIN EN 62020 / VDE 0663 / DIN EN 60044-1 / VDE 0414	DIN EN 62020 / VDE 0663 / DIN EN 60044-1 / VDE 0414
2	2	2
IV	IV	IV
Screw mounting	Screw mounting	Screw mounting
-	-	-
-	-	-

Ordering data		
Type	Order No.	Pcs. / Pkt.
RCM-A/50/85-264V	2806016	1

Ordering data		
Type	Order No.	Pcs. / Pkt.
RCM-A-SCT- 20	2806045	1
RCM-A-SCT- 30	2806058	1
RCM-A-SCT- 35	2806061	1
RCM-A-SCT- 70	2806074	1

Ordering data		
Type	Order No.	Pcs. / Pkt.
RCM-A-SCT-105	2806087	1
RCM-A-SCT-140	2806090	1
RCM-A-SCT-210	2806100	1



EV Charge Control charging controller

EV Charge Control is the charging controller used to charge electric vehicles on the AC mains according to IEC 61851-1.

The control and monitoring functions that are defined here for charging mode 3 serve as the basis for the equipment.

- Control Pilot evaluation and control
- Monitoring of the PE protective ground connection
- Evaluation of the proximity
- Control of the charge contactor and locking actuators

Plug-in charging systems

For information on plug-in charging systems, see Catalog 2, connection technology for field devices.

Additional functions:

All necessary control functions are integrated in a single device. No additional controller is required.

- Easy configuration directly at the device or via the integrated web server
- Adjustable charging current limitation of 6 ... 80 A
- Parameterizable automatic rejection of charging cables with low current carrying capacity
- Automatic or manual locking as well as selection of DC motor or magnetic locking actuators
- Optional locking confirmation and external enabling as a switching requirement
- Integration into your charging infrastructure via Ethernet interface (Modbus/TCP)
- Charging process enabling, status requests, and dynamic load management via remote access
- 4 digital inputs and 4 digital outputs
- Two digital outputs configurable via web server
- 4 relay outputs

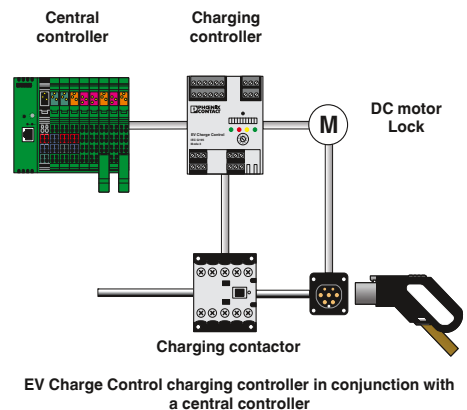
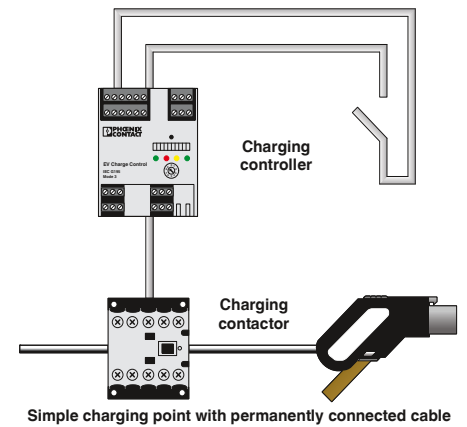

EV Charge Control charging controller

EV Charge Control

- Charging controller for charging electric vehicles on AC mains according to IEC 61851-1.

EV Charge Lock Release

- Optional extension module for plug release in the event of mains failure.

Notes:

For information on plug-in charging systems, see Catalog 2, connection technology for field devices.

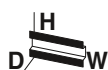

Charging controller



Mains power failure plug enable

Housing width 71.6 mm

Technical data

Input	
Description of the input	Digital input
Nominal input voltage U_N	24 V
Input current	8 mA (24 V)
Input ranges	-3 V ... 5 V (Off) 15 V ... 30 V (On)
Switching output	
Output description	Relay output $C_{1,2}$ and $V_{1,2}$
Maximum switching voltage	250 V AC
Maximum switching current	6 A
Switching output	
Output description	Relay output $R_{1,3}$ and $R_{2,4}$
Maximum switching voltage	30 V AC/DC
Maximum switching current	6 A
Switching output	
Output description	Digital output
Maximum output voltage	30 V
Maximum output current	0.6 A
Ethernet interface	
Connection method	RJ45 socket
Transmission speed	10/100 Mbps
Transmission length	100 m (with shielded, twisted-pair data cable)
General data	
Supply voltage	
Supply voltage range	110 V AC ... 240 V AC (nominal voltage range) 95 V AC ... 264 V AC
Maximum current consumption	40 mA
Own current consumption	-
Frequency range	45 Hz ... 65 Hz
Degree of protection	IP20
Ambient temperature range	-25°C ... 60°C
Dimensions W / H / D	71.6 / 61 / 90 mm
Screw connection solid / stranded / AWG	0.2 ... 4 mm ² / 0.2 ... 2.5 mm ² / 24 - 12
Conformance / approvals	
Conformance	CE-compliant

Housing width 35.6 mm

Technical data

Signal input	
12 V	
Approx. 5 mA (at 12 V)	
-3 V ... 3 V (Off)	
-30 V ... -10 V (Locking ON)	
10 V ... 30 V (Unlocking ON)	
Relay output	
Approx. 11.5 V (Operating/capacitor voltage minus the diode voltage of ~ 0.5 V)	
4 A	
-	
-	
-	
-	
-	
-	
-	
-	
-	
-	
-	
12 V DC ±5%	
-	
-	
4 A (4 mA in idle state)	
-	
IP20	
-25°C ... 60°C	
35.6 / 61 / 90 mm	
0.2 ... 4 mm ² / 0.2 ... 2.5 mm ² / 24 - 12	
CE-compliant	

Ordering data

Description	Type	Order No.	Pcs. / Pkt.
EV Charge Control charging controller	EM-CP-PP-ETH	2902802	1
Mains failure plug release EV Charge Lock Release			

Ordering data

Type	Order No.	Pcs. / Pkt.
EM-EV-CLR-12V	2903246	1



For high system availability

EMD monitoring relays can be used to detect deviations in important system parameters at an early stage. These can be indicated or system parts can be shut down selectively. EMD monitoring relays ensure error-free and cost-effective operation of your system. They are an inexpensive solution for numerous monitoring functions.

- Surge voltage and undervoltage
- Overcurrent and undercurrent
- Phase failure, phase sequence, and phase asymmetry
- Power factor and real power
- Motor winding temperature
- Levels

For system monitoring, choose from two product ranges: compact or multifunctional monitoring relays.

Perfect timing

ETD timer relays ensure optimum time sequences.

The modules are the cost-effective alternative to a PLC: with easy configuration and fast wiring.

Choose from two product ranges for your ideal time control application:

- Ultra-narrow timer relays each with one time range and one function
- Multifunctional timer relays with selectable time ranges and functions

Professionally packaged components

Special function modules with professional housing and connection technology can be used to integrate electronic components in your system. They can be used to perform a variety of tasks:

- Diode modules provide protection against polarity reversal. In addition, they decouple messages in fault reporting systems.
- Lamp testing modules decouple signals in isolation in the field of fault reporting technology.
- Display modules simplify troubleshooting and provide help for monitoring processes.



Compact monitoring relays

- Ideal for simple monitoring tasks – from series production to building installation.
- Compact installation housing
 - Quick and tool-free wiring with push-in technology
 - Parameters can be adjusted easily using rotary switches
 - Clear diagnostics, thanks to color status LED



Multifunctional monitoring relays

- Parameters can be adjusted easily using rotary switches
- Fast error detection, thanks to fine tuning and short response times
- Worldwide use, thanks to wide-range power supply unit or plug-in transformer
- Space saving – with two PDT outputs in 22.5 mm wide housing
- Electrically isolated measuring and supply circuits
- Clear diagnostics, thanks to color status LEDs



Ultra-narrow timer relays

- The space-saving and inexpensive solution for simple time control applications.
- Each with one time range and one function
 - Design width of just 6.2 mm - saves up to 70% space compared to conventional timer relays
 - Precise time setting using the illuminated thumbwheel
 - Fast wiring through the use of plug-in bridges



Multifunctional timer relays

- For universal use thanks to wide range of functions.
- Just three versions for all conventional time control applications.
 - Two floating PDT outputs on a design width of just 22.5 mm
 - Supply voltage via wide-range power supply unit
 - Optimum setting of times ranging from milliseconds to several days



Special function modules

- Special function modules transform components such as diodes into a shock-proof and dust-proof electronics module.
- Easy installation, thanks to electronics housing with IP20 protection that can be installed in a control cabinet
 - Fast mounting on DIN rails, thanks to the foot catch
 - User-friendly wiring, thanks to practical connection technology

Monitoring

Monitoring relays, timer relays, special function modules

Single-phase current and voltage monitoring

Single-phase current monitoring

- The **EMD-BL-C-10** monitors AC currents from 0 ... 10 A.
- Adjustable response delay
- 0 ... 5 A or 0 ... 10 A measuring range
- Adjustable via rotary switch on the front

Single-phase voltage monitoring

- The **EMD-BL-V-230** monitors DC and AC voltages.
- 24 V AC/DC or 230 V AC
- Separately adjustable response delay
- Adjustable monitoring range
- Adjustable via potentiometer on the front



Current monitoring, 1-phase
Overcurrent, undercurrent, window



Voltage monitoring, 1-phase
Undervoltage, window

Housing width 17.5 mm

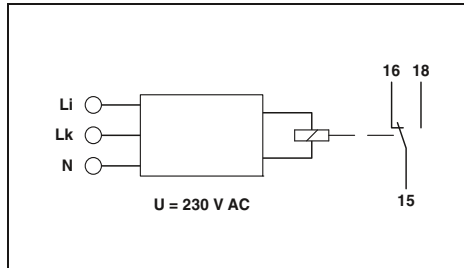

Technical data

Overcurrent, undercurrent, window

0 A ... 5 A AC
0 A ... 10 A AC
(Configurable via rotary switches)
3 mΩ
5% ... 95% (From I_N)
10% ... 100% (From I_N)
0.1 s ... 10 s
≤ 5% (of the nominal value)
±5% (of the nominal value)
≤ 2%

1 floating PDT
1250 VA (5 A/250 V AC)
1 x 10⁵ cycles
15 x 10⁶ cycles
5 A (fast-blow)

230 V AC ±15%
5 VA (0.8 W)

Degree of protection IP40 (housing) / IP20 (connection terminal blocks)

Ambient temperature range -25°C ... 55°C
Dimensions W / H / D 17.5 / 88 / 65.5 mm
Connection data solid / stranded / AWG 0.5 ... 2.5 mm² / 0.5 ... 2.5 mm² / 20 - 14

Conformance / approvals CE-compliant

Ordering data

Description

Compact monitoring relays with push-in connection

Compact monitoring relays with screw connection

Type	Order No.	Pcs. / Pkt.
EMD-BL-C-10-PT	2903522	1
EMD-BL-C-10	2903521	1

Housing width 17.5 mm

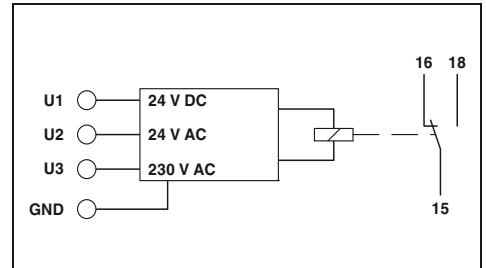

Technical data

Undervoltage, window

0 V DC ... 24 V DC (connection terminal blocks: U1 and GND)
0 V AC ... 24 V AC (connection terminal blocks: U2 and GND)
0 V AC ... 230 V AC (connection terminal blocks: U3 and GND)

-
75% ... 115% (From U_N)
80% ... 120% (From U_N)
0.1 s ... 10 s
≤ 5% (of scale end value)
±5% (of scale end value)
≤ 2%

1 floating PDT
1250 VA (5 A/250 V AC)
1 x 10⁵ cycles
15 x 10⁶ cycles
5 A (fast-blow)

-25% ... +20% (= measuring voltage)
10 VA (At 230 V AC (0.6 W))
1.3 VA (At 24 V AC (0.8 W))
0.6 W (at 24 V DC)

IP40 (housing) / IP20 (connection terminal blocks)

Ambient temperature range -25°C ... 55°C
Dimensions W / H / D 17.5 / 88 / 65.5 mm
Connection data solid / stranded / AWG 0.5 ... 2.5 mm² / 0.5 ... 2.5 mm² / 20 - 14

Conformance / approvals CE-compliant

Ordering data

Type	Order No.	Pcs. / Pkt.
EMD-BL-V-230-PT	2903524	1
EMD-BL-V-230	2903523	1

Three-phase voltage monitoring, phase monitoring

Three-phase voltage monitoring

The **EMD-BL-3V-400** monitors three-phase AC voltages.

- 3~ 400 V AC/230 V AC ±30%
- Separately adjustable response delay
- Adjustable monitoring range
- Adjustable via potentiometer on the front
- Supply from the measuring circuit

Phase monitoring

The **EMD-BL-PH-400** monitors three-phase AC voltages.

- 3~ 208 ... 480 V AC/120 ... 277 V AC
- Adjustable response delay
- Adjustable asymmetry: 5 ... 25%/OFF
- Adjustable via potentiometer on the front
- Supply from the measuring circuit



Voltage monitoring, 3-phase
Window, phase sequence



Phase monitoring
Phase sequence, phase failure, asymmetry

Housing width 17.5 mm

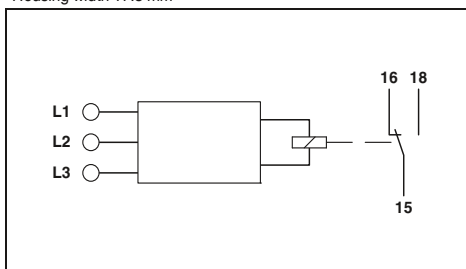

Housing width 17.5 mm

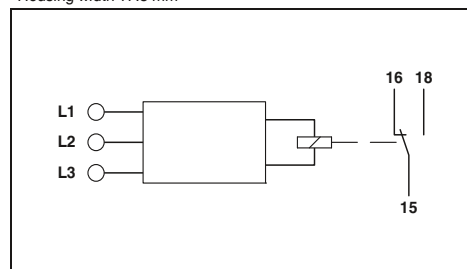

Technical data

Window, phase sequence

280 V AC ... 519 V AC
3~ 400/230 V
-
70% ... 120% (From U_N)
80% ... 130% (From U_N)
0.1 s ... 10 s
-
≤ 5% (of the nominal value)
±5% (of scale end value)
≤ 2%

Ordering data

Type	Order No.	Pcs. / Pkt.
EMD-BL-3V-400-PT	2903526	1
EMD-BL-3V-400	2903525	1

Technical data

Phase sequence, phase failure, asymmetry

187 V AC ... 519 V AC
3~ 208 ... 480 V/120 ... 277 V
-
-
-
0.1 s ... 10 s
5% ... 25% / OFF
≤ 5% (of scale end value)
±5% (of scale end value)
≤ 2%

Ordering data

Type	Order No.	Pcs. / Pkt.
EMD-BL-PH-480-PT	2903528	1
EMD-BL-PH-480	2903527	1

Functions

Input

Monitoring range
Input ranges
Input resistance
Min. setting range
Max. setting range
Setting range for response delay
Asymmetry
Basic accuracy
Setting accuracy
Repeat accuracy

Relay output

Contact type
Switching capacity
Electrical service life
Mechanical service life
Output fuse

General data

Supply voltage
Nominal power consumption

Degree of protection

Ambient temperature range

Dimensions W / H / D

Connection data solid / stranded / AWG

Conformance / approvals

Conformance

Description

Compact monitoring relays with push-in connection

Compact monitoring relays with screw connection

Monitoring

Monitoring relays, timer relays, special function modules

Single-phase current monitoring

EMD-...C... monitoring relays monitor DC and AC currents within the range 0 ... 10 A.

- Separately adjustable startup and release delays
- Variable supply voltage range
- Adjustable via potentiometer on front

Notes:

1) EMC: Class A product, see page 571

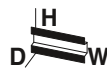

Overcurrent and undercurrent monitoring



Overcurrent or undercurrent monitoring



Housing width 22.5 mm

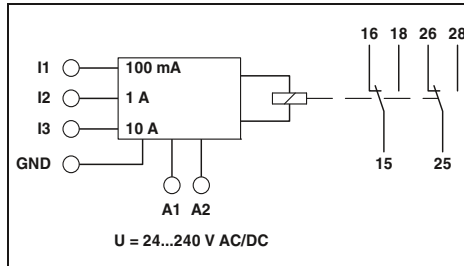

Technical data

Functions	Overcurrent, undercurrent, window, error memory
Input	0 mA ... 100 mA AC/DC (Connection terminals: I1 and GND) 0 A ... 1 A AC/DC (Connection terminals: I2 and GND) 0 A ... 10 A AC/DC (Connection terminals: I3 and GND)
Input ranges	470 mΩ (at I _N = 100 mA) ; 47 mΩ (at I _N = 1 A) ; 5 mΩ (at I _N = 10 A)
Input resistance	470 mΩ (at I _N = 100 mA) ; 47 mΩ (at I _N = 1 A) ; 5 mΩ (at I _N = 10 A)
Min. setting range	5% ... 95% (From I _N)
Max. setting range	10% ... 100% (From I _N)
Setting range for response delay	0.1 s ... 10 s
Setting range for starting delay	0 s ... 10 s
Basic accuracy	±5% (of scale end value)
Setting accuracy	≤ 5% (of scale end value)
Repeat accuracy	≤ 2%
Relay output	2 floating PDT contacts
Contact type	750 VA (3 A/250 V AC, module aligned, ≤ 5 mm spacing) 1250 VA (5 A/250 V AC, module not aligned, ≥ 5 mm spacing)
Switching capacity	1250 VA (5 A/250 V AC, module not aligned, ≥ 5 mm spacing)
Electrical service life	2 x 10 ⁵ cycles at ohmic load, 1000 VA
Mechanical service life	Approx. 2 x 10 ⁷ cycles
Output fuse	5 A (fast-blow)
General data	
Supply voltage	4.5 VA (1.5 W)
Nominal power consumption	IP40 (housing) / IP20 (connection terminal blocks)
Degree of protection	-25°C ... 55°C
Ambient temperature range	22.5 / 90 / 113 mm
Dimensions W / H / D	0.5 ... 2.5 mm ² / 0.25 ... 2.5 mm ² / 20 - 14
Screw connection solid / stranded / AWG	
Conformance / approvals	CE-compliant UL/C-UL listed UL 508

Ordering data

Description	Type	Order No.	Pcs. / Pkt.
Electronic monitoring relay	EMD-FL-C-10 ¹⁾	2866022	1
Power module, plug-in, please order at the same time!			
Supply voltage 20 ... 30 V DC			
Supply voltage 20.2 ... 26.4 V AC			
Supply voltage 88 ... 121 V AC			
Supply voltage 108 ... 132 V AC			
Supply voltage 195 ... 264 V AC			



Housing width 22.5 mm

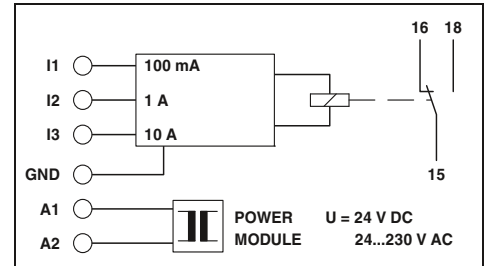

Technical data

EMD-SL-C-OC-10	EMD-SL-C-UC-10
Overcurrent	Undercurrent
0 mA ... 100 mA AC/DC (Connection terminals: I1 and GND) 0 A ... 1 A AC/DC (Connection terminals: I2 and GND) 0 A ... 10 A AC/DC (Connection terminals: I3 and GND)	0 mA ... 100 mA AC/DC (Connection terminals: I1 and GND) 0 A ... 1 A AC/DC (Connection terminals: I2 and GND) 0 A ... 10 A AC/DC (Connection terminals: I3 and GND)
470 mΩ (at I _N = 100 mA) ; 47 mΩ (at I _N = 1 A) ; 5 mΩ (at I _N = 10 A)	470 mΩ (at I _N = 100 mA) ; 47 mΩ (at I _N = 1 A) ; 5 mΩ (at I _N = 10 A)
5% ... 95% (From I _N)	5% ... 95% (From I _N)
10% ... 100% (From I _N)	10% ... 100% (From I _N)
0.2 s ... 10 s	0.2 s ... 10 s
-	-
±5% (of scale end value)	±5% (of scale end value)
≤ 5% (of scale end value)	≤ 5% (of scale end value)
≤ 2%	≤ 2%
1 floating PDT	1 floating PDT
750 VA (3 A/250 V AC, module aligned, ≤ 5 mm spacing) 1250 VA (5 A/250 V AC, module not aligned, ≥ 5 mm spacing)	750 VA (3 A/250 V AC, module aligned, ≤ 5 mm spacing) 1250 VA (5 A/250 V AC, module not aligned, ≥ 5 mm spacing)
2 x 10 ⁵ cycles at ohmic load, 1000 VA	2 x 10 ⁵ cycles at ohmic load, 1000 VA
Approx. 2 x 10 ⁷ cycles	Approx. 2 x 10 ⁷ cycles
5 A (fast-blow)	5 A (fast-blow)
2 VA (1.5 W)	2 VA (1.5 W)
IP40 (housing) / IP20 (connection terminal blocks)	IP40 (housing) / IP20 (connection terminal blocks)
-25°C ... 55°C	-25°C ... 55°C
22.5 / 90 / 113 mm	22.5 / 90 / 113 mm
0.5 ... 2.5 mm ² / 0.25 ... 2.5 mm ² / 20 - 14	0.5 ... 2.5 mm ² / 0.25 ... 2.5 mm ² / 20 - 14
CE-compliant	CE-compliant
UL/C-UL listed UL 508	UL/C-UL listed UL 508

Ordering data

Type	Order No.	Pcs. / Pkt.
EMD-SL-C-OC-10	2866019	1
EMD-SL-C-UC-10	2867937	1
EMD-SL-PS- 24DC	2885359	1
EMD-SL-PS- 24AC	2866103	1
EMD-SL-PS-110AC	2866116	1
EMD-SL-PS-120AC	2885731	1
EMD-SL-PS-230AC	2866129	1

Single-phase voltage monitoring

- EMD-...V...** monitoring relays monitor DC and AC voltages within the range 0 ... 300 V.
- Separately adjustable startup and release delays
 - Variable supply voltage range
 - Adjustable via potentiometer on front

Notes:
1) EMC: Class A product, see page 571



Undervoltage and overvoltage monitoring



Undervoltage monitoring

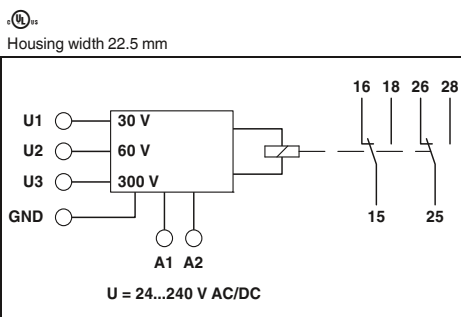

Technical data

Functions	Undervoltage, overvoltage, window, error memory
Input	0 V ... 30 V AC/DC (connection terminal blocks: U1 and GND) 0 V ... 60 V AC/DC (connection terminal blocks: U2 and GND) 0 V ... 300 V AC/DC (connection terminal blocks: U3 and GND)
Input ranges	47 kΩ (connection terminal blocks: U1 and GND) 100 kΩ (connection terminal blocks: U2 and GND) 470 kΩ (connection terminal blocks: U3 and GND)
Input resistance	5% ... 95% (From U _N) 10% ... 100% (From U _N) 0.1 s ... 10 s 0 s ... 10 s
Min. setting range	±5% (of scale end value)
Max. setting range	≤ 5% (of scale end value)
Setting range for response delay	≤ 2%
Setting range for starting delay	2 floating PDT contacts 750 VA (3 A/250 V AC, module aligned, ≤ 5 mm spacing) 1250 VA (5 A/250 V AC, module not aligned, ≥ 5 mm spacing)
Basic accuracy	2 x 10 ⁵ cycles at ohmic load, 1000 VA
Setting accuracy	Approx. 2 x 10 ⁷ cycles
Repeat accuracy	5 A (fast-blow)
Relay output	4.5 VA (1.5 W)
Contact type	IP40 (housing) / IP20 (connection terminal blocks)
Switching capacity	-25°C ... 55°C
Electrical service life	22.5 / 90 / 113 mm
Mechanical service life	0.5 ... 2.5 mm ² / 0.25 ... 2.5 mm ² / 20 - 14
Output fuse	CE-compliant
General data	UL/C-UL listed UL 508
Supply voltage	
Nominal power consumption	
Degree of protection	
Ambient temperature range	
Dimensions W / H / D	
Screw connection solid / stranded / AWG	
Conformance / approvals	
Conformance	
UL, USA / Canada	

Ordering data

Type	Order No.	Pcs. / Pkt.
EMD-FL-V-300 ¹⁾	2866048	1

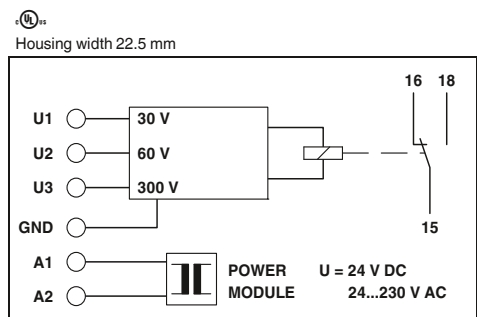

Technical data

Functions	Undervoltage
Input	0 V ... 30 V AC/DC (connection terminal blocks: U1 and GND) 0 V ... 60 V AC/DC (connection terminal blocks: U2 and GND) 0 V ... 300 V AC/DC (connection terminal blocks: U3 and GND)
Input ranges	47 kΩ (connection terminal blocks: U1 and GND) 100 kΩ (connection terminal blocks: U2 and GND) 470 kΩ (connection terminal blocks: U3 and GND)
Input resistance	5% ... 95% (From U _N) 10% ... 100% (From U _N) 0.2 s ... 10 s -
Min. setting range	±5% (of scale end value)
Max. setting range	≤ 5% (of scale end value)
Setting range for response delay	≤ 2%
Setting range for starting delay	1 floating PDT 750 VA (3 A/250 V AC, module aligned, ≤ 5 mm spacing) 1250 VA (5 A/250 V AC, module not aligned, ≥ 5 mm spacing)
Basic accuracy	2 x 10 ⁵ cycles at ohmic load, 1000 VA
Setting accuracy	Approx. 2 x 10 ⁷ cycles
Repeat accuracy	5 A (fast-blow)
Relay output	2 VA (1.5 W)
Contact type	IP40 (housing) / IP20 (connection terminal blocks)
Switching capacity	-25°C ... 55°C
Electrical service life	22.5 / 90 / 113 mm
Mechanical service life	0.5 ... 2.5 mm ² / 0.25 ... 2.5 mm ² / 20 - 14
Output fuse	CE-compliant
General data	UL/C-UL listed UL 508
Supply voltage	
Nominal power consumption	
Degree of protection	
Ambient temperature range	
Dimensions W / H / D	
Screw connection solid / stranded / AWG	
Conformance / approvals	
Conformance	
UL, USA / Canada	

Ordering data

Type	Order No.	Pcs. / Pkt.
EMD-SL-V-UV-300	2866035	1
EMD-SL-PS- 24DC	2885359	1
EMD-SL-PS- 24AC	2866103	1
EMD-SL-PS-110AC	2866116	1
EMD-SL-PS-120AC	2885731	1
EMD-SL-PS-230AC	2866129	1

Description
Electronic monitoring relay
Power module, plug-in, please order at the same time!
Supply voltage 20 ... 30 V DC
Supply voltage 20.2 ... 26.4 V AC
Supply voltage 88 ... 121 V AC
Supply voltage 108 ... 132 V AC
Supply voltage 195 ... 264 V AC

Monitoring

Monitoring relays, timer relays, special function modules

Three-phase voltage monitoring

EMD-...-3V... monitoring relays monitor three-phase AC voltages of 160 ... 897 V AC (depending on the device concerned).

- Adjustable response delay
- Variable supply voltage range
- Adjustable via potentiometer on front
- Adjustable asymmetry

Notes:
1) EMC: Class A product, see page 571

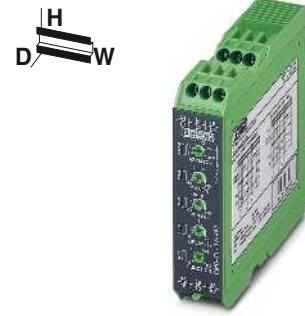

Undervoltage and phase monitoring, 400 V or 230 V



Housing width 22.5 mm

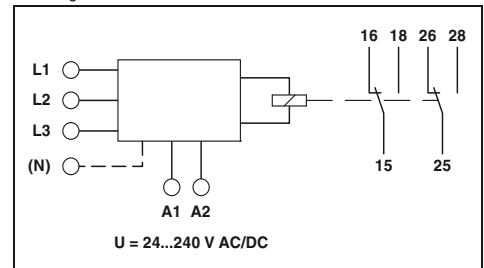

Technical data

Functions	EMD-FL-3V-400(1) Undervoltage, window, asymmetry, phase sequence, phase failure	EMD-FL-3V-230(1) Undervoltage, window, asymmetry, phase sequence, phase failure
Input		
Monitoring range	280 V AC ... 520 V AC	161 V AC ... 299 V AC
Input ranges	3 N ~ 400/230 V	3 N ~ 230/132 V
Input resistance	1 MΩ	470 kΩ
Min. setting range	-30% ... 20% (From U _N)	
Max. setting range	-20% ... 30% (From U _N)	
Setting range for response delay	0.1 s ... 10 s	
Asymmetry	5% ... 25% / OFF	5% ... 25% / OFF
Basic accuracy	±5% (of scale end value)	
Setting accuracy	≤ 5% (of scale end value)	
Repeat accuracy	≤ 2%	
Relay output		
Contact type	2 floating PDT contacts	
Switching capacity	750 VA (3 A/250 V AC, module aligned, ≤ 5 mm spacing) 1250 VA (5 A/250 V AC, module not aligned, ≥ 5 mm spacing)	
Electrical service life	2 x 10 ⁵ cycles at ohmic load, 1000 VA	
Mechanical service life	Approx. 2 x 10 ⁷ cycles	
Output fuse	5 A (fast-blow)	
General data		
Supply voltage	4,5 VA (1.5 W)	
Nominal power consumption	IP40 (housing) / IP20 (connection terminal blocks)	
Degree of protection	-25°C ... 55°C	
Ambient temperature range	22.5 / 90 / 113 mm	
Dimensions W / H / D	0.5 ... 2.5 mm ² / 0.25 ... 2.5 mm ² / 20 - 14	
Screw connection solid / stranded / AWG		
Conformance / approvals		
Conformance	CE-compliant	
UL, USA / Canada	UL/C-UL listed UL 508	

Ordering data

Description	Type	Order No.	Pcs. / Pkt.
Electronic monitoring relay			
Power module, plug-in, please order at the same time!			
Supply voltage 20 ... 30 V DC	EMD-FL-3V-400(1)	2866064	1
Supply voltage 20.2 ... 26.4 V AC	EMD-FL-3V-230(1)	2885773	1
Supply voltage 88 ... 121 V AC			
Supply voltage 108 ... 132 V AC			
Supply voltage 195 ... 264 V AC			
Supply voltage 323 ... 456 V AC			

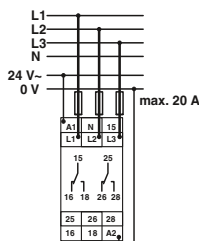

Connection example



**Undervoltage and phase monitoring,
500 V or 690 V**



**Undervoltage/overvoltage monitoring,
400 V with/without neutral conductor**



Phase monitoring, 400 V

Housing width 45 mm

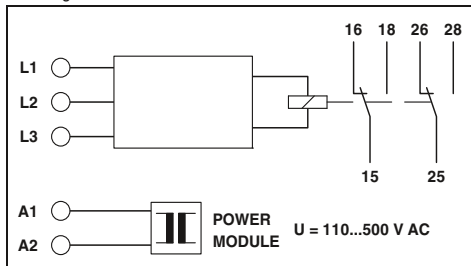

Technical data

EMD-FL-3V-690 Undervoltage, window, asymmetry, phase sequence, phase failure	EMD-FL-3V-500 Undervoltage, window, asymmetry, phase sequence, phase failure
--	--

483 V AC ... 897 V AC 3 ~ 690 V 1 MΩ -30% ... 20% (From U_N) -20% ... 30% (From U_N) 0.1 s ... 10 s 5% ... 25% / OFF ±5% (of scale end value) ≤ 5% (of scale end value) ≤ 2%	350 V AC ... 650 V AC 3 ~ 500 V 1 MΩ -30% ... 20% (From U_N) -20% ... 30% (From U_N) 0.1 s ... 10 s 5% ... 25% / OFF ±5% (of scale end value) ≤ 5% (of scale end value) ≤ 2%
---	---

2 floating PDT contacts
750 VA (3 A/250 V AC, module aligned, ≤ 5 mm spacing)
1250 VA (5 A/250 V AC, module not aligned, ≥ 5 mm spacing)

2 x 10⁶ cycles at ohmic load, 1000 VA
Approx. 2 x 10⁷ cycles
5 A (fast-blow)

4.5 VA (1.5 W)
IP40 (housing) / IP20 (connection terminal blocks)
-25°C ... 55°C
45 / 90 / 113 mm
0.5 ... 2.5 mm² / 0.25 ... 2.5 mm² / 20 - 14

CE-compliant
UL/C-UL listed UL 508

Ordering data

Type	Order No.	Pcs. / Pkt.
EMD-FL-3V-690	2885249	1
EMD-FL-3V-500	2867979	1
EMD-SL-PS45-110AC	2885281	1
EMD-SL-PS45-120AC	2885744	1
EMD-SL-PS45-230AC	2885294	1
EMD-SL-PS45-400AC	2885304	1

Housing width 22.5 mm

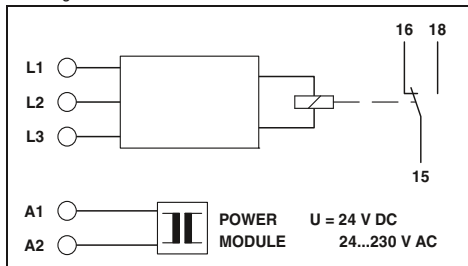

Technical data

EMD-SL-3V-400 Window, without neutral conductor connection	EMD-SL-3V-400-N Window, with neutral conductor connection
--	---

280 V AC ... 520 V AC 3 ~ 400 V 1 MΩ -30% ... 20% (From U_N) -20% ... 30% (From U_N) 0.2 s ... 10 s ±5% (of scale end value) ≤ 5% (of scale end value) ≤ 2%	280 V AC ... 520 V AC 3 N ~ 400/230 V 1 MΩ -30% ... 20% (From U_N) -20% ... 30% (From U_N) 0.2 s ... 10 s ±5% (of scale end value) ≤ 5% (of scale end value) ≤ 2%
---	---

1 floating PDT
750 VA (3 A/250 V AC, module aligned, ≤ 5 mm spacing)
1250 VA (5 A/250 V AC, module not aligned, ≥ 5 mm spacing)

2 x 10⁶ cycles at ohmic load, 1000 VA
Approx. 2 x 10⁷ cycles
5 A (fast-blow)

2 VA (1.5 W)
IP40 (housing) / IP20 (connection terminal blocks)
-25°C ... 55°C
22.5 / 90 / 113 mm
0.5 ... 2.5 mm² / 0.25 ... 2.5 mm² / 20 - 14

CE-compliant
UL/C-UL listed UL 508

Ordering data

Type	Order No.	Pcs. / Pkt.
EMD-SL-3V-400	2866051	1
EMD-SL-3V-400-N	2885278	1
EMD-SL-PS-24DC	2885359	1
EMD-SL-PS-24AC	2866103	1
EMD-SL-PS-110AC	2866116	1
EMD-SL-PS-120AC	2885731	1
EMD-SL-PS-230AC	2866129	1

Housing width 22.5 mm

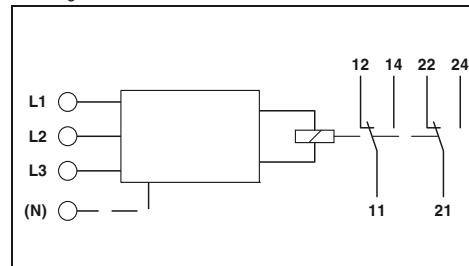

Technical data

Phase sequence, phase failure, asymmetry

342 V AC ...
3 N ~ 400/230 V
15 kΩ
-
≤ 350 ms (fixed setting)
Fixed, approx. 30%
-
-

2 floating PDT contacts
750 VA (3 A/250 V AC, module aligned, ≤ 5 mm spacing)
1250 VA (5 A/250 V AC, module not aligned, ≥ 5 mm spacing)

2 x 10⁶ cycles at ohmic load, 1000 VA
Approx. 2 x 10⁷ cycles
5 A (fast-blow)

(From the measured voltage)
9 VA
IP40 (housing) / IP20 (connection terminal blocks)
-25°C ... 55°C
22.5 / 90 / 113 mm
0.5 ... 2.5 mm² / 0.25 ... 2.5 mm² / 20 - 14

CE-compliant
UL/C-UL listed UL 508

Ordering data

Type	Order No.	Pcs. / Pkt.
EMD-SL-PH-400	2866077	1

Monitoring

Monitoring relays, timer relays, special function modules

Effective power monitoring, load monitoring (cos φ)

Effective power monitoring

The effective power in single- and 3-phase networks can be monitored with the **EMD-FL-RP-480** effective power monitoring relay.

- Monitoring range up to 7.2 kW
- Separately adjustable startup and release delays
- Temperature monitoring of the motor winding
- Variable supply voltage range
- Detection of switched off loads

Load monitoring (cos φ)

The **EMD-FL-PF-400** monitoring relay is a cos φ monitor for load monitoring in single- or three-phase networks.

Notes:

- 1) EMC: Class A product, see page 571

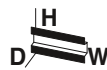

Effective power monitoring



Load monitoring (cos φ)

Housing width 45 mm

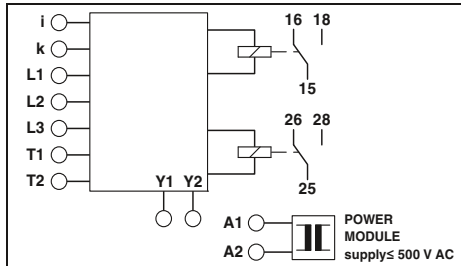

Technical data

Underload, overload, window, winding temperature monitoring

Voltage input
AC sine (10 Hz ... 400 Hz)
Can be switched between 0.75 kW, 1.5 kW, 3 kW and 6 kW

480 V (3 N ~ 480/277 V)
0 V AC ... 480 V AC (1(N) ~, single-phase load)
0 V AC ... 480 V AC (3(N) ~, 3-phase load)
0.15 A ... 6 A (Range: 0.75 kW and 1.5 kW)
0.3 A ... 12 A (Range: 3 kW and 6 kW)
5% ... 110% (of P_N)
10% ... 120% (of P_N)

Min.
Max.

2 floating PDT contacts
750 VA (3 A/250 V AC, module aligned, ≤ 5 mm spacing)
1250 VA (5 A/250 V AC, module not aligned, ≥ 5 mm spacing)

2 x 10⁵ cycles at ohmic load, 1000 VA
Approx. 2 x 10⁷ cycles
5 A (fast-blow)

3.5 VA (3 W)
300 V (According to EN 50178)
IP40 (housing) / IP20 (connection terminal blocks)
-25°C ... 55°C
45 / 90 / 113 mm
0.5 ... 2.5 mm² / 0.25 ... 2.5 mm² / 20 - 14

CE-compliant
UL applied for

Ordering data

Functions
Input
Description of the input
Measured value
Measuring ranges P _N
Nominal input voltage U _N
Input ranges
Input ranges
Min. setting range
Max. setting range
Switching threshold cos φ
Relay output
Contact type
Switching capacity
Electrical service life
Mechanical service life
Output fuse
General data
Supply voltage
Nominal power consumption
Rated insulation voltage
Degree of protection
Ambient temperature range
Dimensions W / H / D
Screw connection solid / stranded / AWG
Conformance / approvals
Conformance
UL, USA / Canada



Housing width 22.5 mm

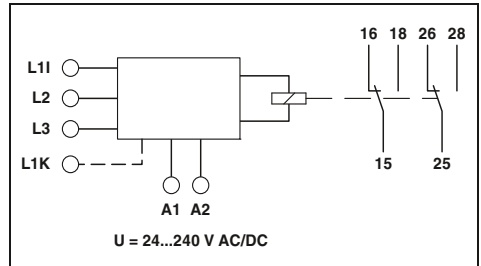

Technical data

Underload, overload, Window

-
AC sine (10 ... 100 Hz)
-

(3 N ~ 415/240 V)
40 V AC ... 415 V AC (1(N) ~, single-phase load)
40 V AC ... 415 V AC (3(N) ~, 3-phase load)
0.5 A ... 10 A (Connection terminal blocks: L1i and L1k)
-
-
0.1 ... 0.99
0.2 ... 1

2 floating PDT contacts
750 VA (3 A/250 V AC, module aligned, ≤ 5 mm spacing)
1250 VA (5 A/250 V AC, module not aligned, ≥ 5 mm spacing)

2 x 10⁵ cycles at ohmic load, 1000 VA
Approx. 2 x 10⁷ cycles
5 A (fast-blow)

4.5 VA (1.5 W)
300 V (According to EN 50178)
IP40 (housing) / IP20 (connection terminal blocks)
-25°C ... 55°C
22.5 / 90 / 113 mm
0.5 ... 2.5 mm² / 0.25 ... 2.5 mm² / 20 - 14

CE-compliant
UL/C-UL listed UL 508

Ordering data

Description
Electronic monitoring relay
Power module, plug-in, please order at the same time!
Supply voltage 88 ... 121 V AC
Supply voltage 108 ... 132 V AC
Supply voltage 195 ... 264 V AC
Supply voltage 323 ... 456 V AC
Supply voltage 425 ... 550 V AC

Type	Order No.	Pcs. / Pkt.
EMD-FL-RP-480	2900177	1
EMD-SL-PS45-110AC	2885281	1
EMD-SL-PS45-120AC	2885744	1
EMD-SL-PS45-230AC	2885294	1
EMD-SL-PS45-400AC	2885304	1
EMD-SL-PS45-500AC	2885317	1

Type	Order No.	Pcs. / Pkt.
EMD-FL-PF-400¹⁾	2885809	1



Temperature monitoring, filling level monitoring

Temperature monitoring (motor winding)

The monitoring relay **EMD-SL-PTC** monitors the motor winding temperatures by means of PTC (PTC thermistor resistance) as per DIN 44081.

- Test function with integrated test/reset button
- Variable supply voltage range
- Short-circuit and open-circuit monitoring

Filling level monitoring

The **EMD-SL-LL-...** monitoring relay monitors the level of electrically conductive liquids with the help of conductive probes (not supplied as standard).

- Adjustable response delay
- Adjustable via potentiometer on front



Temperature monitoring (motor windings)



Filling level monitoring

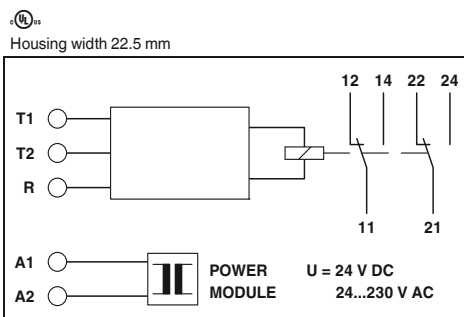

Housing width 22.5 mm

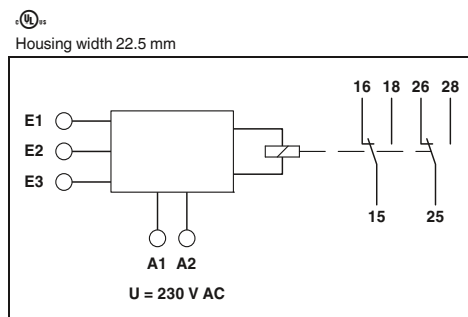

Housing width 22.5 mm

Technical data

Technical data

Functions

Winding temperature monitoring

Pumping up (minimum monitoring),
pumping down (maximum monitoring)

Input

- Total cold resistance
- Response value
- Release value
- Basic accuracy
- Repeat accuracy
- Measuring input
- Max. probe voltage
- Max. probe current
- Length of probe cable

- < 1.5 kΩ
- ≥ 3.6 kΩ (Relay drops out)
- ≤ 1.8 kΩ (Relay picks up)
- ±10% (of scale end value)
- ≤ 2%
-
-
-
-

-
-
-
-
-
- Conductive probe, type: SK1, SK2, SK3
- 16 V AC
- 7 mA
- < 1000 m Set value < 50% (Capacity 100 nF/km)
- < 100 m Set value 100% (Capacity 100 nF/km)

Switching threshold

-

0.25 kΩ ... 100 kΩ (4 mS ... 1 μS)

Relay output

Contact type

Switching capacity

2 floating PDT contacts
750 VA (3 A/250 V AC, module aligned, ≤ 5 mm spacing)
1250 VA (5 A/250 V AC, module not aligned, ≥ 5 mm spacing)

2 floating PDT contacts
750 VA (3 A/250 V AC, module aligned, ≤ 5 mm spacing)
1250 VA (5 A/250 V AC, module not aligned, ≥ 5 mm spacing)

Electrical service life

Mechanical service life

Output fuse

General data

Supply voltage

Nominal power consumption

Degree of protection

Ambient temperature range

Dimensions W / H / D

Screw connection solid / stranded / AWG

Conformance / approvals

Conformance

UL, USA / Canada

2 x 10⁵ cycles at ohmic load, 1000 VA
Approx. 2 x 10⁷ cycles
5 A (fast-blow)
2 VA (1.5 W)
IP40 (housing) / IP20 (connection terminal blocks)
-25°C ... 55°C
22.5 / 90 / 113 mm
0.5 ... 2.5 mm² / 0.25 ... 2.5 mm² / 20 - 14

2 x 10⁵ cycles at ohmic load, 1000 VA
Approx. 2 x 10⁷ cycles
5 A (fast-blow)
EMD-SL-LL-230 EMD-SL-LL-110
230 V AC -15% ... +15% AC 110 V AC -10% ... +15% AC
2 VA (1.5 W)
IP40 (housing) / IP20 (connection terminal blocks)
-25°C ... 55°C
22.5 / 90 / 113 mm
0.5 ... 2.5 mm² / 0.25 ... 2.5 mm² / 20 - 14

CE-compliant
UL/C-UL listed UL 508

CE-compliant
UL/C-UL listed UL 508

Ordering data

Ordering data

Description

Electronic monitoring relay

Power module, plug-in, please order at the same time!

- Supply voltage 20 ... 30 V DC
- Supply voltage 20.2 ... 26.4 V AC
- Supply voltage 88 ... 121 V AC
- Supply voltage 108 ... 132 V AC
- Supply voltage 195 ... 264 V AC

Type	Order No.	Pcs. / Pkt.
EMD-SL-PTC	2866093	1
EMD-SL-PS-24DC	2885359	1
EMD-SL-PS-24AC	2866103	1
EMD-SL-PS-110AC	2866116	1
EMD-SL-PS-120AC	2885731	1
EMD-SL-PS-230AC	2866129	1

Type	Order No.	Pcs. / Pkt.
EMD-SL-LL-230	2885906	1
EMD-SL-LL-110	2901137	1

Ultra-narrow timer relays

The **ETD-BL-1T...** ultra-narrow timer relays show their strengths in applications that involve set parameters for functionality and time range.

- Purposeful device selection: one function, one time range
- High level of setting accuracy thanks to labeled and illuminated thumbwheel
- 6.2 mm slim design width



N

Timer relay with switch-on delay, voltage controlled

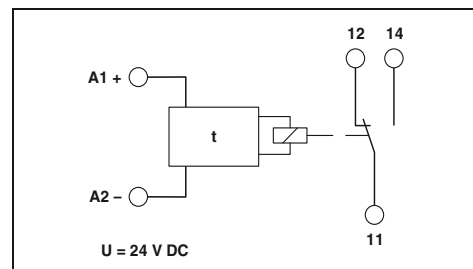

Technical data

Functions	
Control contact	-
Connection	-
Control pulse length	min. 50 ms
Relay output	
Contact type	1 floating PDT
Switching capacity	1500 VA (6 A / 250 V AC)
Mechanical service life	Approx. 2×10^7 cycles
General data	
Supply voltage	24 V DC (19,2 V DC ... 30 V DC)
Nominal current typ.	15 mA (Relay ON) 7 mA (Relay OFF)
Impulse withstand voltage	6 kV (According to EN 50178)
Degree of protection	IP20
Ambient temperature range	-20°C ... 65°C
Housing material	Polyamide PA, self-extinguishing
Dimensions W / H / D	6,2 / 80 / 86 mm
Screw connection solid / stranded / AWG	0,14 ... 2,5 mm ² / 0,14 ... 2,5 mm ² / 26 - 14
Spring-cage connection (solid/stranded/AWG)	0,14 ... 2,5 mm ² / 0,14 ... 2,5 mm ² / 26 - 14
Conformance / approvals	
Conformance	CE-compliant
ATEX	Ex II 3 G Ex nA nC IIC T4 Gc X

ON: With switch-on delay

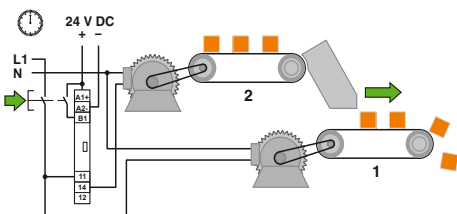

Conveyor belt 1 starts immediately

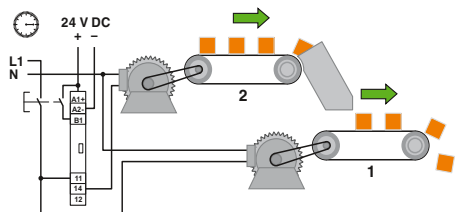

Conveyor belt 2 starts with a time delay

Description	
Compact timer relay, with screw connection	
Time range 0.1...10 s	
Time range 3...300 s	
Time range 0.3...30 min	
Time range 3...300 min	
Compact timer relay, with push-in technology	
Time range 0.1...10 s	
Time range 3...300 s	
Time range 0.3...30 min	
Time range 3...300 min	

Ordering data

Type	Order No.	Pcs. / Pkt.
ETD-BL-1T-ON- 10S	2917379	1
ETD-BL-1T-ON-300S	2917382	1
ETD-BL-1T-ON- 30MIN	2917395	1
ETD-BL-1T-ON-300MIN	2917405	1
ETD-BL-1T-ON- 10S-PT	2901476	1
ETD-BL-1T-ON-300S-PT	2901477	1
ETD-BL-1T-ON- 30MIN-PT	2901478	1
ETD-BL-1T-ON-300MIN-PT	2901479	1



Timer relay with switch-on delay, with control contact



Timer relay with off delay, with control contact



Timer relay with flashing indic. function, beginning with the pulse

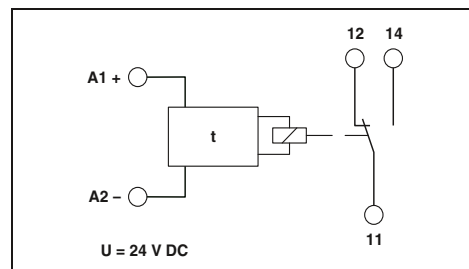
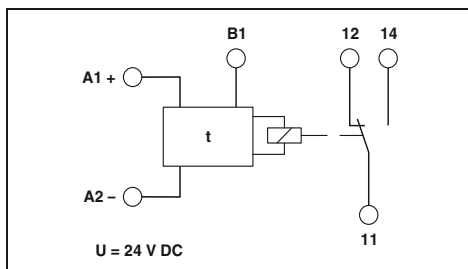
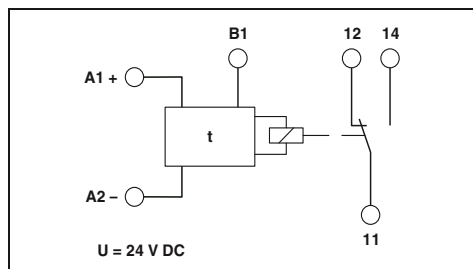

Technical data

Technical data

Technical data

ON-CC: With switch-on delay with control contact

OFF-CC: Off delay with control contact

F: Flashing beginning with pulse

Non-floating, terminals A1-B1
min. 50 ms

Non-floating, terminals A1-B1
min. 50 ms

-
min. 50 ms

1 floating PDT
1500 VA (6 A / 250 V AC)
Approx. 2×10^7 cycles

1 floating PDT
1500 VA (6 A / 250 V AC)
Approx. 2×10^7 cycles

1 floating PDT
1500 VA (6 A / 250 V AC)
Approx. 2×10^7 cycles

24 V DC (19.2 V DC ...30 V DC)
15 mA (Relay ON)
7 mA (Relay OFF)
6 kV (According to EN 50178)
IP20
-20°C ... 65°C
Polyamide PA, self-extinguishing
6.2 / 80 / 86 mm
0.14 ... 2.5 mm² / 0.14 ... 2.5 mm² / 26 - 14
0.14 ... 2.5 mm² / 0.14 ... 2.5 mm² / 26 - 14

24 V DC (19.2 V DC ...30 V DC)
15 mA (Relay ON)
7 mA (Relay OFF)
6 kV (According to EN 50178)
IP20
-20°C ... 65°C
Polyamide PA, self-extinguishing
6.2 / 80 / 86 mm
0.14 ... 2.5 mm² / 0.14 ... 2.5 mm² / 26 - 14
0.14 ... 2.5 mm² / 0.14 ... 2.5 mm² / 26 - 14

24 V DC (19.2 V DC ...30 V DC)
15 mA (Relay ON)
7 mA (Relay OFF)
6 kV (According to EN 50178)
IP20
-20°C ... 65°C
Polyamide PA, self-extinguishing
6.2 / 80 / 86 mm
0.14 ... 2.5 mm² / 0.14 ... 2.5 mm² / 26 - 14
0.14 ... 2.5 mm² / 0.14 ... 2.5 mm² / 26 - 14

CE-compliant
Ex II 3 G Ex nA nC IIC T4 Gc X

CE-compliant
Ex II 3 G Ex nA nC IIC T4 Gc X

CE-compliant
Ex II 3 G Ex nA nC IIC T4 Gc X

Ordering data

Ordering data

Ordering data

Type	Order No.	Pcs. / Pkt.
ETD-BL-1T-ON-CC- 10S	2917418	1
ETD-BL-1T-ON-CC-300S	2917421	1
ETD-BL-1T-ON-CC- 30MIN	2917434	1
ETD-BL-1T-ON-CC-300MIN	2917447	1
ETD-BL-1T-ON-CC- 10S-PT	2901480	1
ETD-BL-1T-ON-CC-300S-PT	2901481	1
ETD-BL-1T-ON-CC- 30MIN-PT	2901483	1
ETD-BL-1T-ON-CC-300MIN-PT	2901484	1

Type	Order No.	Pcs. / Pkt.
ETD-BL-1T-OFF-CC- 10S	2917450	1
ETD-BL-1T-OFF-CC-300S	2917463	1
ETD-BL-1T-OFF-CC- 30MIN	2917467	1
ETD-BL-1T-OFF-CC-300MIN	2917489	1
ETD-BL-1T-OFF-CC- 10S-PT	2901485	1
ETD-BL-1T-OFF-CC-300S-PT	2901486	1
ETD-BL-1T-OFF-CC- 30MIN-PT	2901487	1
ETD-BL-1T-OFF-CC-300MIN-PT	2901488	1

Type	Order No.	Pcs. / Pkt.
ETD-BL-1T-F- 10S	2917492	1
ETD-BL-1T-F-300S	2917502	1
ETD-BL-1T-F- 30MIN	2917515	1
ETD-BL-1T-F-300MIN	2917528	1
ETD-BL-1T-F- 10S-PT	2901489	1
ETD-BL-1T-F-300S-PT	2901490	1
ETD-BL-1T-F- 30MIN-PT	2901491	1
ETD-BL-1T-F-300MIN-PT	2901492	1

Monitoring

Monitoring relays, timer relays, special function modules

Multifunctional timer relays

The full range of conventional applications can be accommodated by the three versions of the **ETD** multifunctional timer relay.

- Suitable for universal use thanks to varied functions and selectable time ranges
- Time ranges from a few milliseconds to several days
- Variable supply voltage range
- 2 floating PDT outputs

Notes:
1) EMC: Class A product, see page 571



**Multifunctional timer relay,
two adjustable times**



Housing width 22.5 mm

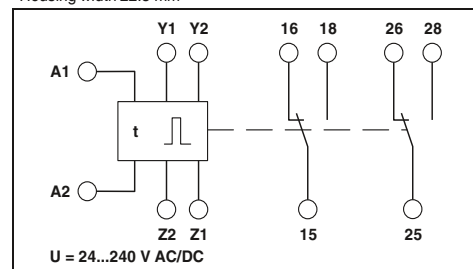

Technical data

Ip: Switched-mode beginning with the pause
Ii: Switched-mode beginning with the pulse
ER: With switch-on and release delay with control contact
EWu: With switch-on delay and single shot leading edge, voltage controlled
EWS: With switch-on delay and single shot leading edge with control contact
WsWa: With single shot leading edge and single shot trailing edge with control contact
Wt: Pulse sequence evaluation (retriggerable release delay)

Functions

Time ranges
Setting range
Control contact
Connection
Load capacity
Cable length
Control pulse length
Relay output
Contact type
Switching capacity

50 ms ... 10 h (10 time end ranges)
Floating, basic isolation between connection and input/output/bridge Y1-Y2
Cannot carry load
max. 10 m
min. 50 ms (Only with Wt function: > 7 ms)
2 floating PDT contacts
750 VA (3 A/250 V AC, module aligned, ≤ 5 mm spacing)
1250 VA (5 A/250 V AC, module not aligned, ≥ 5 mm spacing)

Mechanical service life
General data
Supply voltage
Nominal power consumption
Degree of protection
Ambient temperature range
Housing material
Dimensions W / H / D
Screw connection solid / stranded / AWG
Conformance / approvals
Conformance
UL, USA / Canada

Approx. 2×10^7 cycles
24 V DC ... 240 V DC -20 % ... +25 %
24 V AC ... 240 V AC -15 % ... +10 %
2.5 VA (1 W)
IP40 (housing) / IP20 (connection terminal blocks)
-25°C ... 55°C
Polyamide PA, self-extinguishing
22.5 / 90 / 113 mm
0.5 ... 2.5 mm² / 0.5 ... 2.5 mm² / 20 - 14
CE-compliant
UL/C-UL listed UL 508

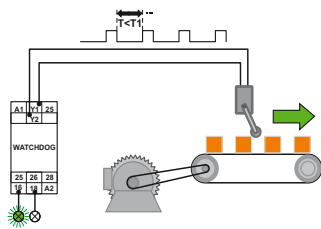

Function: Pulse sequence evaluation

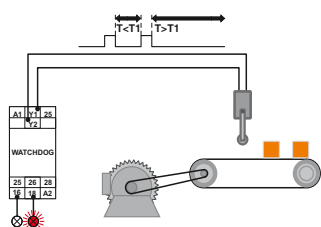

Message for incorrect pulse

Description
Electronic timer relay with adjustable functions and times

Ordering data

Type	Order No.	Pcs. / Pkt.
ETD-FL-2T-DT1 ¹⁾	2866187	1



Multifunctional timer relay,
one adjustable time



Impulse encoder,
adjustable pulse and pause times

Housing width 22.5 mm

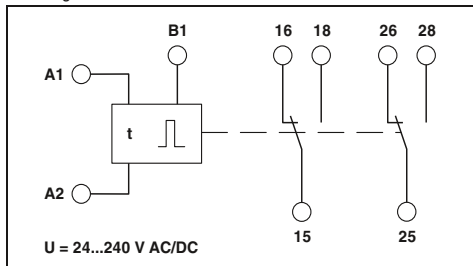

Housing width 22.5 mm

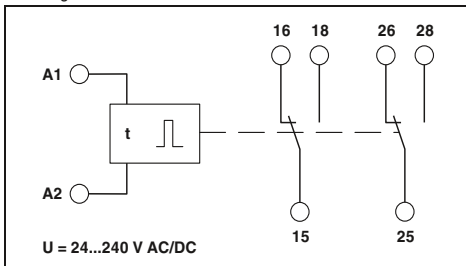

Technical data

- E: With switch-on delay
- R: With release delay and control contact
- Es: With switch-on delay and control contact
- Wu: With single shot leading edge, voltage controlled
- Ws: With single shot leading edge and control contact
- Wa: With single shot trailing edge and control contact
- Bi: Flashing beginning with pulse
- Bp: Flashing beginning with pause

Technical data

- Ip: Switched-mode beginning with the pause
- Ii: Switched-mode beginning with the pulse

50 ms ... 100 h (7 time end ranges)

Non-floating, terminals A1-B1

Parallel switched minimum load current 1 VA (0.5 W), terminals A2-B1

max. 10 m
min. 70 ms

2 floating PDT contacts
750 VA (3 A/250 V AC, module aligned, ≤ 5 mm spacing)
1250 VA (5 A/250 V AC, module not aligned, ≥ 5 mm spacing)

Approx. 2 x 10⁷ cycles

24 V DC ... 240 V DC -20 % ... +25 %
24 V AC ... 240 V AC -15 % ... +10 %
2.5 VA (1 W)
IP40 (housing) / IP20 (connection terminal blocks)
-25°C ... 55°C
Polyamide PA, self-extinguishing
22.5 / 90 / 113 mm
0.5 ... 2.5 mm² / 0.5 ... 2.5 mm² / 20 - 14

CE-compliant
UL/C-UL listed UL 508

50 ms ... 100 h (7 time end ranges)

-

-

-
-

2 floating PDT contacts
750 VA (3 A/250 V AC, module aligned, ≤ 5 mm spacing)
1250 VA (5 A/250 V AC, module not aligned, ≥ 5 mm spacing)

Approx. 2 x 10⁷ cycles

24 V DC ... 240 V DC -20 % ... +25 %
24 V AC ... 240 V AC -15 % ... +10 %
2.5 VA (1 W)
IP40 (housing) / IP20 (connection terminal blocks)
-25°C ... 55°C
Polyamide PA, self-extinguishing
22.5 / 90 / 113 mm
0.5 ... 2.5 mm² / 0.5 ... 2.5 mm² / 20 - 14

CE-compliant
UL/C-UL listed UL 508

Ordering data

Type	Order No.	Pcs. / Pkt.
ETD-SL-1T-DTF ¹⁾	2866161	1

Ordering data

Type	Order No.	Pcs. / Pkt.
ETD-SL-2T-I ¹⁾	2866174	1

Monitoring

Monitoring relays, timer relays, special function modules

Diode modules

Diode circuits perform various tasks in electrical control systems, particularly in electronic ones:

- Electrical decoupling of messages in fault signaling systems
- Spark-suppression diodes for limiting surge voltages of inductive loads, (solenoid valves, DC relays or similar)
- Can be supplied as “diode gates” combined with anode or cathode or as freely assignable diodes



with diode type 1 N 4007



with diode type 1 N 5408

Notes:
Further circuit diagrams can be found in the data sheet at www.phoenixcontact.net/products

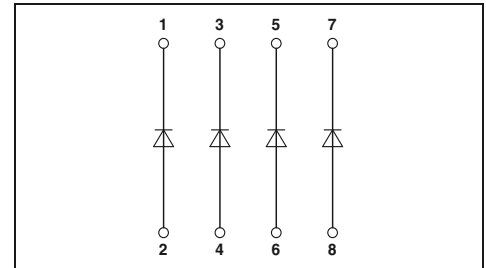
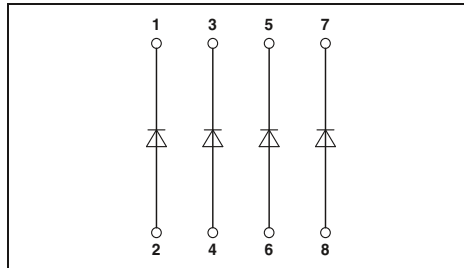

Diodes	
Max. operating voltage U_{max}	250 V AC
Peak reverse voltage per diode	1300 V
Reverse current per diode	5 μ A
Conducting state voltage per diode	Approx. 0.8 V
Conducting state current per diode	
	with single load
	with simultaneous loads
General data	
Ambient temperature range	-20°C ... 50°C
Rated insulation voltage	300 V (According to EN 50178)
Pollution degree / Surge voltage category	III, basic insulation (as per EN 50178)
Pollution degree / Surge voltage category	2 (according to EN 50178)
Mounting position	Any
Mounting	In rows with zero spacing
Dimensions H / D	75 / 55 mm
Screw connection solid / stranded / AWG	0.2 ... 4 mm ² / 0.2 ... 2.5 mm ² / 24 - 12
Conformance / approvals	
Conformance	CE-compliant

Technical data	
4E / 8E / 17E / 7P / 7M	14P / 14M / 32P / 32M
250 V AC	250 V AC
1300 V	1300 V
5 μ A	5 μ A
Approx. 0.8 V	Approx. 0.8 V
	with single load
	with simultaneous loads
General data	
Ambient temperature range	-20°C ... 50°C
Rated insulation voltage	300 V (According to EN 50178)
Pollution degree / Surge voltage category	III, basic insulation (as per EN 50178)
Pollution degree / Surge voltage category	2 (according to EN 50178)
Mounting position	Any
Mounting	In rows with zero spacing
Dimensions H / D	75 / 55 mm
Screw connection solid / stranded / AWG	0.2 ... 4 mm ² / 0.2 ... 2.5 mm ² / 24 - 12
Conformance / approvals	
Conformance	CE-compliant

Technical data	
4E-... / 4P-... / 4M-... / 8E-...	8P-... / 8M-...
250 V AC	250 V AC
1000 V	1000 V
10 μ A	10 μ A
Approx. 0.8 V	Approx. 0.8 V
	with single load
	with simultaneous loads
General data	
Ambient temperature range	-20°C ... 50°C
Rated insulation voltage	300 V (According to EN 50178)
Pollution degree / Surge voltage category	III, basic insulation (as per EN 50178)
Pollution degree / Surge voltage category	2 (according to EN 50178)
Mounting position	Any
Mounting	In rows with zero spacing
Dimensions H / D	75 / 55 mm
Screw connection solid / stranded / AWG	0.2 ... 4 mm ² / 0.2 ... 2.5 mm ² / 24 - 12
Conformance / approvals	
Conformance	CE-compliant

Description	Housing width
Diode module, can be individually wired	
4 diodes	22.5 mm
8 diodes	45 mm
17 diodes	90 mm
Diode module, with P-polarity (common cathode)	
4 diodes	22.5 mm
7 diodes	22.5 mm
8 diodes	45 mm
14 diodes	45 mm
32 diodes	90 mm
Diode module, with M polarity (common anode)	
4 diodes	22.5 mm
7 diodes	22.5 mm
8 diodes	45 mm
14 diodes	45 mm
32 diodes	90 mm

Ordering data		
Type	Order No.	Pcs. / Pkt.
EMG 22-DIO 4E	2950048	10
EMG 45-DIO 8E	2950103	5
EMG 90-DIO 17E	2954895	5
EMG 22-DIO 7P	2950064	10
EMG 45-DIO14P	2950116	5
EMG 90-DIO 32P	2954918	5
EMG 22-DIO 7M	2950077	10
EMG 45-DIO14M	2950129	5
EMG 90-DIO 32M	2954934	5

Ordering data		
Type	Order No.	Pcs. / Pkt.
EMG 22-DIO 4E-1N5408	2952790	10
EMG 45-DIO 8E-1N5408	2949389	5
EMG 22-DIO 4P-1N5408	2952198	10
EMG 45-DIO 8P-1N5408	2954879	5
EMG 22-DIO 4M-1N5408	2952211	10
EMG 45-DIO 8M-1N5408	2954882	5

Accessories	
Equipment marker	EMG-GKS 12

Accessories	
EMG-GKS 12	2947035

Accessories	
EMG-GKS 12	2947035

Lamp testing modules, display modules

Lamp testing modules

Lamp testing modules for checking lamps that are installed and ready for operation:

- Individual checking of separate lamps (EMG...-E/LP)
- Centrally controlled checking of lamps (EMG...-M/LP)

Display modules

- Light indicator modules facilitate the monitoring of processes on electronic control systems during troubleshooting



Lamp testing module, groups of 2 diodes with common cathode



Light indicator module, with common return line

Notes:
Further circuit diagrams can be found in the data sheet at www.phoenixcontact.net/products

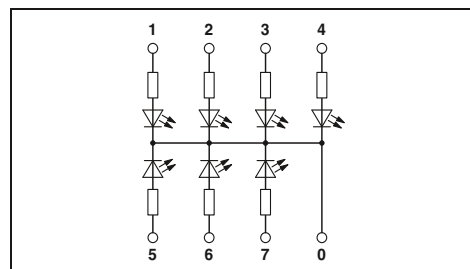
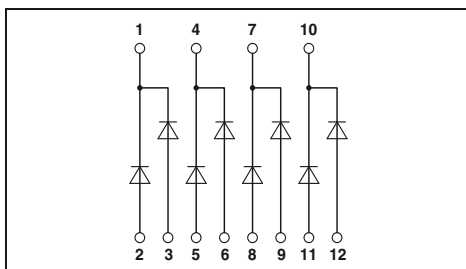

Diodes	
Max. operating voltage U_{max}	250 V AC
Peak reverse voltage per diode	1300 V
Reverse current per diode	$\leq 5 \mu A$
Conducting state voltage per diode	Approx. 0.8 V
Conducting state current per diode	with single load: 0.7 A with simultaneous loads: 0.4 A
Input	
Current required per light indicator	Approx. 1 mA
General data	
Ambient temperature range	-20°C ... 50°C
Rated insulation voltage	300 V (According to EN 50178)
Pollution degree / Surge voltage category	III, basic insulation (as per EN 50178)
Pollution degree / Surge voltage category	2 (according to EN 50178)
Mounting position	Any
Mounting	In rows with zero spacing
Dimensions H / D	75 / 55 mm
Screw connection solid / stranded / AWG	0.2 ... 4 mm ² / 0.2 ... 2.5 mm ² / 24 - 12
Conformance / approvals	CE-compliant
Conformance	CE-compliant

Technical data

8E/16E	14M/32M
250 V AC	250 V AC
1300 V	1300 V
$\leq 5 \mu A$	$\leq 5 \mu A$
Approx. 0.8 V	Approx. 0.8 V
with single load: 0.7 A	0.7 A
with simultaneous loads: 0.4 A	0.2 A
Input	
Current required per light indicator	Approx. 1 mA
General data	
Ambient temperature range	-20°C ... 45°C
Rated insulation voltage	300 V (According to EN 50178)
Pollution degree / Surge voltage category	III, basic insulation (as per EN 50178)
Pollution degree / Surge voltage category	2 (according to EN 50178)
Mounting position	Any
Mounting	In rows with zero spacing
Dimensions H / D	75 / 47.5 mm
Screw connection solid / stranded / AWG	0.2 ... 4 mm ² / 0.2 ... 2.5 mm ² / 24 - 12
Conformance / approvals	CE-compliant
Conformance	CE-compliant

Technical data

LA 7S	LED 7S/LED 14S
Input	
Current required per light indicator	Approx. 3 mA
General data	
Ambient temperature range	-20°C ... 45°C
Rated insulation voltage	300 V (According to EN 50178)
Pollution degree / Surge voltage category	III, basic insulation (as per EN 50178)
Pollution degree / Surge voltage category	2 (according to EN 50178)
Mounting position	Any
Mounting	In rows with zero spacing
Dimensions H / D	75 / 47.5 mm
Screw connection solid / stranded / AWG	0.2 ... 4 mm ² / 0.2 ... 2.5 mm ² / 24 - 12
Conformance / approvals	CE-compliant
Conformance	CE-compliant

Description	Housing width
Lamp testing module, for individual wiring	
4-pair	45 mm
8-pair	90 mm
Lamp testing module, with common control	
7-pair	45 mm
16-pair	90 mm
Light indicator module, 110 ... 230 V AC input voltage	
7 glow lamps	22.5 mm
Light indicator module, 24 V DC input voltage	
7 LEDs	22.5 mm
14 LEDs	45 mm

Ordering data

Type	Order No.	Pcs. / Pkt.
EMG 45-DIO 8E/LP	2954798	5
EMG 90-DIO 16E/LP	2954808	5
EMG 45-DIO14M/LP	2950132	5
EMG 90-DIO 32M/LP	2954785	5

Ordering data

Type	Order No.	Pcs. / Pkt.
EMG 22-LA 7S/230	2949677	10
EMG 22-LED 7S/24	2952305	10
EMG 45-LED 14S/24	2952334	5

Equipment marker

Accessories

EMG-GKS 12	2947035	50
------------	---------	----

Accessories

EMG-GKS 12	2947035	50
------------	---------	----



Relay modules

The importance of the reliability of industrial automation equipment is growing with the increase in use of electronic modules.

Modern relay or solid-state relay interfaces perform a wide range of tasks. Whether in production engineering, for the electrical equipment of machines or in control engineering for energy distribution, building automation and materials processing – the main aim is to guarantee the exchange of signals between the process peripherals and the superior, central control systems. This exchange must provide reliable operation, be floating and electrically unambiguous.

Safe electrical interface modules that meet the requirements of modern system concepts must include the following features:

- Coupling of different signal levels
- Safe electrical isolation between input and output
- High interference insensitivity.

In practice, a relay interface comes into use with a flexible interface configuration with a large switching capacity range and the possibility of combining different types of contact. Further important features of relay interfaces are:

- Electrical isolation between open contacts
- Switching of independent switching current types
- High short-term overload resistance in the event of a short circuit or voltage peaks
- Practically impervious to electromagnetic fields
- Easy handling.

Solid-state relay modules are used when an interface between the process peripherals and electronics is subject to the following requirements:

- Low control power
- High switching frequencies
- Wear-free switching with no contact bounce
- Resistance to vibration and impacts
- Long service life.

Product range overview

Product overview	266
Basics of relay technology	268
Basics of solid-state relay technology	272
RIFLINE complete	274
PLC series	320
PR series	370
DEK series	396
Special relay and solid-state relay modules	402

Relay modules

Product overview

RIFLINE complete



RIF-0 for miniature and solid-state relays
Page 276



RIF-1 for miniature and solid-state relays
Page 282



RIF-2 for industrial relays
Page 290



RIF-3 for octal relays
Page 294

PLC series



With relay/solid-state relay
As sensor/actuator version
Page 322
Page 326



For high inrush/continuous currents
Resistant to interference currents/voltages
Page 332
Page 334



With switch
For railway applications
Page 350
Page 359

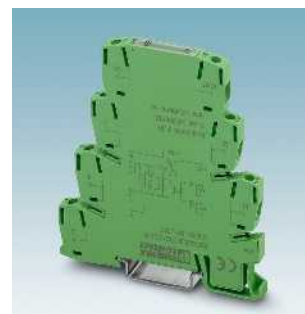

For NAMUR initiators
Types of electronics
Page 364
Page 365

DEK series

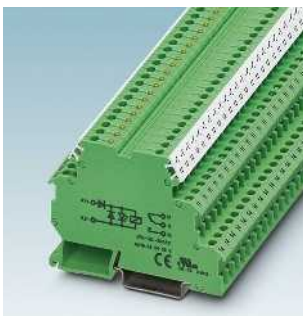

With miniature relay
Page 397

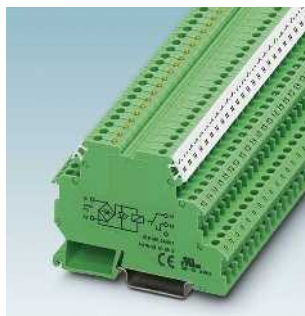

Actuator series with miniature relays
Page 399

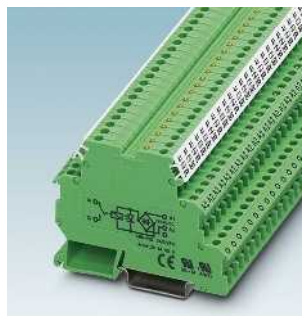

Sensor series with miniature relays
Page 399

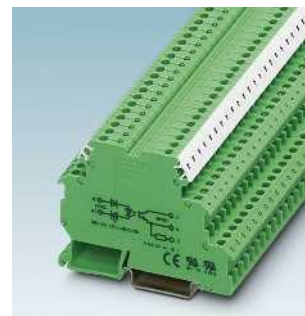

With solid-state relay
Page 400

Safety devices



Safety devices
See Catalog 8

Monitoring relays



Monitoring relays
Page 250

Timer relays



Timer relays
Page 258



RIF-4 for high-power relays
Page 298



Accessories
Page 304

PR series



PR1 for miniature or solid-state relays
Page 372



PR2 for industrial relays
Page 378



PR3 for octal relays
Page 382



Accessories
Page 373

Special relay and solid-state relay modules

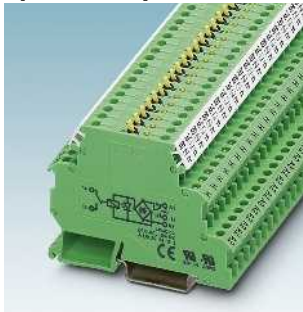

Relay terminal blocks with switch
Page 403



Interference-free relays and solid-state relays
Page 404



Relays for switching lamp loads
Page 407



Solid-state power relays with 400 V AC/400 V AC/3 A output
Page 408

Basics of relay technology

General

Electromechanical relays are used as interface modules between the process I/O devices, on the one hand, and the open-loop/closed-loop control and signaling equipment, on the other, for level and power adjustment purposes.

Essentially, electromechanical relays can be divided into two main groups: monostable and bistable relays.

With monostable DC or AC relays, the contacts automatically return to the release state as soon as they are de-energized.

In the case of bistable relays, the contacts remain in their present switch position when the excitation current is switched off.

Coil side

Input circuits and voltage types

There are various kinds of input circuit depending on the type of relay used and the nature of the control voltage.

If pure AC relays are used (AC input), the input circuit is generally nothing more than a visual switching status indicator.

Unless otherwise specified, the frequency of the control voltage is 50/60 Hz.

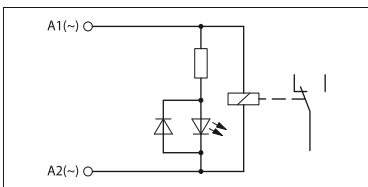

Basic construction of a relay with AC input

In the case of a pure DC input, the most important addition to the circuit is a freewheeling diode. This limits the voltages induced on the coil on circuit interruption to a value of approximately 0.7 V, which does not pose a danger to any connected control electronics.

As the freewheeling diode can only perform its required function if the polarity of the voltage connection is correct, a reverse polarity protection diode is also integrated into the input circuit.

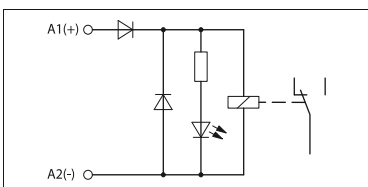

Basic construction of a relay with DC input

To allow DC or AC voltage operation, a bridge rectifier is connected in the input circuit. The diodes are simultaneously responsible for performing rectification, freewheeling, and polarity reversal protection functions. The interrupting voltage of the coil is limited to approximately 1.4 V.

To protect the input circuit against over-voltages, a varistor is also connected (depending on the type) upstream of the bridge rectifier.

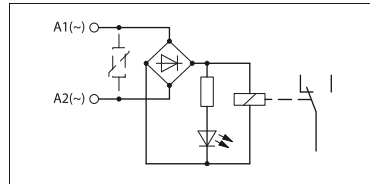

Basic construction of a relay with AC/DC input

Bistable remanence relays with a double winding are only ever operated with DC voltage.

With these types of relay, there are three coil connections on the coil side. In addition to the common connection, there are separate connections for “setting” and “resetting”; these are controlled by short pulses only. As a result, the relays hardly heat up at all. Simultaneous control of both control inputs is not permitted.

A distinction is made between negative switching (M) and positive switching (P) types, depending on the polarity of the freewheeling and reverse polarity protection diodes.

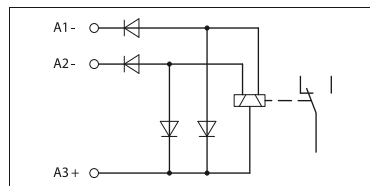

Block diagram of a bistable relay, negative switching type

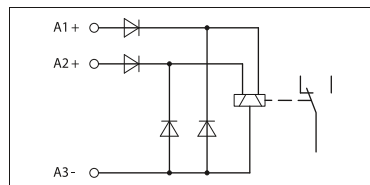

Block diagram of bistable relay, positive switching type

Operating voltage range

The ambient temperature prevailing at the location of use has a major impact on certain relay operating parameters.

As the ambient temperature increases, the coil winding heats up, causing the operate and release voltages to rise. At the same time, the maximum permissible coil voltage decreases, which means that the usable

working range becomes restricted as a result.

The diagram below illustrates how the operating voltage behaves as a function of the ambient temperature.

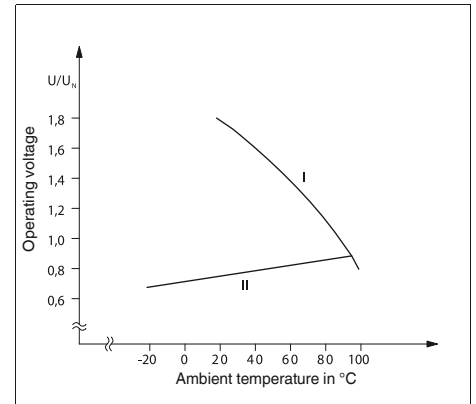

Basic curve of a relay operating voltage

- I: Maximum permissible voltage with 100% operating time (OT) and assuming compliance with the coil temperature limit
- II: Minimum operate voltage

Interference voltages and interference currents on the coil side

When inductive or capacitive interference voltages are coupled into the long supply lines of a relay, this can prevent the relay from operating safely.

If the coupled-in voltage exceeds the release voltage required by the IEC 61810-1 “relay standard”, in extreme cases the relay may fail to release. In the case of DC relays, this release voltage is $\geq 0.05 \times U_N$ and for purely AC relays, it is $\geq 0.15 \times U_N$.

The same disturbances can occur when a relay with a low input power is controlled by an electronics module with an AC voltage output featuring an RC circuit. The typical leakage current from RC elements of this kind (generally in the region of several mA) provides sufficient control power to prevent the downstream relay from releasing or even enough power to excite it.

The disturbance level of any interference voltages that are present can be reduced by connecting an RC element parallel to the relay coil. This measure also subjects the interference voltage to a capacitive load, causing it to collapse.

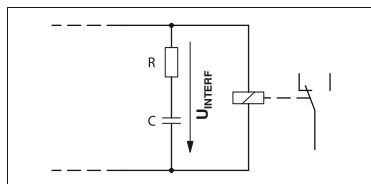

External RC interference suppression filter to prevent interference voltage coupling

The following values are recommended for the purpose of dimensioning the RC element:

- R = 100 ... 220 Ω
- C = 220 ... 470 nF

The SO46 series have been developed to provide even higher levels of immunity to interference. These products already contain an integrated RCZ filter. See, for example, PLC...SO46.

Contact side, contact materials

Given the wide variety of potential applications in the different industrial sectors, the relays used must be matched to the various tasks that need to be performed by selecting the right kind of contact material.

The voltage, current, and power values play an important role when determining the suitability of contact materials. Other criteria include:

- Contact resistance
- Erosion resistance
- Material migration
- Welding tendency
- Chemical influences

In this way, the various contact materials (generally noble metal alloys) can be matched to the relevant areas of application.

The adjacent table provides details of some of the key materials.

Contact material	Typ. properties	Typ. applications	Guide values for the area of application*
Gold Au	Largely insensitive to industrial atmospheres; low and constant contact resistances in the range of small switching capacities with nickel (AuNi) or silver (AuAg) alloys	Dry measuring and switching circuits, control inputs	μA ... 0.2 A μV ... 30 V
Silver Ag	High electrical conductivity; sensitive to sulfur, therefore often gold-flashed (approximately 0.2 μm) as protection; nickel (AgNi) or copper (AgCu) alloys increase the mechanical resistance and erosion resistance and reduce the welding tendency.	Universal; suitable for medium loads; nickel alloys (AgNi 0.15) for DC circuits with medium to large loads.	≥ 12 V ≥ 10 mA
Silver, hard gold-plated Ag+Au	Properties similar to gold Au. When switching loads > 30 V/0.2 A, the hard gold plating (5 - 10 μm) is destroyed and the values and properties of the Ag contact are applicable. However, a reduction in the service life is then to be expected.	Suitable for control inputs and other small loads.	≥ 100 mV ≥ 1 mA
Tungsten W	Highest melting point; very high erosion resistance; greater contact resistances; very low welding tendency; susceptible to corrosion; often used as lead contact.	Loads with very high inrush currents, e.g., glow lamps, fluorescent lamps.	≥ 60 V ≥ 1 A
Silver nickel AgNi	High erosion resistance; low welding tendency; higher contact resistances than with pure silver.	Universal; suitable for medium to high loads; DC circuits and inductive loads.	≥ 12 V ≥ 10 mA
Silver nickel AgNi+Au	Properties similar to gold Au. When switching loads > 30 V/0.2 A, the hard gold plating (5 - 10 μm) is destroyed and the values and properties of the AgNi contact are applicable. However, a reduction in the service life is then to be expected.	Suitable for control inputs and other small loads.	≥ 100 mV ≥ 1 mA
Silver tin oxide AgSnO	Low welding tendency; very high erosion resistance for high switching capacities; low material migration	Application depends heavily on the relay type; switching circuits with high make and break loads, e.g., glow lamps and fluorescent lamps, AC and DC circuits. Due to different alloys and production procedures, partly also suitable for smaller loads.	≥ 12 V ≥ 100 mA (≥ 10 mA)
Silver tin oxide, hard gold-plated AgSnO+Au	Properties similar to gold Au. When switching loads > 30 V/0.2 A, the hard gold plating (5 - 10 μm) is destroyed and the values and properties of the AgSnO contact are applicable. However, a reduction in the service life is then to be expected.	Suitable for control inputs and other small loads.	≥ 100 mV ≥ 1 mA

* Values depend on the relay used and on further operating conditions.

Contact protection circuit

Every electrical load constitutes a mixed load with ohmic, capacitive, and inductive components.

When these loads are switched, the switching contact is in turn subjected to a load, to either a lesser or greater extent. This load can be reduced by including a suitable contact protection circuit.

In view of the fact that loads with a large inductive component are predominantly used in practice (e.g., contactors, solenoid valves, motors, etc.), these application scenarios are worth considering in more detail.

On interruption, voltage peaks with values of up to several thousand volts occur due to the energy stored in the coil.

These high voltages cause an arc on the switching contact which can destroy the contact due to material vaporization and material migration. The electrical service life is reduced considerably as a result. In extreme cases, the relay may fail in the very first cycle with DC voltage and a static arc.

A protective circuit must be used to suppress the formation of an arc. With optimum dimensioning, almost the same number of cycles can be achieved as with an ohmic load.

Basics of relay technology

In principle, there are a number of possible ways of achieving an effective circuit:

1. Contact wiring
2. Load wiring
3. Combination of both wiring methods

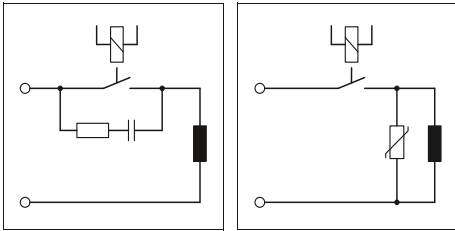

Contact wiring

Inductive load wiring

In principle, protective measures should intervene directly at the source of the interference.

Wiring a load should therefore be given priority over wiring the contact.

The following points are advantageous for the load circuit (image on right):

1. The circuit is only loaded with the induction voltage during interruption. By contrast, the sum of the operating voltage and the induction voltage is applied to the contact circuit.
2. When the contact is open, the load is electrically isolated from the operating voltage.
3. It is not possible for the load to be activated or to "stick" due to undesired operating currents, e.g., from RC elements.
4. Cut-off peaks of the load cannot be coupled into parallel control lines.

Nowadays, solenoid valves are usually connected using valve plugs that are also supplied with LEDs and components that limit the induction voltage. Valve plugs with an RC element, varistor or Zener diode often do not quench the arc and only serve to comply with legislation governing EMC. Only valve plugs with an integrated 1N4007 freewheeling diode quench the arc quickly and safely, thereby increasing the service life of the relay by a factor of 5 to 10. Valve plugs with LED, integrated 1N4007, and free cable end can be supplied on request as part of the SAC range.

Load wiring	Additional dropout delay	Defined induction voltage limitation	Effective bipolar attenuation	Advantages/disadvantages
Diode 	Large	Yes (U_D)	No	Advantages: <ul style="list-style-type: none"> • Good effect in terms of extending the service life of the contacts • Easy implementation • Inexpensive • Reliable • Dimensioning not critical • Low induction voltage Disadvantages: <ul style="list-style-type: none"> • Attenuation only via load resistor • Long dropout delay
Diode/Zener diode series connection 	Medium to small	Yes (U_{ZD})	No	Advantages: <ul style="list-style-type: none"> • Dimensioning not critical Disadvantages: <ul style="list-style-type: none"> • Attenuation only above U_{ZD} • Minimal effect in terms of extending the service life of the contacts
Suppressor diode 	Medium to small	Yes (U_{ZD})	Yes	Advantages: <ul style="list-style-type: none"> • Inexpensive • Dimensioning not critical • Limitation of positive peaks • Suitable for AC voltages Disadvantages: <ul style="list-style-type: none"> • Attenuation only above U_{ZD} • Minimal effect in terms of extending the service life of the contacts
Varistor 	Medium to small	Yes (U_{VDR})	Yes	Advantages: <ul style="list-style-type: none"> • High energy absorption • Dimensioning not critical • Suitable for AC voltages Disadvantages: <ul style="list-style-type: none"> • Attenuation only above U_{VDR} • Minimal effect in terms of extending the service life of the contacts
R/C combination 	Medium to small	No	Yes	Advantages: <ul style="list-style-type: none"> • HF attenuation due to energy storage • Suitable for AC voltages • Level-independent damping Disadvantages: <ul style="list-style-type: none"> • Precise dimensioning required • High inrush current surge • Minimal effect in terms of extending the service life of the contacts

Switching small loads

Small loads must be processed mainly in applications where signals must be forwarded to control inputs (e.g., of a PLC).

With these loads, no switching sparks (arcs) occur on the contacts in the small load range.

In addition to the constant cleaning effect due to contact friction, this switching spark assumes the function of penetrating non-conductive contamination layers that are formed on the contact surfaces of power contacts.

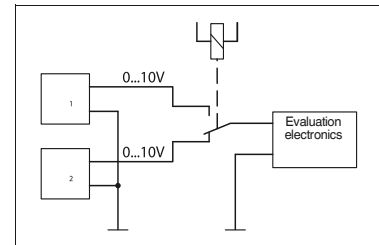

Application example: measurement point changeover

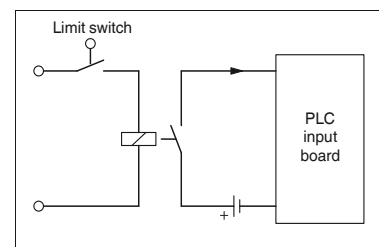

Application example: PLC input signal

These contamination layers are usually oxidation or sulfidation products of the contact materials silver (Ag) or silver alloys such as silver nickel (AgNi) or silver tin oxide (AgSnO). As a result, the contact resistance may rise so considerably within a short time that reliable switching is no longer possible in the case of small loads.

Due to these properties, the high-performance contact materials mentioned are not suitable for small load applications.

Gold (Au) has become accepted as the contact material of choice for these areas of application mainly on account of its low and constant contact resistances even with small loads and its insensitivity to sulfurous atmospheres.

For the smallest of loads and even greater contact reliability, double contact relays with gold contacts are used.

The slotted contact spring in this design provides two parallel contact points with even lower contact resistances and considerably higher contact reliability.

Switching large loads

A few important points also need to be considered with regard to switching operations in the large load range that involve power contacts made of either silver (Ag) or silver tin oxide (AgSnO).

A basic distinction must be made between switching DC and AC loads.

Switching large AC loads

When switching large AC loads, the relay can be operated up to the corresponding maximum values for switching voltage, current, and power. The arc that occurs during interruption depends on the current, voltage, and phase angle. This cut-off arc usually disappears automatically the next time the load current passes through zero.

In applications with an inductive load, an effective protective circuit must be provided, otherwise the service life of the system will be reduced considerably.

Switching large DC loads

Conventional switching relays can only switch off relatively small direct currents (which contrasts with their ability to switch off the maximum permissible AC current), since there is no zero crossing to extinguish the arc automatically. This maximum DC value is also dependent to a large extent on the switching voltage and is determined, among other things, by constructional features such as contact spacing and contact opening speed.

The corresponding current and voltage values are documented by relay manufacturers in arc or load limit curves.

A non-attenuated inductive DC load fur-

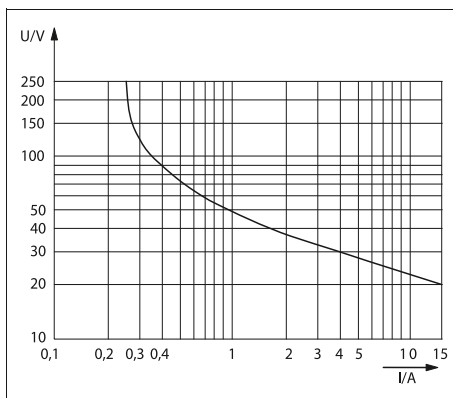

Example of a load limit curve (dependent on the type)

ther reduces the values given for switchable currents. The energy stored in the inductance can cause an arc to occur, which forwards the current through the open contacts.

With an effective contact protection circuit, preferably type 1N4007 freewheeling diodes, the service life can be increased by a factor of 5 to 10 compared with unprotected or poorly protected inductive loads (see also "Contact protection circuits" section).

If higher DC loads than those documented are to be switched or if the electrical service life is to be increased, several contacts of a relay can be connected in series. See, for example, REL-IR... industrial relays.

Alternatively, solid-state relays with DC voltage output can also be used.

Switching lamps and capacitive loads

Regardless of the type of voltage, all kinds of lamps and loads with a capacitive component impose extreme requirements on the switching contacts. The moment it is switched on, in other words precisely in the dynamic chattering phase of the relay, extremely powerful current peaks occur.

These are often in the region of several tens of amps, and not infrequently are known to exceed 100 A, which results in welding of the contact. This can be remedied by using specially optimized "lamp load relays" that can cope with these inrush peaks. See, for example, PLC...IC type.

Switching capacity in accordance with utilization categories AC15 and DC13 (IEC 60947)

In practice, both the maximum interrupting rating for AC loads and the DC interruption values taken from the load limit curves provide only a rough guide for the choice of relay. In reality, this is insufficient, since real loads in the vast majority of industrial applications have inductive or capacitive components and the wiring of the loads can be totally different. As already described, this sometimes leads to considerable variations in terms of service life.

The IEC 60947 contactor standard seeks to avoid these disadvantages by dividing the loads into various utilization categories (DC13, AC15, etc.). This standard is also partly applied to relays. However, users must be aware of the fact that these values are only applicable in practice to a limited extent as well, since all DC13 and AC15 test loads are highly inductive and are also operated without any protective circuit at all (see "Contact protection circuit" section). Moreover, the switching capacity test in accordance with IEC 60947 only requires 6060 cycles to be performed by way of a minimum requirement.

A much more reliable way to determine the switching capacity and the anticipated service life is to refer to the specific application data. Using a comprehensive data bank, the service life can be accurately estimated for most applications and, if necessary, suggestions for improvement can be made. In the case of critical applications, the user is advised to gather service life information based on empirical data.

Basics of solid-state relay technology

Control side

Solid-state relays for various voltage and power levels are available from Phoenix Contact for use as interface modules designed to match process I/O devices to control, signaling, and regulating devices. The solid-state relay element which is actually located in the module is limited to one defined voltage range by virtue of its design. The current consumption on the input side fluctuates depending on the circuit architecture and voltage level.

To accommodate all industrial voltages between 5 V and 230 V, an input circuit is provided. The inputs for DC voltage and AC voltage must always be differentiated.

DC input

Adjustments are made in accordance with the various voltage levels by adding electronics which have been specially adapted to the desired voltage range. In the case of most modules, a polarity protection diode provides reliable protection against destruction in the event of a control voltage being connected incorrectly. Specially coordinated filters reliably suppress possible high-frequency noise emissions.

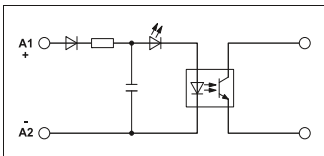

Figure 1: block diagram for DC input

AC input

The solid-state relay element requires a stable control voltage to ensure reliable operation. In the case of the AC input, this is achieved by connecting a rectifier and filter capacitor upstream. Rectifying is followed, in principle, by the same circuit architecture as the DC input.

The switching frequency always lies below half the mains frequency. Due to the filter capacitor, a higher switching frequency cannot be achieved. This would result in continuous through-switching.

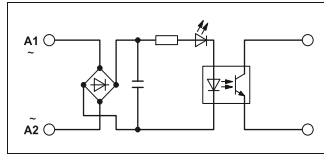

Figure 2: block diagram for AC input

Load side

Depending on the application and the type of load, the solid-state relay output must meet various requirements. The following are crucial:

- Power amplification
- Matching the switching voltage and the switching current (AC/DC)
- Short-circuit protection

For these different applications, the solid-state relay element must also be processed using additional electronics on the output side.

DC output

In order to achieve the necessary output power, the solid-state relay element is supplemented by one or more semiconductor components.

The on-site user should nevertheless simply regard the connection terminal blocks of the output as conventional switch connections. Observing the specified polarity is the only essential requirement.

For practical reasons, the following criteria should be taken into account when selecting a suitable solid-state relay:

1. Operating voltage range (e.g., 12 ... 60 V DC)

This determines the minimum or maximum voltage to be switched. The lower value must be observed in order to ensure reliable operation. In order to protect the output transistor, the upper value must not be exceeded.
2. Maximum continuous current (e.g., 1 A)

This value indicates the maximum continuous current. If this value is exceeded continuously, the output semiconductor will be destroyed. The dependence of the output current on the ambient temperature of the solid-state relay should also be taken into consideration. A de-rating curve is therefore generally specified for solid-state power relays. This

shows the maximum load current as a function of the ambient temperature.

3. Output circuit

The 2-conductor output is similar to a mechanical contact. Only the polarity of the connections is specified and must be observed.

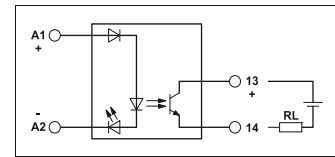

Figure 3: 2-conductor output

The 3-conductor output is non-isolated and requires both potentials from the voltage source on the output side to be connected if it is to operate reliably.

When switched off, a permanent reference to ground (negative potential) is established. In addition, this output circuit offers the advantage of an almost constant internal resistance.

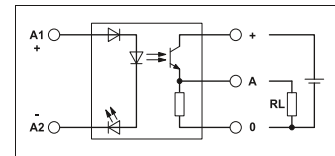

Figure 4: 3-conductor output

AC output

In order to control the switching and control devices for AC voltage, a semiconductor for AC voltage (TRIAC or thyristor) is connected downstream of the solid-state relay element.

As with the DC output, it is particularly important to consider the maximum operating voltage range and the maximum continuous load current as a function of the ambient temperature.

Basics of solid-state relay technology

In addition, the maximum peak reverse voltage of the TRIAC (e.g., 600 V) is crucial with AC outputs. This must not be exceeded even in the case of voltage fluctuations or interference voltage peaks in order to prevent destruction. That is why the AC outputs of all solid-state relays from Phoenix Contact have an internal RC protective circuit to protect against interference voltage peaks.

Application notes

Input solid-state relays acting in the direction from the I/O devices to the controller (signaling, controlling, monitoring)

Plug-in version:

- PLC-O...

Modular version:

- DEK-OE...
- EMG 10-OE...
- SIM-EI...
- OPT...

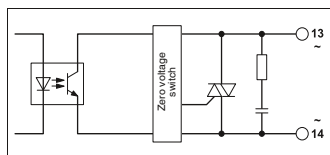

Figure 5: basic circuit diagram of AC output

Protective circuits

The moment inductive loads (contactors, solenoid valves, motors) are switched off, surge voltages occur and these can reach very high amplitudes. Electronic components and switching elements are particularly susceptible to these. A protective circuit should therefore always be provided to prevent destruction.

A parallel connection to the load effectively reduces the switching surge voltage to a harmless level. Depending on the solid-state relay output and type of load:

- A freewheeling diode/suppressor diode (DC only)
 - A varistor (AC and DC)
 - Or an RC element (AC only)
- can provide the necessary protection.

Output (power) solid-state relays acting in the direction from the controller to the I/O devices (switching, amplifying, controlling)

Plug-in version:

- PLC-O...

Modular version:

- DEK-OV...
- EMG 10-OV
- EMG 12-OV
- EMG 17-OV
- OV...
- OPT...

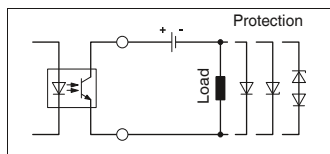

Figure 6: protective circuit with DC voltage output

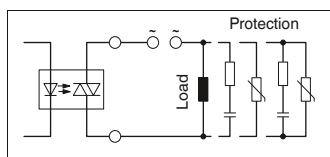
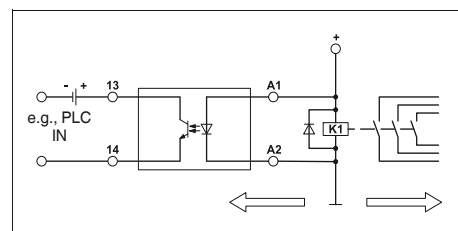
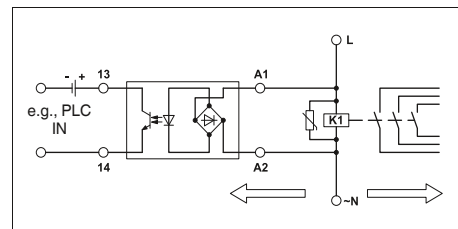

Figure 7: protective circuit with AC voltage output

Example: load contactor monitoring (DC contactor)



Example: load contactor monitoring (AC contactor)



Example: position indication with limit stop contact or initiator

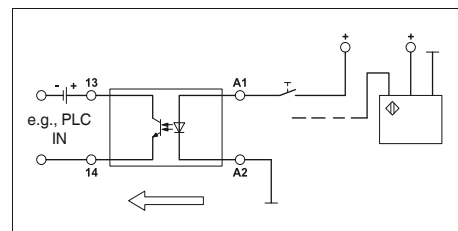

Example: switching the contactor, solenoid valve or motor (DC load)

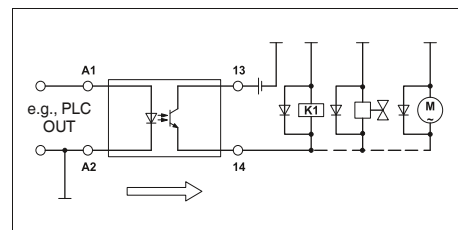

Example: switching the contactor, solenoid valve or motor (AC load)

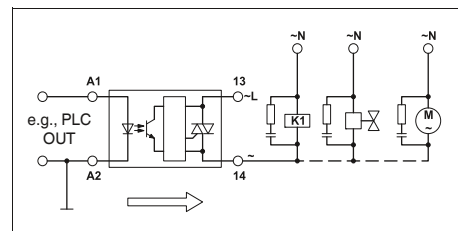

Remarks:

- 1) Ground (negative) potential from the input and output of the solid-state relay must not be connected.
- 2) DC loads must be provided with an effective protective circuit (e.g., diode).
- 3) AC loads must be protected with a varistor or an RC element.

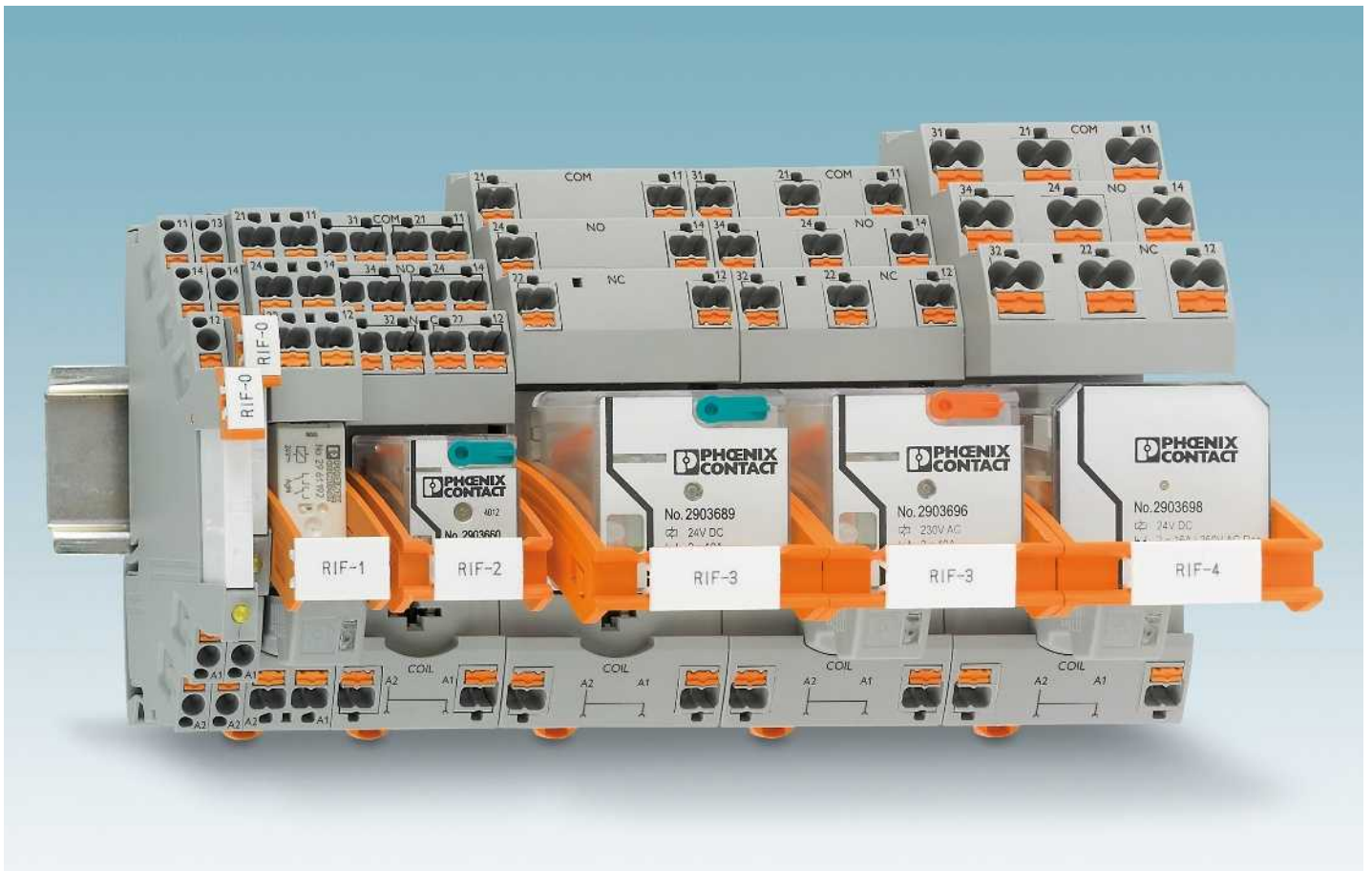

RIFLINE complete is an inexpensive relay system with various accessories. It consists of DIN rail bases, electromechanical or solid-state relays, plug-in input/interference suppression modules, marking material, and bridging material. The range of accessories is rounded off with a timer module. This can be used to transform a basic relay into a timer relay with three different functions.

The RIFLINE complete relay range consists of seven different base versions from RIF-0 to RIF-4 – these range from one N/O contact up to four PDT contacts. The field of application of this product group ranges from coupling relay applications with switching currents of one milliamp to replacement for miniature contactors with currents up to 16 A.

The relay bases feature push-in connection technology, which enables quick and tool-free conductor contacting. The RIF-1 to RIF-4 bases offer double the contact options on both the input and output side.

On the input side of all bases, the negative potential (A2) can be bridged – regardless of the base size. On the output side, the grouped contact (11) can be bridged within the RIF-0 base version. This connection can also be bridged within the RIF-1 base size.

To offer diverse marking options, the engagement lever can be fitted with a zack marker strip. In addition, marker carriers

can be mounted on the bases so that additional marking surfaces are available.

RIFLINE complete can be extended using many elements from the CLIPLINE complete accessories range. This includes marking complete material, bridges, and test adapters.

To make ordering and management easy, RIFLINE complete modules are provided in the most popular voltages as complete modules with relay and input/interference suppression module. For individual assembly, tailored to the requirements of the application, additional voltage levels are offered in the modular system.

**RIF-0**

The narrow 6.2 mm RIF-0 base series is designed for miniature relays with one contact. Switching currents up to 6 A are implemented here. Two base versions are available: 1 N/O contact and 1 PDT contact. RIF-0 is therefore a good choice for all coupling applications.

**RIF-1**

The narrow 16 mm RIF-1 base series is designed for miniature relays with 2 contacts. Currents up to 13 A can be switched when using the FBS 2-8 plug-in bridge. This is the ideal relay for applications that require coupling, power switching, and signal duplication.

**RIF-2**

The 31 mm wide RIF-2 base series is designed for industrial relays with up to 4 contacts. Currents up to 12 A are no problem for these bases. This relay is ideal for applications that require power and signal multiplication.

**RIF-3**

The 40 mm wide RIF-3 base series is designed for octal relays with up to 3 contacts. Switching currents up to 10 A can be implemented here. Two base versions are available: 2 PDT contacts and 3 PDT contacts. RIF-3 bases are ideal for all applications that require power and signal multiplication.

**RIF-4**

The 43 mm wide RIF-4 base series is designed for power relays with up to 3 contacts. Currents up to 16 A can be switched. RIF-4 bases are a good choice for applications that require power and signal multiplication, e.g., in miniature contactor applications.

**Accessories**

A wide range of accessories are available for the RIFLINE complete relay system that round off the range. These include bridges, professional marking material, special function modules, test plugs, and end brackets.

Relay modules

RIFLINE complete

Modular RIF-0 relay base

Relay base that can be fitted with miniature power relays or solid-state relays with a nominal voltage of 12 to 24 V DC.

The advantages:

- Integrated freewheeling diode for input circuit and interference suppression circuit
- LED for status display
- Safe isolation according to DIN EN 50178 between coil and contact
- Professional marking material
- Holders for test plugs
- Professional bridging of adjacent modules saves wiring time (A2 and 11/13)
- FBS 2-6 plug-in bridges for the input and output side

Notes:
Type of insulating housing: Polyamide PA non-reinforced, color: gray.
For further marking systems and mounting material, see Catalog 5.

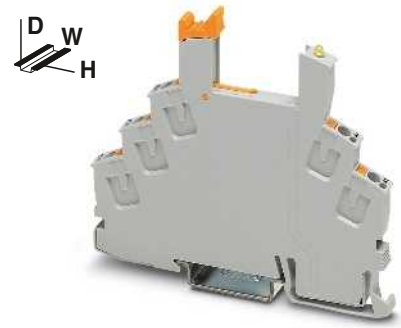

1 PDT relay base for miniature power relay

Nominal voltage U_N
Nominal current at U_N

Technical data
230 V AC (Contact side) max. 8 A (Depends on application/assembly)

General data
Ambient temperature (operation)
Connection data solid / stranded / AWG
Dimensions
Width
Depth
Height

-40°C ... 85°C (Depends on application/assembly)
0.14 ... 1.5 mm ² / 0.14 ... 1.5 mm ² / 26 - 16
6.2 mm
78 mm
93 mm

Description
RIF-0 relay base , PDT version, safe isolation I/O With push-in connection
RIF-0 relay base , N/O contact version, safe isolation I/O With push-in connection

Ordering data		
Type	Order No.	Pcs. / Pkt.
RIF-0-BPT/21	2900958	10

Plug-in bridge
2-pos. red
2-pos. blue
2-pos. gray
5-pos. red
10-pos. red
20-pos. red
50-pos. red

Accessories

FBS 2-6	3030336	50
FBS 2-6 BU	3036932	50
FBS 2-6 GY	3032237	50
FBS 5-6	3030349	50
FBS 10-6	3030271	10
FBS 20-6	3030365	10
FBS 50-6	3032224	10

End clamp, to snap on NS 35, 9.5 mm wide, can be labeled with ZB 6, ZB 8/27, KLM...

CLIPFIX 35	3022218	50
------------	---------	----

Test plug, consisting of:
Metal part for 2.3 mm Ø socket hole and
Insulating sleeve , for MPS metal part
red
white
blue
yellow
green
gray
black

MPS-MT	0201744	10
MPS-IH RD	0201676	10
MPS-IH WH	0201663	10
MPS-IH BU	0201689	10
MPS-IH YE	0201692	10
MPS-IH GN	0201702	10
MPS-IH GY	0201728	10
MPS-IH BK	0201731	10

Zack marker strip, 10-section, unprinted: pack contains enough to label 100 terminal blocks

ZB 6:UNBEDRUCKT	1051003	10
-----------------	---------	----

10-section

N



**1 N/O contact relay base for
miniature power relay**

Technical data

230 V AC
max. 8 A (Depends on application/assembly)

-40°C ... 85°C (Depends on application/assembly)

0.14 ... 1.5 mm² / 0.14 ... 1.5 mm² / 26 - 16

6.2 mm
66 mm
93 mm

Ordering data

Type	Order No.	Pcs. / Pkt.
RIF-0-BPT/1	2901873	10

Accessories

FBS 2-6	3030336	50
FBS 2-6 BU	3036932	50
FBS 2-6 GY	3032237	50
FBS 5-6	3030349	50
FBS 10-6	3030271	10
FBS 20-6	3030365	10
FBS 50-6	3032224	10
CLIPFIX 35	3022218	50
MPS-MT	0201744	10
MPS-IH RD	0201676	10
MPS-IH WH	0201663	10
MPS-IH BU	0201689	10
MPS-IH YE	0201692	10
MPS-IH GN	0201702	10
MPS-IH GY	0201728	10
MPS-IH BK	0201731	10
ZB 6:UNBEDRUCKT	1051003	10

Plug-in miniature power relays

Plug-in miniature power relays suitable for RIF-0 and PLC-INTERFACE relay bases.

The advantages:

- Power contacts up to 6 A
- Multi-layer gold contact or power contact
- High degree of protection RT III (comparable with IP67)
- Safe isolation according to DIN EN 50178 between coil and contact
- Can be soldered in on PCB



1 PDT

Notes:
If the specified maximum values for multi-layer contact relays are exceeded, the gold plating is destroyed. The maximum values of the power contact relay are then valid. This can result in a shorter service life than with a pure power contact.
For dimensional drawings and perforations for assembly, see page 344

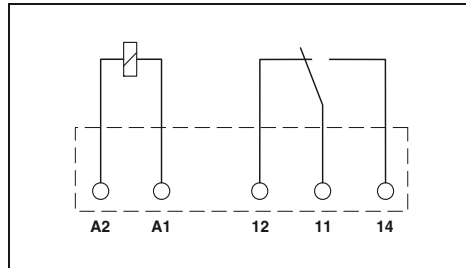

Technical data

Input data	①	②
Permissible range (with reference to U_N)	refer to the diagram	
Typ. input current at U_N	14	7
Typ. response time at U_N	5	5
Typ. release time at U_N	2.5	2.5
Output data		
Contact type	Single contact, 1-PDT	Single contact, 1-PDT
Contact material	AgSnO	AgSnO, hard gold-plated
Max. switching voltage	250 V AC/DC	30 V AC / 36 V DC
Min. switching voltage	5 V (at 100 mA)	100 mV (at 10 mA)
Limiting continuous current	6 A	50 mA
Max. inrush current	(on request)	50 mA
Min. switching current	10 mA (at 12 V)	1 mA (at 24 V)
General data		
Test voltage (winding / contact)	4 kV AC (50 Hz, 1 min.)	
Ambient temperature (operation)	-40°C ... 85°C	
Nominal operating mode	100% operating factor	
Mechanical service life	2 x 10 ⁷ cycles	
Standards/regulations	IEC 60664, EN 50178, IEC 62103	
Mounting position/mounting	Any / In rows with zero spacing	
Dimensions	5 mm / 28 mm / 15 mm	

Ordering data

Description	Input voltage U_N	Type	Order No.	Pcs. / Pkt.
Plug-in miniature power relays with power contact	① 12 V DC	REL-MR- 12DC/21	2961150	10
	② 24 V DC	REL-MR- 24DC/21	2961105	10
Plug-in miniature power relays with gold contact	① 12 V DC	REL-MR- 12DC/21AU	2961163	10
	② 24 V DC	REL-MR- 24DC/21AU	2961121	10

REL-MR-.../21... (1 PDT)

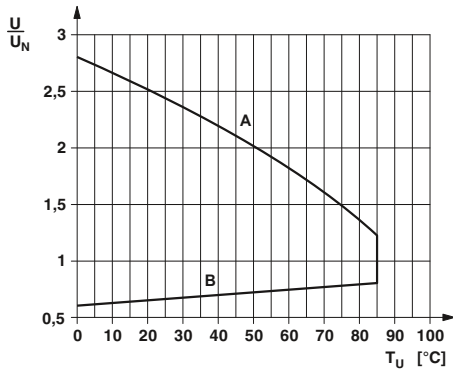

Interrupting rating

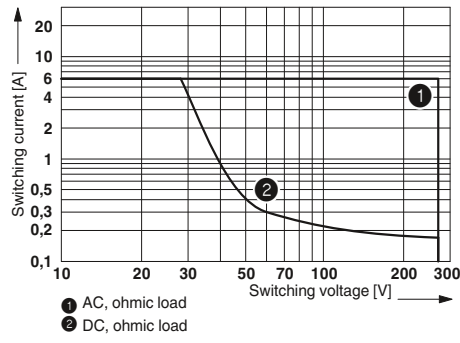

Relay modules

RIFLINE complete

Plug-in solid-state relays

Plug-in solid-state relays suitable for RIF-0 and PLC-INTERFACE relay bases.

The advantages:

- Switching capacity of up to 24 V DC/3 A
- RT III wash tight (comparable to IP67)
- Vibration- and shock-resistant
- Wear-free and long-lasting
- Zero voltage switch at AC output
- Can be soldered in on PCB

Notes:
For dimensional drawings and perforations for assembly, see page 345



Max. DC voltage output of 3 A

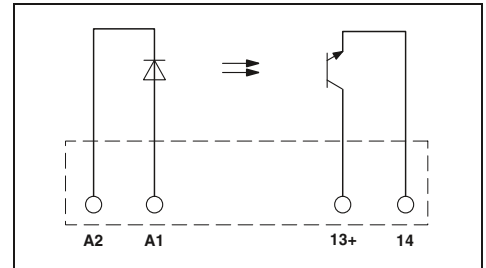

Technical data

Input data		①
Permissible range (with reference to U_N)		0,8 - 1,2
Switching level	1 signal ("H") [V DC] \geq 0 signal ("L") [V DC] \leq	16 10
Typ. input current at U_N	[mA]	7
Typ. switch-on time at U_N	[μ s]	20
Typ. switch-off time at U_N	[μ s]	300
Transmission frequency f_{limit}	[Hz]	300
Output data		
Max. switching voltage		33 V DC
Min. switching voltage		3 V DC
Limiting continuous current		3 A (see derating curve)
Min. load current		-
Max. inrush current		15 A (10 ms)
Leakage current in off state		-
Phase angle ($\cos \phi$)		-
Output circuit		2-conductor, floating
Max. load value		-
Output protection		Protection against polarity reversal, surge protection
Voltage drop at max. limiting continuous current		\leq 150 mV
General data		
Rated surge voltage		Basic insulation
Test voltage input/output		2,5 kV (50 Hz, 1 min.)
Ambient temperature (operation)		-25°C ... 60°C
Nominal operating mode		100% operating factor
Standards/regulations		IEC 60664, EN 50178, IEC 62103
Pollution degree/surge voltage category		2 / III
Mounting position/mounting		Any / In rows with zero spacing
Dimensions	W / H / D	5 mm / 28 mm / 15 mm

Ordering data

Description	Input voltage U_N	Type	Order No.	Pcs. / Pkt.
Plug-in solid-state relays				
Solid-state power relays	① 24 V DC	OPT-24DC/ 24DC/ 2	2966595	10
Plug-in solid-state relays				
Solid-state input relays	① 24 V DC			



Max. DC voltage output of 100 mA



Max. AC voltage output of 750 mA

Derating curve for OPT...DC/24DC/2 and PLC-OS.../24DC/2 solid-state relays

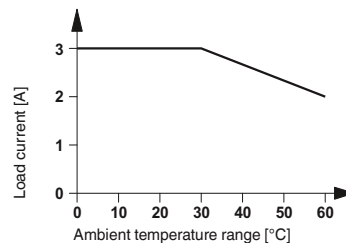

Derating curve for OPT...DC/230AC/1 and PLC-OS.../230AC/1 solid-state relays

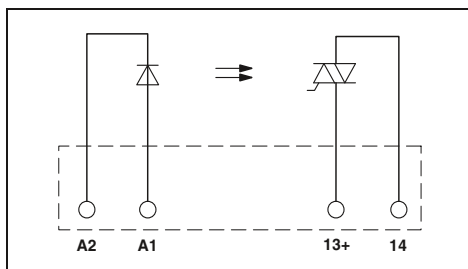
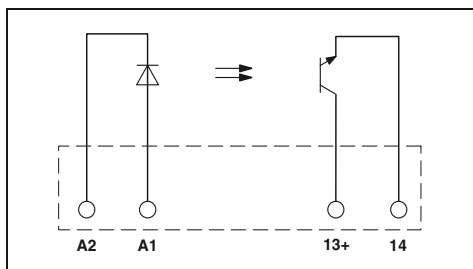
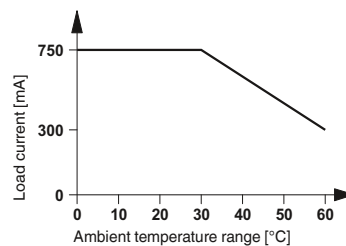

Technical data

Technical data

- ①
- 0.8 -
- 1.2
- 16
- 10
- 7
- 20
- 300
- 300

- ①
- 0.8 -
- 1.2
- 10
- 5
- 3
- 6000
- 500
- 10

48 V DC
 3 V DC
 100 mA
 -
 -
 -
 -
 -
 2-conductor, floating
 -
 Protection against polarity reversal, surge protection
 ≤ 1 V

253 V AC
 24 V AC
 0.75 A (see derating curve)
 10 mA
 30 A (10 ms)
 < 1 mA
 0.5
 2-conductor floating, zero voltage switch
 4.5 A²s
 RCV circuit
 < 1 V

Basic insulation
 2.5 kV (50 Hz, 1 min.)
 -25°C ... 60°C
 100% operating factor
 IEC 60664, EN 50178, IEC 62103
 2 / III
 Any / In rows with zero spacing
 5 mm / 28 mm / 15 mm

Basic insulation
 2.5 kV (50 Hz, 1 min.)
 -25°C ... 60°C
 100% operating factor
 IEC 60664, EN 50178, IEC 62103
 2 / III
 Any / In rows with zero spacing
 5 mm / 28 mm / 15 mm

Ordering data

Ordering data

Type	Order No.	Pcs. / Pkt.
OPT-24DC/ 48DC/100	2966618	10

Type	Order No.	Pcs. / Pkt.
OPT-24DC/230AC/ 1	2967950	10

Relay modules

RIFLINE complete

Modular RIF-1 relay base

Relay base that can be fitted with 1 or 2 PDT relays or solid-state relays.

Range of accessories includes:

- Plug-in input and interference suppression module
- Plug-in timer module
- Relay retaining bracket with ejector function and holder for marking material
- Comprehensive range of marking material
- Test plug
- FBS 2-6 plug-in bridges for the input side (A2)
- FBS 2-8 plug-in bridges for the output side (11/21)

Notes:
Type of insulating housing: Polyamide PA non-reinforced, color: gray.
For further marking systems and mounting material, see Catalog 5.

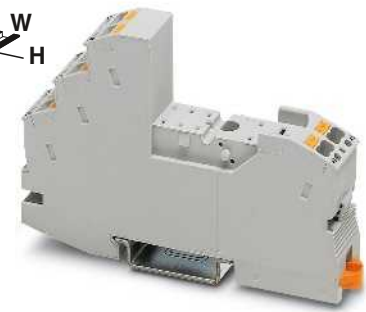

2 PDT relay base for miniature power relay

N

Nominal voltage U_N
Nominal current at U_N

Technical data
230 V AC max. 13 A (Depends on application/assembly)

General data
Ambient temperature (operation)
Connection data solid / stranded / AWG
Dimensions
Width
Depth with retaining bracket
Height

-40°C ... 85°C (Depends on application/assembly)
0.14 ... 1.5 mm ² / 0.14 ... 1.5 mm ² / 26 - 16
16 mm
75 mm
93 mm

Description
RIF-1 relay base , plug-in option for input/interference suppression module, safe isolation I/O with push-in connection
Relay retaining bracket , with ejector function and holder for marking material, suitable for RIF-1 relay base

Ordering data		
Type	Order No.	Pcs. / Pkt.
RIF-1-BPT/2X21	2900931	10

Plug-in bridge
2-pos. red
2-pos. blue
2-pos. gray
2-pos. red
2-pos. blue
2-pos. gray

End clamp, to snap on NS 35, 9.5 mm wide, can be labeled with ZB 6, ZB 8/27, KLM...

Test plug , consisting of:	
Metal part for 2.3 mm Ø socket hole and	
Insulating sleeve , for MPS metal part	red
	white
	blue
	yellow
	green
	gray
	black

Zack marker strip, unprinted	
10-section	
5-section	
Double marker carrier for ZB 5	

Accessories		
Type	Order No.	Pcs. / Pkt.
FBS 2-6	3030336	50
FBS 2-6 BU	3036932	50
FBS 2-6 GY	3032237	50
FBS 2-8	3030284	10
FBS 2-8 BU	3032567	10
FBS 2-8 GY	3032541	10
7042		
CLIPFIX 35	3022218	50
MPS-MT	0201744	10
MPS-IH RD	0201676	10
MPS-IH WH	0201663	10
MPS-IH BU	0201689	10
MPS-IH YE	0201692	10
MPS-IH GN	0201702	10
MPS-IH GY	0201728	10
MPS-IH BK	0201731	10
ZB 5 :UNBEDRUCKT	1050004	10
ZB 15:UNBEDRUCKT	0811972	10
STP 5-2	0800967	100

N



Relay retaining bracket

Technical data

-
-
-
-
-
-

Ordering data

Type	Order No.	Pcs. / Pkt.
RIF-RH-1	2900953	10

Accessories

Type	Order No.	Pcs. / Pkt.

Plug-in miniature power relays

Plug-in miniature power relays with 1 or 2 PDT contacts, suitable for RIF-1, PR1, and PLC-INTERFACE relay bases.

The advantages:

- Power contacts up to 16 A
- Multi-layer gold contact or power contact
- High degree of protection up to RT III (comparable with IP67) depending on type



1 PDT relay



2 PDT relay

Notes:
If the specified maximum values for multi-layer contact relays are exceeded, the gold plating is destroyed. The maximum values of the power contact relay are then valid. This can result in a shorter service life than with a pure power contact.

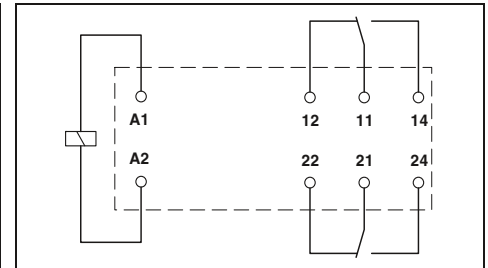
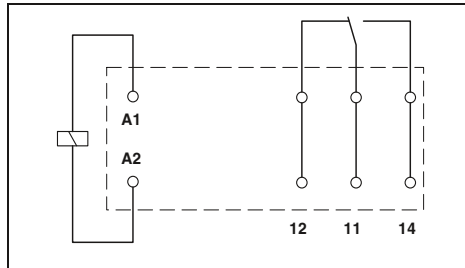

Technical data

①	②	③	④	⑤	⑥	⑦	⑧
refer to the diagram							
33	17	8.7	8.2	4.1	32	7	3
7	7	7	7	7	3-12	3-12	3-12
3	3	3	3	3	2-9	2-9	2-9

Technical data

①	②	③	④	⑤	⑥	⑦	⑧
refer to the diagram							
33	17	8.7	8.2	4.1	32	7	3
7	7	7	7	7	3-12	3-12	3-12
3	3	3	3	3	2-9	2-9	2-9

Input data	
Permissible range (with reference to U_N)	
Typ. input current at U_N	[mA]
Typ. response time at U_N	[ms]
Typ. response time at U_N (depending on phase relation)	[ms]
Typ. release time at U_N	[ms]
Typ. release time at U_N (depending on phase relation)	[ms]
Output data	
Contact type	
Contact material	
Max. switching voltage	
Min. switching voltage	
Limiting continuous current	
Max. inrush current, AC	
Max. inrush current, DC	
Min. switching current	
General data	
Test voltage (winding / contact)	
Test voltage (contact/contact)	
Ambient temperature (operation), AC	
Ambient temperature (operation), DC	
Mechanical service life, AC	
Mechanical service life, DC	
Standards/regulations	

①	②	③	④	⑤	⑥	⑦	⑧
refer to the diagram							
33	17	8.7	8.2	4.1	32	7	3
7	7	7	7	7	3-12	3-12	3-12
3	3	3	3	3	2-9	2-9	2-9

①	②	③	④	⑤	⑥	⑦	⑧
refer to the diagram							
33	17	8.7	8.2	4.1	32	7	3
7	7	7	7	7	3-12	3-12	3-12
3	3	3	3	3	2-9	2-9	2-9

Ordering data

Type	Order No.	Pcs. / Pkt.
REL-MR- 12DC/21HC	2961309	10
REL-MR- 24DC/21HC	2961312	10
REL-MR- 48DC/21HC	2834821	10
REL-MR- 60DC/21HC	2961325	10
REL-MR-110DC/21HC	2961338	10
REL-MR- 24AC/21HC	2961406	10
REL-MR-120AC/21HC	2961419	10
REL-MR-230AC/21HC	2961422	10
REL-MR- 12DC/21HC AU	2961532	10
REL-MR- 24DC/21HC AU	2961545	10
REL-MR-110DC/21HC AU	2961561	10
REL-MR- 24AC/21HC AU	2961503	10
REL-MR-120AC/21HC AU	2961516	10
REL-MR-230AC/21HC AU	2961529	10

Ordering data

Type	Order No.	Pcs. / Pkt.
REL-MR- 12DC/21-21	2961257	10
REL-MR- 24DC/21-21	2961192	10
REL-MR- 48DC/21-21	2834834	10
REL-MR- 60DC/21-21	2961273	10
REL-MR-110DC/21-21	2961202	10
REL-MR- 24AC/21-21	2961435	10
REL-MR-120AC/21-21	2961448	10
REL-MR-230AC/21-21	2961451	10
REL-MR- 12DC/21-21AU	2961299	10
REL-MR- 24DC/21-21AU	2961215	10
REL-MR- 48DC/21-21AU	2834847	10
REL-MR- 60DC/21-21AU	2961286	10
REL-MR-110DC/21-21AU	2961228	10
REL-MR- 24AC/21-21AU	2961464	10
REL-MR-120AC/21-21AU	2961477	10
REL-MR-230AC/21-21AU	2961480	10

Description	Input voltage U_N
Plug-in miniature power relays	
with power contact	① 12 V DC
with power contact	② 24 V DC
with power contact	③ 48 V DC
with power contact	④ 60 V DC
with power contact	⑤ 110 V DC
with power contact	⑥ 24 V AC
with power contact	⑦ 120 V AC
with power contact	⑧ 230 V AC
Plug-in miniature power relays	
with gold contact	① 12 V DC
with gold contact	② 24 V DC
with gold contact	③ 48 V DC
with gold contact	④ 60 V DC
with gold contact	⑤ 110 V DC
with gold contact	⑥ 24 V AC
with gold contact	⑦ 120 V AC
with gold contact	⑧ 230 V AC

REL-MR...21HC... (1 PDT)

Operating voltage range

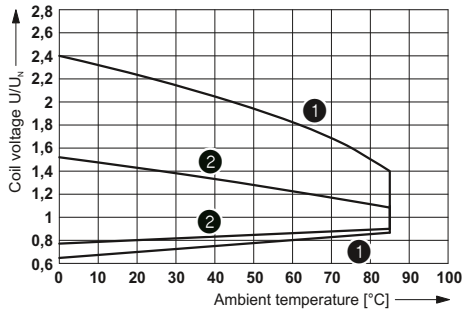

- 1 DC coils
- 2 AC coils

Interrupting rating

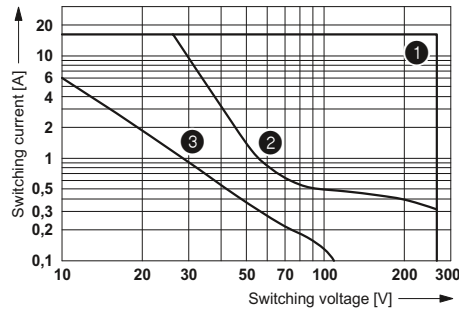

- 1 AC, ohmic load
- 2 DC, ohmic load
- 3 DC, L/R = 40 ms

Electrical service life

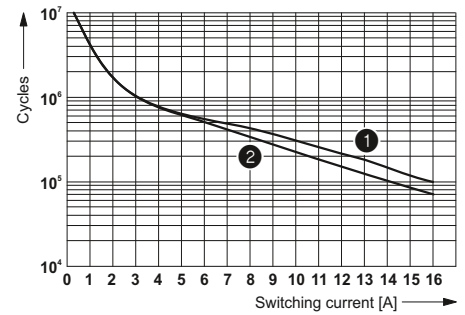

- 1 250 V AC, ohmic load (DC coils)
- 2 250 V AC, ohmic load (AC coils)

Service life reduction factor with various cos phi

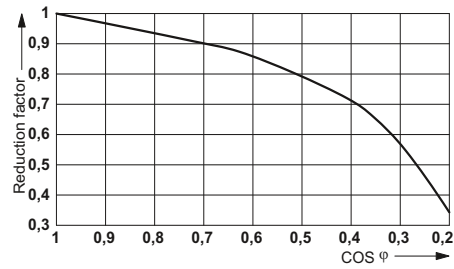

REL-MR...21-21... (2 PDTs)

Operating voltage range

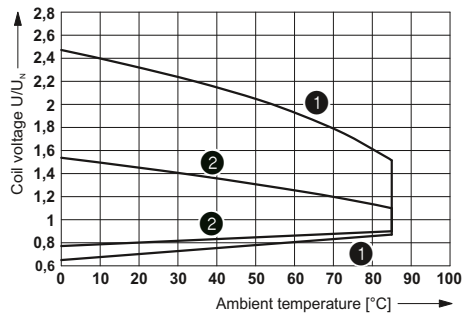

- 1 DC coils
- 2 AC coils

Interrupting rating

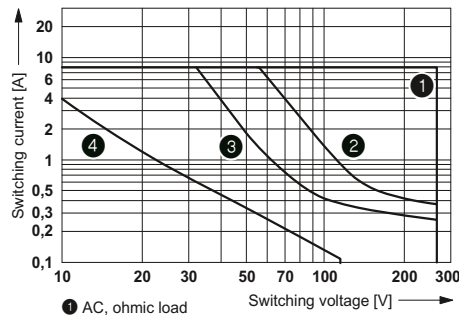

- 1 AC, ohmic load
- 2 DC, ohmic load, contacts in series
- 3 DC, ohmic load
- 4 DC, L/R = 40 ms

Electrical service life

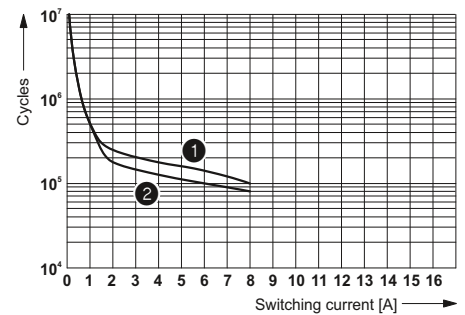

- 1 250 V AC, ohmic load (DC coils)
- 2 250 V AC, ohmic load (AC coils)

Service life reduction factor with various cos phi

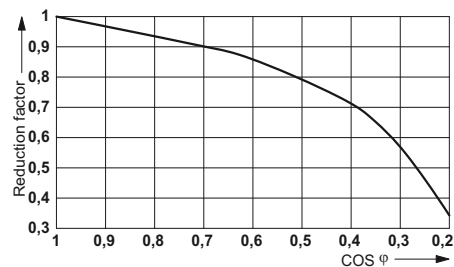

Relay modules

RIFLINE complete

Plug-in miniature power relays

Plug-in miniature power relays with 1 or 2 PDT contacts, suitable for RIF-1 and PR1 relay bases.

The advantages:

- Switching current of up to 16 A
- With lockable manual operation
- Mechanical switch position indicator
- Integrated status LED
- Multi-layer gold contact or power contact
- DC types with integrated freewheeling diode
- Can be soldered in on PCB



1 PDT relay



2 PDT relay

Notes:

If the specified maximum values for multi-layer contact relays are exceeded, the gold plating is destroyed. The maximum values of the power contact relay are then valid. This can result in a shorter service life than with a pure power contact.

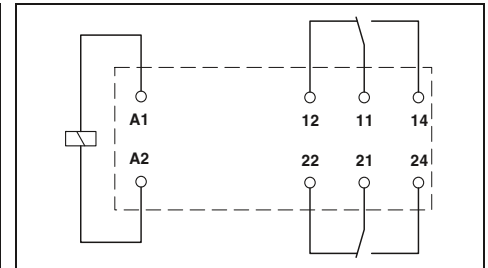
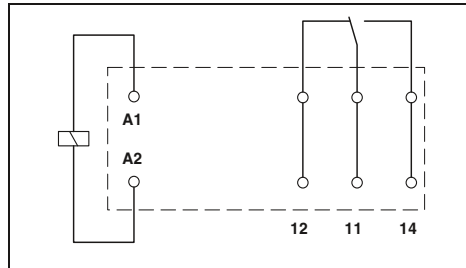

Technical data

①	②	③	④
refer to the diagram			
18	32	7	3.5
9		3 - 12	3 - 12
6		2 - 8	2 - 8

Technical data

①	②	③	④
refer to the diagram			
18	32	7	3.5
9		3 - 12	3 - 12
6		2 - 8	2 - 8

Input data	
Permissible range (with reference to U_N)	
Typ. input current at U_N	[mA]
Typ. response time at U_N	[ms]
Typ. response time at U_N (depending on phase relation)	[ms]
Typ. release time at U_N	[ms]
Typ. release time at U_N (depending on phase relation)	[ms]
Output data	
Contact type	
Contact material	
Max. switching voltage	
Min. switching voltage	
Limiting continuous current	
Max. inrush current, AC	
Max. inrush current, DC	
Min. switching current	
General data	
Test voltage (winding / contact)	
Test voltage (contact/contact)	
Ambient temperature (operation), AC	
Ambient temperature (operation), DC	
Mechanical service life, AC	
Mechanical service life, DC	
Standards/regulations	

Technical data	
Single contact, 1-PDT	Single contact, 1-PDT
AgNi	AgNi, hard gold-plated
250 V AC/DC	30 V AC / 36 V DC
12 V (at 10 mA)	12 V (At 1 mA)
16 A	50 mA
32 A (20 ms)	50 mA
32 A (20 ms)	50 mA
10 mA (at 12 V)	1 mA (at 12 V)
5 kV AC (50 Hz, 1 min.)	-
-	-
-40°C ... 70°C	-40°C ... 70°C
-40°C ... 70°C	-40°C ... 70°C
5 x 10 ⁶ cycles	5 x 10 ⁶ cycles
5 x 10 ⁶ cycles	5 x 10 ⁶ cycles
DIN EN 61810-1, VDE 0435-201, EN 50178, IEC 62103	DIN EN 61810-1, VDE 0435-201, EN 50178, IEC 62103

Technical data	
Single contact, 2-PDT	Single contact, 2-PDT
AgNi	AgNi, hard gold-plated
250 V AC/DC	30 V AC / 36 V DC
12 V (at 10 mA)	12 V (At 1 mA)
8 A	50 mA
16 A (20 ms)	50 mA
16 A (20 ms)	50 mA
10 mA (at 12 V)	1 mA (at 12 V)
5 kV AC (50 Hz, 1 min.)	5 kV AC (50 Hz, 1 min.)
2.5 kV AC (50 Hz, 1 min.)	2.5 kV AC (50 Hz, 1 min.)
-40°C ... 70°C	-40°C ... 70°C
-40°C ... 70°C	-40°C ... 70°C
5 x 10 ⁶ cycles	5 x 10 ⁶ cycles
5 x 10 ⁶ cycles	5 x 10 ⁶ cycles
DIN EN 61810-1, VDE 0435-201, EN 50178, IEC 62103	DIN EN 61810-1, VDE 0435-201, EN 50178, IEC 62103

Ordering data

Description	Input voltage U_N
Plug-in miniature power relays, with power contacts	
- Status LED, freewheeling diode A1+, A2-	① 24 V DC
- Status LED	② 24 V AC
- Status LED	③ 120 V AC
- Status LED	④ 230 V AC
Plug-in miniature power relays with manual test function, with hard gold-plated multi-layer contacts, mechanical switch position indicator	
- Status LED, freewheeling diode A1+, A2-	① 24 V DC
- Status LED	④ 230 V AC

Type	Order No.	Pcs. / Pkt.
REL-MR- 24DC/21HC/MS	2987888	10
REL-MR- 24AC/21HC/MS	2987891	10
REL-MR-120AC/21HC/MS	2987901	10
REL-MR-230AC/21HC/MS	2987914	10
REL-MR- 24DC/21HC AU/MS	2987927	10
REL-MR-230AC/21HC AU/MS	2987930	10

Ordering data

Type	Order No.	Pcs. / Pkt.
REL-MR- 24DC/21-21/MS	2987943	10
REL-MR- 24AC/21-21/MS	2987956	10
REL-MR-120AC/21-21/MS	2987969	10
REL-MR-230AC/21-21/MS	2987972	10
REL-MR- 24DC/21-21AU/MS	2987985	10
REL-MR-230AC/21-21AU/MS	2987998	10

REL-MR...21HC...MS (1 PDT)

Operating voltage range

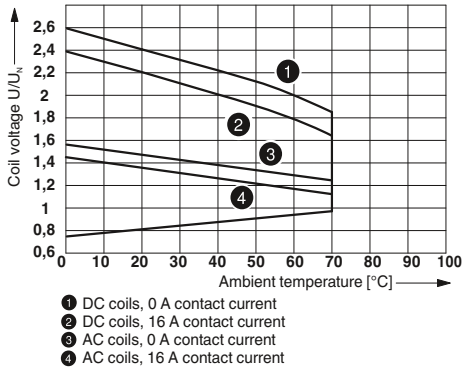

Interrupting rating

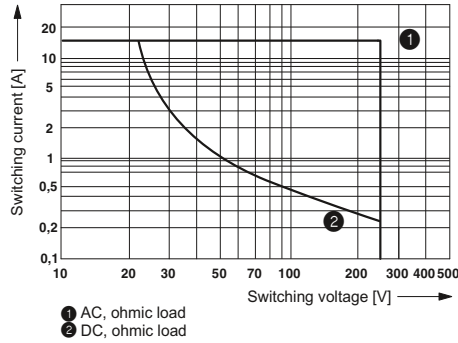

Electrical service life

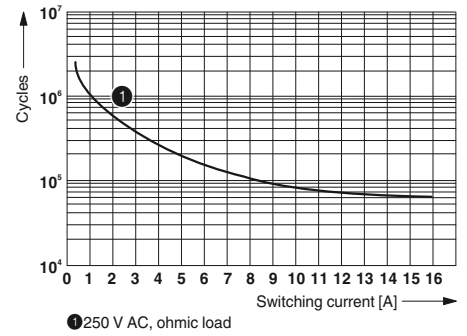

Service life reduction factor with various cos phi

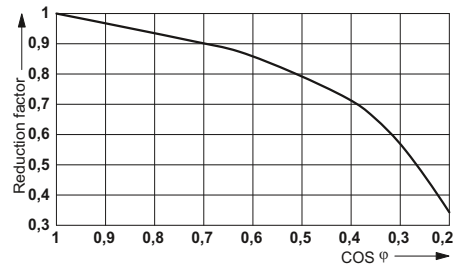

REL-MR...21-21...MS (2 PDTs)

Operating voltage range

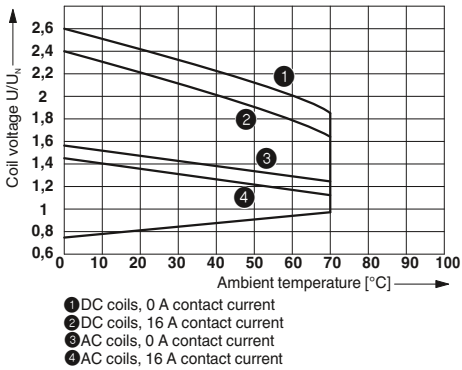

Interrupting rating

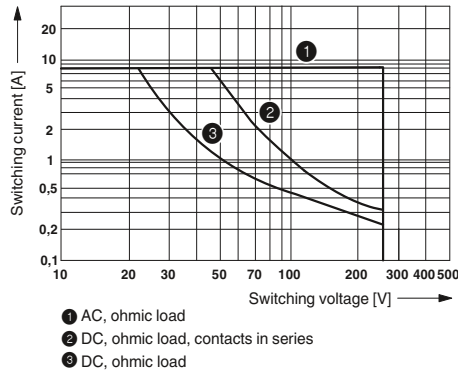

Electrical service life

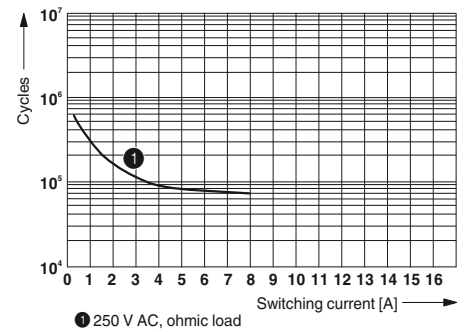

Service life reduction factor with various cos phi

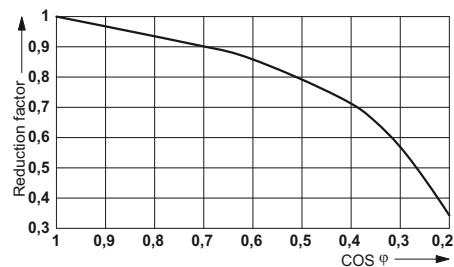

Plug-in solid-state relays

Plug-in solid-state relays suitable for RIF-1, PR1, and PLC-INTERFACE relay bases.

The advantages:

- Switching capacity of up to 24 V DC/5 A
- RT III wash tight (comparable to IP67)
- Vibration- and shock-resistant
- Wear-free and long-lasting
- Zero voltage switch at AC output
- Can be soldered in on PCB

Notes:

For dimensional drawings and perforations for assembly, see page 345



Max. DC voltage output of 5 A

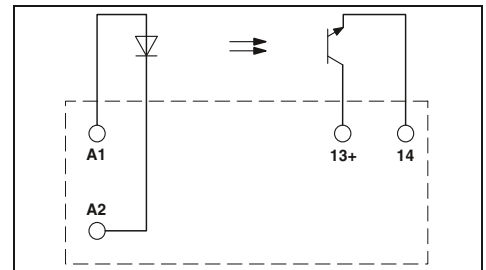

Technical data

Input data		①	②	③
Permissible range (with reference to U_N)		0.8 - 1.2	0.8 - 1.2	0.9 - 1.1
Switching level		1 signal ("H") [V DC] \geq	2.5	16
		0 signal ("L") [V DC] \leq	0.8	10
Typ. input current at U_N		[mA]	9	7
Typ. switch-on time at U_N		[μ s]	10	20
Typ. switch-off time at U_N		[μ s]	400	400
Transmission frequency f_{limit}		[Hz]	300	300
Output data				
Max. switching voltage		33 V DC		
Min. switching voltage		3 V DC		
Limiting continuous current		5 A (see derating curve)		
Min. load current		-		
Max. inrush current		15 A (10 ms)		
Leakage current in off state		-		
Phase angle (cos ϕ)		-		
Output circuit		2-conductor, floating		
Max. load value		-		
Output protection		Protection against polarity reversal, surge protection		
Voltage drop at max. limiting continuous current		\leq 200 mV		
General data				
Rated surge voltage		Basic insulation		
Test voltage input/output		2.5 kV (50 Hz, 1 min.)		
Ambient temperature (operation)		-25°C ... 60°C		
Nominal operating mode		100% operating factor		
Standards/regulations		IEC 60664, EN 50178, IEC 62103		
Pollution degree/surge voltage category		2 / III		
Mounting position/mounting		Any / In rows with zero spacing		
Dimensions		W / H / D 12.7 mm / 29 mm / 15.7 mm		

Ordering data

Description	Input voltage U_N	Type	Order No.	Pcs. / Pkt.
Plug-in solid-state relays	① 5 V DC	OPT-5DC/24DC/5	2982113	10
	② 24 V DC	OPT-24DC/24DC/5	2982100	10
	③ 60 V DC	OPT-60DC/24DC/5	2982126	10



Max. AC voltage output of 2 mA

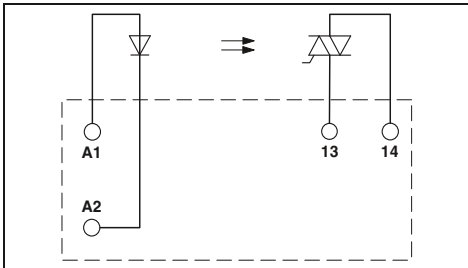

Technical data

①	②	③
0.8 -	0.8 -	0.9 -
1.2	1.2	1.1
3	18	40
1	8.4	20
15	7	2.6
10000	10000	10000
10000	10000	10000
10	10	10

253 V AC
 24 V AC
 2 A (see derating curve)
 25 mA
 30 A (10 ms)
 < 1 mA
 -
 2-conductor floating, zero voltage switch
 4 A²s (tp = 10 ms, at 25°C)
 Surge protection
 ≤ 1 V

Basic insulation
 2.5 kV (50 Hz, 1 min.)
 -25°C ... 60°C
 100% operating factor
 IEC 60664, EN 50178, IEC 62103
 2 / III
 Any / See derating curve
 12.7 mm / 29 mm / 15.7 mm

Ordering data

Type	Order No.	Pcs. / Pkt.
OPT-5DC/230AC/ 2	2982168	10
OPT-24DC/230AC/ 2	2982171	10
OPT-60DC/230AC/ 2	2982184	10

Derating curve for OPT...DC/24DC/5 solid-state relays

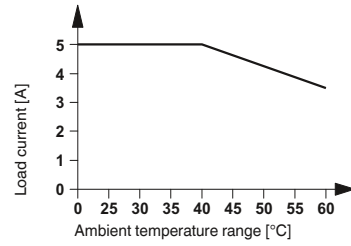

Derating curve for OPT...DC/230AC/2 solid-state relays

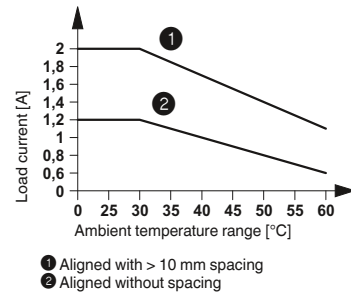

- ① Aligned with > 10 mm spacing
- ② Aligned without spacing

Relay modules

RIFLINE complete

Modular RIF-2 relay base

Relay base that can be fitted with 2 or 4 PDT relays.

Range of accessories includes:

- Plug-in input and interference suppression module
- Plug-in timer module
- Relay retaining bracket with ejector function and holder for marking material
- Comprehensive range of marking material
- Test plug
- FBS 2-6 plug-in bridges for the input side (A2)

Notes:
Type of insulating housing: Polyamide PA non-reinforced, color: gray.
For further marking systems and mounting material, see Catalog 5.



4 PDT relay base for industrial relay

N

Nominal voltage U_N
Nominal current at U_N

250 V AC
max. 12 A (Depends on application/assembly)

General data
Ambient temperature (operation)

-40°C ... 85°C (Depends on application/assembly)

Connection data solid / stranded / AWG
Dimensions
Width
Depth with retaining bracket
Height

0.14 ... 1.5 mm² / 0.14 ... 1.5 mm² / 26 - 16
31 mm
75 mm
93 mm

Description
RIF-2 relay base, plug-in option for input/interference suppression module, safe isolation I/O with push-in connection

Relay retaining bracket, with ejector function and holder for marking material, suitable for RIF-2 relay base

Plug-in bridge
2-pos. red
2-pos. blue
2-pos. gray
End clamp, to snap on NS 35, 9.5 mm wide, can be labeled with ZB 6, ZB 8/27, KLM...

Test plug, consisting of:
Metal part for 2.3 mm Ø socket hole and

Insulating sleeve, for MPS metal part

red
white
blue
yellow
green
gray
black

Zack marker strip, unprinted
10-section
5-section

Double marker carrier for ZB 5

Ordering data		
Type	Order No.	Pcs. / Pkt.
RIF-2-BPT/4X21	2900934	10

Accessories		
Type	Order No.	Pcs. / Pkt.
FBS 2-6	3030336	50
FBS 2-6 BU	3036932	50
FBS 2-6 GY	3032237	50
CLIPFIX 35	3022218	50
MPS-MT	0201744	10
MPS-IH RD	0201676	10
MPS-IH WH	0201663	10
MPS-IH BU	0201689	10
MPS-IH YE	0201692	10
MPS-IH GN	0201702	10
MPS-IH GY	0201728	10
MPS-IH BK	0201731	10
ZB 5 :UNBEDRUCKT	1050004	10
ZB 15:UNBEDRUCKT	0811972	10
STP 5-2	0800967	100

N



Relay retaining bracket

Technical data

-
-
-
-
-
-

Ordering data

Type	Order No.	Pcs. / Pkt.
RIF-RH-2	2900954	10

Accessories

Plug-in industrial relays with 2 or 4 PDT contacts, suitable for RIF-2 and PR2 relay bases.

The advantages:

- Detectable manual operation
- Mechanical switch position indicator
- Integrated status LED
- Multi-layer gold contact or power contact
- DC types with integrated freewheeling diode



2 PDT relay



4 PDT relay

Notes:
For other voltages, see www.phoenixcontact.net/products

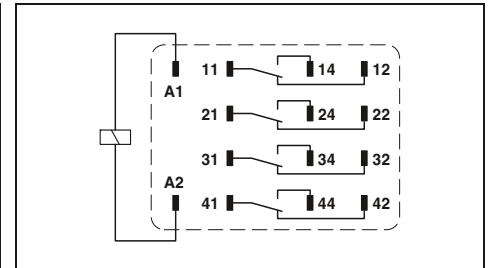
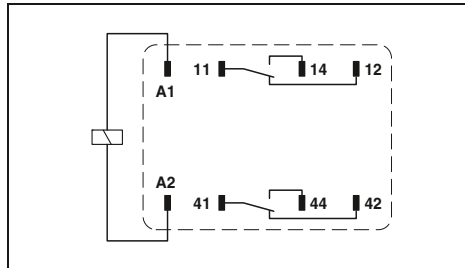

Technical data	
	① ② ③ ④ ⑤ ⑥ ⑦ ⑧
Input data	refer to the diagram
Permissible range (with reference to U_N)	
Typ. input current at U_N [mA]	78 41 22 18 8 70 13 6.5
Typ. response time at U_N [ms]	13 13 13 13 13
Typ. response time at U_N (depending on phase relation) [ms]	5 - 15 5 - 15 5 - 15
Typ. release time at U_N [ms]	14 14 14 14 14
Typ. release time at U_N (depending on phase relation) [ms]	5 - 20 5 - 20 5 - 20
Output data	
Contact type	Single contact, 2-PDT
Contact material	AgNi
Max. switching voltage	250 V AC/DC
Min. switching voltage	5 V (At 24 mA)
Limiting continuous current	12 A
Max. inrush current, AC	30 A (20 ms, N/O contact)
Max. inrush current, DC	30 A (20 ms, N/O contact)
Min. switching current	5 mA (at 24 V)
General data	
Test voltage (winding / contact)	2.5 kV _{rms} (50 Hz, 1 min.)
Ambient temperature (operation), AC	-40°C ... 55°C
Ambient temperature (operation), DC	-40°C ... 70°C
Mechanical service life, AC	Approx. 2×10^7 cycles
Mechanical service life, DC	Approx. 2×10^7 cycles
Standards/regulations	IEC 60664

Technical data	
	① ② ③ ④ ⑤ ⑥ ⑦ ⑧
Input data	refer to the diagram
Permissible range (with reference to U_N)	
Typ. input current at U_N [mA]	78 41 22 18 8 70 13 6.5
Typ. response time at U_N [ms]	13 13 13 13 13
Typ. response time at U_N (depending on phase relation) [ms]	5 - 15 5 - 15 5 - 15
Typ. release time at U_N [ms]	14 14 14 14 14
Typ. release time at U_N (depending on phase relation) [ms]	5 - 20 5 - 20 5 - 20
Output data	
Contact type	Single contact, 2-PDT
Contact material	AgNi
Max. switching voltage	250 V AC/DC
Min. switching voltage	5 V (At 24 mA)
Limiting continuous current	12 A
Max. inrush current, AC	30 A (20 ms, N/O contact)
Max. inrush current, DC	30 A (20 ms, N/O contact)
Min. switching current	5 mA (at 24 V)
General data	
Test voltage (winding / contact)	2.5 kV _{rms} (50 Hz, 1 min.)
Ambient temperature (operation), AC	-40°C ... 55°C
Ambient temperature (operation), DC	-40°C ... 70°C
Mechanical service life, AC	Approx. 2×10^7 cycles
Mechanical service life, DC	Approx. 2×10^7 cycles
Standards/regulations	IEC 60664

Technical data	
	① ② ③ ④ ⑤ ⑥ ⑦ ⑧
Input data	refer to the diagram
Permissible range (with reference to U_N)	
Typ. input current at U_N [mA]	78 41 22 18 8 70 13 6.5
Typ. response time at U_N [ms]	13 13 13 13 13
Typ. response time at U_N (depending on phase relation) [ms]	5 - 15 5 - 15 5 - 15
Typ. release time at U_N [ms]	14 14 14 14 14
Typ. release time at U_N (depending on phase relation) [ms]	5 - 20 5 - 20 5 - 20
Output data	
Contact type	Single contact, 4-PDT
Contact material	AgNi, hard gold-plated
Max. switching voltage	30 V AC / 36 V DC
Min. switching voltage	5 V (At 24 mA)
Limiting continuous current	50 mA
Max. inrush current, AC	50 mA
Max. inrush current, DC	50 mA
Min. switching current	-
General data	
Test voltage (winding / contact)	2.5 kV _{rms} (50 Hz, 1 min.)
Ambient temperature (operation), AC	-40°C ... 55°C
Ambient temperature (operation), DC	-40°C ... 70°C
Mechanical service life, AC	Approx. 2×10^7 cycles
Mechanical service life, DC	Approx. 2×10^7 cycles
Standards/regulations	IEC 60664

Ordering data	
Description	Input voltage U_N
Plug-in industrial relays, with power contacts	
With freewheeling diode	① 12 V DC
With freewheeling diode	② 24 V DC
With freewheeling diode	③ 48 V DC
With freewheeling diode	④ 60 V DC
With freewheeling diode	⑤ 110 V DC
	⑥ 24 V AC
	⑦ 120 V AC
	⑧ 230 V AC
Plug-in industrial relays, with multi-layer gold contacts	
With freewheeling diode	① 12 V DC
With freewheeling diode	② 24 V DC
With freewheeling diode	③ 48 V DC
With freewheeling diode	④ 60 V DC
With freewheeling diode	⑤ 110 V DC
	⑥ 24 V AC
	⑦ 120 V AC
	⑧ 230 V AC

Ordering data		
Type	Order No.	Pcs. / Pkt.
REL-IR2/LDP- 12DC/2X21	2903659	10
REL-IR2/LDP- 24DC/2X21	2903660	10
REL-IR2/LDP- 48DC/2X21	2903661	10
REL-IR2/LDP- 60DC/2X21	2903662	10
REL-IR2/LDP-110DC/2X21	2903663	10
REL-IR2/L- 24AC/2X21	2903666	10
REL-IR2/L-120AC/2X21	2903667	10
REL-IR2/L-230AC/2X21	2903668	10

Ordering data		
Type	Order No.	Pcs. / Pkt.
REL-IR4/LDP- 12DC/4X21	2903676	10
REL-IR4/LDP- 24DC/4X21	2903677	10
REL-IR4/LDP- 48DC/4X21	2903678	10
REL-IR4/LDP- 60DC/4X21	2903679	10
REL-IR4/LDP-110DC/4X21	2903680	10
REL-IR4/L- 24AC/4X21	2903686	10
REL-IR4/L-120AC/4X21	2903687	10
REL-IR4/L-230AC/4X21	2903688	10
REL-IR4/LDP- 12DC/4X21AU	2903669	10
REL-IR4/LDP- 24DC/4X21AU	2903670	10
REL-IR4/LDP- 48DC/4X21AU	2903671	10
REL-IR4/LDP- 60DC/4X21AU	2903672	10
REL-IR4/LDP-110DC/4X21AU	2903673	10
REL-IR4/L- 24AC/4X21AU	2903683	10
REL-IR4/L-120AC/4X21AU	2903684	10
REL-IR4/L-230AC/4X21AU	2903685	10

REL-IR2... (2 PDTs)

Operating voltage range

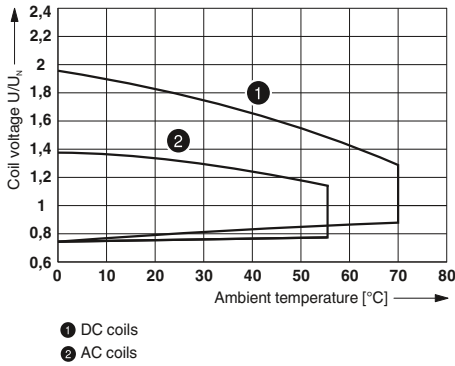

Interrupting rating

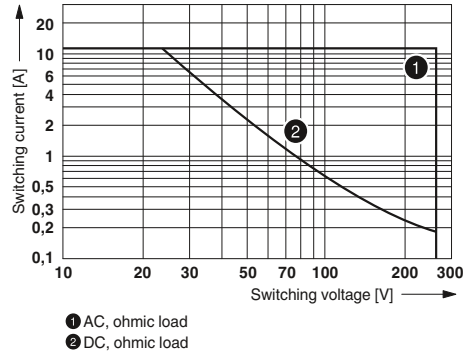

Electrical service life

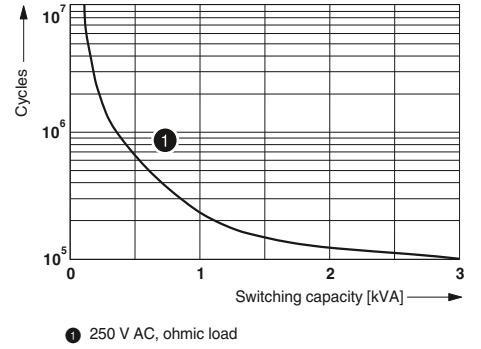

Service life reduction factor

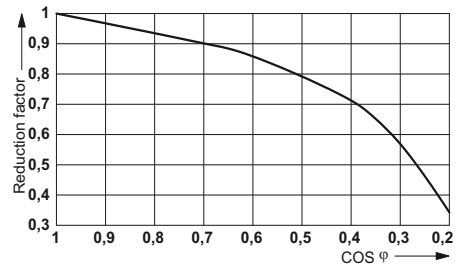

REL-IR4... (4 PDTs)

Operating voltage range

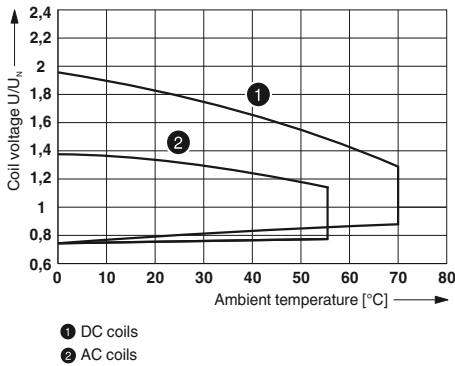

Interrupting rating

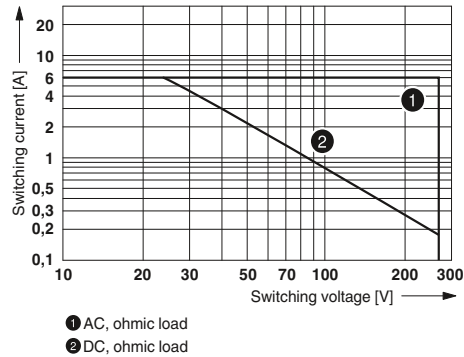

Electrical service life

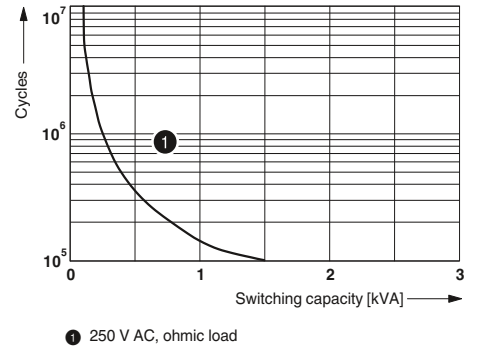

Service life reduction factor

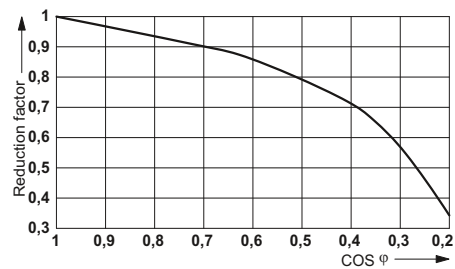

Modular RIF-3 relay base

Relay base that can be fitted with 2 or 3 PDT relays.

Range of accessories includes:

- Plug-in input and interference suppression module
- Plug-in timer module
- Relay retaining bracket with ejector function and holder for marking material
- Comprehensive range of marking material
- Test plug
- FBS 2-6 plug-in bridges for the input side (A2)

Notes:
Type of insulating housing: Polyamide PA non-reinforced, color: gray.
For further marking systems and mounting material, see Catalog 5.



2 PDT relay base for octal relay

N

Nominal voltage U_N
Nominal current at U_N

Technical data

250 V AC
max. 12 A (Depends on application/assembly)

General data
Ambient temperature (operation)
Connection data solid / stranded / AWG
Dimensions
Width
Depth with retaining bracket
Height

-40°C ... 85°C (Depends on application/assembly)
0.14 ... 1.5 mm² / 0.14 ... 1.5 mm² / 26 - 16
40 mm
90 mm
100 mm

Description
RIF-3 relay base , 2 PDT version, plug-in option for input/interference suppression module, safe isolation I/O with push-in connection
RIF-3 relay base , 3 PDT version, plug-in option for input/interference suppression module, safe isolation I/O with push-in connection
Relay retaining bracket , with holder for marking material, suitable for RIF-3 relay base

Ordering data

Type	Order No.	Pcs. / Pkt.
RIF-3-BPT/2X21	2900937	10

Plug-in bridge 2-pos. red 2-pos. blue 2-pos. gray End clamp , to snap on NS 35, 9.5 mm wide, can be labeled with ZB 6, ZB 8/27, KLM...	
Test plug , consisting of: Metal part for 2.3 mm Ø socket hole and Insulating sleeve , for MPS metal part	red white blue yellow green gray black
Zack marker strip , unprinted 10-section 5-section Double marker carrier for ZB 5	

Accessories

FBS 2-6 FBS 2-6 BU FBS 2-6 GY	3030336 3036932 3032237	50 50 50
CLIPFIX 35	3022218	50
MPS-MT	0201744	10
MPS-IH RD MPS-IH WH MPS-IH BU MPS-IH YE MPS-IH GN MPS-IH GY MPS-IH BK	0201676 0201663 0201689 0201692 0201702 0201728 0201731	10 10 10 10 10 10 10
ZB 5 :UNBEDRUCKT ZB 15:UNBEDRUCKT STP 5-2	1050004 0811972 0800967	10 10 100



3 PDT relay base for octal relay



Relay retaining bracket



Technical data
250 V AC
max. 12 A (Depends on application/assembly)
-40°C ... 85°C (Depends on application/assembly)
0.14 ... 1.5 mm ² / 0.14 ... 1.5 mm ² / 26 - 16
40 mm
90 mm
100 mm

Technical data
-
-
-
-
-
-

Ordering data		
Type	Order No.	Pcs. / Pkt.
RIF-3-BPT/3X21	2900938	10

Ordering data		
Type	Order No.	Pcs. / Pkt.
RIF-RH-3	2900955	10

Accessories		
FBS 2-6	3030336	50
FBS 2-6 BU	3036932	50
FBS 2-6 GY	3032237	50
CLIPFIX 35	3022218	50
MPS-MT	0201744	10
MPS-IH RD	0201676	10
MPS-IH WH	0201663	10
MPS-IH BU	0201689	10
MPS-IH YE	0201692	10
MPS-IH GN	0201702	10
MPS-IH GY	0201728	10
MPS-IH BK	0201731	10
ZB 5 :UNBEDRUCKT	1050004	10
ZB 15:UNBEDRUCKT	0811972	10
STP 5-2	0800967	100

Accessories		

Relay modules

RIFLINE complete

Plug-in octal relays

Plug-in octal relays with 2 or 3 PDT contacts, suitable for RIF-3 and PR3 relay bases.

The advantages:

- Detectable manual operation
- Mechanical switch position indicator
- Integrated status LED
- DC types with integrated freewheeling diode



2 PDT relay



3 PDT relay

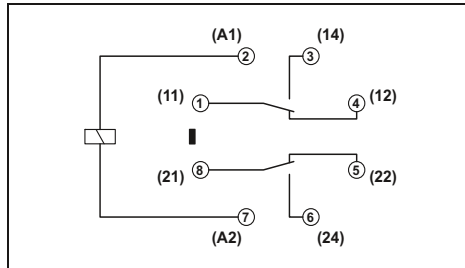

Technical data

	①	②	③	④
Permissible range (with reference to U_N)	refer to the diagram			
Typ. input current at U_N	[mA]	60	108	23
Typ. response time at U_N	[ms]	18		
Typ. response time at U_N (depending on phase relation)	[ms]		5 - 15	5 - 15
Typ. release time at U_N	[ms]			
Typ. release time at U_N (depending on phase relation)	[ms]		5 - 20	5 - 20

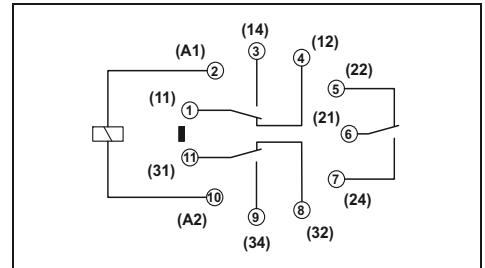

Technical data

	①	②	③	④
Permissible range (with reference to U_N)	refer to the diagram			
Typ. input current at U_N	[mA]	60	108	23
Typ. response time at U_N	[ms]	18		
Typ. response time at U_N (depending on phase relation)	[ms]		5 - 15	5 - 15
Typ. release time at U_N	[ms]			
Typ. release time at U_N (depending on phase relation)	[ms]		5 - 20	5 - 20

Input data	
Permissible range (with reference to U_N)	
Typ. input current at U_N	[mA]
Typ. response time at U_N	[ms]
Typ. response time at U_N (depending on phase relation)	[ms]
Typ. release time at U_N	[ms]
Typ. release time at U_N (depending on phase relation)	[ms]
Output data	
Contact type	Single contact, 2-PDT
Contact material	AgNi
Max. switching voltage	250 V AC/DC
Min. switching voltage	10 V (At 24 mA)
Limiting continuous current	10 A
Max. inrush current, AC	30 A (20 ms, N/O contact)
Max. inrush current, DC	30 A (20 ms, N/O contact)
Min. switching current	10 mA (at 24 V)
General data	
Test voltage (winding / contact)	2.5 kV _{rms} (50 Hz, 1 min.)
Ambient temperature (operation), AC	-40°C ... 55°C
Ambient temperature (operation), DC	-40°C ... 70°C
Nominal operating mode	100% operating factor
Mechanical service life, AC	Approx. 2 x 10 ⁷ cycles
Mechanical service life, DC	Approx. 2 x 10 ⁷ cycles
Standards/regulations	IEC 60664
Mounting position/mounting	Any
Dimensions	W / H / D 35 mm / 54.4 mm / 35 mm

Ordering data

Type	Order No.	Pcs. / Pkt.
REL-OR2/LDP- 24DC/2X21	2903689	10
REL-OR2/L- 24AC/2X21	2903690	10
REL-OR2/L-120AC/2X21	2903691	10
REL-OR2/L-230AC/2X21	2903692	10

Ordering data

Type	Order No.	Pcs. / Pkt.
REL-OR3/LDP-24DC/3X21	2903693	10
REL-OR3/L- 24AC/3X21	2903694	10
REL-OR3/L-120AC/3X21	2903695	10
REL-OR3/L-230AC/3X21	2903696	10

Description	Input voltage U_N
Plug-in octal relays, with power contacts	
With freewheeling diode	① 24 V DC
	② 24 V AC
	③ 120 V AC
	④ 230 V AC

REL-OR2... (2 PDTs)

Operating voltage range

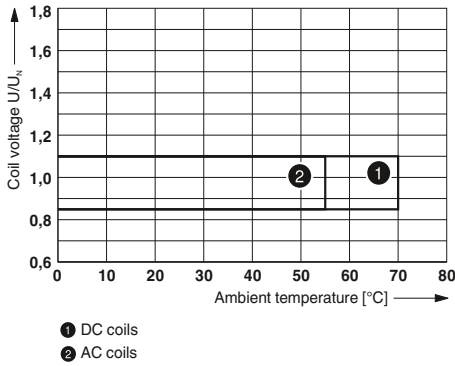

Interrupting rating

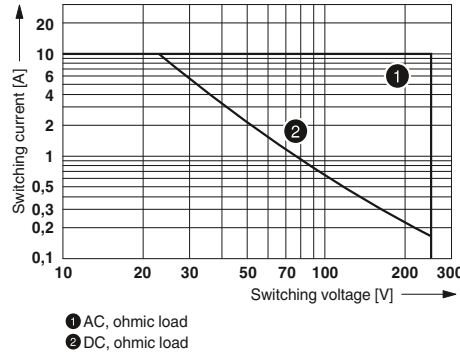

Electrical service life

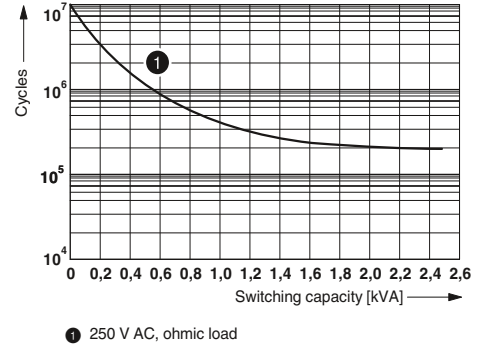

Service life reduction factor

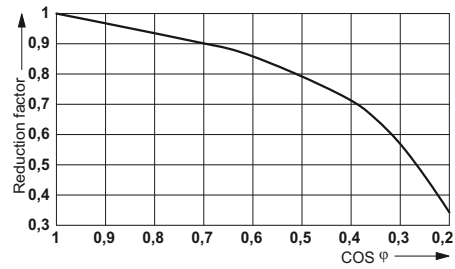

REL-OR3... (3 PDTs)

Operating voltage range

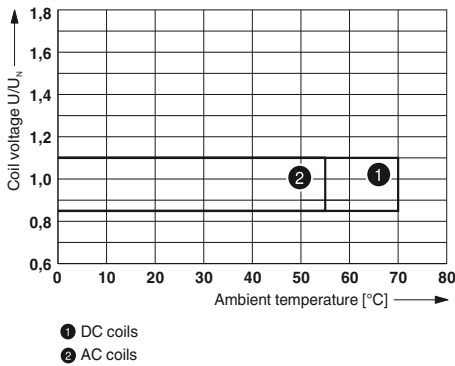

Interrupting rating

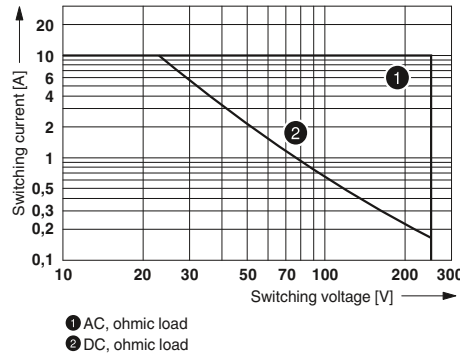

Electrical service life

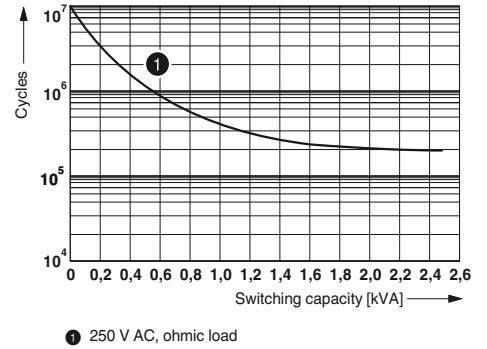

Service life reduction factor

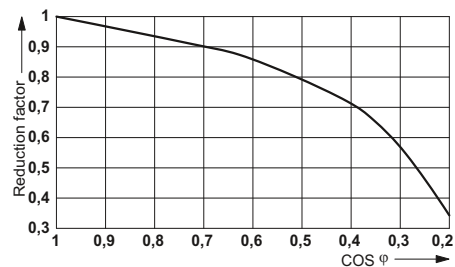

Modular RIF-4 relay base

Relay base that can be fitted with 2 or 3 PDT relays or 3 N/O relays.

Range of accessories includes:

- Plug-in input and interference suppression module
- Plug-in timer module
- Relay retaining bracket with ejector function and holder for marking material
- Comprehensive range of marking material
- Test plug
- FBS 2-6 plug-in bridges for the input side (A2)

Notes:
Type of insulating housing: Polyamide PA non-reinforced, color: gray.
For further marking systems and mounting material, see Catalog 5.

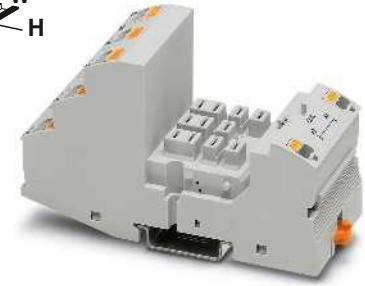

3 PDT relay base for high-power relay

N

Nominal voltage U_N
Nominal current at U_N

Technical data	
400 V AC	max. 16 A (Depends on application/assembly)

General data	
Ambient temperature (operation)	
Connection data solid / stranded / AWG	
Input side	0.14 ... 1.5 mm ² / 0.14 ... 1.5 mm ² / 26 - 16
Output side	0.14 ... 2.5 mm ² / 0.14 ... 2.5 mm ² / 26 - 14
Dimensions	
Width	43 mm
Depth with retaining bracket	90 mm
Height	107 mm

-40°C ... 85°C (Depends on application/assembly)
--

Description	
RIF-4 relay base , plug-in option for input/interference suppression module, safe isolation I/O with push-in connection	
Relay retaining bracket , with holder for marking material, suitable for RIF-4 relay base	

Ordering data		
Type	Order No.	Pcs. / Pkt.
RIF-4-BPT/3X21	2900961	10

Plug-in bridge	
2-pos. red	
2-pos. blue	
2-pos. gray	
End clamp , to snap on NS 35, 9.5 mm wide, can be labeled with ZB 6, ZB 8/27, KLM...	
Test plug , consisting of:	
Metal part for 2.3 mm Ø socket hole and	
Insulating sleeve , for MPS metal part	red white blue yellow green gray black

Accessories		
FBS 2-6	3030336	50
FBS 2-6 BU	3036932	50
FBS 2-6 GY	3032237	50
CLIPFIX 35	3022218	50
MPS-MT	0201744	10
MPS-IH RD	0201676	10
MPS-IH WH	0201663	10
MPS-IH BU	0201689	10
MPS-IH YE	0201692	10
MPS-IH GN	0201702	10
MPS-IH GY	0201728	10
MPS-IH BK	0201731	10
ZB 5 :UNBEDRUCKT	1050004	10
ZB 15:UNBEDRUCKT	0811972	10
STP 5-2	0800967	100

Zack marker strip, unprinted	
10-section	
5-section	
Double marker carrier for ZB 5	

N



Relay retaining bracket

Technical data

-
-
-
-
-
-
-

Ordering data

Type	Order No.	Pcs. / Pkt.
RIF-RH-4	2900956	10

Accessories

Type	Order No.	Pcs. / Pkt.

Relay modules

RIFLINE complete

Plug-in high-power relays

Plug-in high-power relays with 2 or 3 PDT contacts for the RIF-4 relay base.

The advantages:

- Use in miniature contactor applications
- Switching current of up to 16 A
- Up to 440 V AC switching voltage



2 PDT relay



3 PDT relay

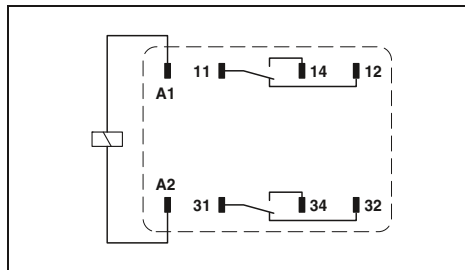

Technical data

	①	②	③	④
refer to the diagram				
Typ. input current at U_N	56	116	23	12
Typ. response time at U_N	20			
Typ. response time at U_N (depending on phase relation)		5 - 25	5 - 25	5 - 25
Typ. release time at U_N	15			
Typ. release time at U_N (depending on phase relation)		5 - 20	5 - 20	5 - 20

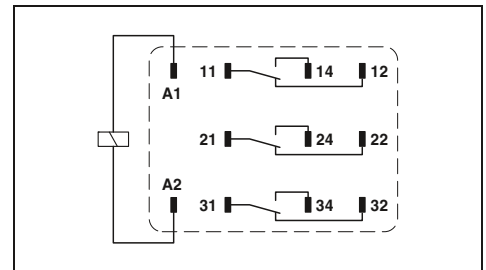

Technical data

	①	②	③	④
refer to the diagram				
Typ. input current at U_N	56	116	23	12
Typ. response time at U_N	20			
Typ. response time at U_N (depending on phase relation)		5 - 25	5 - 25	5 - 25
Typ. release time at U_N	15			
Typ. release time at U_N (depending on phase relation)		5 - 20	5 - 20	5 - 20

Input data	
Permissible range (with reference to U_N)	
Typ. input current at U_N	[mA]
Typ. response time at U_N	[ms]
Typ. response time at U_N (depending on phase relation)	[ms]
Typ. release time at U_N	[ms]
Typ. release time at U_N (depending on phase relation)	[ms]
Output data	
Contact type	Single contact, 2-PDT
Contact material	AgNi
Max. switching voltage	440 V AC / 250 V DC
Min. switching voltage	10 V (At 24 mA)
Limiting continuous current	16 A
Max. inrush current, AC	50 A (20 ms, N/O contact)
Max. inrush current, DC	50 A (20 ms, N/O contact)
Min. switching current	10 mA (at 24 V)
Max. interrupting rating, ohmic load	250 V AC 4000 VA 440 V AC 4000 VA
Motor load according to UL 508	1/3 HP, 120 V AC (single-phase AC motor) 1/2 HP, 240 V AC (single-phase AC motor)

Technical data	
refer to the diagram	
Typ. input current at U_N	[mA]
Typ. response time at U_N	[ms]
Typ. response time at U_N (depending on phase relation)	[ms]
Typ. release time at U_N	[ms]
Typ. release time at U_N (depending on phase relation)	[ms]
Output data	
Contact type	Single contact, three PDTs
Contact material	AgNi
Max. switching voltage	440 V AC / 250 V DC
Min. switching voltage	10 V (At 24 mA)
Limiting continuous current	16 A
Max. inrush current, AC	50 A (20 ms, N/O contact)
Max. inrush current, DC	50 A (20 ms, N/O contact)
Min. switching current	10 mA (at 24 V)
Max. interrupting rating, ohmic load	4000 VA 4000 VA
Motor load according to UL 508	1/3 HP, 120 V AC (single-phase AC motor) 1/2 HP, 240 V AC (single-phase AC motor) 1/2 HP, 240 V AC (three-phase induction motor)

General data	
Test voltage (winding / contact)	2.5 kV _{rms} (50 Hz, 1 min.)
Ambient temperature (operation), AC	-40°C ... 55°C
Ambient temperature (operation), DC	-40°C ... 70°C
Nominal operating mode	100% operating factor
Mechanical service life, AC	Approx. 10 ⁷ cycles
Mechanical service life, DC	Approx. 10 ⁷ cycles
Standards/regulations	IEC 60664
Mounting position/mounting	Any
Dimensions	W / H / D 38.6 mm / 45.5 mm / 36.1 mm

Technical data	
refer to the diagram	
Typ. input current at U_N	[mA]
Typ. response time at U_N	[ms]
Typ. response time at U_N (depending on phase relation)	[ms]
Typ. release time at U_N	[ms]
Typ. release time at U_N (depending on phase relation)	[ms]
Output data	
Contact type	Single contact, three PDTs
Contact material	AgNi
Max. switching voltage	440 V AC / 250 V DC
Min. switching voltage	10 V (At 24 mA)
Limiting continuous current	16 A
Max. inrush current, AC	50 A (20 ms, N/O contact)
Max. inrush current, DC	50 A (20 ms, N/O contact)
Min. switching current	10 mA (at 24 V)
Max. interrupting rating, ohmic load	4000 VA 4000 VA
Motor load according to UL 508	1/3 HP, 120 V AC (single-phase AC motor) 1/2 HP, 240 V AC (single-phase AC motor) 1/2 HP, 240 V AC (three-phase induction motor)

Description		Input voltage U_N
Plug-in high-power relays, 2 PDTs with power contacts		
	①	24 V DC
	②	24 V AC
	③	120 V AC
	④	230 V AC
Plug-in high-power relays, 3 PDTs with power contacts		
	①	24 V DC
	②	24 V AC
	③	120 V AC
	④	230 V AC

Ordering data		
Type	Order No.	Pcs. / Pkt.
REL-PR2- 24DC/2X21	2903698	1
REL-PR2- 24AC/2X21	2903699	1
REL-PR2-120AC/2X21	2903700	1
REL-PR2-230AC/2X21	2903701	1

Ordering data		
Type	Order No.	Pcs. / Pkt.
REL-PR3- 24DC/3X21	2903702	1
REL-PR3- 24AC/3X21	2903703	1
REL-PR3-120AC/3X21	2903704	1
REL-PR3-230AC/3X21	2903705	1

REL-PR2... (2 PDTs)

Operating voltage range

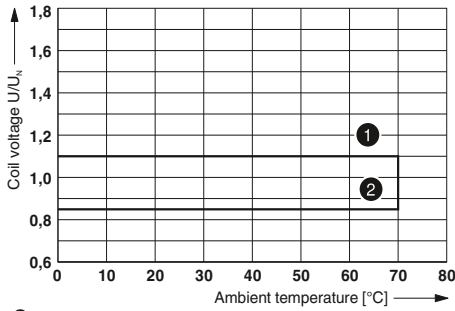

- 1 Maximum continuous voltage at limiting continuous current = 16 A
 - 2 Minimum operate voltage
- For pre-excitation with UN and limiting continuous current = 16 A

Interrupting rating

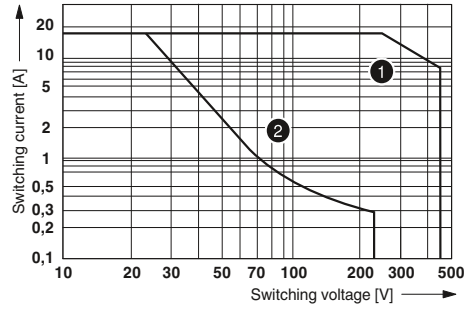

- 1 AC, ohmic load
- 2 DC, ohmic load

Electrical service life

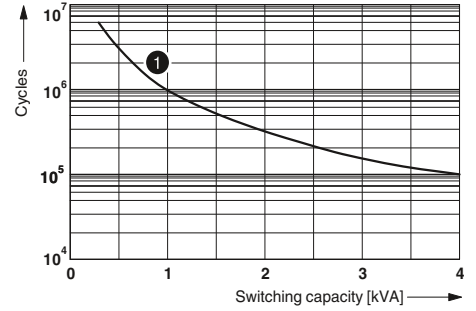

- 1 250 V AC, ohmic load

Service life reduction factor

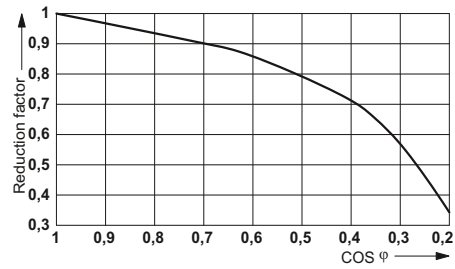

REL-PR3... (3 PDTs)

Operating voltage range

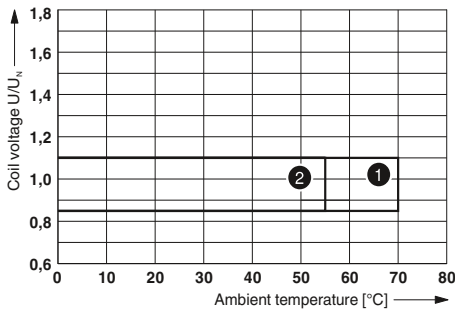

- 1 DC coils
- 2 AC coils

Interrupting rating

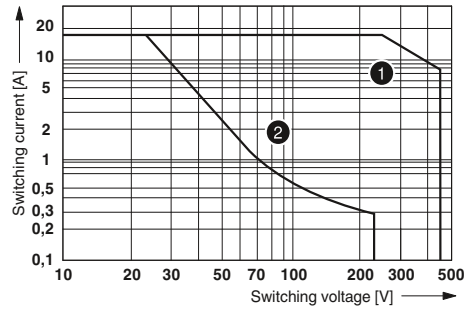

- 1 AC, ohmic load
- 2 DC, ohmic load

Electrical service life

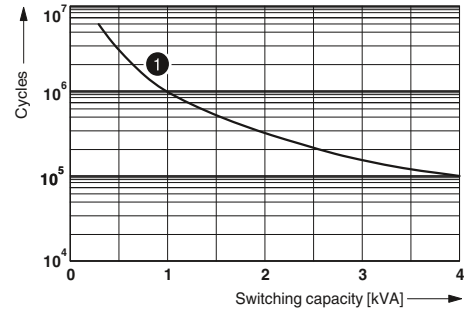

- 1 250 V AC, ohmic load

Service life reduction factor

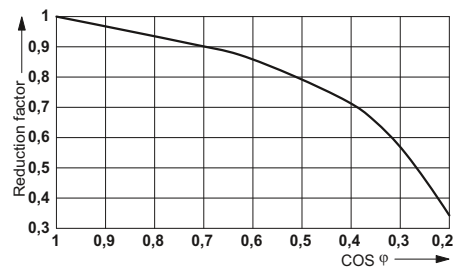

Relay modules

RIFLINE complete

Plug-in high-power relays

N

Plug-in high-power relays with 3 N/O contacts suitable for the RIF-4 relay base.

The advantages:

- Use in miniature contactor applications
- Switching current of up to 16 A
- Up to 440 V AC switching voltage
- Full shutdown by means of ≥ 3 mm contact opening



3 N/O relay

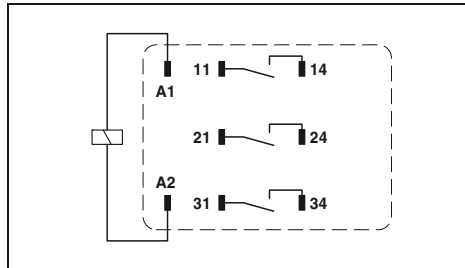

Technical data

	①	②	③	④
Input data	refer to the diagram			
Permissible range (with reference to U_N)				
Typ. input current at U_N	[mA]	70	116	23
Typ. response time at U_N	[ms]	20		
Typ. response time at U_N (depending on phase relation)	[ms]		5 - 25	5 - 25
Typ. release time at U_N	[ms]	15		
Typ. release time at U_N (depending on phase relation)	[ms]		5 - 20	5 - 20
Output data				
Contact type	Single contact, 3 N/O contacts			
Contact material	AgNi			
Max. switching voltage	440 V AC / 250 V DC			
Min. switching voltage	10 V (At 24 mA)			
Limiting continuous current	16 A			
Max. inrush current, AC	50 A (20 ms, N/O contact)			
Max. inrush current, DC	50 A (20 ms, N/O contact)			
Min. switching current	10 mA (at 24 V)			
Max. interrupting rating, ohmic load	250 V AC	4000 VA		
	440 V AC	4000 VA		
Motor load according to UL 508		1/3 HP, 120 V AC (single-phase AC motor)		
		1/2 HP, 240 V AC (single-phase AC motor)		
		1/2 HP, 240 V AC (three-phase induction motor)		
General data				
Test voltage (winding / contact)	2.5 kV _{rms} (50 Hz, 1 min.)			
Ambient temperature (operation), AC	-40°C ... 55°C			
Ambient temperature (operation), DC	-40°C ... 70°C			
Nominal operating mode	100% operating factor			
Mechanical service life, AC	Approx. 10 ⁷ cycles			
Mechanical service life, DC	Approx. 10 ⁷ cycles			
Standards/regulations	IEC 60664			
Mounting position/mounting	Any			
Dimensions	W / H / D	38.6 mm / 45.5 mm / 36.1 mm		

Ordering data

Description	Input voltage U_N	Type	Order No.	Pcs. / Pkt.
Plug-in high-power relays, 3 N/O contacts with power contacts				
	① 24 V DC	REL-PR3- 24DC/3X1	2903706	1
	② 24 V AC	REL-PR3- 24AC/3X1	2903707	1
	③ 120 V AC	REL-PR3-120AC/3X1	2903708	1
	④ 230 V AC	REL-PR3-230AC/3X1	2903709	1

REL-PR2... (3 N/O contacts)

Operating voltage range

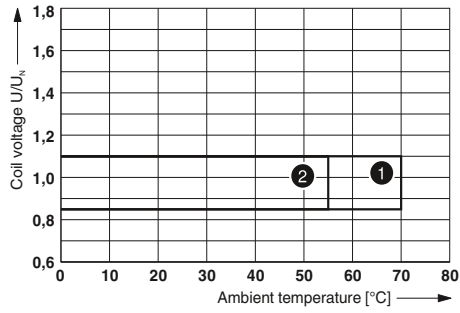

- ① DC coils
- ② AC coils

Interrupting rating

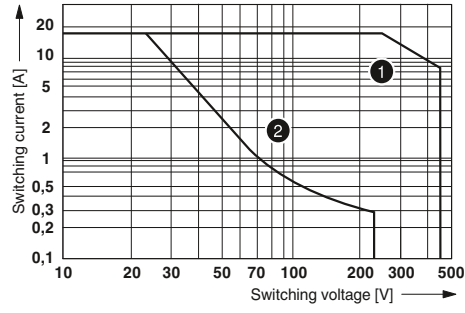

- ① AC, ohmic load
- ② DC, ohmic load

Electrical service life

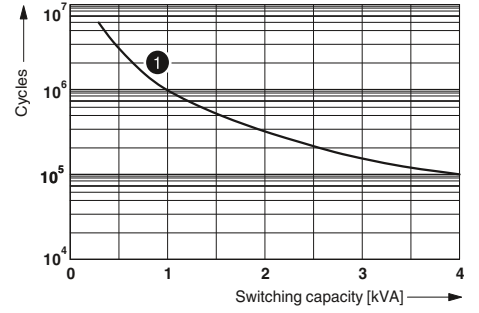

- ① 250 V AC, ohmic load

Service life reduction factor

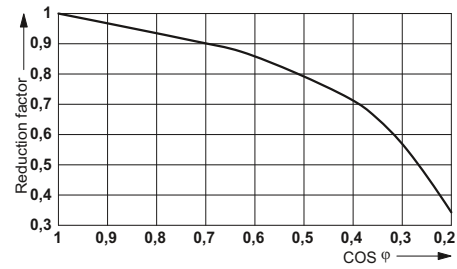

Input modules/interference suppression modules for RIF-1, RIF-2, RIF-3, and RIF-4

Plug-in input modules/interference suppression modules for optional fitting of RIF-1 to RIF-4 relay bases.

The advantages:

- Attenuation of reverse voltage induced in coil
- Mechanical coding to protect against incorrect connection

N



Input/interference suppression module

Description	Ordering data		
	Type	Order No.	Pcs. / Pkt.
Plug-in module , with LED status indicator and freewheeling diode to effectively limit the coil induction voltage, polarity: A1+ , A2- , input voltage: - 12-24 V DC $\pm 20\%$ - 48-60 V DC $\pm 20\%$ - 110 V DC $\pm 20\%$	RIF-LDP-12-24 DC RIF-LDP-48-60 DC RIF-LDP-110 DC	2900939 2900940 2900941	10 10 10
Plug-in module , with LED status indicator and varistor to limit the coil induction voltage and/or external interference peaks, input voltage: - 12-24 V AC/DC $\pm 20\%$ (30-V-varistor) - 48-60 V AC/DC $\pm 20\%$ (75-V-varistor) - 120-230 V AC/110 V DC $\pm 20\%$ (275-V-varistor)	RIF-LV-12-24 UC RIF-LV-48-60 UC RIF-LV-120-230 AC/110 DC	2900942 2900943 2900944	10 10 10
Plug-in module , with varistor to limit the coil induction voltage and/or external interference peaks, input voltage: - 12-24 V AC/DC $\pm 20\%$ (30-V-varistor) - 48-60 V AC/DC $\pm 20\%$ (75-V-varistor) - 120-230 V AC/110 V DC $\pm 20\%$ (275-V-varistor)	RIF-V-12-24 UC RIF-V-48-60 UC RIF-V-120-230 UC	2900945 2900947 2900948	10 10 10
Plug-in module , with RC element to limit the coil induction voltage and/or external interference peaks, input voltage: - 12-24 V AC/DC $\pm 20\%$ (220 nF/100 Ω) - 48-60 V AC/DC $\pm 20\%$ (220 nF/220 Ω) - 120 - 230 V AC/110 DC $\pm 20\%$ (100 nF/470 Ω)	RIF-RC-12-24 UC RIF-RC-48-60 UC RIF-RC-120-230 UC	2900949 2900950 2900951	10 10 10

Plug-in timer module for RIF-1, RIF-2, RIF-3, and RIF-4

The multifunctional plug-in timer module transforms the relay module into a timer relay. The RIF-1 to RIF-4 bases can be fitted with this module. Using DIP switches, you can choose from three time ranges and select four time functions. Fine adjustments to the time are made using a potentiometer. Relays can be operated with an input voltage of 24 V AC/DC.

Functions:

- Switch-on delay
- Single shot leading edge
- Flasher/pulse generator

Time ranges:

- 0.5 s - 10 s
- 5 s - 100 s
- 0.5 min - 10 min
- 5 min - 100 min



Time module

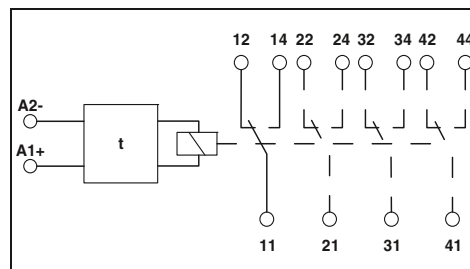

With switch-on delay

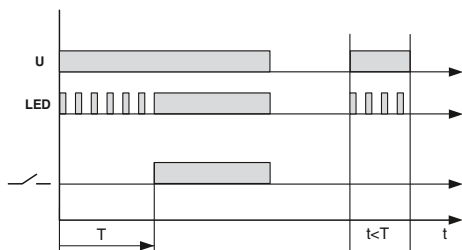

With passing make contact

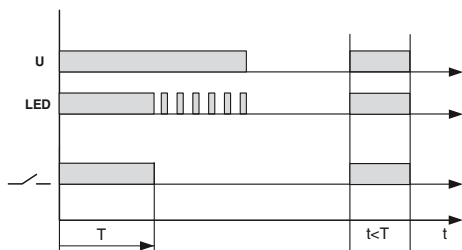

Flasher/pulse generator

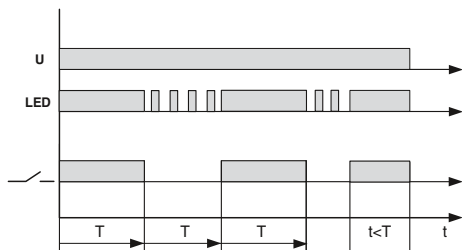

Input data
Nominal input voltage U_N
Nominal input voltage range with reference to U_N
Input circuit
Output data
Limiting continuous current
General data
Mounting position
Repeat accuracy
Ambient temperature (operation)
Standards/specifications
Rated insulation voltage
Rated surge voltage

Technical data
24 V DC (AC operation only permitted for RIF-1)
0.4 ... 1.2
Varistor, Yellow LED
≤ 250 mA (Relay coil current)
Any
1%
-25°C ... 50°C (RIF-1, AC coil, 2 PDTs at 6 A)
-25°C ... 50°C (RIF-1, DC coil, 2 PDTs at 5 A)
-25°C ... 40°C (RIF-2, DC coil, 2 PDTs at 8 A)
-25°C ... 40°C (RIF-2, DC coil, 4 PDTs at 5 A)
-25°C ... 40°C (RIF-3, DC coil, 3 PDTs at 6.75 A)
-25°C ... 40°C (RIF-3, DC coil, 2 PDTs at 8 A)
-25°C ... 35°C (RIF-4, DC coil, 3 PDTs at 8 A)
-25°C ... 25°C (RIF-4, DC coil, 3 N/O contacts at 8 A)
DIN EN 50178
50 V DC
0.4 kV

Description
Timer module , for mounting on RIF-1 to RIF-4, with LED status indicator for extending a relay module to create a timer relay with an input voltage of 24 V AC/DC

Ordering data		
Type	Order No.	Pcs. / Pkt.
RIF-T3-24UC	2902647	1

Relay modules

RIFLINE complete

Fully mounted RIF-0 relay modules

Fully mounted RIF-0 relay modules, consisting of:

- Relay base
- 1 N/O contact or 1 PDT relay
- Relay ejector lever on the housing

The advantages:

- Status LED integrated in the relay base
- Operational reliability thanks to sealed relay
- Safe isolation between coil and contact side
- Professional bridging of adjacent modules saves wiring time
- For FBS 2-6 plug-in bridges for the input and output side, see page 318.

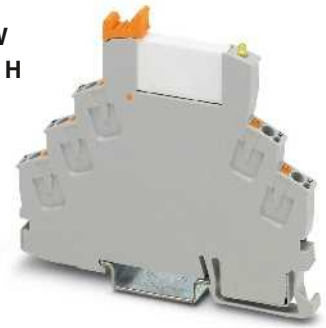

RIF-0 relay module with 1 PDT relay

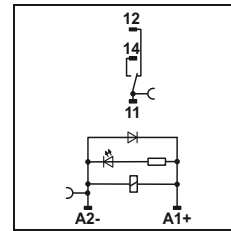

DC coils

Input data	
Permissible range (with reference to U_N)	
Typ. input current at U_N	[mA]
Typ. response time at U_N	[ms]
Typ. release time at U_N	[ms]
Input protection:	
Output data	
Contact type	
Contact material	
Max. switching voltage	
Min. switching voltage	
Limiting continuous current	
Min. switching current	
General data	
Test voltage (winding / contact)	
Ambient temperature (operation)	
Nominal operating mode	
Mechanical service life	
Standards/regulations	
Pollution degree/surge voltage category	
Mounting position/mounting	
Connection data solid / stranded / AWG	
Dimensions	W / H / D

Technical data		
①	②	
refer to the diagram		
16	9	
5	5	
8	8	
Yellow LED, Damping diode		
Single contact, 1-PDT	Single contact, 1-PDT	
AgSnO	AgSnO, hard gold-plated	
250 V AC/DC	30 V AC / 36 V DC	
5 V (at 100 mA)	100 mV (at 10 mA)	
6 A	50 mA	
10 mA (at 12 V)	1 mA	
4 kV_{rms} (50 Hz, 1 min.)		
-40°C ... 60°C		
100% operating factor		
Approx. 2×10^7 cycles		
DIN EN 50178, IEC 62103		
2 / III		
Any / In rows with zero spacing		
0.14 - 1.5 mm ² / 0.14 - 1.5 mm ² / 26 - 16		
6.2 mm / 78 mm / 93 mm		

Description	Input voltage U_N
Coupling relay modules with power contact relay	① 12 V DC
	② 24 V DC
Coupling relay modules with power contact relay and gold contacts	① 12 V DC
	② 24 V DC

Ordering data		
Type	Order No.	Pcs. / Pkt.
RIF-0-RPT-12DC/21	2903371	10
RIF-0-RPT-24DC/21	2903370	10
RIF-0-RPT-12DC/21AU	2903369	10
RIF-0-RPT-24DC/21AU	2903368	10

N RIF-0-RPT.../21... (1 PDT)

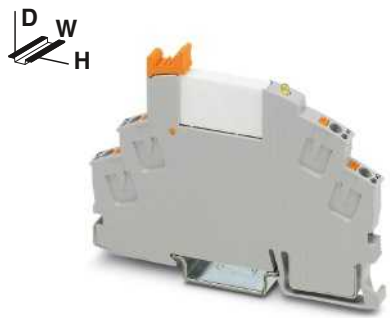

RIF-0 relay module with 1 N/O relay

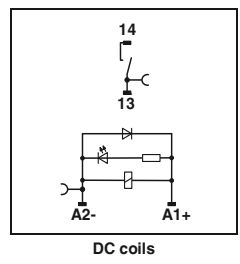

Technical data

①	②
refer to the diagram	
16	9
5	5
8	8
Yellow LED, Damping diode	

Single contact, 1 N/O contact	Single contact, 1 N/O contact
AgSnO	AgSnO, hard gold-plated
250 V AC/DC	30 V AC / 36 V DC
5 V (at 100 mA)	100 mV (at 10 mA)
6 A	50 mA
10 mA (at 12 V)	1 mA (at 12 V)

4 kV_{rms} (50 Hz, 1 min.)
 -40°C ... 60°C
 100% operating factor
 Approx. 2 x 10⁷ cycles
 DIN EN 50178, IEC 62103
 2 / III
 Any / In rows with zero spacing
 0.14 - 1.5 mm² / 0.14 - 1.5 mm² / 26 - 16
 6.2 mm / 78 mm / 93 mm

Ordering data

Type	Order No.	Pcs. / Pkt.
RIF-0-RPT-12DC/ 1	2903362	10
RIF-0-RPT-24DC/ 1	2903361	10
RIF-0-RPT-12DC/ 1AU	2903360	10
RIF-0-RPT-24DC/ 1AU	2903359	10

Operating voltage range

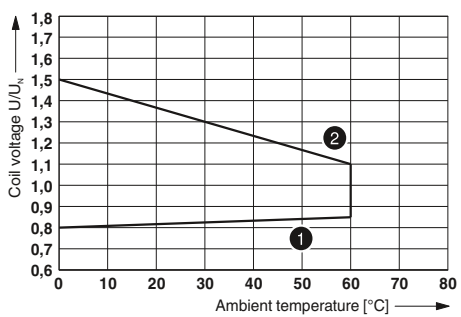

Service life reduction factor

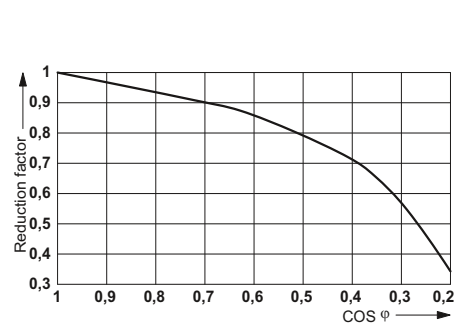

Interrupting rating

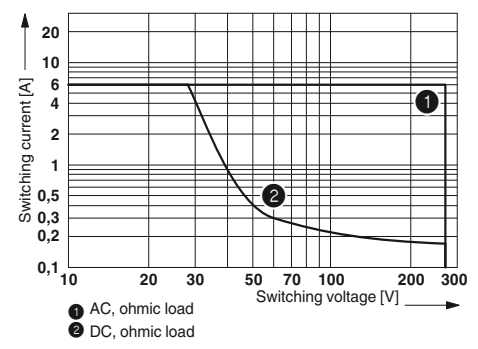

Electrical service life

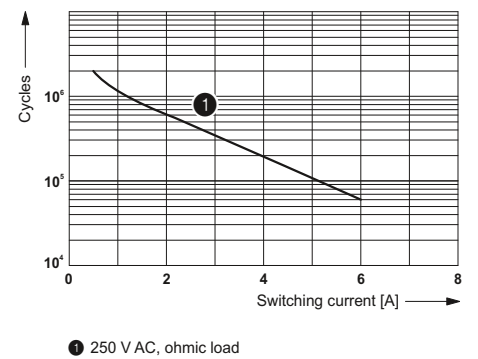

RIF-0-RPT.../1... (1 N/O contact)

Operating voltage range

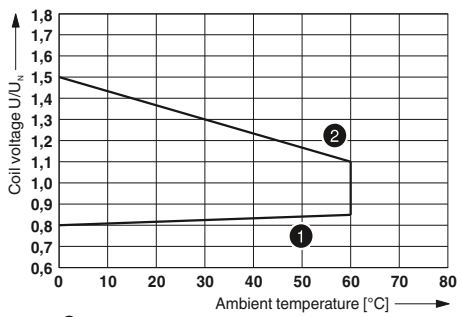

Service life reduction factor

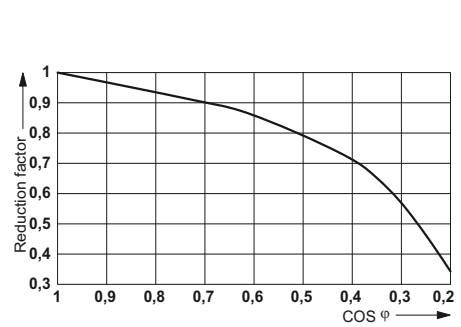

Interrupting rating

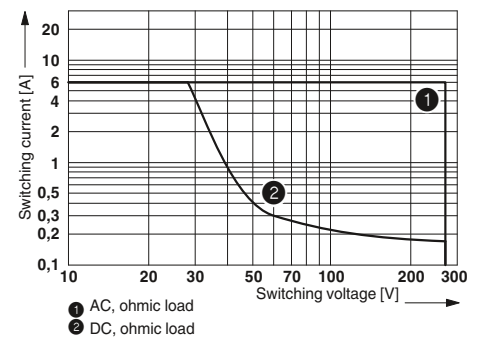

Electrical service life

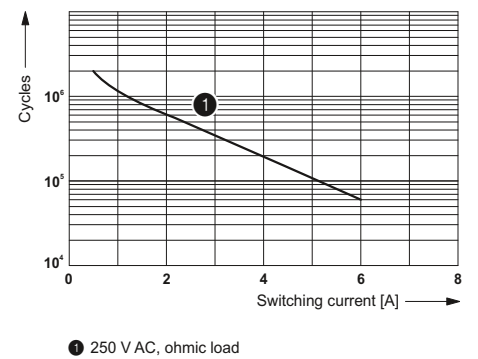

Fully mounted RIF-1 relay modules

Fully mounted RIF-1 relay modules, consisting of:

- 1 or 2 PDT relays
- Relay retaining bracket
- Input module/interference suppr. module

The advantages:

- Logical contact arrangement thanks to 1/3-level relay base
- Operational reliability thanks to sealed relay
- Safe isolation between coil and contact side
- Professional bridging of adjacent modules saves wiring time
- For FBS 2-6 plug-in bridges for the input side (A2), see page 318.
- For FBS 2-8 plug-in bridges for the output side (11/21), see page 318.

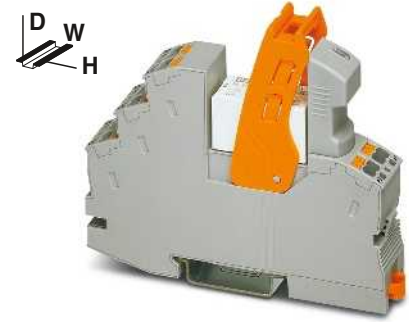

RIF-1 relay module with 1 PDT relay

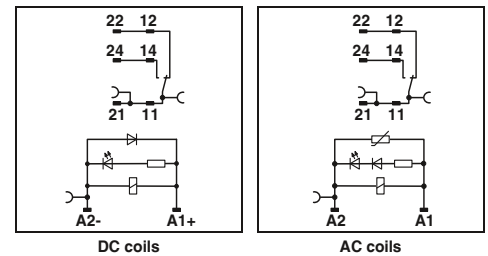

DC coils

AC coils

Technical data

Input data	①	②	③	④
Permissible range (with reference to U_N)	refer to the diagram			
Typ. input current at U_N [mA]	18	33	8	6
Typ. response time at U_N [ms]	8	3 - 12	3 - 12	3 - 12
Typ. release time at U_N [ms]	10	3 - 20	3 - 20	3 - 20
Input circuit AC	Yellow LED, Varistor			
Input circuit DC	Yellow LED, Damping diode, Polarity protection diode			
Output data	Single contact, 1-PDT		Single contact, 1-PDT	
Contact type				
Contact material	AgNi		AgNi, hard gold-plated	
Max. switching voltage	250 V AC/DC		30 V AC / 36 V DC	
Min. switching voltage	12 V (at 10 mA)		100 mV (at 10 mA)	
Limiting continuous current	(refer to the diagram)		50 mA	
Max. inrush current, AC	25 A (20 ms, N/O contact)		50 mA	
Max. inrush current, DC	50 A (20 ms, N/O contact)		50 mA	
Min. switching current	10 mA (at 12 V)		1 mA (at 24 V)	
General data	4 kV _{rms} (50 Hz, 1 min.)			
Test voltage (winding / contact)	-40°C ... 70°C			
Ambient temperature (operation), AC	-40°C ... 50°C			
Ambient temperature (operation), DC	100% operating factor			
Nominal operating mode	Approx. 10 ⁷ cycles			
Mechanical service life, AC	Approx. 3 x 10 ⁷ cycles			
Mechanical service life, DC	DIN EN 50178, IEC 62103			
Standards/regulations	2 / III			
Pollution degree/surge voltage category	Any / In rows with zero spacing			
Mounting position/mounting	0.14 - 1.5 mm ² / 0.14 - 1.5 mm ² / 26 - 16			
Connection data solid / stranded / AWG	16 mm / 75 mm / 93 mm			
Dimensions	W / H / D			

Ordering data

Description	Input voltage U_N	Type	Order No.	Pcs. / Pkt.
Coupling relay modules with power contact relay	① 24 V DC	RIF-1-RPT-LDP-24DC/1X21	2903342	10
	② 24 V AC	RIF-1-RPT-LV-24AC/1X21	2903341	10
	③ 120 V AC	RIF-1-RPT-LV-120AC/1X21	2903340	10
	④ 230 V AC	RIF-1-RPT-LV-230AC/1X21	2903339	10
Coupling relay modules with power contact relay and gold contacts	① 24 V DC	RIF-1-RPT-LDP-24DC/1X21AU	2903338	10
	② 24 V AC	RIF-1-RPT-LV-24AC/1X21AU	2903337	10
	③ 120 V AC	RIF-1-RPT-LV-120AC/1X21AU	2903336	10
	④ 230 V AC	RIF-1-RPT-LV-230AC/1X21AU	2903335	10

N RIF-1-RPT.../1X21... (1 PDT)

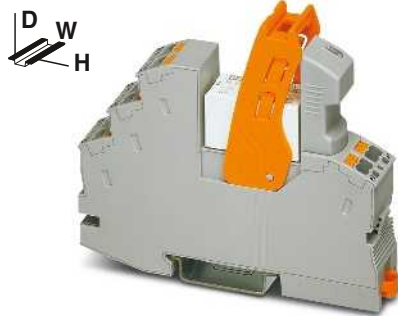

RIF-1 relay module with 2 PDT relay

Operating voltage range

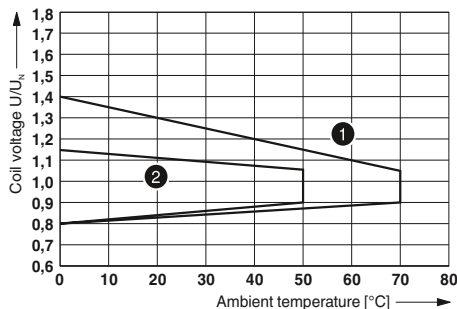

- 1 DC coils
- 2 AC coils

Interrupting rating

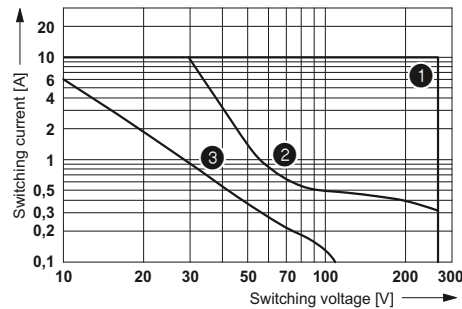

- 1 AC, ohmic load
- 2 DC, ohmic load
- 3 DC, L/R = 40 ms

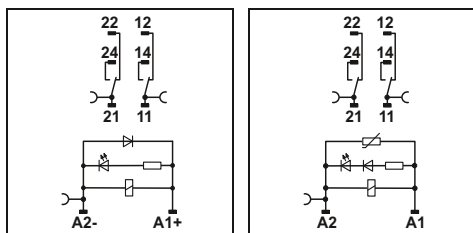

Contact derating

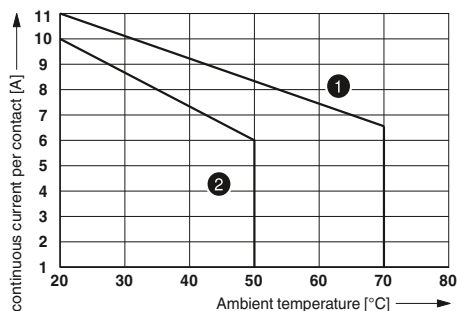

- 1 DC coil
- 2 AC coil

Electrical service life

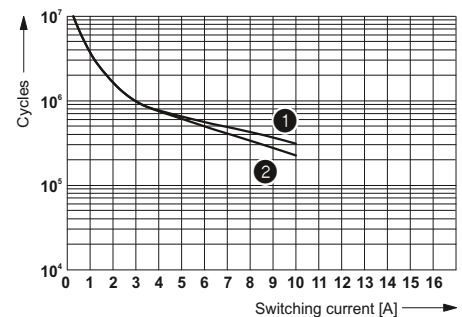

- 1 250 V AC, ohmic load (DC coils)
- 2 250 V AC, ohmic load (AC coils)

Technical data

①	②	③	④
refer to the diagram			
18	33	8	6
8	3 - 12	3 - 12	3 - 12
10	3 - 20	3 - 20	3 - 20
Yellow LED, Varistor			
Yellow LED, Damping diode, Polarity protection diode			

Single contact, 2-PDT Single contact, 2-PDT

AgNi	AgNi, hard gold-plated
250 V AC/DC	30 V AC / 36 V DC
5 V (at 10 mA)	100 mV (at 10 mA)
8 A (refer to the diagram)	50 mA
12 A (20 ms, N/O contact)	50 mA
25 A (20 ms, N/O contact)	50 mA
10 mA (at 5 V)	1 mA (at 24 V)

- 4 kV_{ms} (50 Hz, 1 min.)
- 40°C ... 70°C
- 40°C ... 50°C
- 100% operating factor
- Approx. 10⁷ cycles
- Approx. 3 x 10⁷ cycles
- DIN EN 50178, IEC 62103
- 2 / III
- Any / In rows with zero spacing
- 0.14 - 1.5 mm² / 0.14 - 1.5 mm² / 26 - 16
- 16 mm / 75 mm / 93 mm

Ordering data

Type	Order No.	Pcs. / Pkt.
RIF-1-RPT-LDP-24DC/2X21	2903334	10
RIF-1-RPT-LV-24AC/2X21	2903333	10
RIF-1-RPT-LV-120AC/2X21	2903332	10
RIF-1-RPT-LV-230AC/2X21	2903331	10
RIF-1-RPT-LDP-24DC/2X21AU	2903330	10
RIF-1-RPT-LV-24AC/2X21AU	2903329	10
RIF-1-RPT-LV-120AC/2X21AU	2903328	10
RIF-1-RPT-LV-230AC/2X21AU	2903327	10

RIF-1-RPT.../2X21... (2 PDTs)

Operating voltage range

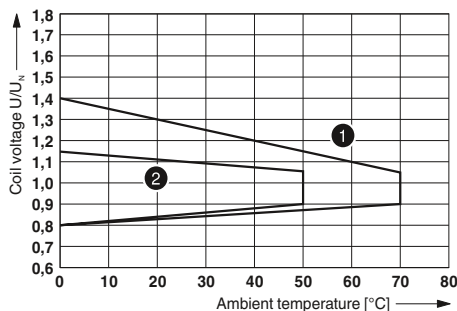

- 1 DC coils
- 2 AC coils

Interrupting rating

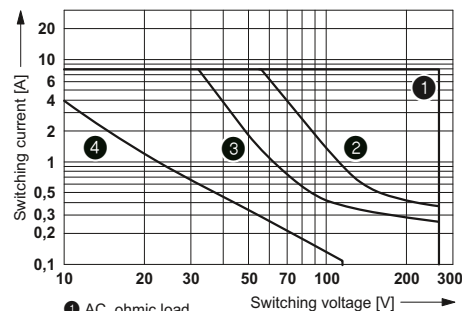

- 1 AC, ohmic load
- 2 DC, ohmic load, contacts in series
- 3 DC, ohmic load
- 4 DC, L/R = 40 ms

Contact derating

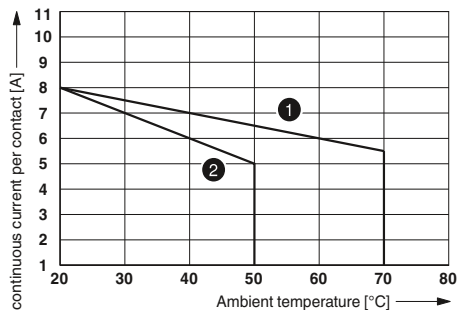

- 1 DC coil
- 2 AC coil

Electrical service life

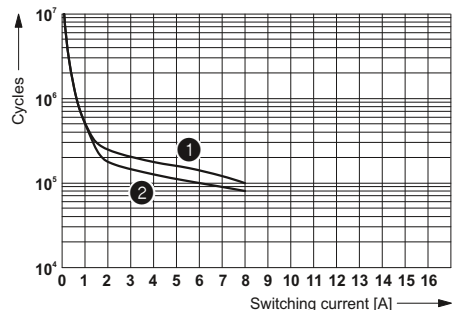

- 1 250 V AC, ohmic load (DC coils)
- 2 250 V AC, ohmic load (AC coils)

Fully mounted RIF-2 relay modules

Fully mounted RIF-2 relay modules, consisting of:

- 1 or 2 PDT relays
- Relay retaining bracket
- Input module/interference suppr. module (AC types only)

The advantages:

- Relay with lockable manual operation and status LED
- With DC types, freewheeling diode is integrated into relay
- Mechanical switch position indicator
- Logical contact arrangement thanks to 1/3-level relay base
- Professional bridging of adjacent modules saves wiring time
- For FBS 2-6 plug-in bridges for the input side (A2), see page 318.



N



RIF-2 relay module with 2 PDT relay

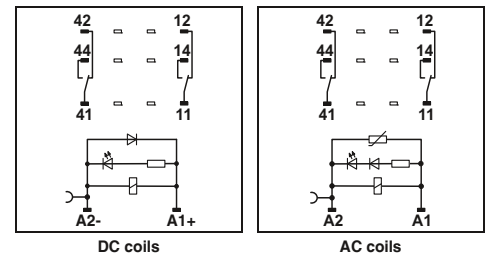

DC coils

AC coils

Technical data

	①	②	③	④
Input data	refer to the diagram			
Permissible range (with reference to U_N)				
Typ. input current at U_N	41	70	13	6.5
Typ. response time at U_N	13	5 - 15	5 - 15	5 - 15
Typ. release time at U_N	14	5 - 20	5 - 20	5 - 20
Input circuit AC	Yellow LED, Varistor			
Input circuit DC	Yellow LED, Damping diode			
Output data				
Contact type	Single contact, 2-PDT			
Contact material	AgNi			
Max. switching voltage	250 V AC/DC			
Min. switching voltage	5 V (At 24 mA)			
Limiting continuous current	(refer to the diagram)			
Max. inrush current, AC	30 A (20 ms, N/O contact)			
Max. inrush current, DC	30 A (20 ms, N/O contact)			
Min. switching current	5 mA (at 24 V)			
General data				
Test voltage (winding / contact)	2.5 kV _{rms} (50 Hz, 1 min.)			
Ambient temperature (operation), AC	-40°C ... 50°C			
Ambient temperature (operation), DC	-40°C ... 60°C			
Nominal operating mode	100% operating factor			
Mechanical service life, AC	Approx. 2 x 10 ⁷ cycles			
Mechanical service life, DC	Approx. 2 x 10 ⁷ cycles			
Standards/regulations	DIN EN 50178, IEC 62103			
Pollution degree/surge voltage category	2 / III			
Mounting position/mounting	Any / In rows with zero spacing			
Connection data solid / stranded / AWG	0.14 - 1.5 mm ² / 0.14 - 1.5 mm ² / 26 - 16			
Dimensions	W / H / D 31 mm / 75 mm / 93 mm			

Ordering data

Description	Input voltage U_N	Type	Order No.	Pcs. / Pkt.
Pre-assembled coupling relay modules with miniature power contact relay	① 24 V DC	RIF-2-RPT-LDP-24DC/2X21	2903315	10
	② 24 V AC	RIF-2-RPT-LV-24AC/2X21	2903313	10
	③ 120 V AC	RIF-2-RPT-LV-120AC/2X21	2903311	10
	④ 230 V AC	RIF-2-RPT-LV-230AC/2X21	2903310	10

N RIF-2-RPT.../2X21 (2 PDTs)



RIF-2 relay module with 4 PDT relay

Operating voltage range

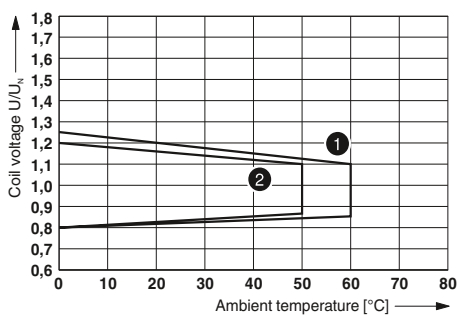

- 1 DC coil (observe contact derating)
- 2 AC coil (observe contact derating)

Interrupting rating

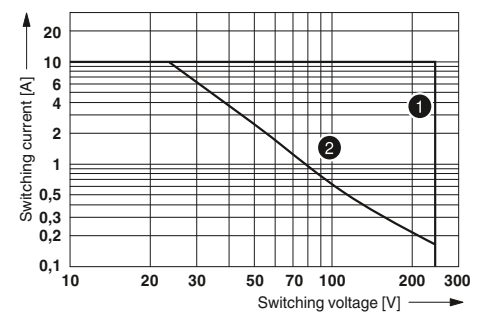

- 1 AC, ohmic load
- 2 DC, ohmic load

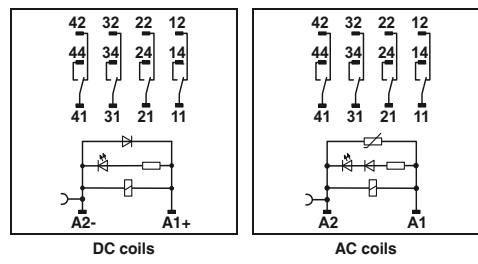

Contact derating

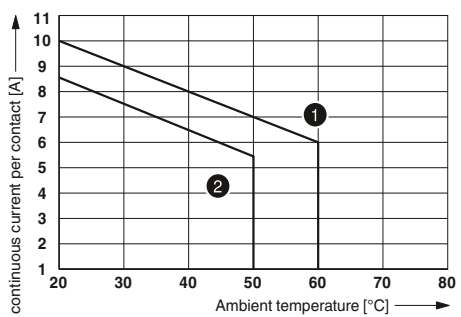

- 1 DC coil
- 2 AC coil

Electrical service life

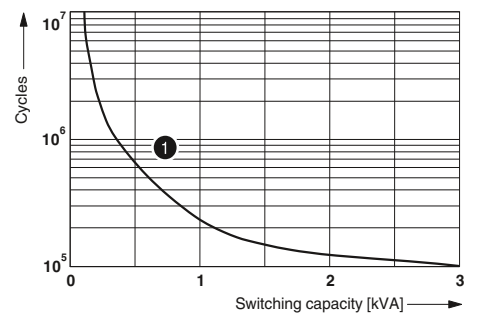

- 1 250 V AC, ohmic load

Technical data

①	②	③	④
refer to the diagram			
41	70	13	6.5
13	5 - 15	5 - 15	5 - 15
14	5 - 20	5 - 20	5 - 20
Yellow LED, Varistor			
Yellow LED, Damping diode			

Single contact, 4-PDT
 AgNi
 250 V AC/DC
 5 V (At 24 mA)
 (refer to the diagram)
 16 A (20 ms, N/O contact)
 16 A (20 ms, N/O contact)
 5 mA (at 24 V)

2.5 kV_{rms} (50 Hz, 1 min.)
 -40°C ... 50°C
 -40°C ... 60°C
 100% operating factor
 Approx. 2 x 10⁷ cycles
 Approx. 2 x 10⁷ cycles
 DIN EN 50178, IEC 62103
 2 / II
 Any / In rows with zero spacing
 0.14 - 1.5 mm² / 0.14 - 1.5 mm² / 26 - 16
 31 mm / 75 mm / 93 mm

Ordering data

Type	Order No.	Pcs. / Pkt.
RIF-2-RPT-LDP-24DC/4X21	2903308	10
RIF-2-RPT-LV-24AC/4X21	2903306	10
RIF-2-RPT-LV-120AC/4X21	2903305	10
RIF-2-RPT-LV-230AC/4X21	2903304	10

RIF-2-RPT.../4X21 (4 PDTs)

Operating voltage range

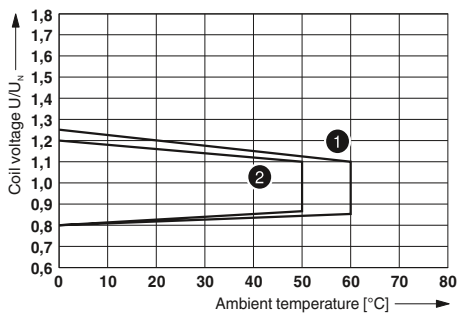

- 1 DC coil (observe contact derating)
- 2 AC coil (observe contact derating)

Interrupting rating

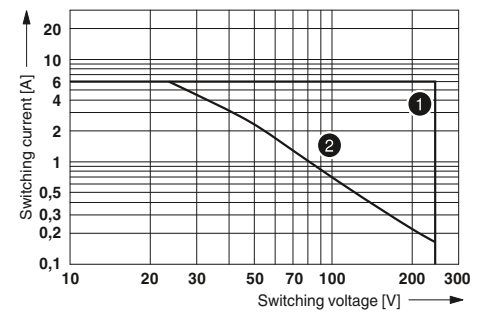

- 1 AC, ohmic load
- 2 DC, ohmic load

Contact derating

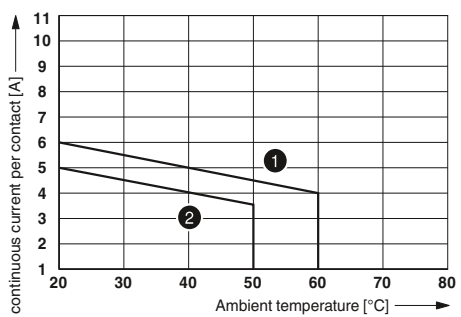

- 1 DC coil
- 2 AC coil

Electrical service life

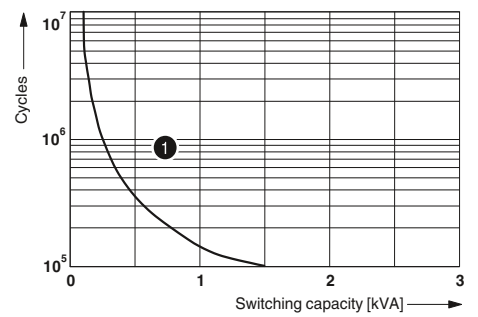

- 1 250 V AC, ohmic load

Fully mounted RIF-3 relay modules

Fully mounted RIF-3 relay modules, consisting of:

- Relay base
- 2 or 3 PDT relays
- Relay retaining bracket
- Input module/interference suppr. module (AC types only)

The advantages:

- Relay with lockable manual operation and status LED
- With DC types, freewheeling diode is integrated into relay
- Mechanical switch position indicator
- Logical contact arrangement thanks to 1/3-level relay base
- Professional bridging of adjacent modules saves wiring time
- For FBS 2-6 plug-in bridges for the input side (A2), see page 318.



RIF-3 relay module with 2 PDT relay

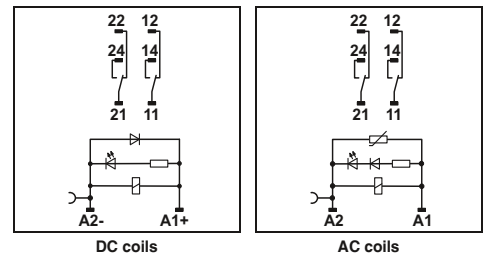

DC coils

AC coils

Technical data

Input data	①	②	③
Permissible range (with reference to U_N)	refer to the diagram		
Typ. input current at U_N	[mA]	60	23 13
Typ. response time at U_N	[ms]	18	5 - 15 5 - 15
Typ. release time at U_N	[ms]	20	5 - 20 5 - 20
Input circuit AC	Yellow LED, Varistor		
Input circuit DC	Yellow LED, Damping diode		
Output data			
Contact type	Single contact, 2-PDT		
Contact material	AgNi		
Max. switching voltage	250 V AC/DC		
Min. switching voltage	10 V (At 24 mA)		
Limiting continuous current	(refer to the diagram)		
Max. inrush current, AC	30 A (20 ms, N/O contact)		
Max. inrush current, DC	30 A (20 ms, N/O contact)		
Min. switching current	10 mA (at 24 V)		
General data			
Test voltage (winding / contact)	2.5 kV _{rms} (50 Hz, 1 min.)		
Ambient temperature (operation), AC	-40°C ... 50°C		
Ambient temperature (operation), DC	-40°C ... 60°C		
Nominal operating mode	100% operating factor		
Mechanical service life, AC	Approx. 2 x 10 ⁷ cycles		
Mechanical service life, DC	Approx. 2 x 10 ⁷ cycles		
Standards/regulations	DIN EN 50178, IEC 62103		
Pollution degree/surge voltage category	2 / III		
Mounting position/mounting	Any / In rows with zero spacing		
Connection data solid / stranded / AWG	0.14 - 1.5 mm ² / 0.14 - 1.5 mm ² / 26 - 16		
Dimensions	W / H / D 40 mm / 90 mm / 100 mm		

Ordering data

Description	Input voltage U_N	Type	Order No.	Pcs. / Pkt.
Pre-assembled coupling relay modules with miniature power contact relay	① 24 V DC	RIF-3-RPT-LDP-24DC/2X21	2903297	5
	② 120 V AC	RIF-3-RPT-LV-120AC/2X21	2903296	5
	③ 230 V AC	RIF-3-RPT-LV-230AC/2X21	2903295	5

N

RIF-3-RPT.../2X21 (2 PDTs)



RIF-3 relay module with 3 PDT relay

Operating voltage range

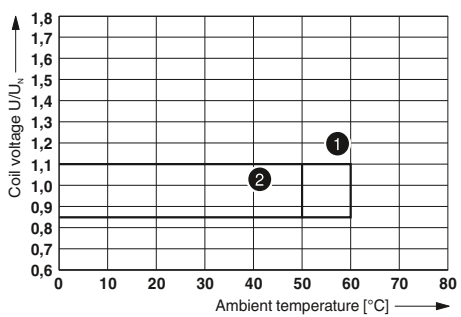

- ① DC coil (observe contact derating)
- ② AC coil (observe contact derating)

Interrupting rating

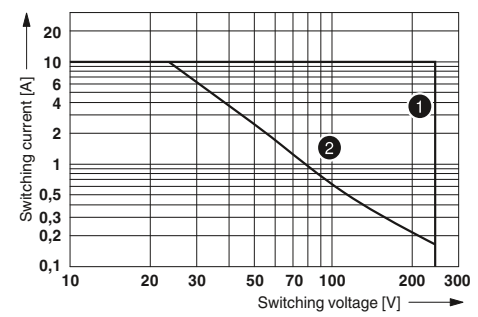

- ① AC, ohmic load
- ② DC, ohmic load

Contact derating

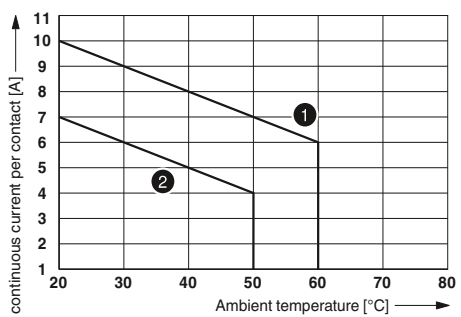

- ① DC coil
- ② AC coil

Electrical service life

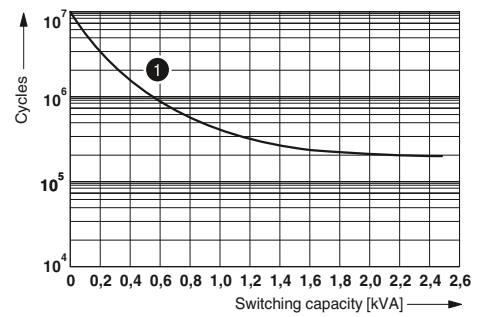

- ① 250 V AC, ohmic load

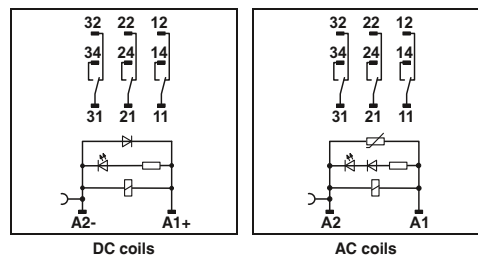

Technical data

- ① refer to the diagram
- ② 60
- ③ 23
- 18
- 20
- Yellow LED, Varistor
- Yellow LED, Damping diode

Single contact, three PDTs
 AgNi
 250 V AC/DC
 10 V (At 24 mA)
 (refer to the diagram)
 30 A (20 ms, N/O contact)
 30 A (20 ms, N/O contact)
 10 mA (at 24 V)

2.5 kV_{rms} (50 Hz, 1 min.)
 -40°C ... 50°C
 -40°C ... 60°C
 100% operating factor
 Approx. 2 x 10⁷ cycles
 Approx. 2 x 10⁷ cycles
 DIN EN 50178, IEC 62103
 2 / III
 Any / In rows with zero spacing
 0.14 - 1.5 mm² / 0.14 - 1.5 mm² / 26 - 16
 40 mm / 90 mm / 100 mm

Ordering data

Type	Order No.	Pcs. / Pkt.
RIF-3-RPT-LDP-24DC/3X21	2903294	5
RIF-3-RPT-LV-120AC/3X21	2903293	5
RIF-3-RPT-LV-230AC/3X21	2903292	5

RIF-3-RPT.../3X21 (3 PDTs)

Operating voltage range

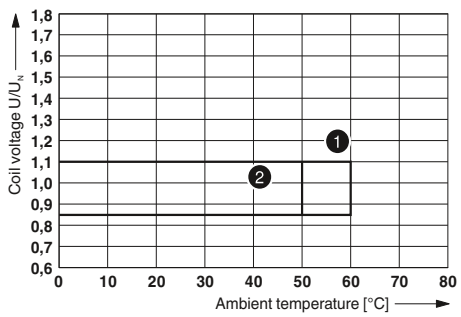

- ① DC coil (observe contact derating)
- ② AC coil (observe contact derating)

Interrupting rating

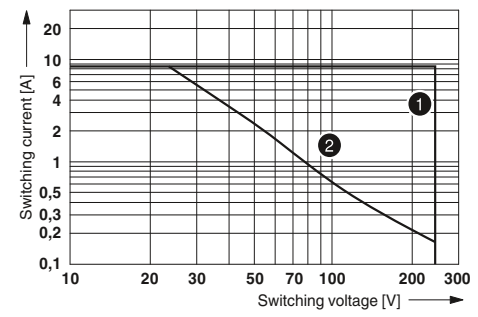

- ① AC, ohmic load
- ② DC, ohmic load

Contact derating

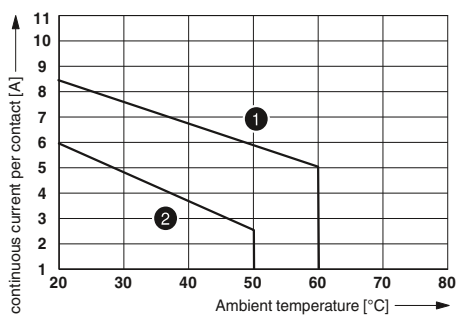

- ① DC coil
- ② AC coil

Electrical service life

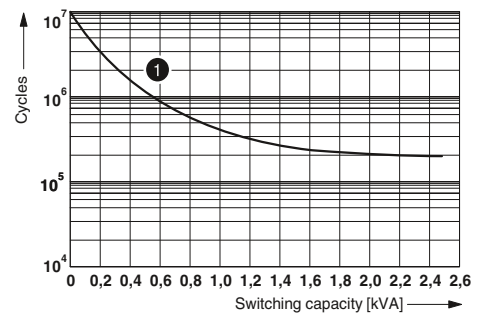

- ① 250 V AC, ohmic load

Relay modules

RIFLINE complete

Fully mounted RIF-4 relay modules

Fully mounted RIF-4 relay modules, consisting of:

- Relay base
- 2 or 3 PDT relays
- Relay retaining bracket
- Input module/interference suppr. module

The advantages:

- Logical contact arrangement thanks to 1/3-level relay base
- Professional bridging of adjacent modules saves wiring time
- For FBS 2-6 plug-in bridges for the input side (A2), see page 318.



RIF-4 relay module with 2 PDT relay

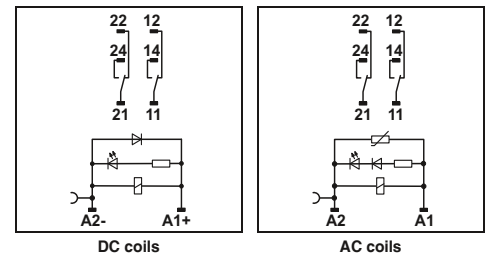

DC coils

AC coils

Technical data

Input data	①	②	③
Permissible range (with reference to U_N)	refer to the diagram		
Typ. input current at U_N [mA]	56	24	14
Typ. response time at U_N [ms]	20	5 - 25	5 - 25
Typ. release time at U_N [ms]	20	5 - 20	5 - 20
Input circuit AC	Yellow LED, Varistor		
Input circuit DC	Yellow LED, Damping diode, Polarity protection diode		
Output data			
Contact type	Single contact, 2-PDT		
Contact material	AgNi		
Max. switching voltage	440 V AC / 250 V DC		
Min. switching voltage	10 V (At 24 mA)		
Limiting continuous current	(refer to the diagram)		
Max. inrush current, AC	50 A (20 ms, N/O contact)		
Max. inrush current, DC	50 A (20 ms, N/O contact)		
Min. switching current	10 mA (at 24 V)		
Max. interrupting rating, ohmic load	250 V AC	2500 VA	
	440 V AC	4000 VA	
Motor load according to UL 508		1/3 HP, 120 V AC (single-phase AC motor)	
		1/2 HP, 240 V AC (single-phase AC motor)	
General data			
Test voltage (winding / contact)	2.5 kV _{rms} (50 Hz, 1 min.)		
Ambient temperature (operation), AC	-40°C ... 40°C		
Ambient temperature (operation), DC	-40°C ... 60°C		
Nominal operating mode	100% operating factor		
Mechanical service life, AC	Approx. 10 ⁷ cycles		
Mechanical service life, DC	Approx. 10 ⁷ cycles		
Standards/regulations	DIN EN 50178, IEC 62103		
Pollution degree/surge voltage category	2 / III		
Mounting position/mounting	Any / In rows with zero spacing		
Connection data solid / stranded / AWG			
Input side	0.14 ... 1.5 mm ² / 0.14 ... 1.5 mm ² / 26 - 16		
Output side	0.14 ... 2.5 mm ² / 0.14 ... 2.5 mm ² / 26 - 14		
Dimensions	W / H / D 43 mm / 90 mm / 107 mm		

Ordering data

Description	Input voltage U_N	Type	Order No.	Pcs. / Pkt.
Pre-assembled coupling relay modules with miniature power contact relay	① 24 V DC	RIF-4-RPT-LDP-24DC/2X21	2903281	5
	② 120 V AC	RIF-4-RPT-LV-120AC/2X21	2903280	5
	③ 230 V AC	RIF-4-RPT-LV-230AC/2X21	2903279	5



RIF-4 relay module with 3 PDT relay

N RIF-4-RPT.../2X21 (2 PDTs)

Operating voltage range

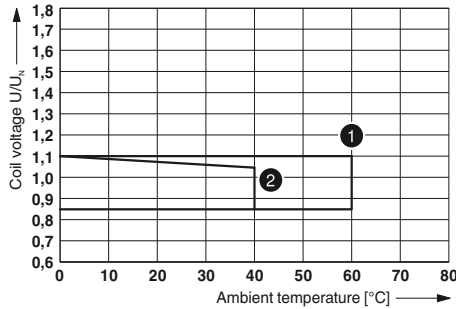

- ① DC coil (observe contact derating)
- ② AC coil (observe contact derating)

Interrupting rating

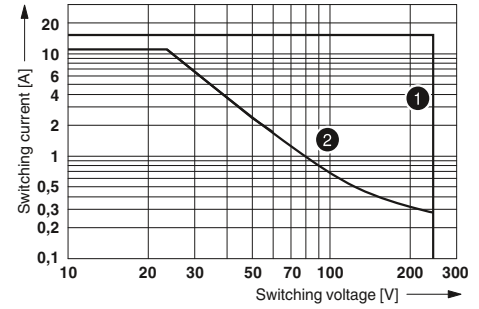

- ① AC, ohmic load
- ② DC, ohmic load

Contact derating

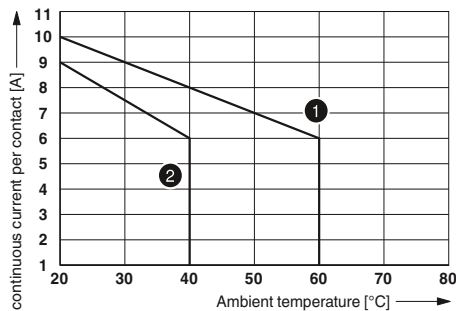

- ① DC coil
- ② AC coil

Electrical service life

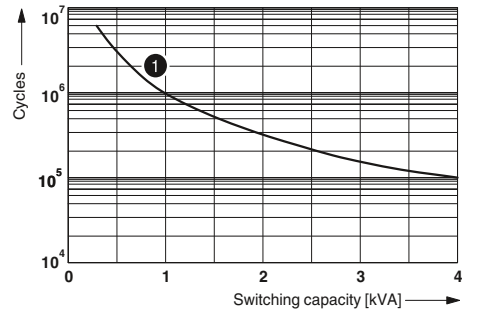

- ① 250 V AC, ohmic load

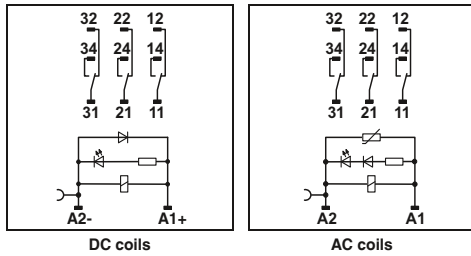

Technical data

- ① refer to the diagram
- ② 56
- ③ 14
- 20 5 - 25 5 - 25
- 20 5 - 20 5 - 20
- Yellow LED, Varistor
- Yellow LED, Damping diode, Polarity protection diode

Single contact, three PDTs
 AgNi
 440 V AC / 250 V DC
 10 V (At 24 mA)
 (refer to the diagram)
 50 A (20 ms, N/O contact)
 50 A (20 ms, N/O contact)
 10 mA (at 24 V)

2500 VA
 4000 VA
 1/3 HP, 120 V AC (single-phase AC motor)
 1/2 HP, 240 V AC (single-phase AC motor)
 1/2 HP, 240 V AC (three-phase induction motor)

2.5 kV_{rms} (50 Hz, 1 min.)
 -40°C ... 40°C
 -40°C ... 60°C
 100% operating factor
 Approx. 10⁷ cycles
 Approx. 10⁷ cycles
 DIN EN 50178, IEC 62103
 2 / III
 Any / In rows with zero spacing

0.14 ... 1.5 mm² / 0.14 ... 1.5 mm² / 26 - 16
 0.14 ... 2.5 mm² / 0.14 ... 2.5 mm² / 26 - 14
 43 mm / 90 mm / 107 mm

Ordering data

Type	Order No.	Pcs. / Pkt.
RIF-4-RPT-LDP-24DC/3X21	2903278	5
RIF-4-RPT-LV-120AC/3X21	2903277	5
RIF-4-RPT-LV-230AC/3X21	2903276	5

RIF-4-RPT.../3X21 (3 PDTs)

Operating voltage range

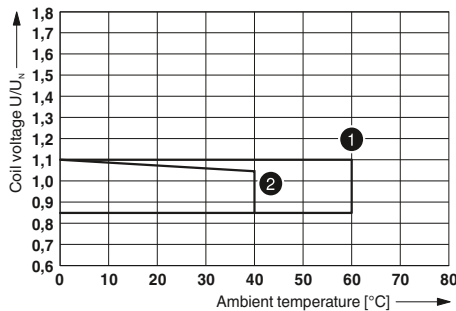

- ① DC coil (observe contact derating)
- ② AC coil (observe contact derating)

Interrupting rating

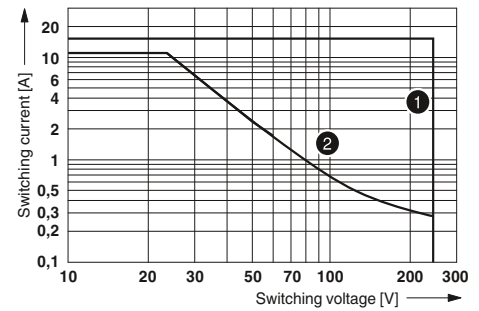

- ① AC, ohmic load
- ② DC, ohmic load

Contact derating

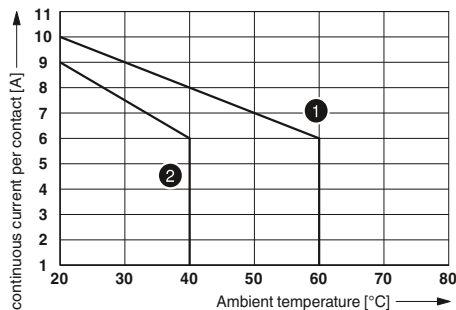

- ① DC coil
- ② AC coil

Electrical service life

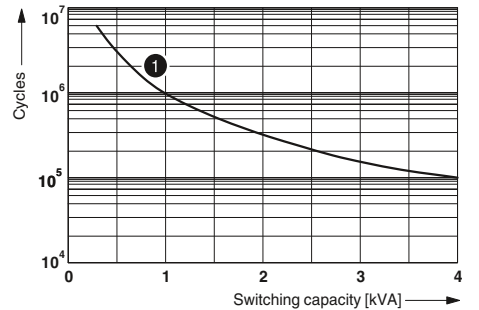

- ① 250 V AC, ohmic load

Fully mounted RIF-4 relay modules

Fully mounted RIF-4 relay modules, consisting of:

- Relay base
- 3 N/O relays
- Relay retaining bracket
- Input module/interference suppr. module

The advantages:

- Logical contact arrangement thanks to 1/3-level relay base
- Full shutdown by means of ≥ 3 mm contact opening
- Professional bridging of adjacent modules saves wiring time
- For FBS 2-6 plug-in bridges for the input side (A2), see page 318.

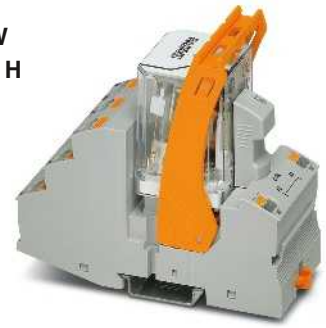

RIF-4 relay module with 3 N/O relay

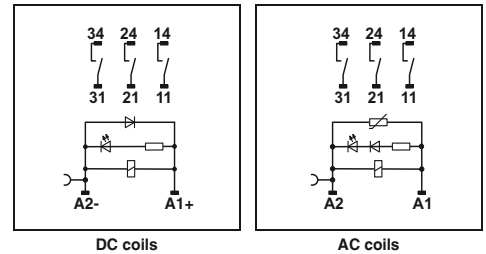

DC coils

AC coils

Technical data

Input data	①	②	③
Permissible range (with reference to U_N)	refer to the diagram		
Typ. input current at U_N [mA]	70	24	14
Typ. response time at U_N [ms]	20	5 - 25	5 - 25
Typ. release time at U_N [ms]	20	5 - 20	5 - 20
Input circuit AC	Yellow LED, Varistor		
Input circuit DC	Yellow LED, Damping diode, Polarity protection diode		
Output data			
Contact type	Single contact, 3 N/O contacts		
Contact material	AgNi		
Max. switching voltage	440 V AC / 250 V DC		
Min. switching voltage	10 V (At 24 mA)		
Limiting continuous current	(refer to the diagram)		
Max. inrush current, AC	50 A (20 ms, N/O contact)		
Max. inrush current, DC	50 A (20 ms, N/O contact)		
Min. switching current	10 mA (at 24 V)		
Max. interrupting rating, ohmic load	250 V AC	2500 VA	
	440 V AC	4000 VA	
Motor load according to UL 508		1/3 HP, 120 V AC (single-phase AC motor)	
		1/2 HP, 240 V AC (single-phase AC motor)	
		1/2 HP, 240 V AC (three-phase induction motor)	
General data			
Test voltage (winding / contact)	2.5 kV _{rms} (50 Hz, 1 min.)		
Ambient temperature (operation), AC	-40°C ... 40°C		
Ambient temperature (operation), DC	-40°C ... 60°C		
Nominal operating mode	100% operating factor		
Mechanical service life, AC	Approx. 10 ⁷ cycles		
Mechanical service life, DC	Approx. 10 ⁷ cycles		
Standards/regulations	DIN EN 50178, IEC 62103		
Pollution degree/surge voltage category	2 / III		
Mounting position/mounting	Any / In rows with zero spacing		
Connection data solid / stranded / AWG			
Input side	0.14 ... 1.5 mm ² / 0.14 ... 1.5 mm ² / 26 - 16		
Output side	0.14 ... 2.5 mm ² / 0.14 ... 2.5 mm ² / 26 - 14		
Dimensions	W / H / D 43 mm / 90 mm / 107 mm		

Ordering data

Description	Input voltage U_N	Type	Order No.	Pcs. / Pkt.
Pre-assembled coupling relay modules with miniature power contact relay	① 24 V DC	RIF-4-RPT-LDP-24DC/3X1	2903275	5
	② 120 V AC	RIF-4-RPT-LV-120AC/3X1	2903274	5
	③ 230 V AC	RIF-4-RPT-LV-230AC/3X1	2903273	5

N RIF-4-RPT.../3X1 (3 N/O contacts)

Operating voltage range

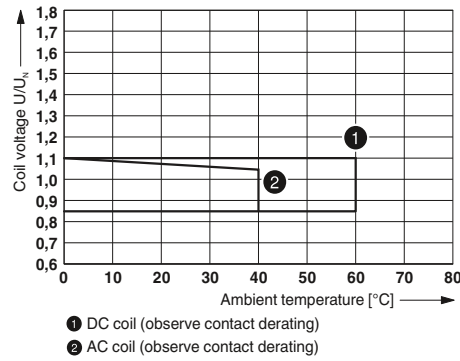

Interrupting rating

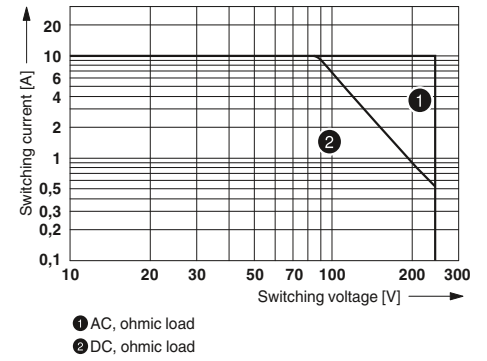

Contact derating

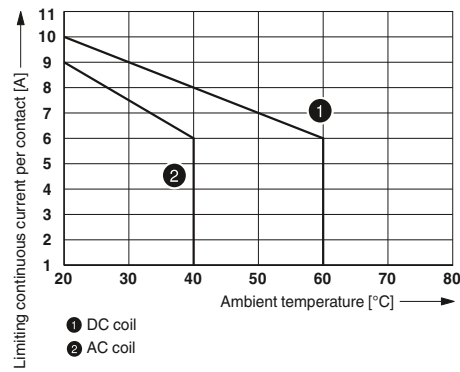

Electrical service life

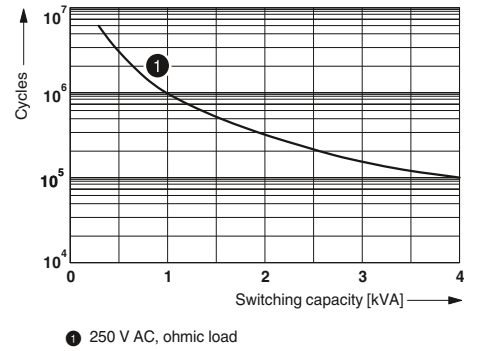

Relay modules

RIFLINE complete

RIFLINE complete accessories Plug-in bridges

The plug-in bridges can be used for simple potential distribution via all relay bases.

The end clamp is used for safe isolation between adjacent modules and to visually separate the various function groups.



Description	Color	Ordering data			Ordering data		
		Type	Order No.	Pcs. / Pkt.	Type	Order No.	Pcs. / Pkt.
Plug-in bridge							
2-pos. red		FBS 2-6	3030336	50			
2-pos. blue		FBS 2-6 BU	3036932	50			
2-pos. gray		FBS 2-6 GY	3032237	50			
5-pos. red		FBS 5-6	3030349	50			
10-pos. red		FBS 10-6	3030271	10			
20-pos. red		FBS 20-6	3030365	10			
50-pos. red		FBS 50-6	3032224	10			
2-pos. red		FBS 2-8	3030284	10			
2-pos. blue		FBS 2-8 BU	3032567	10			
2-pos. gray		FBS 2-8 GY	3032541	10			
End clamp , to snap on NS 35, 9.5 mm wide, can be labeled with ZB 6, ZB 8/27, KLM...		7042			CLIPFIX 35	3022218	50

RIFLINE complete accessories Marking material

The ZB zack marker strip system offers numerous marking options that can be attached directly to the relay retaining brackets. In addition, further markings can be fixed to the relay base by means of double marker carriers.

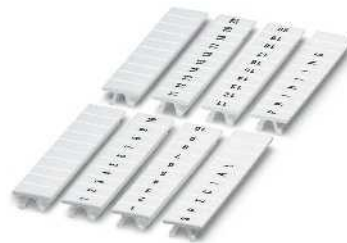

5.2 mm, 6.2 mm, and 15.2 mm wide



Double marker carrier

Description	Color	Ordering data			Ordering data		
		Type	Order No.	Pcs. / Pkt.	Type	Order No.	Pcs. / Pkt.
Zack marker strip, unprinted							
10-section	white	ZB 5 :UNBEDRUCKT	1050004	10			
10-section	white	ZB 6:UNBEDRUCKT	1051003	10			
5-section	white	ZB 15:UNBEDRUCKT	0811972	10			
Double marker carrier for ZB 5	gray				STP 5-2	0800967	100

RIFLINE complete accessories

Test plugs

The two-piece test plug offers individual plug color combinations. The test plug is inserted directly in the function shaft of the push-in connection.



		Ordering data		
Description	Color	Type	Order No.	Pcs. / Pkt.
Test plug, consisting of:				
Metal part for 2.3 mm Ø socket hole and		MPS-MT	0201744	10
Insulating sleeve , for MPS metal part	red	MPS-IH RD	0201676	10
	white	MPS-IH WH	0201663	10
	blue	MPS-IH BU	0201689	10
	yellow	MPS-IH YE	0201692	10
	green	MPS-IH GN	0201702	10
	gray	MPS-IH GY	0201728	10
	black	MPS-IH BK	0201731	10

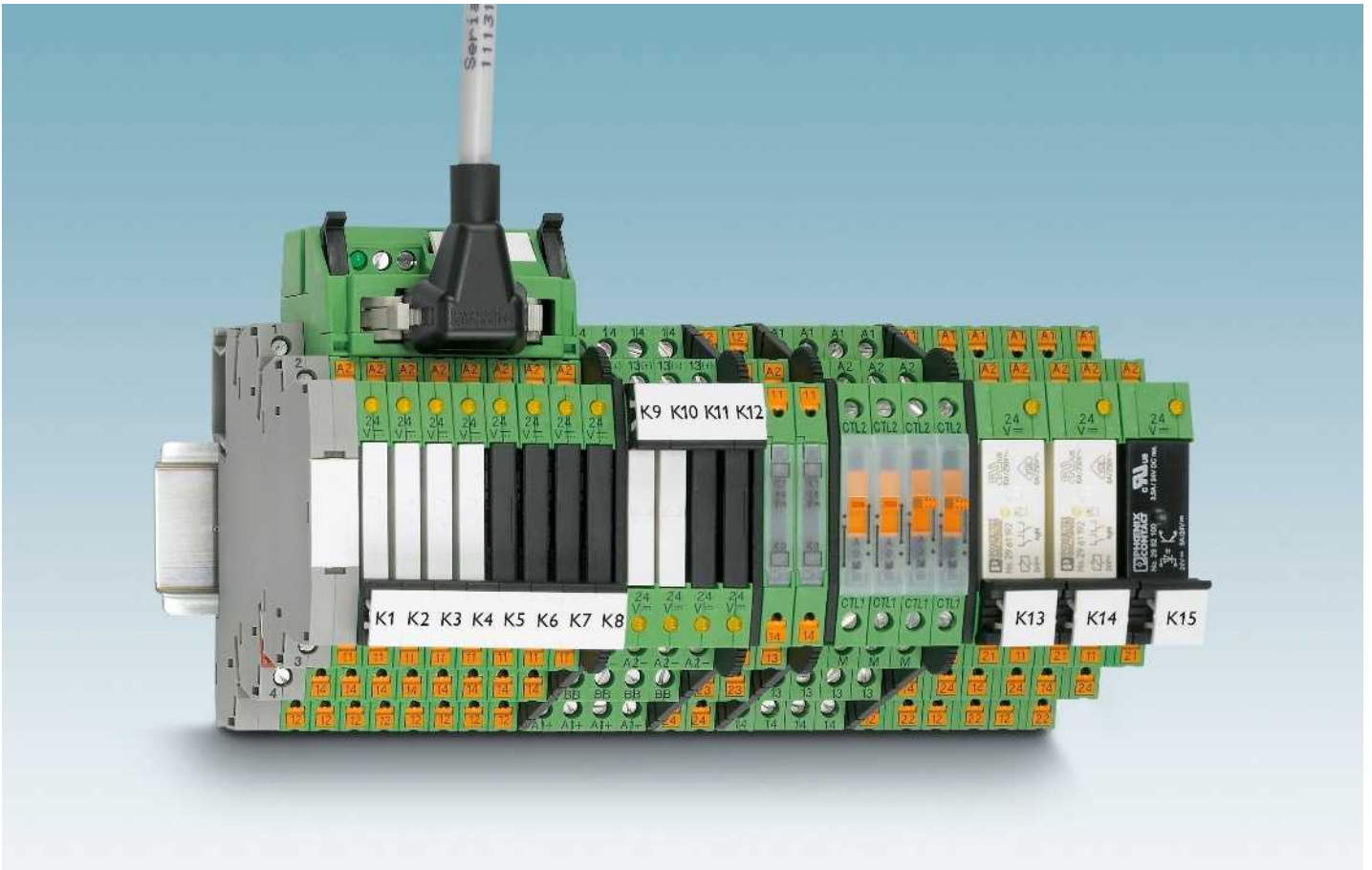

The PLC-INTERFACE relay system is the interface between the controller and system I/O devices.

The universal design is compact and space-saving. While the narrow 6.2 mm module has one contact, the 14 mm version is available with two contacts. The modules can be equipped with either an electromechanical or a solid-state relay.

They are protected against environmental influences by RTIII (IP67). The relays also offer safe isolation according to DIN EN 50178 (VDE 0160).

PLC-INTERFACE is available with three connection technologies. Depending on the area of application, screw, spring-cage or push-in connection can be selected.

In addition to the universal types, PLC-INTERFACE is also available in numerous special versions. These include:

- Sensor and actuator modules that can accommodate all connections directly on the interface
- Modules for high inrush or continuous currents
- Railway modules, which meet specific railway requirements
- Filter modules, which filter out interference on the input side

Plug-in bridges are available for all modules for simple potential distribution. In addition, solutions from system cabling applications offer easy connection to the plant control system. VARIOFACE adapters can be used to reduce wiring effort considerably. Installation is simplified significantly thanks to the integrated input and protective circuit.

Standard marking material from CLIPLINE complete modular terminal blocks can be used to mark PLC-INTERFACE.



Adapters for the system cabling

The PLC-V8... adapter is used to connect 8 PLC-INTERFACE modules to the PLC system cabling for input and output functions. For more details, see page 369



6.2 mm design width

PLC-R...21 and PLC-O... relay and solid-state relay modules with PDT or N/O contact, designed for universal use. Available with screw, spring-cage or push-in connection.



14 mm design width

PLC-R...21-21 includes plug-in relays with two PDT contacts for switching capacities of up to 250 V AC/6 A. Available with screw, spring-cage, and push-in connection.

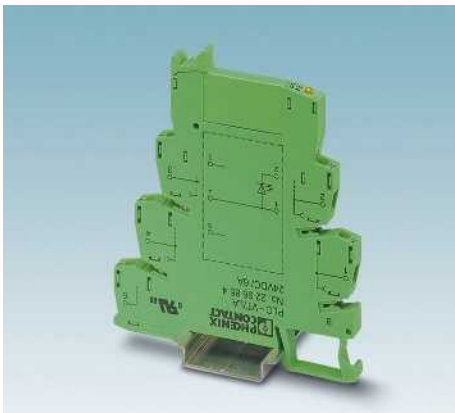

Feed-through terminal block

PLC-VT... is the feed-through terminal block for PLC-INTERFACE and the system cabling for passive signal transfer. For more details, see page 486



Sensors/actuators

PLC...SEN and PLC...ACT do not require additional supply/output terminal blocks. All connections are connected directly.



High currents

PLC...IC is ideal for high inrush currents, e.g., from lamp loads. PLC...HC are the modules to use for applications with high continuous load currents.



Railway applications

PLC...RW relay or solid-state relay modules are suitable for railway requirements. They are only available with spring-cage and push-in connection.

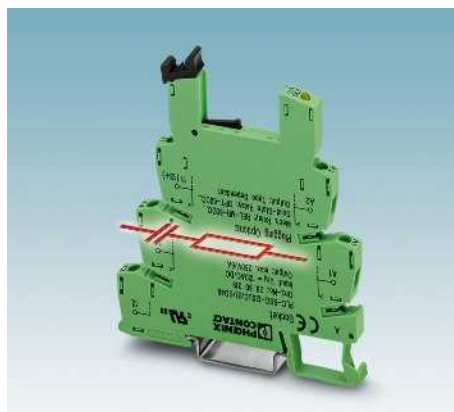

Interference signals on the input side

PLC-B...SO46 basic terminal blocks are used for filtering interference currents and interference voltages on the input side.



Accessories

The entire PLC-INTERFACE system can be extended with a wide range of accessories, such as power terminal blocks or plug-in bridges. For more details, see page 368

Relay modules

PLC series

Universal PLC series with PDT relay

PLC-R... is the relay series that can be used universally and consists of basic terminal blocks and plug-in relays with PDT contacts.

- The advantages:
- Slim design
 - Screw, spring-cage, and push-in technology
 - Functional plug-in bridges
 - Integrated input and interference suppression circuit
 - RT III sealed relay
 - Safe isolation according to DIN EN 50178 between coil and contact
 - Efficient connection to system cabling using V8 adapter

Notes:
Type of housing: Polyamide PA non-reinforced, color: green.
Marking systems and mounting material See Catalog 5
Separating plate PLC-ATP must be installed for voltages larger than 250 V (L1, L2, L3) between identical terminal blocks in adjacent modules. Potential bridging is then carried out with FBST 8-PLC... or FBST 500....
If the specified maximum values for multi-layer contact relays are exceeded, the gold plating is destroyed. The maximum values of the power contact relay are then valid. This can result in a shorter service life than with a pure power contact.
For diagrams of operating voltage ranges, see page 343
Note: for marking material (ZB 6), see "CLIPLINE industrial connection technology, marking material for terminals, conductors, and cables".
1) 120 and 230 V types up to 55°C
2) 230 V types up to 55°C
3) EMC: Class A product, see page 571



1 PDT with power contact

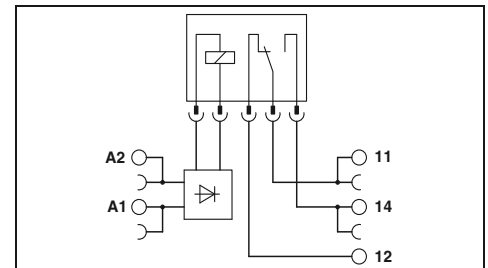

Technical data

Input data	
Typ. input current at U_N	[mA]
Response/release time at U_N	[ms]
Input circuit DC	
Input circuit AC/DC	
Output data	
Contact material	
Max. switching voltage	
Min. switching voltage	
Limiting continuous current	
Max. inrush current	
Min. switching current	
General data	
Test voltage input/output	
Ambient temperature (operation)	
Mechanical service life	
Standards/regulations	
Connection data solid / stranded / AWG	
Dimensions	W / H / D

①	②	③	④	⑤	⑥	⑦
15.3	9	11	9.2	4.8	3.5	3.2
5/8	5/8	6/15	5/8	5/8	6/15	7/15
Yellow LED, Protection against polarity reversal, freewheeling diode						
Yellow LED, Bridge rectifier						
AgSnO						
250 V AC/DC						
5 V (at 100 mA)						
6 A						
(on request)						
10 mA (at 12 V)						
4 kV AC (50 Hz, 1 min.)						
-40°C ... 60°C ¹⁾						
2 x 10 ⁷ cycles						
IEC 60664, EN 50178, IEC 62103						
0.14 - 2.5 mm ² / 0.14 - 2.5 mm ² / 26 - 14						
6.2 mm / 80 mm / 94 mm						

Electrical interrupting rating for PLC...21 with 1-PDT relay

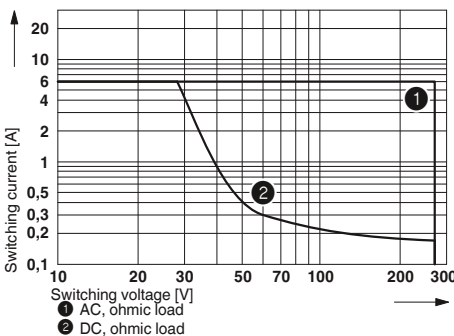

Electrical interrupting rating for PLC...21-21 with 2-PDT relay

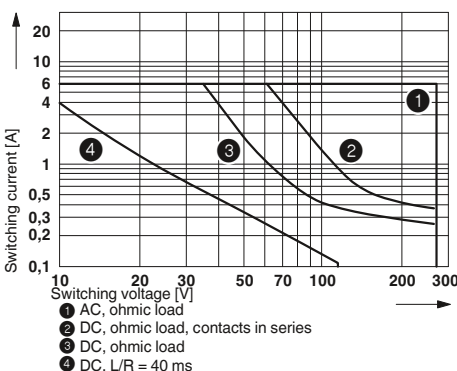

Description	Input voltage U_N
PLC INTERFACE, with screw connection	
①	12 V DC
②	24 V DC
③	24 V AC/DC
④	48 V DC
⑤	60 V DC
⑥	120 V AC (110 V DC)
⑦	230 V AC (220 V DC)
PLC INTERFACE, with spring-cage connection	
①	12 V DC
②	24 V DC
③	24 V AC/DC
④	48 V DC
⑤	60 V DC
⑥	120 V AC (110 V DC)
⑦	230 V AC (220 V DC)
PLC-INTERFACE, with push-in connection	
①	12 V DC
②	24 V DC
③	24 V AC/DC
④	48 V DC
⑤	60 V DC
⑥	120 V AC (110 V DC)
⑦	230 V AC (220 V DC)

Ordering data

Type	Order No.	Pcs. / Pkt.
PLC-RSC- 12DC/21 ³⁾	2966906	10
PLC-RSC- 24DC/21 ³⁾	2966171	10
PLC-RSC- 24UC/21 ³⁾	2966184	10
PLC-RSC- 48DC/21 ³⁾	2966113	10
PLC-RSC- 60DC/21 ³⁾	2966139	10
PLC-RSC-120UC/21 ³⁾	2966197	10
PLC-RSC-230UC/21 ³⁾	2966207	10
PLC-RSP- 12DC/21 ³⁾	2967439	10
PLC-RSP- 24DC/21 ³⁾	2966472	10
PLC-RSP- 24UC/21 ³⁾	2966485	10
PLC-RSP- 48DC/21 ³⁾	2966498	10
PLC-RSP- 60DC/21 ³⁾	2966511	10
PLC-RSP-120UC/21 ³⁾	2966524	10
PLC-RSP-230UC/21 ³⁾	2966537	10
PLC-RPT- 12DC/21 ³⁾	2900316	10
PLC-RPT- 24DC/21 ³⁾	2900299	10
PLC-RPT- 24UC/21 ³⁾	2900300	10
PLC-RPT- 48DC/21 ³⁾	2900301	10
PLC-RPT- 60DC/21 ³⁾	2900303	10
PLC-RPT-120UC/21 ³⁾	2900304	10
PLC-RPT-230UC/21 ³⁾	2900305	10



1 PDT with multi-layer gold contact



2 PDT with power contact



2 PDT with multi-layer gold contact

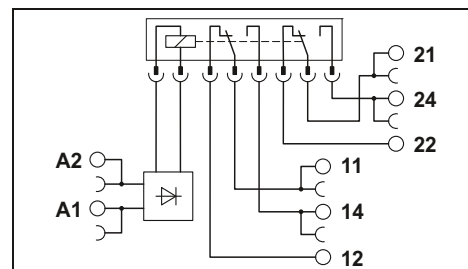
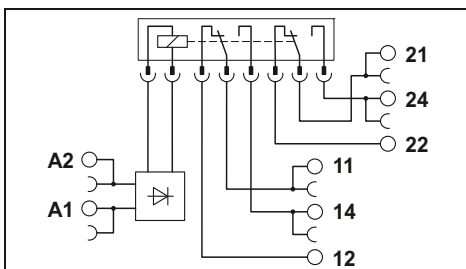
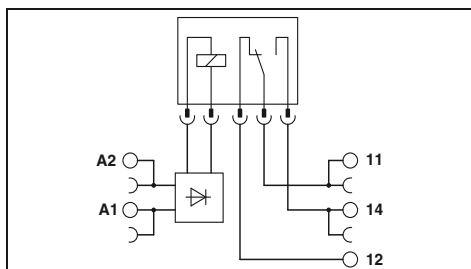

Technical data

①	②	③	④	⑤	⑥	⑦
15.3	9	11	9.2	4.8	3.5	3.2
5/8	5/8	6/15	5/8	5/8	6/15	7/15
Yellow LED, Protection against polarity reversal, freewheeling diode						
Yellow LED, Bridge rectifier						

AgSnO, hard gold-plated
 30 V AC / 36 V DC
 100 mV (at 10 mA)
 50 mA
 50 mA
 1 mA (at 24 V)

4 kV AC (50 Hz, 1 min.)
 -40°C ... 60°C¹⁾
 2 x 10⁷ cycles
 IEC 60664, EN 50178, IEC 62103
 0.14 - 2.5 mm² / 0.14 - 2.5 mm² / 26 - 14
 6.2 mm / 80 mm / 94 mm

Technical data

①	②	③	④	⑤	⑥	⑦
33	18	17.5	20	10	4.5	4.5
8/10	8/10	8/10	8/10	8/10	7/10	7/10
Yellow LED, Protection against polarity reversal, freewheeling diode						
Yellow LED, Bridge rectifier						

AgNi
 250 V AC/DC
 5 V AC/DC (at 10 mA)
 6 A
 15 A (300 ms)
 10 mA (At 5 V)

4 kV AC (50 Hz, 1 min.)
 -40°C ... 60°C²⁾
 3 x 10⁷ cycles
 IEC 60664, EN 50178, IEC 62103
 0.14 - 2.5 mm² / 0.14 - 2.5 mm² / 26 - 14
 14 mm / 80 mm / 94 mm

Technical data

①	②	③	④	⑤	⑥	⑦
33	18	17.5	20	10	4.5	4.5
8/10	8/10	8/10	8/10	8/10	7/10	7/10
Yellow LED, Protection against polarity reversal, freewheeling diode						
Yellow LED, Bridge rectifier						

AgNi, hard gold-plated
 30 V AC / 36 V DC
 100 mV (at 10 mA)
 50 mA
 50 mA
 1 mA (at 24 V)

4 kV AC (50 Hz, 1 min.)
 -40°C ... 60°C²⁾
 3 x 10⁷ cycles
 IEC 60664, EN 50178, IEC 62103
 0.14 - 2.5 mm² / 0.14 - 2.5 mm² / 26 - 14
 14 mm / 80 mm / 94 mm

Ordering data

Type	Order No.	Pcs. / Pkt.
PLC-RSC- 12DC/21AU ³⁾	2966919	10
PLC-RSC- 24DC/21AU ³⁾	2966265	10
PLC-RSC- 24UC/21AU ³⁾	2966278	10
PLC-RSC- 48DC/21AU ³⁾	2966126	10
PLC-RSC- 60DC/21AU ³⁾	2966142	10
PLC-RSC-120UC/21AU ³⁾	2966281	10
PLC-RSC-230UC/21AU ³⁾	2966294	10
PLC-RSP- 12DC/21AU ³⁾	2967442	10
PLC-RSP- 24DC/21AU ³⁾	2966540	10
PLC-RSP- 24UC/21AU ³⁾	2966553	10
PLC-RSP- 48DC/21AU ³⁾	2966566	10
PLC-RSP- 60DC/21AU ³⁾	2966579	10
PLC-RSP-120UC/21AU ³⁾	2966582	10
PLC-RSP-230UC/21AU ³⁾	2966647	10
PLC-RPT- 12DC/21AU ³⁾	2900317	10
PLC-RPT- 24DC/21AU ³⁾	2900306	10
PLC-RPT- 24UC/21AU ³⁾	2900307	10
PLC-RPT- 48DC/21AU ³⁾	2900308	10
PLC-RPT- 60DC/21AU ³⁾	2900309	10
PLC-RPT-120UC/21AU ³⁾	2900310	10
PLC-RPT-230UC/21AU ³⁾	2900311	10

Ordering data

Type	Order No.	Pcs. / Pkt.
PLC-RSC- 12DC/21-21 ³⁾	2967235	10
PLC-RSC- 24DC/21-21 ³⁾	2967060	10
PLC-RSC- 24UC/21-21 ³⁾	2967073	10
PLC-RSC- 48DC/21-21 ³⁾	2967248	10
PLC-RSC- 60DC/21-21 ³⁾	2967293	10
PLC-RSC-120UC/21-21 ³⁾	2967086	10
PLC-RSC-230UC/21-21 ³⁾	2967099	10
PLC-RSP- 12DC/21-21 ³⁾	2912497	10
PLC-RSP- 24DC/21-21 ³⁾	2912507	10
PLC-RSP- 24UC/21-21 ³⁾	2912510	10
PLC-RSP- 48DC/21-21 ³⁾	2912523	10
PLC-RSP- 60DC/21-21 ³⁾	2912536	10
PLC-RSP-120UC/21-21 ³⁾	2912549	10
PLC-RSP-230UC/21-21 ³⁾	2912552	10
PLC-RPT- 12DC/21-21 ³⁾	2900329	10
PLC-RPT- 24DC/21-21 ³⁾	2900330	10
PLC-RPT- 24UC/21-21 ³⁾	2900332	10
PLC-RPT- 48DC/21-21 ³⁾	2900333	10
PLC-RPT- 60DC/21-21 ³⁾	2900334	10
PLC-RPT-120UC/21-21 ³⁾	2900335	10
PLC-RPT-230UC/21-21 ³⁾	2900336	10

Ordering data

Type	Order No.	Pcs. / Pkt.
PLC-RSC- 12DC/21-21AU ³⁾	2967277	10
PLC-RSC- 24DC/21-21AU ³⁾	2967125	10
PLC-RSC- 24UC/21-21AU ³⁾	2967112	10
PLC-RSC- 48DC/21-21AU ³⁾	2967280	10
PLC-RSC- 60DC/21-21AU ³⁾	2967303	10
PLC-RSC-120UC/21-21AU ³⁾	2967138	10
PLC-RSC-230UC/21-21AU ³⁾	2967141	10
PLC-RSP- 12DC/21-21AU ³⁾	2912565	10
PLC-RSP- 24DC/21-21AU ³⁾	2912578	10
PLC-RSP- 24UC/21-21AU ³⁾	2912581	10
PLC-RSP- 48DC/21-21AU ³⁾	2912594	10
PLC-RSP- 60DC/21-21AU ³⁾	2912604	10
PLC-RSP-120UC/21-21AU ³⁾	2912617	10
PLC-RSP-230UC/21-21AU ³⁾	2912620	10
PLC-RPT- 12DC/21-21AU ³⁾	2900337	10
PLC-RPT- 24DC/21-21AU ³⁾	2900338	10
PLC-RPT- 24UC/21-21AU ³⁾	2900339	10
PLC-RPT- 48DC/21-21AU ³⁾	2900340	10
PLC-RPT- 60DC/21-21AU ³⁾	2900341	10
PLC-RPT-120UC/21-21AU ³⁾	2900342	10
PLC-RPT-230UC/21-21AU ³⁾	2900343	10

Relay modules

PLC series

Universal PLC series with solid-state relays

PLC-O... is the solid-state relay series that can be used universally consisting of basic terminal blocks and plug-in solid-state relays.

The advantages:

- Slim design
- Screw, spring-cage, and push-in technology
- Functional plug-in bridges
- Integrated input circuit
- RT-III sealed solid-state relays
- High switching capacity
- Zero voltage switch at AC output
- Efficient connection to system cabling using V8 adapter

Notes:
Type of housing: Polyamide PA non-reinforced, color: green.
Marking systems and mounting material See Catalog 5
Separating plate PLC-ATP must be installed for voltages larger than 250 V (L1, L2, L3) between identical terminal blocks in adjacent modules. Potential bridging is then carried out with FBST 8-PLC... or FBST 500....
For derating curves see page 345
1) EMC: Class A product, see page 571



Max. DC voltage output of 100 mA



Input data	
Permissible range (with reference to U_N)	
Switching level (with reference to U_N)	1 signal ("H") 0 signal ("L")
Typ. input current at U_N	[mA]
Typ. switch-on time at U_N	[ms]
Typ. switch-off time at U_N	[ms]
Transmission frequency f_{limit}	[Hz]
Input circuit DC	
Input circuit AC/DC	
Output data	
Max. switching voltage	48 V DC
Min. switching voltage	3 V DC
Max. inrush current	-
Min./max. switching current	- / 100 mA
Output protection	Protection against polarity reversal, Surge protection
Voltage drop at max. limiting continuous current	≤ 1 V
Leakage current in off state	-
Phase angle (cos ϕ)	-
Max. load value	-
General data	
Test voltage input/output	2.5 kV (50 Hz, 1 min.)
Ambient temperature (operation)	-25°C ... 60°C
Standards/regulations	IEC 60664, EN 50178, IEC 62103
Pollution degree/surge voltage category	2 / III
Connection data solid / stranded / AWG	0.14 - 2.5 mm ² / 0.14 - 2.5 mm ² / 26 - 14
Dimensions	W / H / D 6.2 mm / 80 mm / 94 mm

Technical data					
①	②	③	④	⑤	⑥
0.8 - 1.2	0.8 - 1.2	0.8 - 1.2	0.8 - 1.1	0.9 - 1.1	0.9 - 1.1
≥ 0.8	≥ 0.8	≥ 0.8	≥ 0.8	≥ 0.9	≥ 0.8
≤ 0.4	≤ 0.3	≤ 0.4	≤ 0.4	≤ 0.3	≤ 0.3
8.5	9	5	3	3.5	3.5
0.02	0.03	0.04	1	3	3
0.3	0.3	2	3	4	5
300	300	100	50	10	10

Yellow LED, Protection against polarity reversal, freewheeling diode
Yellow LED, Bridge rectifier

Description	Input voltage U_N
PLC INTERFACE, with screw connection	
①	24 V DC
②	48 V DC
③	60 V DC
④	125 V DC
⑤	120 V AC (110 V DC)
⑥	230 V AC (220 V DC)
PLC INTERFACE, with spring-cage connection	
①	24 V DC
②	48 V DC
③	60 V DC
④	120 V AC (110 V DC)
⑤	230 V AC (220 V DC)
PLC-INTERFACE, with push-in connection	
①	24 V DC
②	48 V DC
③	60 V DC
④	120 V AC (110 V DC)
⑤	230 V AC (220 V DC)

Ordering data		
Type	Order No.	Pcs. / Pkt.
PLC-OSC- 24DC/ 48DC/100 ¹)	2966728	10
PLC-OSC- 48DC/ 48DC/100 ¹)	2966993	10
PLC-OSC- 60DC/ 48DC/100 ¹)	2967455	10
PLC-OSC-125DC/ 48DC/100 ¹)	2980047	10
PLC-OSC-120UC/ 48DC/100 ¹)	2966744	10
PLC-OSC-230UC/ 48DC/100 ¹)	2966757	10
PLC-OSP- 24DC/ 48DC/100 ¹)	2967549	10
PLC-OSP- 48DC/ 48DC/100 ¹)	2967743	10
PLC-OSP- 60DC/ 48DC/100 ¹)	2967756	10
PLC-OSP-120UC/ 48DC/100 ¹)	2967552	10
PLC-OSP-230UC/ 48DC/100 ¹)	2967565	10
PLC-OPT- 24DC/ 48DC/100 ¹)	2900352	10
PLC-OPT- 48DC/ 48DC/100 ¹)	2900353	10
PLC-OPT- 60DC/ 48DC/100 ¹)	2900354	10
PLC-OPT-120UC/ 48DC/100 ¹)	2900355	10
PLC-OPT-230UC/ 48DC/100 ¹)	2900356	10

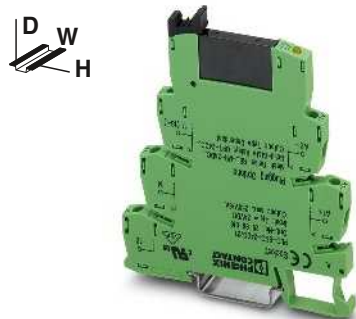

Max. DC voltage output of 3 A

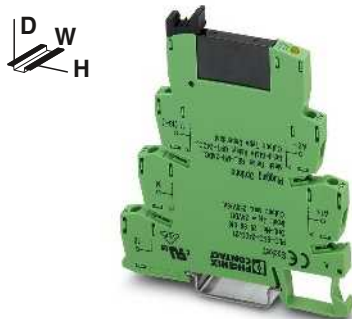

Max. AC voltage output of 750 mA

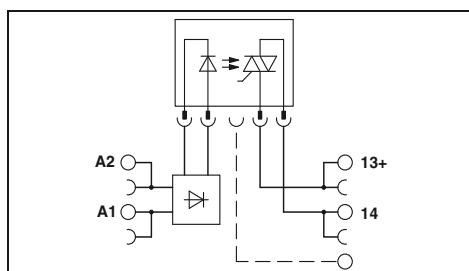
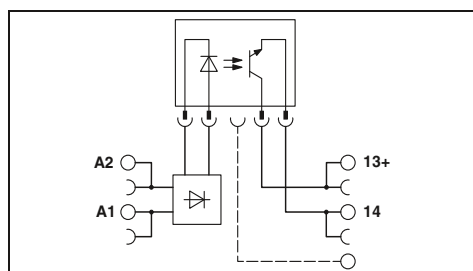

Technical data

①	②	③	④	⑤	⑥
0.8 - 1.2	0.8 - 1.2	0.8 - 1.2	0.8 - 1.1	0.9 - 1.1	0.9 - 1.1
≥ 0.8	≥ 0.8	≥ 0.8	≥ 0.8	≥ 0.8	≥ 0.8
≤ 0.4	≤ 0.4	≤ 0.3	≤ 0.3	≤ 0.3	≤ 0.3
8.5	9	5	3	3.5	3.5
0.02	0.03	0.04	0.04	3.5	4
0.3	0.3	0.5	0.6	7	7
300	300	100	100	10	10

Yellow LED, Protection against polarity reversal, freewheeling diode
Yellow LED, Bridge rectifier

33 V DC
3 V DC
15 A (10 ms)
- / 3 A (see derating curve)

Protection against polarity reversal, Surge protection
≤ 200 mV
-
-

2.5 kV (50 Hz, 1 min.)
-25°C ... 60°C
IEC 60664, EN 50178, IEC 62103
2 / III
0.14 - 2.5 mm² / 0.14 - 2.5 mm² / 26 - 14
6.2 mm / 80 mm / 94 mm

Technical data

①	②	③	④	⑤	⑥
0.8 - 1.2	0.8 - 1.2	0.8 - 1.2	0.8 - 1.1	0.9 - 1.1	0.8 - 1.1
≥ 0.8	≥ 0.8	≥ 0.8	≥ 0.8	≥ 0.8	≥ 0.8
≤ 0.25	≤ 0.25	≤ 0.3	≤ 0.3	≤ 0.25	≤ 0.25
8	9	6	3.5	4	3.5
10	10	10	10	10	10
10	10	10	10	10	10
10	10	10	10	3	3

253 V AC
24 V AC
30 A (10 ms)
10 mA / 0.75 A (see derating curve)
RCV circuit
< 1 V
< 1 mA (in off state)
0.5
4.5 A_{RS}

2.5 kV (50 Hz, 1 min.)
-25°C ... 60°C
IEC 60664, EN 50178, IEC 62103
2 / III
0.14 - 2.5 mm² / 0.14 - 2.5 mm² / 26 - 14
6.2 mm / 80 mm / 94 mm

Ordering data

Type	Order No.	Pcs. / Pkt.
PLC-OSC- 24DC/ 24DC/ 2')	2966634	10
PLC-OSC- 48DC/ 24DC/ 2')	2967002	10
PLC-OSC- 60DC/ 24DC/ 2')	2967468	10
PLC-OSC-125DC/ 24DC/ 2')	2980050	10
PLC-OSC-120UC/ 24DC/ 2')	2966650	10
PLC-OSC-230UC/ 24DC/ 2')	2966663	10
PLC-OSP- 24DC/ 24DC/ 2')	2967471	10
PLC-OSP- 48DC/ 24DC/ 2')	2967727	10
PLC-OSP- 60DC/ 24DC/ 2')	2967730	10
PLC-OSP-120UC/ 24DC/ 2')	2967484	10
PLC-OSP-230UC/ 24DC/ 2')	2967497	10
PLC-OPT- 24DC/ 24DC/2')	2900364	10
PLC-OPT- 48DC/ 24DC/2')	2900365	10
PLC-OPT- 60DC/ 24DC/2')	2900366	10
PLC-OPT-120UC/ 24DC/2')	2900367	10
PLC-OPT-230UC/ 24DC/2')	2900368	10

Ordering data

Type	Order No.	Pcs. / Pkt.
PLC-OSC- 24DC/230AC/ 1')	2967840	10
PLC-OSC- 48DC/230AC/ 1')	2967853	10
PLC-OSC- 60DC/230AC/ 1')	2967866	10
PLC-OSC-125DC/230AC/ 1')	2980063	10
PLC-OSC-120UC/230AC/ 1')	2967879	10
PLC-OSC-230UC/230AC/ 1')	2967882	10
PLC-OSP- 24DC/230AC/ 1')	2967895	10
PLC-OSP- 48DC/230AC/ 1')	2967905	10
PLC-OSP- 60DC/230AC/ 1')	2967918	10
PLC-OSP-120UC/230AC/ 1')	2967921	10
PLC-OSP-230UC/230AC/ 1')	2967934	10
PLC-OPT- 24DC/230AC/1')	2900369	10
PLC-OPT- 48DC/230AC/1')	2900370	10
PLC-OPT- 60DC/230AC/1')	2900371	10
PLC-OPT-120UC/230AC/1')	2900372	10
PLC-OPT-230UC/230AC/1')	2900374	10

Relay modules

PLC series

PLC actuator series for output functions

PLC actuator series for coupling controller and actuators, such as motors, contactors, valves, etc.

The advantages:

- Actuator connected directly to relay module
- No need for additional modular terminal blocks
- Space savings of up to 80%
- Time savings of up to 60%
- Screw, spring-cage, and push-in technology
- Relay modules with safe isolation according to DIN EN 50178 between coil and contact
- Functional plug-in bridges
- Efficient connection to system cabling using V8 adapter

Notes:
Type of housing: Polyamide PA non-reinforced, color: green.
Marking systems and mounting material See Catalog 5
Separating plate PLC-ATP must be installed for voltages larger than 250 V (L1, L2, L3) between identical terminal blocks in adjacent modules. Potential bridging is then carried out with FBST 8-PLC... or FBST 500....
For diagrams of operating voltage ranges, see page 343
For derating curves see page 345
1) EMC: Class A product, see page 571



1 N/O contact with power contact

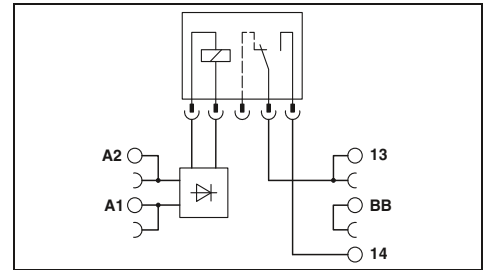

Technical data

Technical data	
Input data	See diagram
Permissible range (with reference to U_N)	
Switching level (with reference to U_N)	1 signal ("H") 0 signal ("L")
Typ. input current at U_N	[mA] 9
Typ. response time/switch-on time at U_N	[ms] 5
Typ. release time/switch-off time at U_N	[ms] 8
Transmission frequency f_{limit}	[Hz]
Input circuit DC	Yellow LED, Protection against polarity reversal, freewheeling diode
Output data	
Contact material	AgSnO
Max. switching voltage	250 V AC/DC
Min. switching voltage	5 V (at 100 mA)
Limiting continuous current	6 A
Max. inrush current	(on request)
Min. switching current	10 mA (at 12 V)
Output protection	-
Voltage drop at max. limiting continuous current	-
Leakage current in off state	-
Phase angle (cos ϕ)	-
Max. load value	-
General data	
Test voltage input/output	4 kV AC (50 Hz, 1 min.)
Ambient temperature (operation)	-40°C ... 60°C
Mechanical service life	2 x 10 ⁷ cycles
Standards/regulations	IEC 60664, EN 50178, IEC 62103
Pollution degree/surge voltage category	3 / III
Connection data solid / stranded / AWG	0.14 - 2.5 mm ² / 0.14 - 2.5 mm ² / 26 - 14
Dimensions	W / H / D 6.2 mm / 80 mm / 94 mm

Electrical interrupting rating for PLC...24DC/1/ACT with 1-N/O relay

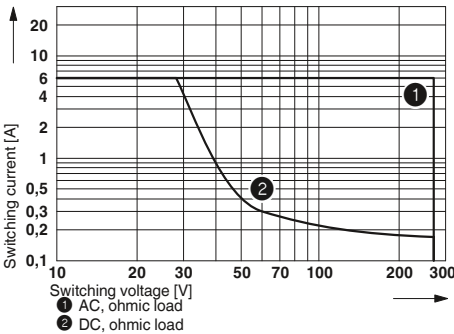

Electrical interrupting rating for PLC...24DC/1-1/ACT with 2-N/O relay

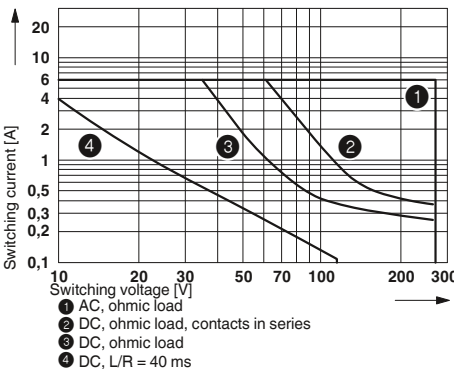

Description	Input voltage U_N
PLC INTERFACE, with screw connection	
①	5 V DC
②	24 V DC
PLC INTERFACE, with spring-cage connection	
①	5 V DC
②	24 V DC
PLC-INTERFACE, with push-in connection	
①	5 V DC
②	24 V DC

Ordering data

Type	Order No.	Pcs. / Pkt.
PLC-RSC- 24DC/ 1/ACT ¹⁾	2966210	10
PLC-RSP- 24DC/ 1/ACT ¹⁾	2967345	10
PLC-RPT- 24DC/ 1/ACT ¹⁾	2900312	10

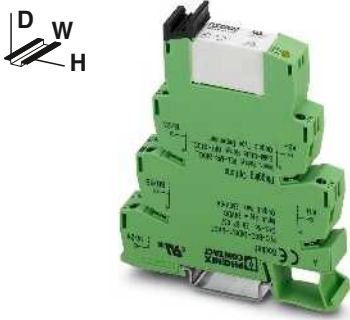

2 N/O contacts with power contact

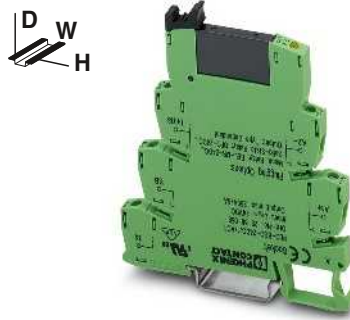

Max. DC voltage output of 3 A

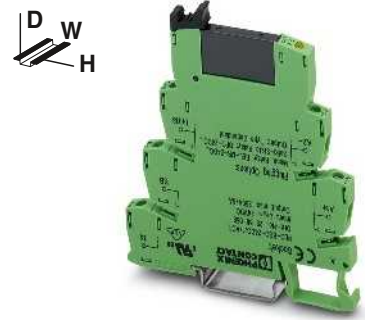

Max. AC voltage output of 750 mA

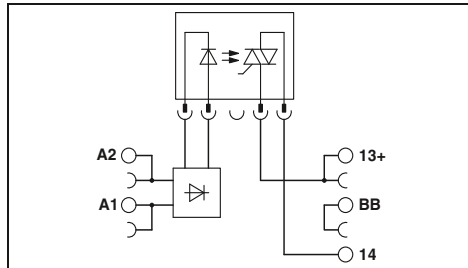
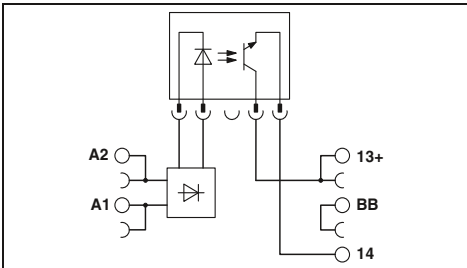
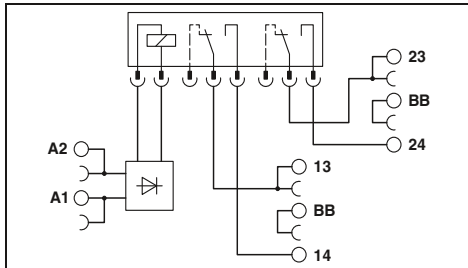

Technical data

Technical data

Technical data

②	
See diagram	
18	
8	
10	
Yellow LED, Protection against polarity reversal, freewheeling diode	
AgNi	
250 V AC/DC	
5 V AC/DC	
6 A	
8 A	
10 mA	
-	
-	
-	
-	
-	
4 kV AC (50 Hz, 1 min.)	
-40°C ... 60°C	
3 x 10 ⁷ cycles	
IEC 60664, EN 50178, IEC 62103	
2 / III	
0.14 - 2.5 mm ² / 0.14 - 2.5 mm ² / 26 - 14	
14 mm / 80 mm / 94 mm	

①	②
0.8 -	0.8 -
1.2	1.2
≥ 0.8	≥ 0.8
≤ 0.25	≤ 0.4
9.5	8.5
0.02	0.02
0.3	0.3
300	300
Yellow LED, Protection against polarity reversal, freewheeling diode	
-	
33 V DC	
3 V DC	
3 A (see derating curve)	
15 A (10 ms)	
-	
Protection against polarity reversal, Surge protection	
≤ 200 mV	
-	
-	
-	
-	
2.5 kV (50 Hz, 1 min.)	
-25°C ... 60°C	
-	
IEC 60664, EN 50178, IEC 62103	
2 / III	
0.14 - 2.5 mm ² / 0.14 - 2.5 mm ² / 26 - 14	
6.2 mm / 80 mm / 94 mm	

②	
0.8 -	
1.2	
≥ 0.8	
≤ 0.25	
9	
3	
9	
10	
Yellow LED, Protection against polarity reversal, freewheeling diode	
-	
253 V AC	
24 V AC	
0.75 A (see derating curve)	
30 A (10 ms)	
10 mA	
RCV circuit	
< 1 V	
< 1 mA (in off state)	
0.5	
4.5 A ^{2s}	
-	
2.5 kV (50 Hz, 1 min.)	
-25°C ... 60°C	
-	
IEC 60664, EN 50178, IEC 62103	
2 / III	
0.14 - 2.5 mm ² / 0.14 - 2.5 mm ² / 26 - 14	
6.2 mm / 80 mm / 94 mm	

Ordering data

Ordering data

Ordering data

Type	Order No.	Pcs. / Pkt.
PLC-RSC- 24DC/ 1- 1/ACT ¹⁾	2967109	10

Type	Order No.	Pcs. / Pkt.
PLC-OSC- 5DC/ 24DC/ 2/ACT ¹⁾	2980144	10
PLC-OSC- 24DC/ 24DC/ 2/ACT ¹⁾	2966676	10
PLC-OSP- 5DC/ 24DC/ 2/ACT ¹⁾	2980157	10
PLC-OSP- 24DC/ 24DC/ 2/ACT ¹⁾	2967507	10
PLC-OPT- 5DC/ 24DC/2/ACT ¹⁾	2900375	10
PLC-OPT- 24DC/ 24DC/2/ACT ¹⁾	2900376	10

Type	Order No.	Pcs. / Pkt.
PLC-OSC- 24DC/230AC/ 1/ACT ¹⁾	2967947	10

Relay modules

PLC series

PLC actuator series for output functions

PLC actuator series with solid-state power relays for coupling the controller and actuators, such as motors, contactors, valves, etc.

Notes:
Type of housing: Polyamide PA non-reinforced, color: green.
Marking systems and mounting material See Catalog 5
Separating plate PLC-ATP must be installed for voltages larger than 250 V (L1, L2, L3) between identical terminal blocks in adjacent modules. Potential bridging is then carried out with FBST 8-PLC... or FBST 500....
For derating curves see page 345



Max. DC voltage output of 5 A

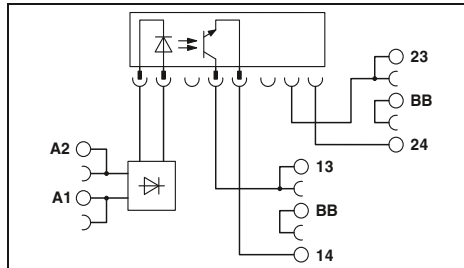

Technical data

Input data	①
Permissible range (with reference to U_N)	0.8 - 1.2
Switching level (with reference to U_N)	1 signal ("H") ≥ 0.8 0 signal ("L") ≤ 0.4
Typ. input current at U_N	[mA] 9
Typ. switch-on time at U_N	[ms] 0.02
Typ. switch-off time at U_N	[ms] 0.4
Transmission frequency f_{limit}	[Hz] 300
Input circuit DC	Yellow LED, Protection against polarity reversal, freewheeling diode
Output data	
Max. / min. switching voltage	33 V DC / 3 V DC
Max. inrush current	15 A (10 ms)
Min./max. switching current	- / 5 A (see derating curve)
Output protection	Protection against polarity reversal, Surge protection
Voltage drop at max. limiting continuous current	≤ 200 mV
Leakage current in off state	-
Phase angle (cos ϕ)	-
Max. load value	-
General data	
Rated insulation voltage	100 V DC
Rated surge voltage	1.5 kV, basic insulation
Ambient temperature (operation)	-20°C ... 60°C
Standards/regulations	IEC 60664, EN 50178, IEC 62103
Pollution degree/surge voltage category	2 / III
Mounting position/mounting	Refer to Derating / In rows with zero spacing
Connection data solid / stranded / AWG	0.14 - 2.5 mm ² / 0.14 - 2.5 mm ² / 26 - 14
Dimensions	14 mm / 80 mm / 94 mm



Max. AC voltage output of 2 mA

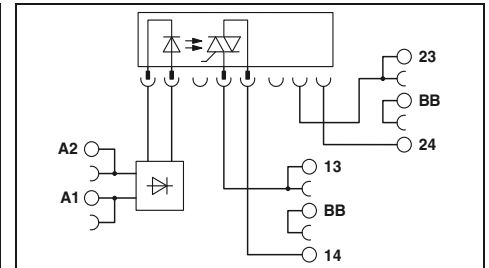

Technical data

Input data	①
Permissible range (with reference to U_N)	0.8 - 1.2
Switching level (with reference to U_N)	1 signal ("H") ≥ 0.8 0 signal ("L") ≤ 0.4
Typ. input current at U_N	[mA] 9
Typ. switch-on time at U_N	[ms] 10
Typ. switch-off time at U_N	[ms] 10
Transmission frequency f_{limit}	[Hz] 10
Input circuit DC	Yellow LED, Protection against polarity reversal, freewheeling diode
Output data	
Max. / min. switching voltage	253 V AC / 24 V AC
Max. inrush current	30 A (10 ms)
Min./max. switching current	25 mA / 2 A (see derating curve)
Output protection	Surge protection
Voltage drop at max. limiting continuous current	≤ 1 V
Leakage current in off state	Typ. 1 mA
Phase angle (cos ϕ)	0.5
Max. load value	4 A ² s (tp = 10 ms, at 25°C)
General data	
Rated insulation voltage	250 V AC
Rated surge voltage	4 kV / basic insulation
Ambient temperature (operation)	-20°C ... 60°C
Standards/regulations	IEC 60664, EN 50178, IEC 62103
Pollution degree/surge voltage category	2 / III
Mounting position/mounting	Refer to Derating / In rows with zero spacing
Connection data solid / stranded / AWG	0.14 - 2.5 mm ² / 0.14 - 2.5 mm ² / 26 - 14
Dimensions	14 mm / 80 mm / 94 mm

Ordering data

Description	Input voltage U_N
PLC INTERFACE, with screw connection	24 V DC

Type	Order No.	Pcs. / Pkt.
PLC-OSC- 24DC/ 24DC/ 5/ACT	2982786	10

Ordering data

Description	Input voltage U_N
PLC INTERFACE, with screw connection	24 V AC

Type	Order No.	Pcs. / Pkt.
PLC-OSC- 24DC/230AC/ 2/ACT	2982760	10

PLC actuator series for output functions

PLC actuator basic terminal blocks that can be fitted with a mechanical or solid-state relay. For coupling the controller and actuators, such as motors, contactors, valves, etc.

Notes:
Maximum interrupting rating diagrams, see page 346
For derating curves see page 345
1) EMC: Class A product, see page 571



Basic terminal block that can be fitted with mech. relay



Basic terminal block that can be fitted with solid-state relay

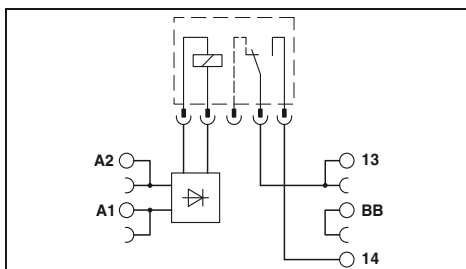

Technical data

Input data	
Permissible range (with reference to U_N)	0.8 ... 1.2
Typ. input current with U_N (50 /60 Hz)	15.6 mA / 8.5 mA
Typ. response time at U_N	5 ms
Typ. release time at U_N	30 ms
Input circuit	LED yellow, Bridge rectifier
Output data with:	REL-MR-24DC/21AU REL-MR-24DC/21
Contact type	Single contact, 1 N/O contact Single contact, 1 N/O contact
Contact material	AgSnO, hard gold-plated AgSnO
Max. switching voltage	30 V AC / 36 V DC 250 V AC/DC
Min. switching voltage	100 mV (at 10 mA) 5 V (at 100 mA)
Limiting continuous current	50 mA 6 A
Min. switching current	1 mA (at 24 V) 10 mA (at 12 V)
Output protection	- -
Voltage drop at limiting continuous current	- -
Leakage current in off state	- -
Max. load value $I^2 \times t$ (t = 10 ms)	- -
General data	
Rated insulation voltage	250 V AC
Rated surge voltage / insulation	6 kV / Safe isolation, increased insulation
Ambient temperature (operation)	-20°C ... 60°C
Air and creepage distances	EN 50178, IEC 62103
Pollution degree / Surge voltage category	2 / III
Connection data solid / stranded / AWG	0.14 - 2.5 mm ² / 0.14 - 2.5 mm ² / 26 - 14
Dimensions	W / H / D 6.2 mm / 80 mm / 94 mm

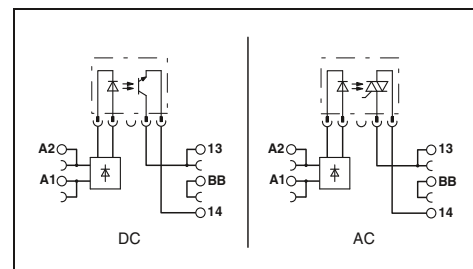

Technical data

Input data		
Permissible range (with reference to U_N)	0.8 ... 1.2	
Typ. input current with U_N (50 /60 Hz)	15 mA / 8.3 mA	
Typ. response time at U_N	10 ms	
Typ. release time at U_N	20 ms	
Input circuit	Yellow LED, Bridge rectifier	
Output data with:	OPT...48DC/... OPT...24DC/... OPT...230AC/...	
Contact type	- - -	
Contact material	- - -	
Max. switching voltage	48 V DC 33 V DC 253 V AC	
Min. switching voltage	3 V DC 3 V DC 24 V AC	
Limiting continuous current	100 mA 3 A 0.75 A	(see derating curve)
Min. switching current	- - -	
Output protection	Protection against polarity reversal, Surge protection	RCV circuit
Voltage drop at limiting continuous current	≤ 1 V	≤ 1 V
Leakage current in off state	≤ 150 mV	≤ 1 mA
Max. load value $I^2 \times t$ (t = 10 ms)	-	4.5 A ² s (tp = 10 ms, at 25°C)
General data		
Rated insulation voltage	250 V AC	
Rated surge voltage / insulation	6 kV / Safe isolation, increased insulation	
Ambient temperature (operation)	-20°C ... 60°C	
Air and creepage distances	EN 50178, IEC 62103	
Pollution degree / Surge voltage category	2 / III	
Connection data solid / stranded / AWG	0.14 - 2.5 mm ² / 0.14 - 2.5 mm ² / 26 - 14	
Dimensions	W / H / D 6.2 mm / 80 mm / 94 mm	

Ordering data

Description	Voltage U_N
PLC INTERFACE, with screw connection	24 V AC/DC
PLC INTERFACE, with spring-cage connection	24 V AC/DC
PLC-INTERFACE, with push-in connection	24 V AC/DC

Type	Order No.	Pcs. / Pkt.
PLC-BSC- 24UC/ 1/ACT	2982799	10
PLC-BSP- 24UC/ 1/ACT	2982809	10
PLC-BPT- 24UC/ 1/ACT ¹⁾	2900450	10

Ordering data

Type	Order No.	Pcs. / Pkt.
PLC-BSC- 24UC/ 1/ACT	2982799	10
PLC-BSP- 24UC/ 1/ACT	2982809	10
PLC-BPT- 24UC/ 1/ACT ¹⁾	2900450	10

Accessories

Plug-in miniature relays with gold contact with power contact
Plug-in solid-state relays Solid-state input relays Solid-state power relays Solid-state power relays

REL-MR- 24DC/21AU	2961121	10
REL-MR- 24DC/21	2961105	10

Accessories

OPT-24DC/ 48DC/100	2966618	10
OPT-24DC/ 24DC/ 2	2966595	10
OPT-24DC/230AC/ 1	2967950	10

Relay modules

PLC series

PLC sensor series for input functions

PLC sensor series for coupling controller and sensors, such as proximity switches, limit switches or auxiliary contacts

The advantages:

- Direct connection of sensor to relay module
- No need for additional modular terminal blocks
- Space savings of up to 80%
- Time savings of up to 60%
- Screw, spring-cage, and push-in technology
- Relay modules with safe isolation according to DIN EN 50178 between coil and contact
- Functional plug-in bridges
- Efficient connection to system cabling using V8 adapter

Notes:
Type of housing: Polyamide PA non-reinforced, color: green.
Marking systems and mounting material See Catalog 5
Separating plate PLC-ATP must be installed for voltages larger than 250 V (L1, L2, L3) between identical terminal blocks in adjacent modules. Potential bridging is then carried out with FBST 8-PLC... or FBST 500....
If the specified maximum values for multi-layer contact relays are exceeded, the gold plating is destroyed. The maximum values of the power contact relay are then valid. This can result in a shorter service life than with a pure power contact.
For diagrams of operating voltage ranges, see page 343
1) 120 and 230 V types up to 55°C
2) EMC: Class A product, see page 571



Relay module
1 N/O contact

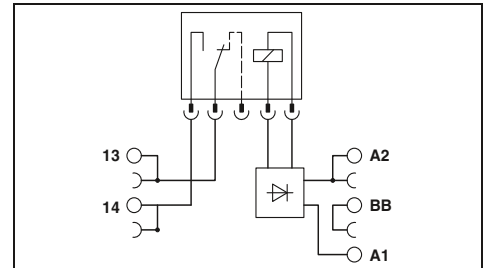

Technical data

Input data	①	②	③
Permissible range (with reference to U_N)	See diagram		
Switching level (with reference to U_N)	1 signal ("H") 0 signal ("L")		
Typ. input current at U_N	[mA]	9	3.5 3.2
Typ. response time/switch-on time at U_N	[ms]	5	6 7
Typ. release time/switch-off time at U_N	[ms]	8	15 15
Transmission frequency f_{limit}	[Hz]		
Input circuit DC			
Input circuit AC/DC			
Output data			
Contact material	AgSnO, hard gold-plated		
Max. switching voltage	30 V AC / 36 V DC		
Min. switching voltage	100 mV (at 10 mA)		
Limiting continuous current	50 mA		
Max. inrush current	50 mA		
Min. switching current	1 mA (at 24 V)		
Output protection	-		
Voltage drop at max. limiting continuous current	-		
General data			
Test voltage input/output	4 kV AC (50 Hz, 1 min.)		
Ambient temperature (operation)	-40°C ... 60°C ¹⁾		
Mechanical service life	2 x 10 ⁷ cycles		
Standards/regulations	IEC 60664, EN 50178, IEC 62103		
Pollution degree/surge voltage category	3 / III		
Connection data solid / stranded / AWG	0.14 - 2.5 mm ² / 0.14 - 2.5 mm ² / 26 - 14		
Dimensions	W / H / D 6.2 mm / 80 mm / 94 mm		

①	②	③
See diagram		
Yellow LED, Protection against polarity reversal, freewheeling diode		
Yellow LED, Bridge rectifier		

Ordering data

Description	Input voltage U_N
PLC INTERFACE, with screw connection	
①	24 V DC
②	120 V AC (110 V DC)
③	230 V AC (220 V DC)
PLC INTERFACE, with spring-cage connection	
①	24 V DC
②	120 V AC (110 V DC)
③	230 V AC (220 V DC)
PLC-INTERFACE, with push-in connection	
①	24 V DC
②	120 V AC (110 V DC)
③	230 V AC (220 V DC)

Type	Order No.	Pcs. / Pkt.
PLC-RSC- 24DC/ 1AU/SEN ²⁾	2966317	10
PLC-RSC-120UC/ 1AU/SEN ²⁾	2966320	10
PLC-RSC-230UC/ 1AU/SEN ²⁾	2966333	10
PLC-RSP- 24DC/ 1AU/SEN ²⁾	2967374	10
PLC-RSP-120UC/ 1AU/SEN ²⁾	2967390	10
PLC-RSP-230UC/ 1AU/SEN ²⁾	2967413	10
PLC-RPT- 24DC/ 1AU/SEN ²⁾	2900313	10
PLC-RPT-120UC/ 1AU/SEN ²⁾	2900314	10
PLC-RPT-230UC/ 1AU/SEN ²⁾	2900315	10

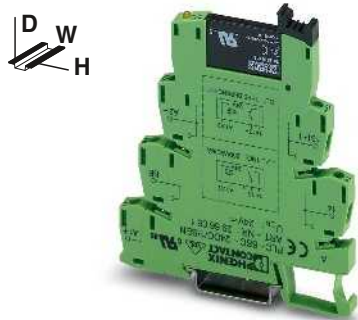

Max. DC voltage output of 100 mA

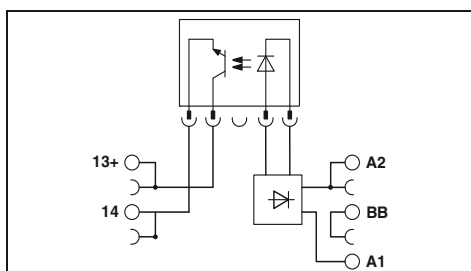

Technical data

①	②	③
0.8 - 1.2	0.8 - 1.1	0.8 - 1.1
≥ 0.8	≥ 0.8	≥ 0.8
≤ 0.4	≤ 0.3	≤ 0.3
8.5	3.5	3.5
0.02	6	3
0.3	10	5
300	10	10

Yellow LED, Protection against polarity reversal, freewheeling diode
 Yellow LED, Bridge rectifier

-
 48 V DC
 3 V DC
 100 mA
 -
 -
 Protection against polarity reversal, Surge protection
 ≤ 1 V

2.5 kV (50 Hz, 1 min.)
 -25°C ... 60°C

-
 IEC 60664, EN 50178, IEC 62103
 2 / III
 0.14 - 2.5 mm² / 0.14 - 2.5 mm² / 26 - 14
 6.2 mm / 80 mm / 94 mm

Ordering data

Type	Order No.	Pcs. / Pkt.
PLC-OSC- 24DC/ 48DC/100/SEN ²)	2966773	10
PLC-OSC-120UC/ 48DC/100/SEN ²)	2966799	10
PLC-OSC-230UC/ 48DC/100/SEN ²)	2966809	10
PLC-OSP- 24DC/ 48DC/100/SEN ²)	2967578	10
PLC-OSP-120UC/ 48DC/100/SEN ²)	2967581	10
PLC-OSP-230UC/ 48DC/100/SEN ²)	2967594	10
PLC-OPT- 24DC/ 48DC/100/SEN ²)	2900358	10
PLC-OPT-120UC/ 48DC/100/SEN ²)	2900359	10
PLC-OPT-230UC/ 48DC/100/SEN ²)	2900361	10

Relay modules

PLC series

PLC-INTERFACE for high inrush currents

PLC relay modules for high inrush currents due, for example, to capacitive loads

The advantages:

- Max. inrush current of 130 A
- Direct connection of load return line thanks to actuator type
- Screw, spring-cage, and push-in technology
- Safe isolation according to DIN EN 50178 between coil and contact
- Functional plug-in bridges
- Efficient connection to system cabling using V8 adapter

Notes:
Type of housing: Polyamide PA non-reinforced, color: green.
Marking systems and mounting material See Catalog 5
Separating plate PLC-ATP must be installed for voltages larger than 250 V (L1, L2, L3) between identical terminal blocks in adjacent modules. Potential bridging is then carried out with FBST 8-PLC... or FBST 500....
For diagrams of operating voltage ranges, see page 343
1) EMC: Class A product, see page 571



1 N/O contact of up to 130 A peak

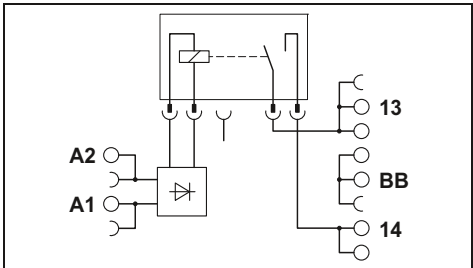

Technical data

Input data	
Typ. input current at U_N	[mA]
Response/release time at U_N	[ms]
Input circuit DC	
Output data	
Contact material	
Max. switching voltage	
Min. switching voltage	
Max. inrush current	
General data	
Test voltage input/output	
Ambient temperature (operation)	
Mechanical service life	
Standards/regulations	
Connection data solid / stranded / AWG	
Dimensions	W / H / D

①	18
	8 / 10
	Yellow LED, Protection against polarity reversal, freewheeling diode
	AgSnO
	250 V AC/DC
	12 V AC/DC (at 100 mA)
	80 A (for 20 ms) / 130 A (peak, at capacitive load, 230 V AC, 24 μF)
	4 kV AC (50 Hz, 1 min.)
	-40°C ... 60°C
	3 x 10 ⁷ cycles
	IEC 60664, EN 50178, IEC 62103
	0.14 - 2.5 mm ² / 0.14 - 2.5 mm ² / 26 - 14
	14 mm / 80 mm / 94 mm

Basic behavior of capacitive loads:

- Very high input current
- Voltage increases with an e-function

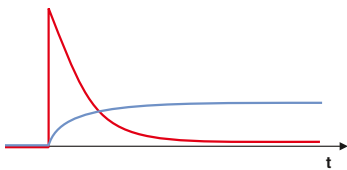

Max. interrupting rating

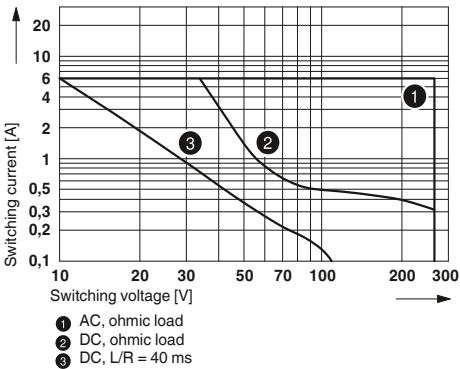

Ordering data

Description	Input voltage U_N
PLC INTERFACE, with screw connection ①	24 V DC
PLC INTERFACE, with spring-cage connection ①	24 V DC
PLC-INTERFACE, with push-in connection ①	24 V DC

Type	Order No.	Pcs. / Pkt.
PLC-RSC- 24DC/ 1IC/ACT ¹)	2967604	10
PLC-RSP- 24DC/ 1IC/ACT ¹)	2912413	10
PLC-RPT- 24DC/ 1IC/ACT ¹)	2900298	10

PLC-INTERFACE for high continuous currents

PLC relay modules for high continuous switching currents

- The advantages:
- Max. continuous current of 10 A
 - Safe isolation according to DIN EN 50178 between coil and contact
 - Screw, spring-cage, and push-in technology
 - Functional plug-in bridges
 - Efficient connection to system cabling using V8 adapter
 - Long electrical service life thanks to 16 A relay
 - All common input voltages of 12 V DC to 230 V AC

Notes:	
Type of housing:	Polyamide PA non-reinforced, color: green.
Marking systems and mounting material	See Catalog 5
Separating plate PLC-ATP must be installed for voltages larger than 250 V (L1, L2, L3) between identical terminal blocks in adjacent modules. Potential bridging is then carried out with FBST 8-PLC... or FBST 500....	
For diagrams of operating voltage ranges, see page 343	
*) 230 V types up to 55°C	
2) EMC: Class A product, see page 571	



1 PDT up to 10 A

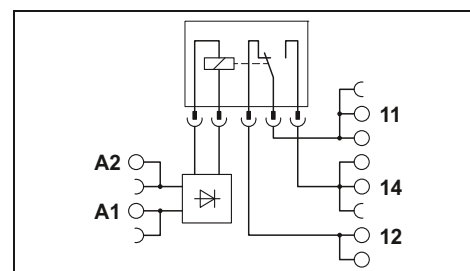

Input data	
Typ. input current at U_N	[mA]
Response/release time at U_N	[ms]
Input circuit DC	
Input circuit AC/DC	
Output data	
Contact material	AgNi
Max. switching voltage	250 V AC/DC
Min. switching voltage	12 V AC/DC
Limiting continuous current	10 A
Max. inrush current	30 A (300 ms)
Min. switching current	100 mA
General data	
Test voltage input/output	4 kV AC (50 Hz, 1 min.)
Ambient temperature (operation)	-40°C ... 60°C ¹⁾
Mechanical service life	3 x 10 ⁷ cycles
Standards/regulations	IEC 60664, EN 50178, IEC 62103
Connection data solid / stranded / AWG	0.14 - 2.5 mm ² / 0.14 - 2.5 mm ² / 26 - 14
Dimensions	W / H / D

Technical data						
①	②	③	④	⑤	⑥	⑦
33	18	17.5	20	10	4.5	4.5
8 / 10	8 / 10	8 / 10	8 / 10	8 / 10	7 / 10	7 / 10
Yellow LED, Protection against polarity reversal, freewheeling diode						
Yellow LED, Bridge rectifier						

Description	Input voltage U_N
PLC INTERFACE, with screw connection	
①	12 V DC
②	24 V DC
③	24 V AC/DC
④	48 V DC
⑤	60 V DC
⑥	120 V AC (110 V DC)
⑦	230 V AC (220 V DC)
PLC INTERFACE, with spring-cage connection	
①	12 V DC
②	24 V DC
③	24 V AC/DC
④	48 V DC
⑤	60 V DC
⑥	120 V AC (110 V DC)
⑦	230 V AC (220 V DC)
PLC-INTERFACE, with push-in connection	
①	12 V DC
②	24 V DC
③	24 V AC/DC
④	48 V DC
⑤	60 V DC
⑥	120 V AC (110 V DC)
⑦	230 V AC (220 V DC)

Ordering data			
Type	Order No.	Pcs. / Pkt.	
PLC-RSC- 12DC/21HC ²⁾	2967617	10	
PLC-RSC- 24DC/21HC ²⁾	2967620	10	
PLC-RSC- 24UC/21HC ²⁾	2967633	10	
PLC-RSC- 48DC/21HC ²⁾	2967646	10	
PLC-RSC- 60DC/21HC ²⁾	2967659	10	
PLC-RSC-120UC/21HC ²⁾	2967662	10	
PLC-RSC-230UC/21HC ²⁾	2967675	10	
PLC INTERFACE, with spring-cage connection			
PLC-RSP- 12DC/21HC ²⁾	2912264	10	
PLC-RSP- 24DC/21HC ²⁾	2912277	10	
PLC-RSP- 24UC/21HC ²⁾	2912280	10	
PLC-RSP- 48DC/21HC ²⁾	2912293	10	
PLC-RSP- 60DC/21HC ²⁾	2912303	10	
PLC-RSP-120UC/21HC ²⁾	2912316	10	
PLC-RSP-230UC/21HC ²⁾	2912329	10	
PLC-INTERFACE, with push-in connection			
PLC-RPT- 12DC/21HC ²⁾	2900290	10	
PLC-RPT- 24DC/21HC ²⁾	2900291	10	
PLC-RPT- 24UC/21HC ²⁾	2900293	10	
PLC-RPT- 48DC/21HC ²⁾	2900294	10	
PLC-RPT- 60DC/21HC ²⁾	2900295	10	
PLC-RPT-120UC/21HC ²⁾	2900296	10	
PLC-RPT-230UC/21HC ²⁾	2900297	10	

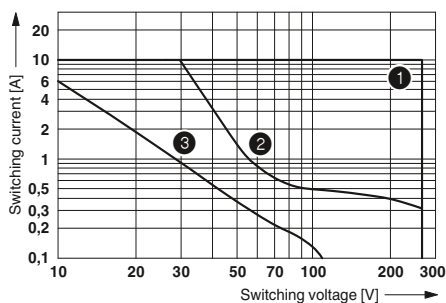

① AC, ohmic load
② DC, ohmic load
③ DC, L/R = 40 ms

Max. interrupting rating

Basic terminal blocks with interference current filter that can be fitted with relays

PLC basic terminal blocks with integrated filter to protect against interference voltages or currents due, for example, to long control lines

The advantages:

- Resistant to interference currents
- High relay release voltage

Typical applications:

- Applications with long control lines
- Use of AC output boards, resulting in residual AC currents
- Screw, spring-cage, and push-in technology

Notes:
Type of housing: Polyamide PA non-reinforced, color: green.
Marking systems and mounting material See Catalog 5
Separating plate PLC-ATP must be installed for voltages larger than 250 V (L1, L2, L3) between identical terminal blocks in adjacent modules. Potential bridging is then carried out with FBST 8-PLC... or FBST 500....
For diagrams of operating voltage ranges, see page 343
Maximum interrupting rating diagrams, see page 346
1) EMC: Class A product, see page 571



Universal design

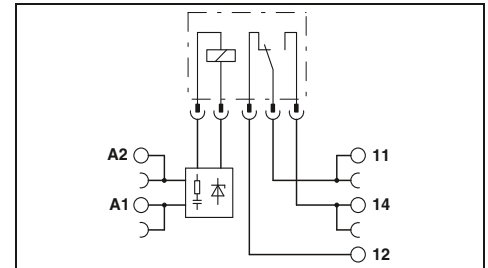

Input data
Nominal input voltage U_N
Permissible range (with reference to U_N)
Typ. release voltage (with relay)
Typ. input current with U_N (50/60 Hz)
Typ. response time at U_N
Typ. release time at U_N
Input circuit
Output data with:
Contact type
Contact material
Max. switching voltage
Min. switching voltage
Limiting continuous current
Max. inrush current
Min. switching current
General data
Test voltage input/output
Ambient temperature (operation)
Mechanical service life
Standards/regulations
Pollution degree / Surge voltage category
Connection data solid / stranded / AWG
Dimensions

Technical data	
120 V AC	230 V AC
0.8 ... 1.4	0.78 ... 1.14
50 V AC	80 V AC
7 mA / 8 mA	8.8 mA / 10 mA
7 ms	7 ms
20 ms	20 ms
Yellow LED, Bridge rectifier, Filter	
REL-MR-60DC/21	REL-MR-60DC/21AU
Single contact, 1-PDT	Single contact, 1-PDT
AgSnO	AgSnO, hard gold-plated
250 V AC/DC	30 V AC / 36 V DC
5 V (at 100 mA)	100 mV (at 10 mA)
6 A	50 mA
(on request)	50 mA
10 mA (at 12 V)	1 mA (at 24 V)
4 kV (50 Hz, 1 min.)	
-20°C ... 55°C	
2 x 10 ⁷ cycles	
IEC 60664, EN 50178, IEC 62103	
3 / III	
0.14 - 2.5 mm ² / 0.14 - 2.5 mm ² / 26 - 14	
6.2 mm / 80 mm / 94 mm	

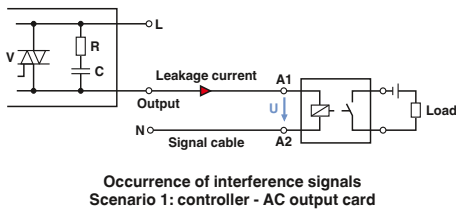

Description	Voltage U_N
PLC-INTERFACE basic terminal block , for plug-in miniature relays or solid-state relays	
With screw connection	120 V AC
With screw connection	230 V AC
With spring-cage connection	120 V AC
With spring-cage connection	230 V AC
With push-in connection	120 V AC
With push-in connection	230 V AC

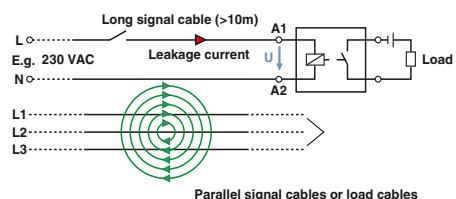

Plug-in miniature relays
with gold contact
with power contact

Ordering data			
Type	Order No.	Pcs. / Pkt.	
PLC-BSC-120UC/21/SO46 ¹⁾	2980319	10	
PLC-BSC-230UC/21/SO46 ¹⁾	2980335	10	
PLC-BSP-120UC/21/SO46 ¹⁾	2980351	10	
PLC-BSP-230UC/21/SO46 ¹⁾	2980377	10	
PLC-BPT-120UC/21/SO46 ¹⁾	2900453	10	
PLC-BPT-230UC/21/SO46 ¹⁾	2900455	10	

Accessories		
REL-MR- 60DC/21AU	2961134	10
REL-MR- 60DC/21	2961118	10

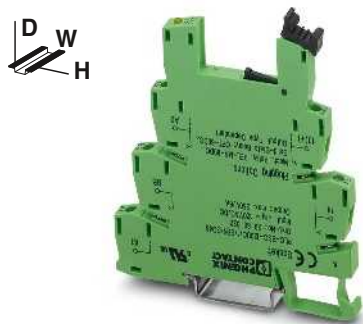

Sensor design

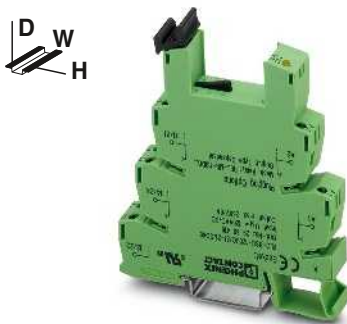

2 PDT universal design

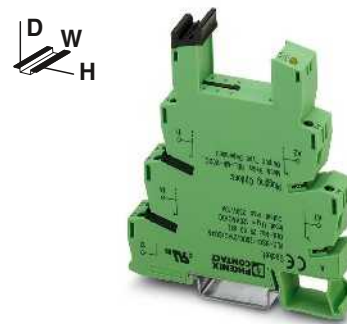

1 PDT for high continuous currents

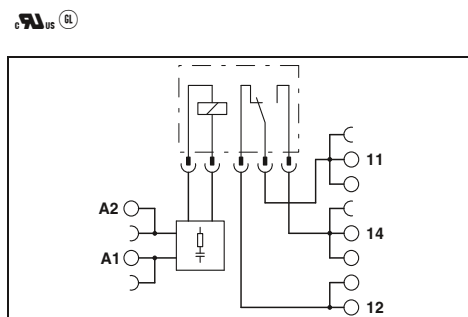
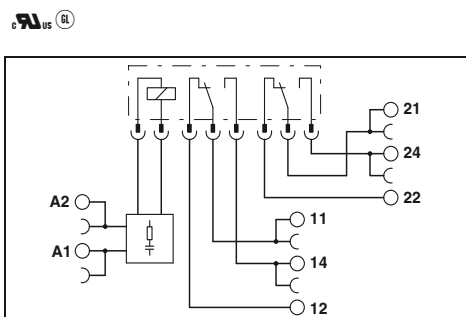
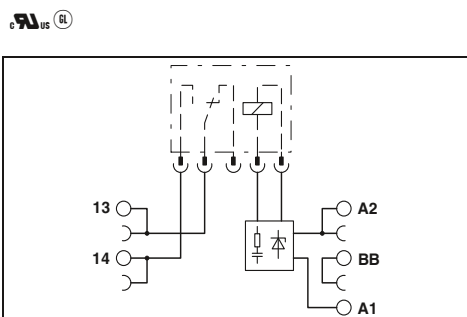

Technical data

120 V AC	230 V AC
0.8 ... 1.4	0.78 ... 1.14
50 V AC	80 V AC
7 mA / 8 mA	8.8 mA / 10 mA
7 ms	7 ms
20 ms	20 ms
Yellow LED, Bridge rectifier, Filter	
REL-MR-60DC/21	REL-MR-60DC/21AU
Single contact, 1 N/O contact	Single contact, 1 N/O contact
AgSnO	AgSnO, hard gold-plated
250 V AC/DC	30 V AC / 36 V DC
5 V (at 100 mA)	100 mV (at 10 mA)
6 A	50 mA
(on request)	50 mA
10 mA (at 12 V)	1 mA (at 24 V)
4 kV (50 Hz, 1 min.)	
-20°C ... 55°C	
2 x 10 ⁷ cycles	
IEC 60664, EN 50178, IEC 62103	
3 / III	
0.14 - 2.5 mm ² / 0.14 - 2.5 mm ² / 26 - 14	
6.2 mm / 80 mm / 94 mm	

Technical data

120 V AC	230 V AC
0.78 ... 1.4	0.78 ... 1.14
16 V AC	70 V AC
6 mA / 7 mA	8.5 mA / 10 mA
7 ms	7 ms
10 ms	10 ms
Yellow LED, Bridge rectifier, Filter	
REL-MR-110DC/21-21	REL-MR-110DC/21-21AU
Single contact, 2-PDT	Single contact, 2-PDT
AgNi	AgNi, + 5 µm Au
250 V AC/DC	30 V AC / 36 V DC
5 V AC/DC	100 mV
6 A	50 mA
15 A (300 ms)	50 mA
10 mA	1 mA
4 kV (50 Hz, 1 min.)	
-20°C ... 55°C	
3 x 10 ⁷ cycles	
IEC 60664, EN 50178, IEC 62103	
3 / III	
0.14 - 2.5 mm ² / 0.14 - 2.5 mm ² / 26 - 14	
14 mm / 80 mm / 94 mm	

Technical data

120 V AC	230 V AC
0.85 ... 1.4	0.78 ... 1.14
16 V AC	70 V AC
6 mA / 7 mA	8.5 mA / 10 mA
7 ms	7 ms
20 ms	20 ms
Yellow LED, Bridge rectifier, Filter	
REL-MR-110DC/21HC	REL-MR-110DC/21HC
Single contact, 1-PDT	Single contact, 1-PDT
AgNi	AgNi
250 V AC/DC	30 V AC / 36 V DC
12 V AC/DC	100 mV
10 A	50 mA
30 A (300 ms)	50 mA
100 mA	1 mA
4 kV (50 Hz, 1 min.)	
-20°C ... 55°C	
3 x 10 ⁷ cycles	
IEC 60664, EN 50178, IEC 62103	
3 / III	
0.14 - 2.5 mm ² / 0.14 - 2.5 mm ² / 26 - 14	
14 mm / 80 mm / 94 mm	

Ordering data

Type	Order No.	Pcs. / Pkt.
PLC-BSC-120UC/ 1/SEN/SO46 ¹⁾	2980322	10
PLC-BSC-230UC/ 1/SEN/SO46 ¹⁾	2980348	10
PLC-BSP-120UC/ 1/SEN/SO46 ¹⁾	2980364	10
PLC-BSP-230UC/ 1/SEN/SO46 ¹⁾	2980380	10
PLC-BPT-120UC/ 1/SEN/SO46 ¹⁾	2900456	10
PLC-BPT-230UC/ 1/SEN/SO46 ¹⁾	2900457	10

Ordering data

Type	Order No.	Pcs. / Pkt.
PLC-BSC-120UC/21-21/SO46 ¹⁾	2980416	10
PLC-BSC-230UC/21-21/SO46 ¹⁾	2980429	10

Ordering data

Type	Order No.	Pcs. / Pkt.
PLC-BSC-120UC/21HC/SO46 ¹⁾	2980432	10
PLC-BSC-230UC/21HC/SO46 ¹⁾	2980445	10

Accessories

REL-MR- 60DC/21AU	2961134	10
REL-MR- 60DC/21	2961118	10

Accessories

REL-MR-110DC/21-21AU	2961228	10
REL-MR-110DC/21-21	2961202	10

Accessories

REL-MR-110DC/21HC	2961338	10
-------------------	---------	----

Relay modules

PLC series

Basic terminal blocks with interference current filter that can be fitted with solid-state relays

PLC basic terminal blocks with integrated filter to protect against interference voltages or currents due, for example, to long control lines

The advantages:

- Resistant to interference currents
- High relay release voltage

Typical applications:

- Applications with long control lines
- Use of AC output boards, resulting in residual AC currents
- Screw, spring-cage, and push-in technology

Notes:
Type of housing: Polyamide PA non-reinforced, color: green.
Marking systems and mounting material See Catalog 5
Separating plate PLC-ATP must be installed for voltages larger than 250 V (L1, L2, L3) between identical terminal blocks in adjacent modules. Potential bridging is then carried out with FBST 8-PLC... or FBST 500....
For derating curves see page 345
1) EMC: Class A product, see page 571



Universal design

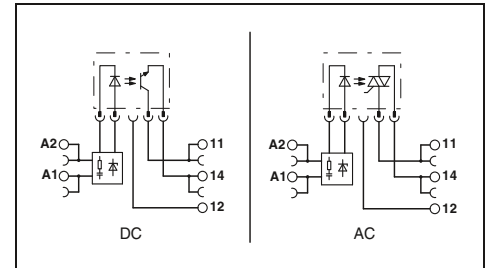

Input data
Nominal input voltage U_N
Permissible range (with reference to U_N)
Switching level (with optocoupler) 0 signal ("L")
Typ. input current with U_N (50 / 60 Hz)
Typ. response time/switch-on time at U_N
Typ. switch-off time at U_N
Input circuit
Output data with:
Max. switching voltage
Min. switching voltage
Limiting continuous current
Max. inrush current
Output protection
Voltage drop at limiting continuous current
Leakage current in off state
Max. phase shift (inductive consumer)
Max. load value $I^2 \times t$ ($t = 10$ ms)
General data
Test voltage input/output
Ambient temperature (operation)
Standards/regulations
Pollution degree / Surge voltage category
Connection data solid / stranded / AWG
Dimensions

Technical data		
120 V AC	230 V AC	
0.85 ... 1.1	0.8 ... 1.1	
≤ 0.4	≤ 0.4	
7 mA / 8 mA	8.8 mA / 10 mA	
6 ms	6 ms	
10 ms	10 ms	
Yellow LED, Bridge rectifier, Filter		
OPT...48DC/...	OPT...24DC/...	OPT...230AC/...
48 V DC	30 V DC	253 V AC
3 V DC	3 V DC	24 V AC
100 mA	3 A	0.75 A
	15 A (10 ms)	30 A (10 ms)
Protection against polarity reversal, Surge protection	Protection against polarity reversal, Surge protection	RCV circuit
< 1 V DC	< 200 mV	< 1 V AC
-	-	< 1 mA
-	-	0.5
-	-	4.5 A ² s
2.5 kV (50 Hz, 1 min.)		
-20°C ... 55°C		
IEC 60664, EN 50178, IEC 62103		
2 / III		
0.14 - 2.5 mm ² / 0.14 - 2.5 mm ² / 26 - 14		
6.2 mm / 80 mm / 94 mm		

Description	Voltage U_N
PLC-INTERFACE basic terminal block , for plug-in miniature relays or solid-state relays	
With screw connection	120 V AC
With screw connection	230 V AC
With spring-cage connection	120 V AC
With spring-cage connection	230 V AC
With push-in connection	120 V AC
With push-in connection	230 V AC

Ordering data			
Type	Order No.	Pcs. / Pkt.	
PLC-BSC-120UC/21/SO46 ¹	2980319	10	
PLC-BSC-230UC/21/SO46 ¹	2980335	10	
PLC-BSP-120UC/21/SO46 ¹	2980351	10	
PLC-BSP-230UC/21/SO46 ¹	2980377	10	
PLC-BPT-120UC/21/SO46 ¹	2900453	10	
PLC-BPT-230UC/21/SO46 ¹	2900455	10	

Plug-in solid-state relays	
Solid-state input relays	
Solid-state power relays	
Solid-state power relays	

Accessories		
OPT-60DC/ 48DC/100	2966621	10
OPT-60DC/ 24DC/ 2	2966605	10
OPT-60DC/230AC/ 1	2967963	10



Sensor design

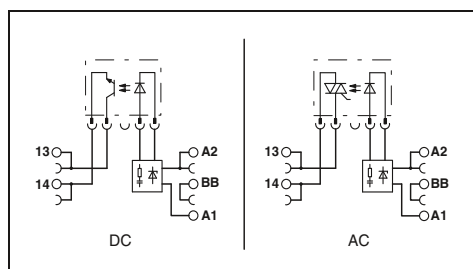

Technical data

120 V AC	230 V AC
0.85 ... 1.1	0.8 ... 1.1
≤ 0.4	≤ 0.4
7 mA / 8 mA	8.8 mA / 10 mA
6 ms	6 ms
10 ms	10 ms
Yellow LED, Bridge rectifier, Filter	
OPT...48DC/...	OPT...24DC/...
48 V DC	30 V DC
3 V DC	3 V DC
100 mA	3 A
	15 A (10 ms)
Protection against polarity reversal, Surge protection	Protection against polarity reversal, Surge protection
< 1 V	< 200 mV
-	-
-	0.5
-	4.5 A²s

2.5 kV (50 Hz, 1 min.)
 -20°C ... 55°C
 IEC 60664, EN 50178, IEC 62103
 2 / III
 0.14 - 2.5 mm² / 0.14 - 2.5 mm² / 26 - 14
 6.2 mm / 80 mm / 94 mm

Ordering data

Type	Order No.	Pcs. / Pkt.
PLC-BSC-120UC/ 1/SEN/SO46 ¹⁾	2980322	10
PLC-BSC-230UC/ 1/SEN/SO46 ¹⁾	2980348	10
PLC-BSP-120UC/ 1/SEN/SO46 ¹⁾	2980364	10
PLC-BSP-230UC/ 1/SEN/SO46 ¹⁾	2980380	10
PLC-BPT-120UC/ 1/SEN/SO46 ¹⁾	2900456	10
PLC-BPT-230UC/ 1/SEN/SO46 ¹⁾	2900457	10

Accessories

OPT-60DC/ 48DC/100	2966621	10
OPT-60DC/ 24DC/ 2	2966605	10
OPT-60DC/230AC/ 1	2967963	10

Plug-in miniature power relays

Plug-in miniature power relays suitable for PLC-INTERFACE and RIF-0, RIF-1, and PR1 relay bases.

The advantages:

- Power contacts up to 16 A
- Multi-layer gold contact or power contact
- High degree of protection up to RT III (comparable with IP67) depending on type
- Safe isolation according to DIN EN 50178 between coil and contact

Notes:
If the specified maximum values for multi-layer contact relays are exceeded, the gold plating is destroyed. The maximum values of the power contact relay are then valid. This can result in a shorter service life than with a pure power contact.
For dimensional drawings and perforations for assembly, see page 344
For diagrams of operating voltage ranges, see page 343



1 PDT

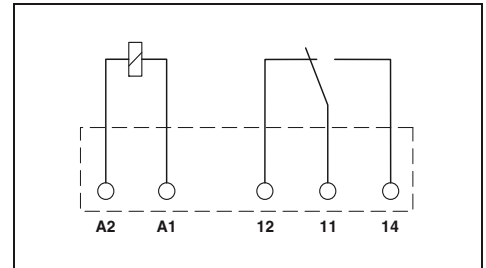

Input data		Technical data				
Permissible range (with reference to U_N)		①	②	③	④	⑤
Typ. input current at U_N	[mA]	refer to the diagram				
Typ. response time at U_N	[ms]	38	14	9	7	3
Typ. release time at U_N	[ms]	5	5	5	5	5
Output data		2.5	2.5	2.5	2.5	2.5
Contact type		Single contact, 1-PDT			Single contact, 1-PDT	
Contact material		AgSnO			AgSnO, hard gold-plated	
Max. switching voltage		250 V AC/DC			30 V AC / 36 V DC	
Min. switching voltage		5 V (at 100 mA)			100 mV (at 10 mA)	
Limiting continuous current		6 A			50 mA	
Max. inrush current		(on request)			(on request)	
Min. switching current		10 mA (at 12 V)			1 mA (at 24 V)	
Max. interrupting rating, ohmic load		24 V DC	140 W			1.2 W
		48 V DC	20 W			-
		60 V DC	18 W			-
		110 V DC	23 W			-
		220 V DC	40 W			-
		250 V AC	1500 VA			-
General data		4 kV AC (50 Hz, 1 min.)				
Test voltage (winding / contact)		-40°C ... 85°C				
Ambient temperature (operation)		100% operating factor				
Nominal operating mode		2 x 10 ⁷ cycles				
Mechanical service life		IEC 60664, EN 50178, IEC 62103				
Standards/regulations		Any / In rows with zero spacing				
Mounting position/mounting		Dimensions				
		W / H / D		5 mm / 28 mm / 15 mm		

Ordering data	
Description	Input voltage U_N
Plug-in miniature power relays	
with power contact	① 4.5 V DC
with power contact	② 12 V DC
with power contact	③ 18 V DC
with power contact	④ 24 V DC
with power contact	⑤ 60 V DC
with power contact	⑥ 110 V DC
Plug-in miniature power relays	
with gold contact	① 4.5 V DC
with gold contact	② 12 V DC
with gold contact	③ 18 V DC
with gold contact	④ 24 V DC
with gold contact	⑤ 60 V DC
with gold contact	⑥ 110 V DC

Type	Order No.	Pcs. / Pkt.
REL-MR- 4,5DC/21	2961367	10
REL-MR- 12DC/21	2961150	10
REL-MR- 18DC/21	2961383	10
REL-MR- 24DC/21	2961105	10
REL-MR- 60DC/21	2961118	10
REL-MR 4,5DC/21AU	2961370	10
REL-MR- 12DC/21AU	2961163	10
REL-MR- 18DC/21AU	2961493	10
REL-MR- 24DC/21AU	2961121	10
REL-MR- 60DC/21AU	2961134	10



2 PDT



1 N/O contact, for high inrush currents



1 PDT for high continuous currents

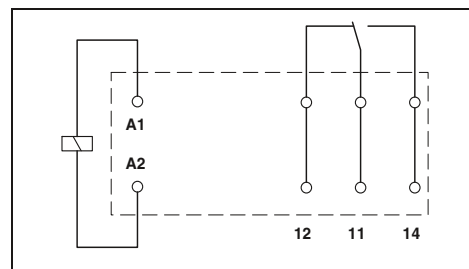
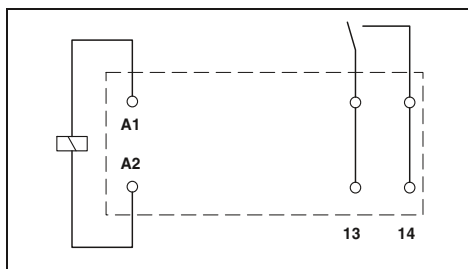
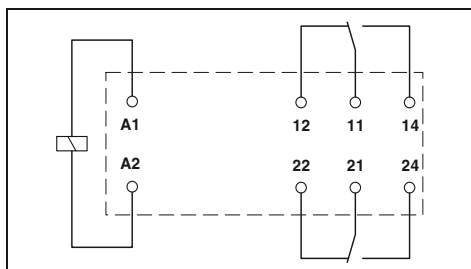

Technical data

Technical data

Technical data

②	④	⑤	⑥
refer to the diagram			
33	17	8.2	4.1
7	7	7	7
3	3	3	3

④
refer to the diagram
17
8
3

②	④	⑤	⑥
refer to the diagram			
33	17	8.2	4.1
7	7	7	7
3	3	3	3

Single contact, 2-PDT

Single contact, 1 N/O contact

Single contact, 1-PDT

AgNi
250 V AC/DC
5 V (at 10 mA)
8 A
25 A (20 ms)
10 mA (At 5 V)

AgSnO
250 V AC/DC
12 V (at 100 mA)
16 A
80 A (20 ms)
100 mA (at 12 V DC)

AgNi
250 V AC/DC
12 V (at 10 mA)
16 A
30 A (300 ms)
100 mA

190 W
85 W
60 W
44 W
60 W
2000 VA

384 W
58 W
48 W
50 W
80 W
4000 VA

384 W
58 W
48 W
50 W
80 W
4000 VA

5 kV AC (50 Hz, 1 min.)
-40°C ... 85°C
100% operating factor
3 x 10⁷ cycles
IEC 60664, EN 50178, IEC 62103
Any / Can be aligned without spacing (> 70°C ≥ 2.5 mm)

5 kV AC (50 Hz, 1 min.)
-40°C ... 85°C
100% operating factor
3 x 10⁷ cycles
IEC 60664, EN 50178, IEC 62103
Any / Can be aligned without spacing (> 70°C ≥ 2.5 mm)

5 kV AC (50 Hz, 1 min.)
-40°C ... 85°C
100% operating factor
3 x 10⁷ cycles
IEC 60664, EN 50178, IEC 62103
Any / Can be aligned without spacing (> 70°C ≥ 2.5 mm)

12.7 mm / 29 mm / 15.7 mm

12.7 mm / 29 mm / 15.7 mm

12.7 mm / 29 mm / 15.7 mm

Ordering data

Ordering data

Ordering data

Type	Order No.	Pcs. / Pkt.
REL-MR- 12DC/21-21	2961257	10
REL-MR- 24DC/21-21	2961192	10
REL-MR- 60DC/21-21	2961273	10
REL-MR-110DC/21-21	2961202	10
REL-MR- 12DC/21-21AU	2961299	10
REL-MR- 24DC/21-21AU	2961215	10
REL-MR- 60DC/21-21AU	2961286	10
REL-MR-110DC/21-21AU	2961228	10

Type	Order No.	Pcs. / Pkt.
REL-MR- 24DC/11C	2961341	10

Type	Order No.	Pcs. / Pkt.
REL-MR- 12DC/21HC	2961309	10
REL-MR- 24DC/21HC	2961312	10
REL-MR- 60DC/21HC	2961325	10
REL-MR-110DC/21HC	2961338	10

Plug-in solid-state relays

Plug-in solid-state relays suitable for PLC-INTERFACE and RIF-0, RIF-1, and PR1 relay bases.

The advantages:

- Switching capacity of up to 24 V DC/5 A
- RT III wash tight (comparable to IP67)
- Vibration- and shock-resistant
- Wear-free and long-lasting
- Zero voltage switch at AC output
- Can be soldered in on PCB



Max. DC voltage output of 3 A



Max. DC voltage output of 100 mA

Notes:

For dimensional drawings and perforations for assembly, see page 345

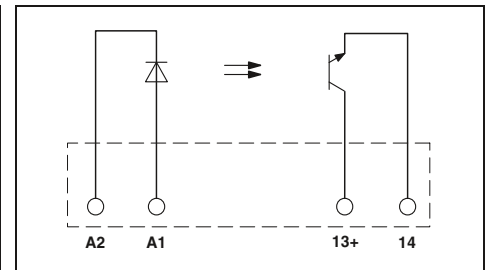
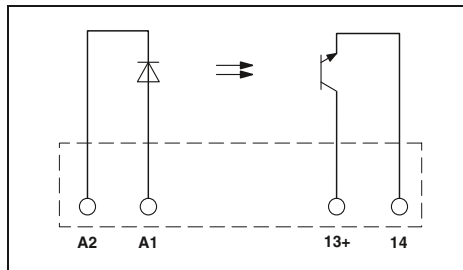

Technical data

Technical data

Input data	
Permissible range (with reference to U_N)	
Switching level	1 signal ("H") [V DC] \geq 0 signal ("L") [V DC] \leq
Typ. input current at U_N	[mA]
Typ. switch-on time at U_N	[μ s]
Typ. switch-off time at U_N	[μ s]
Transmission frequency f_{emit}	[Hz]
Output data	
Max. switching voltage	33 V DC
Min. switching voltage	3 V DC
Limiting continuous current	3 A (see derating curve)
Min. load current	-
Max. inrush current	15 A (10 ms)
Leakage current in off state	-
Phase angle (cos ϕ)	-
Output circuit	2-conductor, floating
Max. load value	-
Output protection	Protection against polarity reversal, Surge protection
Voltage drop at max. limiting continuous current	\leq 150 mV
General data	
Rated surge voltage	Basic insulation
Test voltage input/output	2.5 kV (50 Hz, 1 min.)
Ambient temperature (operation)	-25°C ... 60°C
Nominal operating mode	100% operating factor
Standards/regulations	IEC 60664, EN 50178, IEC 62103
Pollution degree/surge voltage category	2 / III
Mounting position/mounting	Any / In rows with zero spacing
Dimensions	5 mm / 28 mm / 15 mm

①	②	③
0.8 - 1.2	0.8 - 1.2	0.8 - 1.2
2.5	16	35
0.8	10	20
9	7	3
20	20	40
300	300	500
300	300	300
33 V DC		
3 V DC		
3 A (see derating curve)		
-		
15 A (10 ms)		
-		
-		
-		
2-conductor, floating		
-		
Protection against polarity reversal, Surge protection		
\leq 150 mV		
Basic insulation		
2.5 kV (50 Hz, 1 min.)		
-25°C ... 60°C		
100% operating factor		
IEC 60664, EN 50178, IEC 62103		
2 / III		
Any / In rows with zero spacing		
5 mm / 28 mm / 15 mm		

①	②	③
0.8 - 1.2	0.8 - 1.2	0.9 - 1.1
2.5	16	52
0.8	10	40
4	7	3
20	20	50
300	300	800
300	300	100
48 V DC		
3 V DC		
100 mA		
-		
-		
-		
2-conductor, floating		
-		
Protection against polarity reversal, Surge protection		
\leq 1 V		
Basic insulation		
2.5 kV (50 Hz, 1 min.)		
-25°C ... 60°C		
100% operating factor		
IEC 60664, EN 50178, IEC 62103		
2 / III		
Any / In rows with zero spacing		
5 mm / 28 mm / 15 mm		

Ordering data

Ordering data

Description	Input voltage U_N
Plug-in solid-state relays	
Solid-state power relays	① 5 V DC
Solid-state power relays	② 24 V DC
Solid-state power relays	③ 60 V DC
Plug-in solid-state relays	
Solid-state input relays	① 5 V DC
Solid-state input relays	② 24 V DC
Solid-state input relays	③ 60 V DC

Type	Order No.	Pcs. / Pkt.
OPT-5DC/ 24DC/ 2	2967989	10
OPT-24DC/ 24DC/ 2	2966595	10
OPT-60DC/ 24DC/ 2	2966605	10

Type	Order No.	Pcs. / Pkt.
OPT-5DC/ 48DC/100	2967992	10
OPT-24DC/ 48DC/100	2966618	10
OPT-60DC/ 48DC/100	2966621	10



Max. DC voltage output of 5 A

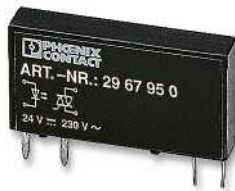

Max. AC voltage output of 750 mA



Max. AC voltage output of 2 mA

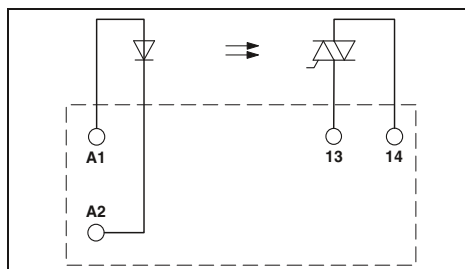
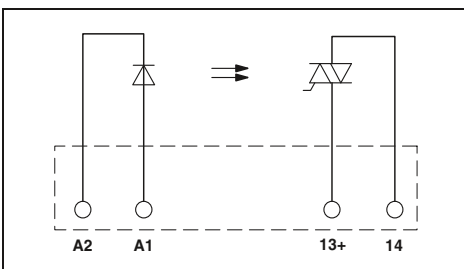
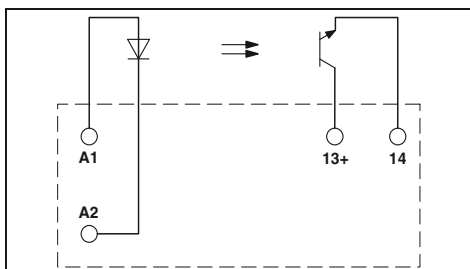

Technical data

①	②	③
0.8 -	0.8 -	0.9 -
1.2	1.2	1.1
2.5	16	35
0.8	10	20
9	7	3
10	20	25
400	400	400
300	300	300

33 V DC
 3 V DC
 5 A (see derating curve)
 -
 15 A (10 ms)
 -
 -
 2-conductor, floating
 -
 Protection against polarity reversal, Surge protection
 ≤ 200 mV

Basic insulation
 2.5 kV (50 Hz, 1 min.)
 -25°C ... 60°C
 100% operating factor
 IEC 60664, EN 50178, IEC 62103
 2 / III
 Any / In rows with zero spacing
 12.7 mm / 29 mm / 15.7 mm

Technical data

②	③
0.8 -	0.9 -
1.2	1.1
10	50
5	15
3	3
6000	9000
500	700
10	10

253 V AC
 24 V AC
 0.75 A (see derating curve)
 10 mA
 30 A (10 ms)
 < 1 mA
 0.5
 2-conductor floating, zero voltage switch
 4.5 A²s
 RCV circuit
 < 1 V

Basic insulation
 2.5 kV (50 Hz, 1 min.)
 -25°C ... 60°C
 100% operating factor
 IEC 60664, EN 50178, IEC 62103
 2 / III
 Any / In rows with zero spacing
 5 mm / 28 mm / 15 mm

Technical data

①	②	③
0.8 -	0.8 -	0.9 -
1.2	1.2	1.1
3	18	40
1	8.4	20
15	7	2.6
10000	10000	10000
10000	10000	10000
10	10	10

253 V AC
 24 V AC
 2 A (see derating curve)
 25 mA
 30 A (10 ms)
 < 1 mA
 -
 2-conductor floating, zero voltage switch
 4 A²s (tp = 10 ms, at 25°C)
 Surge protection
 ≤ 1 V

Basic insulation
 2.5 kV (50 Hz, 1 min.)
 -25°C ... 60°C
 100% operating factor
 IEC 60664
 2 / III
 Any / See derating curve
 12.7 mm / 29 mm / 15.7 mm

Ordering data

Type	Order No.	Pcs. / Pkt.
OPT- 5DC/ 24DC/ 5	2982113	10
OPT-24DC/ 24DC/ 5	2982100	10
OPT-60DC/ 24DC/ 5	2982126	10

Ordering data

Type	Order No.	Pcs. / Pkt.
OPT-24DC/230AC/ 1	2967950	10
OPT-60DC/230AC/ 1	2967963	10

Ordering data

Type	Order No.	Pcs. / Pkt.
OPT- 5DC/230AC/ 2	2982168	10
OPT-24DC/230AC/ 2	2982171	10
OPT-60DC/230AC/ 2	2982184	10

Relay modules

Tables, diagrams, dimensional drawings

Relay options for PLC basic terminal blocks

Relay and solid-state relay options	Push-in connection		Spring-cage connection		Screw connection	
	1 PDT basic terminal block					
	PLC-BPT-5DC/21	2900443	PLC-BSP-5DC/21	2980238	PLC-BSC-5DC/21	2980225
REL-MR-4,5DC/21		X				
REL-MR-4,5DC/21AU		X				
REL-MR-12DC/21			X			
REL-MR-12DC/21AU			X			
REL-MR-24DC/21			X	X		
REL-MR-24DC/21AU			X	X		
REL-MR-60DC/21					X	
REL-MR-60DC/21AU					X	
REL-MR-24DC/1IC					X	
REL-MR-18DC/21					X	
REL-MR-18DC/21AU					X	
REL-MR-12DC/21-21					X	
REL-MR-12DC/21-21AU					X	
REL-MR-24DC/21-21					X	
REL-MR-24DC/21-21AU					X	
REL-MR-60DC/21-21					X	
REL-MR-60DC/21-21AU					X	
REL-MR-110DC/21-21					X	
REL-MR-110DC/21-21AU					X	
REL-MR-12DC/21HC					X	
REL-MR-24DC/21HC					X	
REL-MR-60DC/21HC					X	
REL-MR-110DC/21HC					X	
OPT-24DC/230AC/1			X			
OPT-60DC/230AC/1			X			
OPT-5DC/24DC/2		X				
OPT-24DC/24DC/2			X			
OPT-60DC/24DC/2			X			
OPT-5DC/48DC/100		X				
OPT-24DC/48DC/100			X			
OPT-60DC/48DC/100			X			
OPT-24DC/24DC/5					X	
OPT-60DC/24DC/5					X	
OPT-24DC/230AC/2					X	
OPT-60DC/230AC/2					X	
PLC-BPT-12DC/21	2900282		PLC-BSP-12DC/21	2912426	PLC-BSC-12DC/21	2967251
PLC-BPT-24DC/21	2900283		PLC-BSP-24DC/21	2912439	PLC-BSC-24DC/21	2967015
PLC-BPT-24UC/21	2900284		PLC-BSP-24UC/21	2912442	PLC-BSC-24UC/21	2967028
PLC-BPT-48DC/21	2900285		PLC-BSP-48DC/21	2912455	PLC-BSC-48DC/21	2967264
PLC-BPT-60DC/21	2900286		PLC-BSP-60DC/21	2912468	PLC-BSC-60DC/21	2967316
PLC-BPT-120DC/21	2900287		PLC-BSP-120DC/21	2912471	PLC-BSC-120DC/21	2967031
PLC-BPT-230DC/21	2900288		PLC-BSP-230DC/21	2912484	PLC-BSC-230DC/21	2967044
PLC-BPT-12DC/21HC	2900253		PLC-BSP-12DC/21HC	2912332	PLC-BSC-12DC/21HC	2967769
PLC-BPT-24DC/21HC	2900254		PLC-BSP-24DC/21HC	2912345	PLC-BSC-24DC/21HC	2967772
PLC-BPT-24UC/21HC	2900255		PLC-BSP-24UC/21HC	2912358	PLC-BSC-24UC/21HC	2967785
PLC-BPT-48DC/21HC	2900256		PLC-BSP-48DC/21HC	2912361	PLC-BSC-48DC/21HC	2967798
PLC-BPT-60DC/21HC	2900257		PLC-BSP-60DC/21HC	2912374	PLC-BSC-60DC/21HC	2967808
PLC-BPT-120DC/21HC	2900258		PLC-BSP-120DC/21HC	2912387	PLC-BSC-120DC/21HC	2967811
PLC-BPT-230DC/21HC	2900259		PLC-BSP-230DC/21HC	2912390	PLC-BSC-230DC/21HC	2967824
PLC-BPT-24DC/1/SEN	2900262		PLC-BSP-24DC/1/SEN	2967206	PLC-BSC-24DC/1/SEN	2966061
PLC-BPT-120UC/1/SEN	2900451		PLC-BSP-120UC/1/SEN	2967154	PLC-BSC-120UC/1/SEN	2966074
PLC-BPT-230UC/1/SEN	2900452		PLC-BSP-230UC/1/SEN	2967170	PLC-BSC-230UC/1/SEN	2966087
PLC-BPT-5DC/1/ACT	2900448		PLC-BSP-5DC/1/ACT	2980254	PLC-BSC-5DC/1/ACT	2980241
PLC-BPT-24DC/1/ACT	2900449		PLC-BSP-24DC/1/ACT	2967196	PLC-BSC-24DC/1/ACT	2966068
PLC-BPT-24UC/1/ACT	2900450		PLC-BSP-24UC/1/ACT	2962809	PLC-BSC-24UC/1/ACT	2982799
PLC-BPT-24DC/2/IRW	2900261		PLC-BSP-24DC/2/IRW	2961396		
PLC-BPT-24DC/1/IC/ACT	2900260		PLC-BSP-24DC/1/IC/ACT	2912400	PLC-BSC-24DC/1/IC/ACT	2967837

Operating voltage ranges for PLC-INTERFACE, 6.2 mm versions, equipped with relay

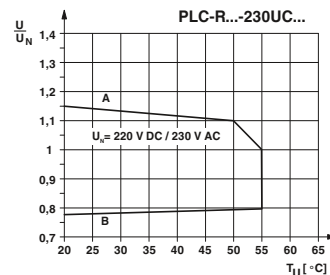
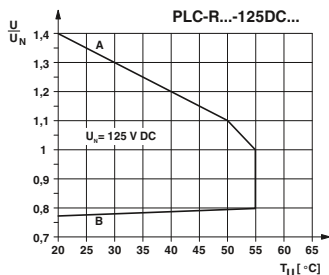
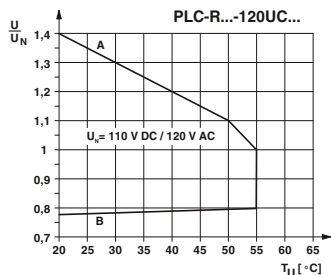
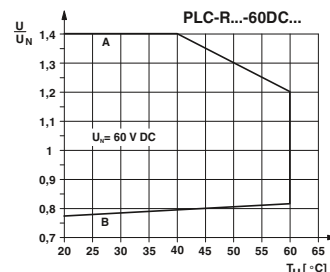
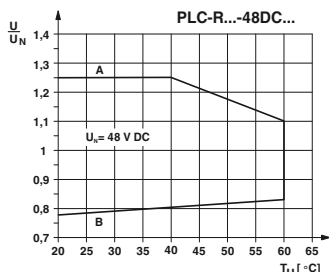
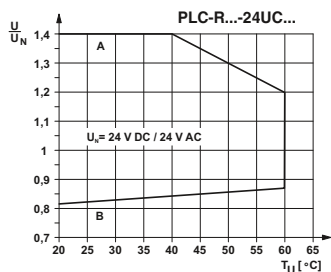
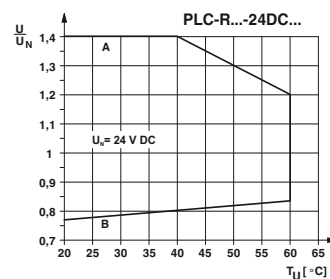
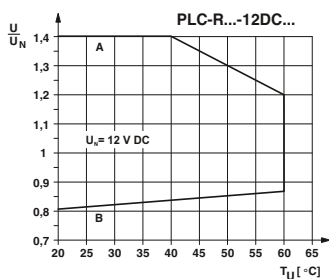

Operating voltage ranges for PLC-INTERFACE, 14 mm versions, equipped with relay

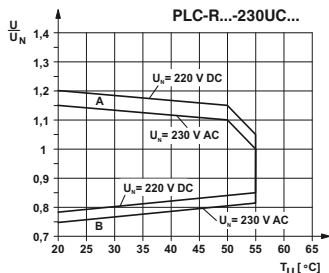
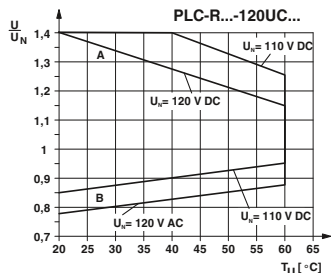
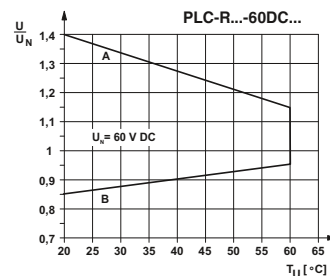
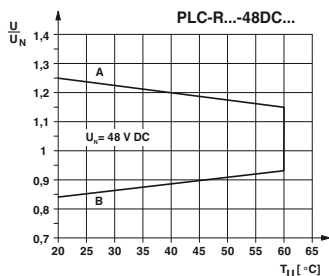
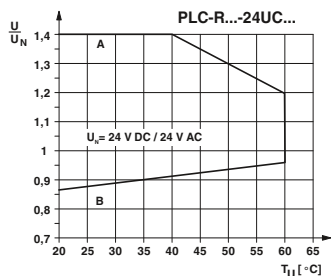
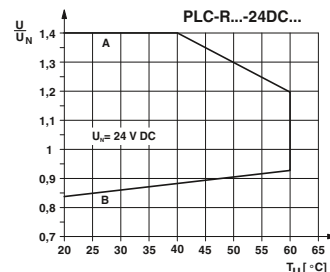
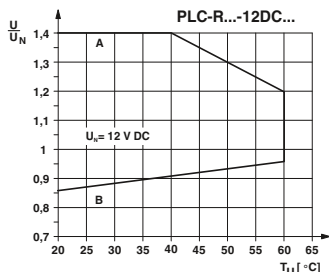

General conditions:

Direct alignment in the block, all devices 100% operating time, horizontal or vertical mounting.

Curve A

Maximum permissible continuous voltage U_{max} , with limiting continuous current on the contact side (see relevant technical data).

Curve B

Minimum permissible operate voltage U_{op} after pre-excitation¹⁾ (see relevant technical data).

^{1) Pre-excitation:} relay has been operated in a thermally steady state at the ambient temperature T_A with nominal voltage U_N and limiting continuous current on the contact side (see relevant technical data) (warm coil). After being switched off for a short time, the relay must reliably pick up again at U_{op} . The U_{op} values for cold coils ($T_{coil} = T_A = 20^\circ\text{C}$) indicated by other manufacturers yield better values, but are not practical.

Relay modules

Tables, diagrams, dimensional drawings

Plug-in miniature power relays

REL-MR...21

5 mm design width

Perforations for assembly: view of the connections

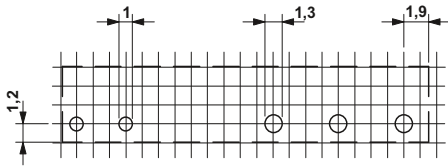

Pitch division: 1.25 mm and 1.27 mm

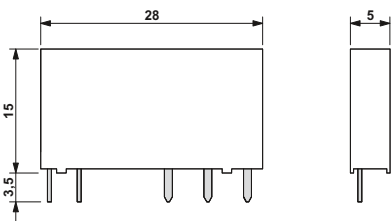

Permissible input voltage range for REL-MR...21

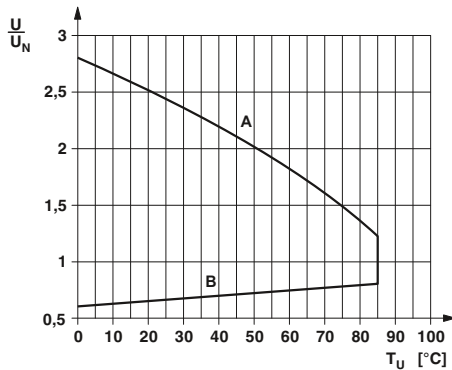

General conditions:

Direct alignment in the block, all devices 100% operating time, horizontal or vertical mounting.

Curve A

Maximum permissible continuous voltage U_{max} with limiting continuous current on the contact side (see relevant technical data).

Curve B

Minimum permissible operate voltage U_{op} after pre-excitation¹⁾ (see relevant technical data).

¹⁾ **Pre-excitation:** relay has been operated in a thermally steady state at the ambient temperature T_A with nominal voltage U_N and limiting continuous current on the contact side (see relevant technical data) (warm coil). After being switched off for a short time, the relay must reliably pick up again at U_{op} . The U_{op} values for cold coils ($T_{coil} = T_A = 20^\circ\text{C}$) indicated by other manufacturers yield better values, but are not practical.

REL-MR...21-21

12.7 mm design width

Perforations for assembly: view of the connections

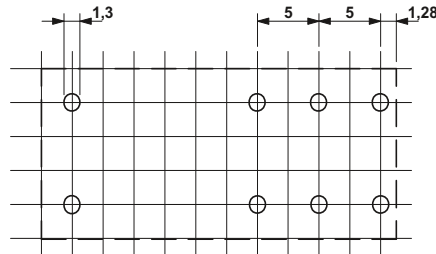

Pitch division: 2.5 mm

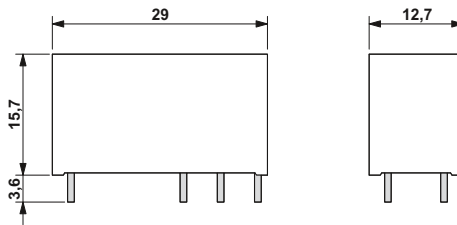

Permissible input voltage range for REL-MR...21-21, REL-MR-24DC/1IC, REL-MR...21HC

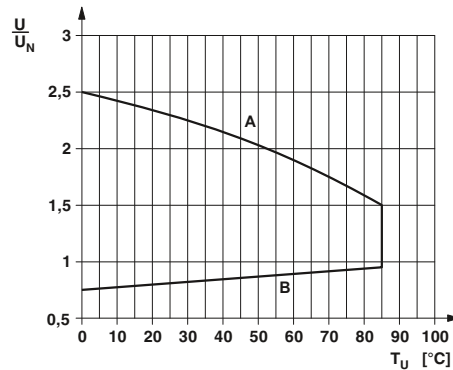

Plug-in solid-state relays

OPT...DC/24DC/2
OPT...DC/230AC/1

5 mm design width

Perforations for assembly: view of the connections

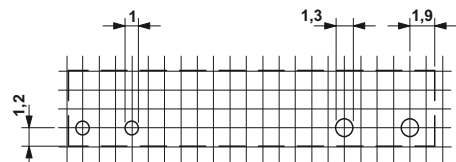

Pitch division: 1.25 mm and 1.27 mm

OPT...DC/24DC/5
OPT...DC/230AC/2

12.7 mm design width

Perforations for assembly: view of the connections

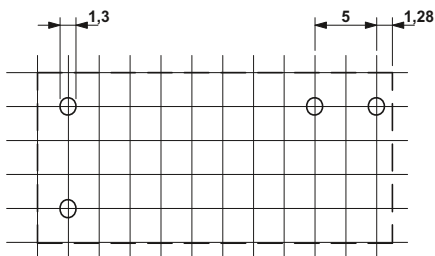

Pitch division: 2.5 mm

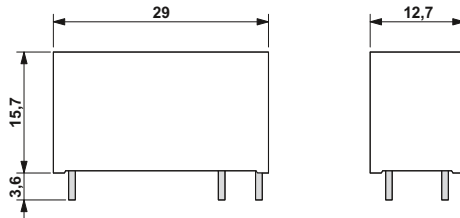
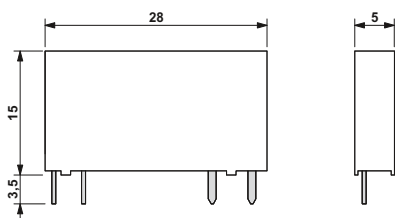

Derating curve for OPT...DC/24DC/2 and PLC-OS.../24DC/2 solid-state relays

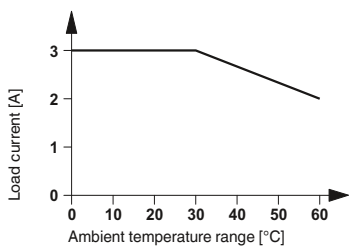

Derating curve for OPT...DC/24DC/5 and PLC-OS.../24DC/5/ACT solid-state relays

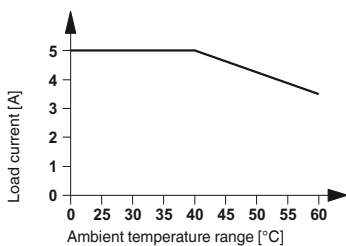

Derating curve for OPT...DC/230AC/1 and PLC-OS.../230AC/1 solid-state relays

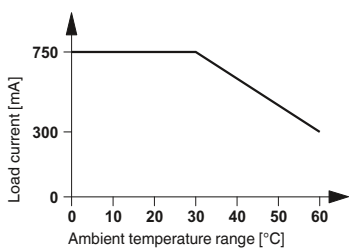

Derating curve for OPT...DC/230AC/2 and PLC-OS.../230AC/2/ACT solid-state relays

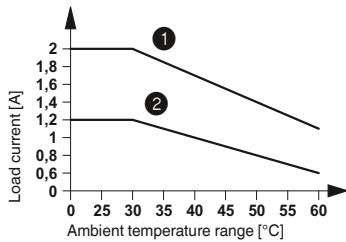

- ① Aligned with > 10 mm spacing
- ② Aligned without spacing

Relay modules

Tables, diagrams, dimensional drawings

Electrical interrupting rating for PLC-INTERFACE

Electrical interrupting rating for PLC...21 with 1 PDT relays

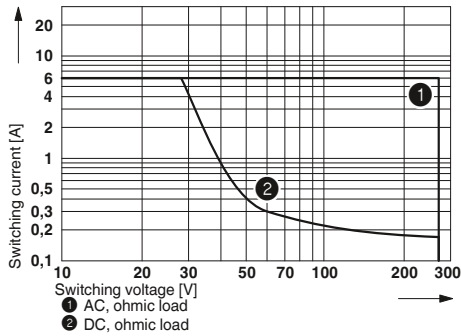

PLC-INTERFACE for railway applications

Electrical service life for PLC-RSP...UC/21RW

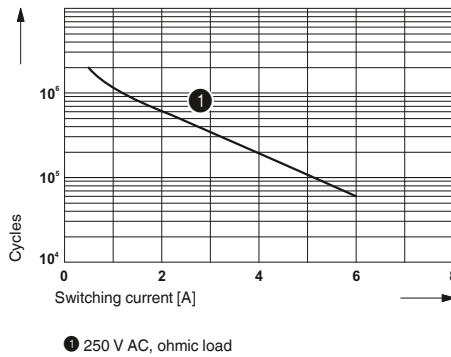

Electrical interrupting rating for PLC...21-21 with 2 PDT relays

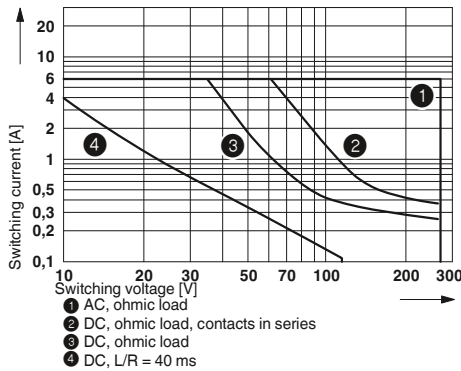

Electrical service life for PLC-RSP...UC/21-21/RW

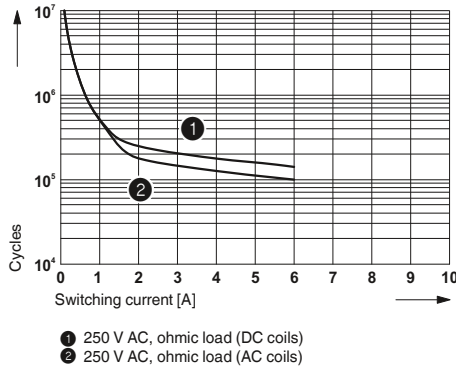

Electrical interrupting rating for PLC...11C/ACT for high inrush currents

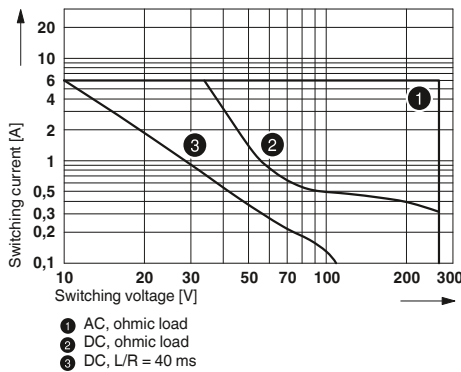

Electrical service life for PLC-RSP...UC/21HC/RW

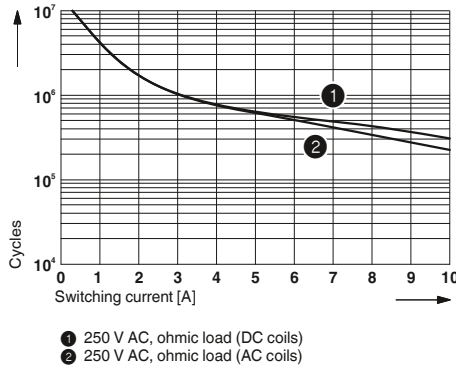

Electrical interrupting rating for PLC...21HC for high continuous currents

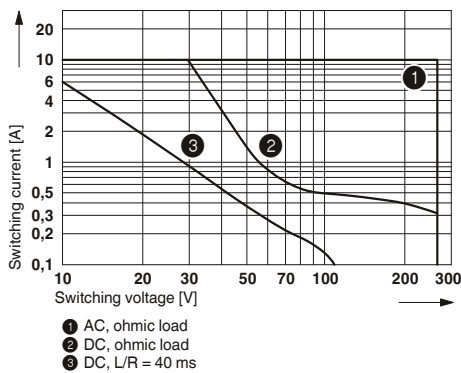

EMG-OV solid-state power relays

Derating curve for EMG 17-OV...48DC/2

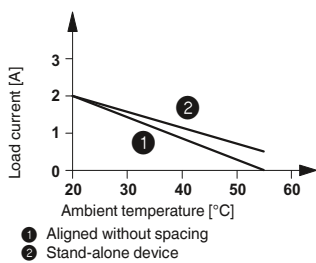

ST-OV 4-24DC/24DC...PRO power circuit breaker solid-state relays with signal logic

Derating curve for ST-OV 4-24DC/24DC...PRO

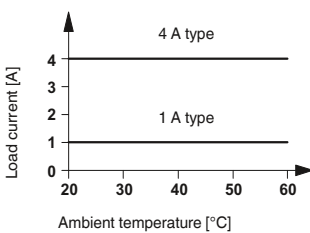

Time-current characteristic, 1 A version

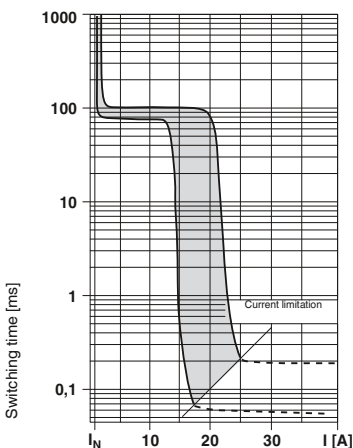

Time-current characteristic, 4 A version

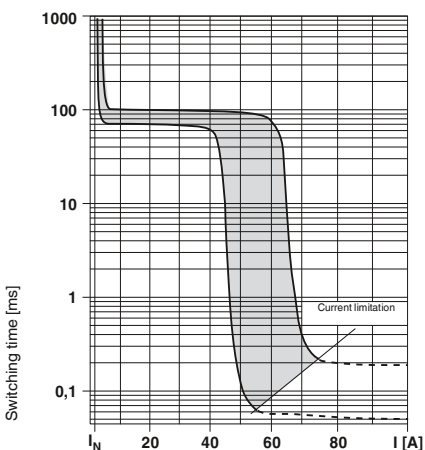

State diagram

Operating state	Switching level Input	Light indicator, yellow LED	Light indicator, red LED	Alarm contact/CONTROL
Not activated	L	L	L	
Normal operation	H	H	L	
Over-load/short circuit	H	H	H	
Opencircuit	L	L	H	

UEGM-OE/AV logic pulse expansion module

Time diagrams for UEGM-OE/AV-24DC/24DC/100

Scenario 1: input pulse $t_i < t_{O\ set}$

Operating voltage present

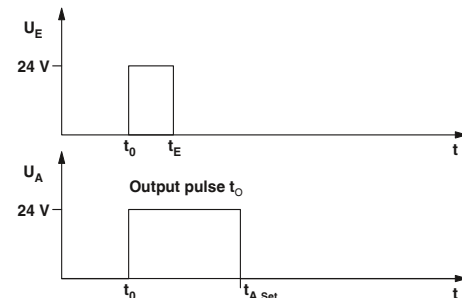

Scenario 2: input pulse $t_i \geq t_{O\ set}$; $t_i = t_o$

Operating voltage present

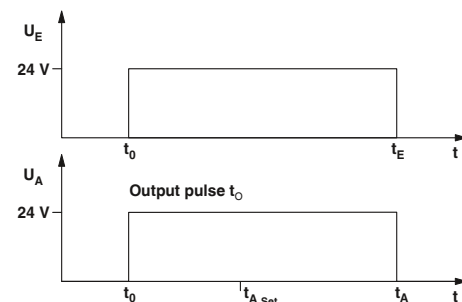

Table of adjustable output pulse lengths

	DIP switches ¹⁾							
	S1	S2	S3	S4	S5	S6	S7	S8
Length of output pulses [ms] (when in "on" switch position)	10	-	-	-	-	-	-	-
	-	20	-	-	-	-	-	-
	-	-	50	-	-	-	-	-
	-	-	-	100	-	-	-	-
	-	-	-	-	200	-	-	-
	-	-	-	-	-	500	-	-
	-	-	-	-	-	-	1000	-
	-	-	-	-	-	-	-	1500

¹⁾ If no switch is actuated, the output voltage is not defined.

If the input pulse is longer than the set time, the output is switched off almost simultaneously with the input.

Intermediate values can be obtained by combining several DIP switches according to the following formula:

$$T_{tot} = \frac{1}{\frac{1}{t_1} + \frac{1}{t_2} + \dots + \frac{1}{t_n}}$$

Relay modules

PLC series

PLC-INTERFACE with two integrated relays

Relay module with two permanently soldered-in power relays

The advantages:

- 100% more channel density than the conventional 6.2 mm relay
- Two switching channels in a 6.2 mm housing
- Integrated input circuit/protective circuit
- Safe isolation according to DIN EN 50178 between coil and contacts and between contacts
- Screw, spring-cage, and push-in technology

Notes:
Type of housing: Polyamide PA non-reinforced, color: green.
Marking systems and mounting material See Catalog 5
1) EMC: Class A product, see page 571



Two integrated relays

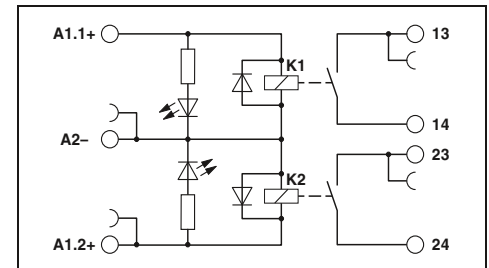

Technical data

Input data	①
Typ. input current at U_N	7 [mA]
Response/release time at U_N	4 / 6 [ms]
Input circuit DC	Yellow LED, Protection against polarity reversal, freewheeling diode
Output data	
Contact material	AgNi
Max. switching voltage	250 V AC/DC
Min. switching voltage	24 V AC/DC
Limiting continuous current	3.5 A
Min. switching current	5 mA
General data	
Test voltage input/output	3 kV AC (50 Hz, 1 min.)
Test voltage output/output	3 kV AC (50 Hz, 1 min.)
Ambient temperature (operation)	-20°C ... 60°C
Mechanical service life	2×10^7 cycles
Standards/regulations	IEC 60664, EN 50178, IEC 62103
Connection data solid / stranded / AWG	0.14 - 2.5 mm ² / 0.14 - 2.5 mm ² / 26 - 14
Dimensions	6.2 mm / 80 mm / 86 mm W / H / D

Ordering data

Description	Input voltage U_N	Type	Order No.	Pcs. / Pkt.
PLC INTERFACE, with screw connection ①	24 V DC	PLC-2RSC-24DC/ 1')	2987309	10
PLC INTERFACE, with spring-cage connection ①	24 V DC	PLC-2RSP-24DC/ 1')	2987312	10
PLC-INTERFACE, with push-in connection ①	24 V DC	PLC-2RPT-24DC/1')	2901639	10

Application example for PLC-2RS...24DC/1

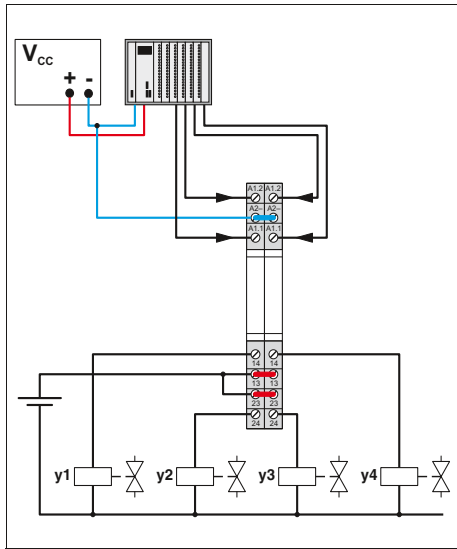

Operating voltage range

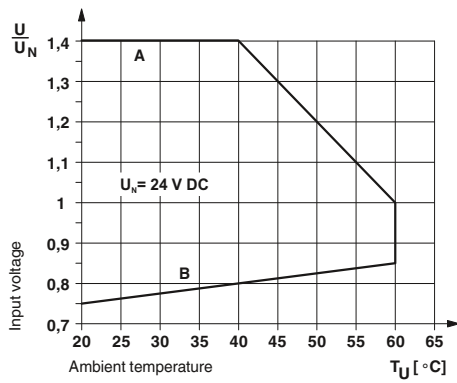

Interrupting rating

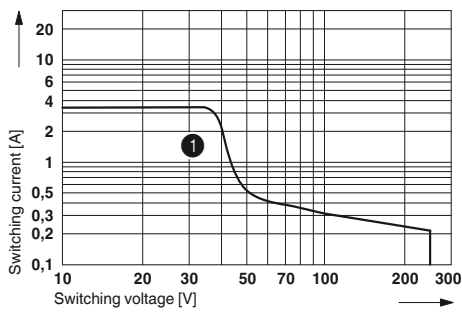

① DC, ohmic load

Relay modules

PLC series

PLC-INTERFACE with manual switch and relay

Relay module with manual switch and integrated power relay for manual, zero, and automatic functions

The advantages are:

- Max. switching current of 6 A
- Only 6.2 mm wide
- Floating confirmation contact
- Safe isolation according to DIN EN 50178 between coil and contact
- Screw, spring-cage, and push-in technology

Notes:
Type of housing: Polyester PBT non-reinforced, color: green.
Marking systems and mounting material See Catalog 5
For the protection of input and output, inductive loads must be dampened with an effective protection circuit.
Separating plate PLC-ATP is to be used in the following cases: always at the start and end of a PLC terminal strip, for voltages greater than 250 V (L1, L2, L3) between the same terminal points of neighboring modules (potential bridging then takes place with FBST 8-PLC... or FBST 500...) and with safe isolation between neighboring modules.
Module height: PLC-...-S/H = 90 mm; PLC-...-S/L: = 86 mm
PLC...H - manual operation PLC...L - operation using screwdriver
1) EMC: Class A product, see page 571



Relay module with manual switch and integrated relay

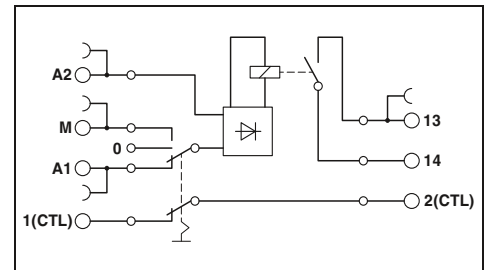

Application example PLC-RS...24UC/1/S...

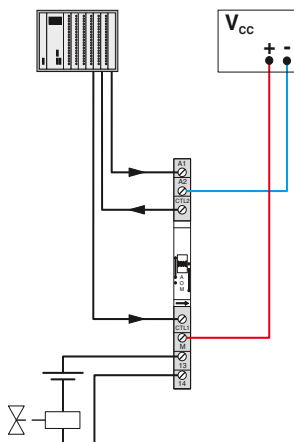

Permissible input voltage range for PLC-RS...24UC/1/S...

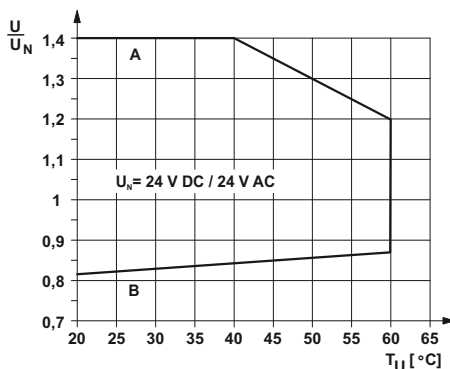

Curve A maximum continuous voltage at limiting continuous current = 6 A

Curve B minimum operating voltage for pre-excitation with U_N and limiting continuous current = 6 A

Input data	
Typ. input current at U_N	[mA]
Response/release time at U_N	[ms]
Input circuit AC/DC	
Output data	
Contact material	AgSnO
Max. switching voltage	250 V AC/DC
Min. switching voltage	5 V (at 100 mA)
Limiting continuous current	6 A
Max. inrush current	(on request)
Min. switching current	10 mA (at 12 V)
Feedback	
Operating mode "Automatic" floating	max. 30 V AC/DC / 50 mA min. 2 V AC/DC / 1 mA
General data	
Rated insulation voltage	250 V AC
Rated surge voltage	6 kV
Ambient temperature (operation)	-20°C ... 60°C
Standards/regulations	IEC 60664, EN 50178, IEC 62103
Pollution degree/surge voltage category	2 / III
Connection data solid / stranded / AWG	0.14 - 2.5 mm ² / 0.14 - 2.5 mm ² / 26 - 14
Dimensions	W / H / D 6.2 mm / 80 mm / 90 mm

Technical data

	①	②
Typ. input current at U_N	11	11
Response/release time at U_N	6 / 15	6 / 15
Input circuit AC/DC	Yellow LED, Bridge rectifier	
Contact material	AgSnO	
Max. switching voltage	250 V AC/DC	
Min. switching voltage	5 V (at 100 mA)	
Limiting continuous current	6 A	
Max. inrush current	(on request)	
Min. switching current	10 mA (at 12 V)	
Operating mode "Automatic" floating	max. 30 V AC/DC / 50 mA min. 2 V AC/DC / 1 mA	
Rated insulation voltage	250 V AC	
Rated surge voltage	6 kV	
Ambient temperature (operation)	-20°C ... 60°C	
Standards/regulations	IEC 60664, EN 50178, IEC 62103	
Pollution degree/surge voltage category	2 / III	
Connection data solid / stranded / AWG	0.14 - 2.5 mm ² / 0.14 - 2.5 mm ² / 26 - 14	
Dimensions	W / H / D 6.2 mm / 80 mm / 90 mm	

Description	Input voltage U_N
PLC INTERFACE, with screw connection	
①	24 V AC/DC
②	24 V AC/DC
PLC INTERFACE, with spring-cage connection	
①	24 V AC/DC
②	24 V AC/DC
PLC-INTERFACE, with push-in connection	
①	24 V AC/DC
②	24 V AC/DC

Ordering data

Type	Order No.	Pcs. / Pkt.
PLC-RSC- 24UC/ 1/S/H	2982236	10
PLC-RSC- 24UC/ 1/S/L ¹⁾	2834876	10
PLC-RSP- 24UC/ 1/S/H	2982249	10
PLC-RSP- 24UC/ 1/S/L ¹⁾	2834889	10
PLC-RPT- 24UC/ 1/S/H ¹⁾	2900328	10
PLC-RPT- 24UC/ 1/S/L ¹⁾	2900327	10

PLC-INTERFACE with manual switch without relay

Switching module without relay for manual, zero, and automatic functions

The advantages:

- Only 6.2 mm wide
- Floating confirmation contact
- Screw and spring-cage connection technology

Notes:
Type of housing: Polyester PBT non-reinforced, color: green.
Marking systems and mounting material See Catalog 5
For the protection of input and output, inductive loads must be dampened with an effective protection circuit.
Separating plate PLC-ATP is to be used in the following cases: always at the start and end of a PLC terminal strip, for voltages greater than 250 V (L1, L2, L3) between the same terminal points of neighboring modules (potential bridging then takes place with FBST 8-PLC... or FBST 500...) and with safe isolation between neighboring modules.
Module height: PLC-...-S/H = 90 mm; PLC-...-S/L: = 86 mm
PLC...-H - manual operation PLC...-L - operation using screwdriver



Module with manual switch without relay

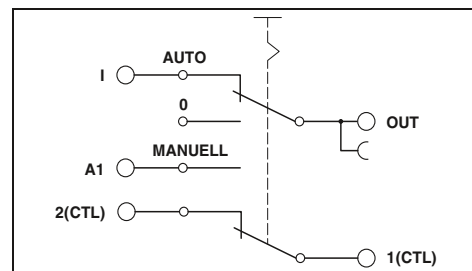

Technical data

Max. switching voltage	72 V DC
Min. switching voltage	2 V DC
Max. inrush current	50 mA
Min. switching current	1 mA
Cycles, max.	100 (At 72 V DC / 50 mA) / 10000 (at 12 V DC / 100 mA)
Feedback	
Operating mode "Automatic" floating	≤ 72 V DC / 50 mA
General data	
Rated insulation voltage	85 V AC
Rated surge voltage	0.5 kV / basic insulation
Ambient temperature (operation)	-20°C ... 60°C
Standards/regulations	IEC 60664, EN 50178, IEC 62103
Pollution degree/surge voltage category	2 / III
Dimensions	W / H / D 6.2 mm / 80 mm / 90 mm

Ordering data

Description	Type	Order No.	Pcs. / Pkt.
PLC INTERFACE, with screw connection			
	PLC-SC-S/H	2980733	10
	PLC-SC-S/L	2980775	10
PLC INTERFACE, with spring-cage connection			
	PLC-SP-S/H	2980746	10
	PLC-SP-S/L	2980788	10

Application example PLC-S...S...

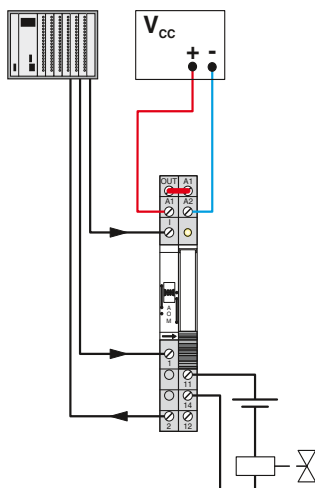

Relay modules

PLC series

PLC-INTERFACE with an integrated solid-state relay

The slim 6.2 mm PLC housing with integrated electronics in various versions offers the following advantages:

- Option of bridging adjacent modules
- Status display
- Protection circuits in input and output
- Wear-resistant and bounce-free switching
- Integrated protection circuit
- DC outputs of up to 300 V DC/1 A or up to 24 V DC/10 A
- Electronic PDT output of up to 48 V DC/500 mA
- Screw, spring-cage, and push-in technology

Notes:
Type of housing: Polyester PBT non-reinforced, color: green.
Marking systems and mounting material See Catalog 5
For the protection of input and output, inductive loads must be dampened with an effective protection circuit.
Separating plate PLC-ATP is to be used in the following cases: always at the start and end of a PLC terminal strip, for voltages greater than 250 V (L1, L2, L3) between the same terminal points of neighboring modules (potential bridging then takes place with FBST 8-PLC... or FBST 500...) and with safe isolation between neighboring modules.
The housings of the following modules are open on one side: - PLC-OS...-300DC/1 - PLC-OS...-24DC/24DC/10/R
1) EMC: Class A product, see page 571



Power solid-state relay with DC voltage output, max. 1 A

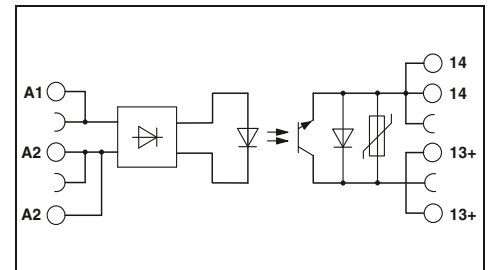

Input data	
Permissible range (with reference to U_N)	
Switching level (with reference to U_N)	1 signal ("H") 0 signal ("L")
Typ. input current at U_N	[mA]
Transmission frequency f_{limit}	[Hz]
Alarm output	
Operating range	- / -
Output data	
Max. / min. switching voltage	300 V DC / 12 V DC
Limiting continuous current	1 A (see derating curve)
Voltage drop at max. limiting continuous current	< 500 mV
General data	
Rated insulation voltage	300 V
Rated surge voltage	4 kV / basic insulation
Ambient temperature (operation)	-25°C ... 60°C
Standards/regulations	IEC 60664, EN 50178, IEC 62103
Connection data solid / stranded / AWG	0.14 - 2.5 mm ² / 0.14 - 2.5 mm ² / 26 - 14
Dimensions	W / H / D 6.2 mm / 80 mm / 86 mm

Technical data							
①	②	③	④	⑤	⑥	⑦	⑧
0.8 - 1.2	0.8 - 1.2	0.8 - 1.2	0.8 - 1.2	0.8 - 1.2	0.8 - 1.2	0.8 - 1.1	0.8 - 1.1
≥ 0.8	≥ 0.8	≥ 0.8	≥ 0.8	≥ 0.8	≥ 0.8	≥ 0.8	≥ 0.8
≤ 0.4	≤ 0.4	≤ 0.4	≤ 0.4	≤ 0.4	≤ 0.4	≤ 0.4	≤ 0.4
15	6	8	5	5	3	5.6	8.4
50	50	50	50	50	50	10	10

Ordering data	
Type	Order No.
PLC-OSC- 5DC/300DC/ 1')	2980652
PLC-OSC- 12DC/300DC/ 1')	2980665
PLC-OSC- 24DC/300DC/ 1')	2980678
PLC-OSC- 60DC/300DC/ 1')	2980681
PLC-OSC-110DC/300DC/ 1')	2980694
PLC-OSC-220DC/300DC/ 1')	2980704
PLC-OSC-120AC/300DC/ 1')	2980717
PLC-OSC-230AC/300DC/ 1')	2980720

Description	Input voltage U_N
PLC INTERFACE, with screw connection	
①	5 V DC
②	12 V DC
③	24 V DC
④	60 V DC
⑤	110 V DC
⑥	220 V DC
⑦	120 V AC
⑧	230 V AC
PLC INTERFACE, with spring-cage connection	
①	5 V DC
②	12 V DC
③	24 V DC
④	60 V DC
⑤	110 V DC
⑥	220 V DC
⑦	120 V AC
⑧	230 V AC
PLC-INTERFACE, with push-in connection	
①	5 V DC
②	12 V DC
③	24 V DC
④	60 V DC
⑤	110 V DC
⑥	220 V DC
⑦	120 V AC
⑧	230 V AC

Type	Order No.	Pcs. / Pkt.
PLC-OSC- 5DC/300DC/ 1')	2980652	10
PLC-OSC- 12DC/300DC/ 1')	2980665	10
PLC-OSC- 24DC/300DC/ 1')	2980678	10
PLC-OSC- 60DC/300DC/ 1')	2980681	10
PLC-OSC-110DC/300DC/ 1')	2980694	10
PLC-OSC-220DC/300DC/ 1')	2980704	10
PLC-OSC-120AC/300DC/ 1')	2980717	10
PLC-OSC-230AC/300DC/ 1')	2980720	10
PLC-OSP- 5DC/300DC/ 1')	2980814	10
PLC-OSP- 12DC/300DC/ 1')	2980827	10
PLC-OSP- 24DC/300DC/ 1')	2980830	10
PLC-OSP- 60DC/300DC/ 1')	2980843	10
PLC-OSP-110DC/300DC/ 1')	2980856	10
PLC-OSP-220DC/300DC/ 1')	2980869	10
PLC-OSP-120AC/300DC/ 1')	2980872	10
PLC-OSP-230AC/300DC/ 1')	2980885	10
PLC-OPT- 5DC/300DC/1')	2900381	10
PLC-OPT- 12DC/300DC/1')	2900382	10
PLC-OPT- 24DC/300DC/1')	2900383	10
PLC-OPT- 60DC/300DC/1')	2900384	10
PLC-OPT-110DC/300DC/1')	2900385	10
PLC-OPT-220DC/300DC/1')	2900387	10
PLC-OPT-120AC/300DC/1')	2900388	10
PLC-OPT-230AC/300DC/1')	2900389	10



Power solid-state relay with short-circuit-proof DC voltage output, max. 10 A, with feedback



Input solid-state relay with DC voltage output, max. 500 mA, with electronic PDT

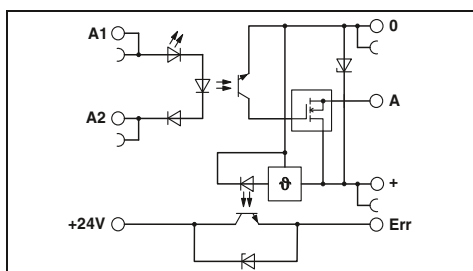

Technical data

- ③
- 0.8 - 1.2
- ≥ 0.8
- ≤ 0.4
- 3
- 100

3 V DC ... 33 V DC (High active) / 100 mA

33 V DC / 5 V DC
10 A (see derating curve)
≤ 50 mV

300 V
4 kV / basic insulation
-25°C ... 60°C
IEC 60664, EN 50178, IEC 62103
0.14 - 2.5 mm² / 0.14 - 2.5 mm² / 26 - 14
6.2 mm / 80 mm / 86 mm

Ordering data

Type	Order No.	Pcs. / Pkt.
PLC-OSC- 24DC/ 24DC/ 10/R ¹)	2982702	10
PLC-OSP- 24DC/ 24DC/ 10/R ¹)	2982715	10
PLC-OPT- 24DC/ 24DC/10/R ¹)	2900398	10

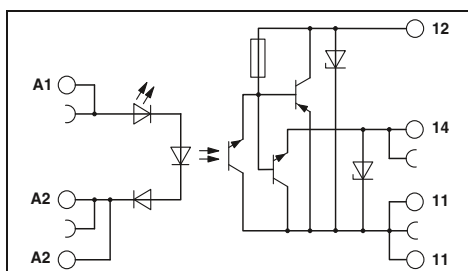

Technical data

- ③
- 0.8 - 1.2
- ≥ 0.8
- ≤ 0.4
- 3
- 1000

- / -

48 V DC / 3 V DC
500 mA (see derating curve)
< 1.2 V

300 V
4 kV / basic insulation
-25°C ... 60°C
IEC 60664, EN 50178, IEC 62103
0.14 - 2.5 mm² / 0.14 - 2.5 mm² / 26 - 14
6.2 mm / 80 mm / 86 mm

Ordering data

Type	Order No.	Pcs. / Pkt.
PLC-OSC- 24DC/ 48DC/500/W ¹)	2980636	10
PLC-OSP- 24DC/ 48DC/500/W ¹)	2980649	10
PLC-OPT- 24DC/ 48DC/500/W ¹)	2900378	10

Derating curve for PLC...300DC/1

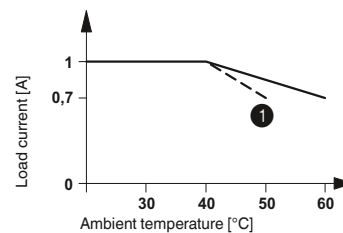

① For input voltages 220 V DC and 230 V AC

Derating curve for PLC-...24DC/24DC/10/R

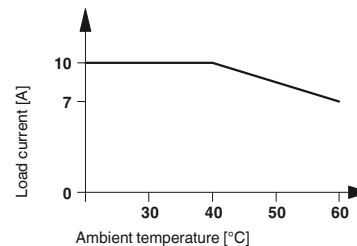

Derating curve for PLC-...24DC/48DC/500/W

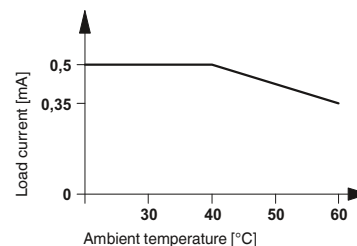

PLC-INTERFACE

Solid-state relays up to 100 kHz

A solid-state relay for the safe acquisition of short pulses.

- Status display
- Bridging options
- Limit frequency of up to 100 kHz
- Push-pull stage on output side
- Features a capacitor on the input side for interference suppression

Notes:
Type of housing: Polyamide PA non-reinforced, color: green.
Marking systems and mounting material See Catalog 5
1) EMC: Class A product, see page 571



N

with DC voltage output
Transmission frequency 100 kHz

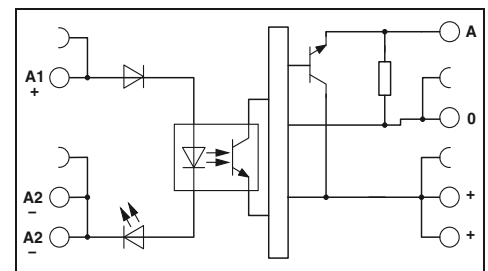

Input data	
Permissible range (with reference to U_N)	
Switching level with reference to U_N	1 signal ("H") 0 signal ("L")
Typ. input current at U_N	[mA]
Typ. switch-on time at U_N	[μ s]
Typ. switch-off time at U_N	[μ s]
Transmission frequency f_{limit}	[kHz]
Input protection:	
Output data	
Operating voltage range	
Limiting continuous current	
Quiescent current	
Residual voltage drop at "H"	
Output circuit	
Output protection	
General data	
Test voltage input/output	
Ambient temperature (operation)	
Standards/regulations	
Pollution degree/surge voltage category	
Connection data solid / stranded / AWG	
Dimensions	W / H / D

Technical data	
①	②
0.8 - 1.2	0.8 - 1.2
> 0.8	> 0.8
< 0.4	< 0.4
7	6
1.5	1.5
2	2
100	100
LED yellow, Protection against polarity reversal, Surge protection	
4 V DC ... 30 V DC	
50 mA	
4.3 mA	
< 0.5 V	
3-conductor, ground-referenced	
Protection against polarity reversal, Surge protection	
2.5 kV _{ms} (50 Hz, 1 min.)	
-20°C ... 60°C	
DIN EN 50178	
2 / II	
0.14 - 2.5 mm ² / 0.14 - 2.5 mm ² / 26 - 14	
6.2 mm / 80 mm / 86 mm	

Description	Input voltage U_N
Input solid-state relay with push-in connection	
①	5 V DC
②	24 V DC
Input solid-state relay with screw connection	
①	5 V DC
②	24 V DC

Ordering data		
Type	Order No.	Pcs. / Pkt.
PLC-OSC- 5DC/24DC/100KHZ ¹⁾	2902963	1
PLC-OSC- 24DC/24DC/100KHZ ¹⁾	2902964	1
PLC-OPT- 5DC/ 24DC/100KHZ ¹⁾	2902969	1
PLC-OPT- 24DC/24DC/100KHZ ¹⁾	2902970	1



N

with DC voltage output push-pull
Transmission frequency 100 kHz



N

with DC voltage output push-pull
Transmission frequency 100 kHz

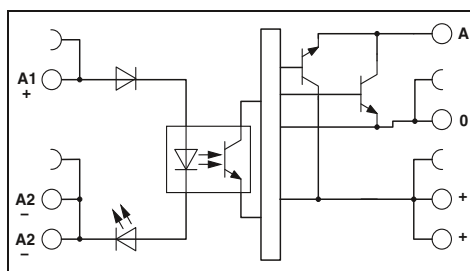
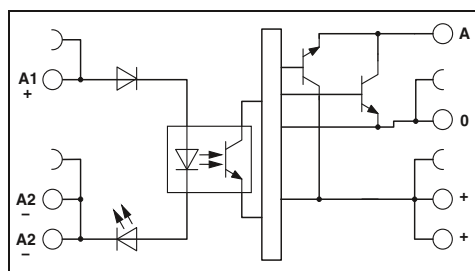

Technical data

①	②
0.5 - 1.2	0.8 - 1.2
> 0.5	> 0.8
< 0.3	< 0.4
8	8
1	1
2	2
100	100
LED yellow, Protection against polarity reversal, Surge protection	

Technical data

①	②
0.5 - 1.2	0.8 - 1.2
> 0.5	> 0.8
< 0.3	< 0.4
8	8
1	1
2	2
100	100
LED yellow, Protection against polarity reversal, Surge protection	

4 V DC ... 18 V DC
50 mA
8.5 mA
< 1.2 V
3-conductor push-pull, ground referenced
Protection against polarity reversal, Surge protection

14 V DC ... 30 V DC
50 mA
15 mA
< 2.2 V
3-conductor push-pull, ground referenced
Protection against polarity reversal, Surge protection

2.5 kV_{rms} (50 Hz, 1 min.)
-20°C ... 60°C
DIN EN 50178
2 / II
0.14 - 2.5 mm² / 0.14 - 2.5 mm² / 26 - 14
6.2 mm / 80 mm / 86 mm

2.5 kV_{rms} (50 Hz, 1 min.)
-20°C ... 60°C
DIN EN 50178
2 / II
0.14 - 2.5 mm² / 0.14 - 2.5 mm² / 26 - 14
6.2 mm / 80 mm / 86 mm

Ordering data

Type	Order No.	Pcs. / Pkt.
PLC-OSC- 5DC/ 5DC/100KHZ-G ¹)	2902965	1
PLC-OSC- 24DC/ 5DC/100KHZ-G ¹)	2902966	1
PLC-OPT- 5DC/ 5DC/100KHZ-G ¹)	2902971	1
PLC-OPT- 24DC/ 5DC/100KHZ-G ¹)	2902972	1

Ordering data

Type	Order No.	Pcs. / Pkt.
PLC-OSC- 5DC/ 24DC/100KHZ-G ¹)	2902967	1
PLC-OSC- 24DC/ 24DC/100KHZ-G ¹)	2902968	1
PLC-OPT- 5DC/24DC/100KHZ-G ¹)	2902973	1
PLC-OPT- 24DC/24DC/100KHZ-G ¹)	2902974	1

PLC-INTERFACE for the TTL signal at the input

The PLC-BS...TTL/1 basic terminal block is controlled using a TTL (5 V) input signal and can be equipped with a mechanical relay or a solid-state relay as an option. The basic terminal block equipped with a robust miniature relay offers the following advantages:

- 6.2 mm slim design width
- Bridging options
- Status display
- Screw and spring-cage connection
- RTIII degree of protection
- Safe isolation in accordance with EN 50178 (VDE 0160)
- 4 kV_{rms} electrical isolation between coil and contact.
- Screw, spring-cage, and push-in technology

Notes:
Type of housing: Polyester PBT non-reinforced, color: green.
Marking systems and mounting material See Catalog 5
1) EMC: Class A product, see page 571



Basic terminal block, for fitting with relay for TTL (5 V)

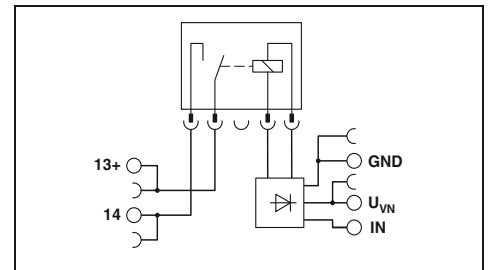

Technical data

Input data	
Rated control supply voltage U_{VN}	5 V DC
Rated control supply voltage range with reference to U_{VN}	0.9 ... 1.2
Rated control supply current I_{VN}	41 mA
Rated actuating voltage U_c (IN)	5 V DC (TTL)
Rated actuating voltage range with reference to U_c	0.9 ... 1.2
Rated actuating current I_c	2.5 mA
Typ. response time at U_c	4.5 ms
Typ. release time for U_c	3.5 ms
Input circuit	Yellow LED, Protection against polarity reversal, Surge protection
Output data with:	
Contact type	REL-MR-4,5DC/21 AU REL-MR-4,5DC/21 Single contact, 1 N/O contact Single contact, 1 N/O contact
Contact material	AgSnO, hard gold-plated AgSnO
Max. switching voltage	30 V AC / 36 V DC 250 V AC/DC
Min. switching voltage	100 mV (at 10 mA) 5 V (at 100 mA)
Limiting continuous current	50 mA 6 A
Max. inrush current	50 mA (on request)
Min. switching current	1 mA (at 24 V) 10 mA (at 12 V)
General data	
Rated insulation voltage	250 V
Rated surge voltage / insulation	6 kV
Ambient temperature (operation)	-20°C ... 60°C
Mechanical service life	2 x 10 ⁷ cycles
Air and creepage distances between the power circuits	IEC 60664, EN 50178, IEC 62103
Pollution degree / Surge voltage category	2 / III
Mounting position / Assembly	Any / In rows with zero spacing
Connection data solid / stranded / AWG	0.14 - 2.5 mm ² / 0.14 - 2.5 mm ² / 26 - 14
Dimensions	W / H / D 6.2 mm / 80 mm / 94 mm

5 V DC
0.9 ... 1.2
41 mA
5 V DC (TTL)
0.9 ... 1.2
2.5 mA
4.5 ms
3.5 ms
Yellow LED, Protection against polarity reversal, Surge protection
REL-MR-4,5DC/21 AU REL-MR-4,5DC/21
Single contact, 1 N/O contact Single contact, 1 N/O contact
AgSnO, hard gold-plated AgSnO
30 V AC / 36 V DC 250 V AC/DC
100 mV (at 10 mA) 5 V (at 100 mA)
50 mA 6 A
50 mA (on request)
1 mA (at 24 V) 10 mA (at 12 V)
250 V
6 kV
-20°C ... 60°C
2 x 10 ⁷ cycles
IEC 60664, EN 50178, IEC 62103
2 / III
Any / In rows with zero spacing
0.14 - 2.5 mm ² / 0.14 - 2.5 mm ² / 26 - 14
W / H / D 6.2 mm / 80 mm / 94 mm

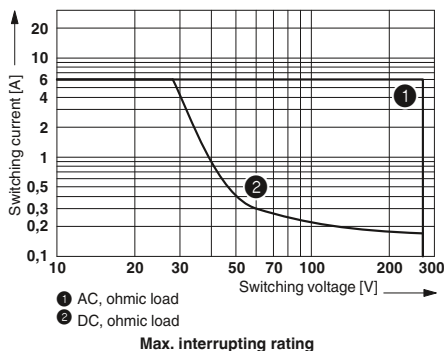

Description
PLC-INTERFACE
With screw connection
With spring-cage connection
With push-in connection
Plug-in miniature power relays
with gold contact
with power contact

Ordering data

Type	Order No.	Pcs. / Pkt.
PLC-BSC-TTL(1')	2982689	10
PLC-BSP-TTL(1')	2982692	10
PLC-BPT-TTL(1')	2900458	10

Accessories

REL-MR 4,5DC/21AU	2961370	10
REL-MR- 4,5DC/21	2961367	10

PLC-INTERFACE for the TTL signal at the input

The PLC-BS...TTL/1 basic terminal block is controlled using a TTL (5 V) input signal and can be equipped with a mechanical relay or a solid-state relay as an option. The basic terminal block equipped with a solid-state relay offers the following advantages:

- 6.2 mm slim design width
- Bridging options
- Status display
- Screw and spring-cage connection
- IP67-protected solid-state relay electronic unit
- Switching capacity of up to 24 V DC/3 A
- Alternative input or power solid-state relay
- Wear-free and output-free
- Integrated protection circuit
- Insensitive to vibrations and shocks
- 2.5 kV_{rms} electrical isolation between input and output
- Screw, spring-cage, and push-in technology

Notes:
Type of housing: Polyester PBT non-reinforced, color: green.
Marking systems and mounting material See Catalog 5
For derating curves see page 345
1) EMC: Class A product, see page 571



Basic terminal block for fitting with solid-state relay for TTL (5 V)

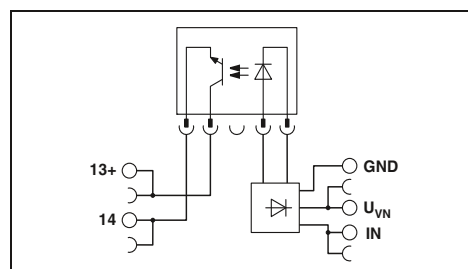

Technical data

Input data		
Rated control supply voltage U_{VN}	5 V DC	
Rated control supply voltage range with reference to U_{VN}	0.9 ... 1.2	
Rated control supply current I_{VN}	11.5 mA	
Rated actuating voltage U_c (IN)	5 V DC (TTL)	
Switching level 1 signal ("H") (TTL signal)	> 2 V DC	
Switching level 0 signal ("L") (TTL signal)	< 0.8 V DC	
Rated actuating current I_c	2.5 mA	
Typ. response time/switch-on time at U_c	35 μ s	
Typ. switch-off time at U_c	320 μ s	
Input circuit	Yellow LED, Protection against polarity reversal, Surge protection	
Output data with:	OPT-5DC/48DC/100	OPT-5DC/24DC/2
Max. switching voltage	48 V DC	33 V DC
Min. switching voltage	3 V DC	3 V DC
Limiting continuous current	100 mA	3 A
Output protection	Protection against polarity reversal, Surge protection	Protection against polarity reversal, Surge protection
Voltage drop at limiting continuous current	< 1 V	< 200 mV
General data		
Rated insulation voltage	250 V	
Rated surge voltage / insulation	6 kV/basic isolation	
Ambient temperature (operation)	-20°C ... 60°C	
Air and creepage distances between the power circuits	IEC 60664, EN 50178, IEC 62103	
Pollution degree / Surge voltage category	2 / III	
Connection data solid / stranded / AWG	0.14 - 2.5 mm ² / 0.14 - 2.5 mm ² / 26 - 14	
Dimensions	6.2 mm / 80 mm / 94 mm	W / H / D

Ordering data

Description	Type	Order No.	Pcs. / Pkt.
PLC-INTERFACE			
With screw connection	PLC-BSC-TTL/1 ¹⁾	2982689	10
With spring-cage connection	PLC-BSP-TTL/1 ¹⁾	2982692	10
With push-in connection	PLC-BPT-TTL/1 ¹⁾	2900458	10

Accessories

Plug-in solid-state relays			
Solid-state input relays	OPT-5DC/48DC/100	2967992	10
Solid-state power relays	OPT-5DC/24DC/2	2967989	10

PLC-INTERFACE for the TTL signal at the output

The PLC-OS...24DC/TTL with a built-in solid-state relay can be used for fast and wear-free switching of TTL (5 V) signals.

The module offers the following advantages:

- Switching capacity TTL (5 V), fan out = 1
- 6.2 mm slim design width
- Bridging options
- Status display
- Screw and spring-cage connection
- Integrated protection circuit
- Insensitive to vibrations and shocks
- Screw, spring-cage, and push-in technology

Notes:
Type of housing: Polyester PBT non-reinforced, color: green.
Marking systems and mounting material See Catalog 5
1) EMC: Class A product, see page 571



Input solid state relay with TTL (5 V) output

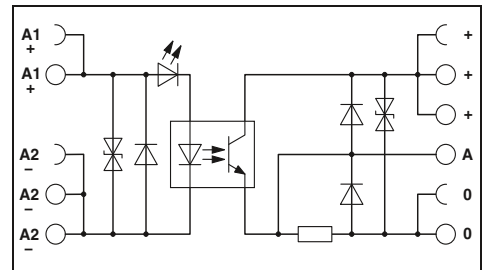

Technical data

Input data			
Rated actuating voltage U_C	24 V DC		
Rated actuating voltage range with reference to U_C	0.8 ... 1.2		
Switching level 1 signal ("H")	> 0.8		
Switching level 0 signal ("L")	< 0.4		
Rated actuating current I_C	3.4 mA		
Typ. switch-on time for U_C	35 μ s		
Typ. switch-off time at U_C	35 μ s		
Transmission frequency f_{limit}	1 kHz		
Input circuit DC	Yellow LED, Protection against polarity reversal, Surge protection		
Output data with:			
Rated control supply voltage U_S	5 V DC		
Rated control supply voltage range with reference to U_S	0.9 ... 1.2		
Limiting continuous current	(A TTL load (Fan out = 1)/50 mA for switching mode)		
Output protection	Protection against polarity reversal, Surge protection		
Voltage drop at max. limiting continuous current	< 80 mV		
General data			
Rated insulation voltage	250 V DC		
Rated surge voltage / insulation	4 kV / basic insulation		
Ambient temperature (operation)	-25°C ... 60°C		
Air and creepage distances between the power circuits	IEC 60664, EN 50178, IEC 62103		
Pollution degree/surge voltage category	2 / III		
Connection data solid / stranded / AWG	0.14 - 2.5 mm ² / 0.14 - 2.5 mm ² / 26 - 14		
Dimensions	W / H / D 6.2 mm / 80 mm / 86 mm		
Ordering data			
Description	Type	Order No.	Pcs. / Pkt.
PLC-INTERFACE With screw connection With spring-cage connection With push-in connection	PLC-OSC- 24DC/TTL ¹⁾	2982728	10
	PLC-OSP- 24DC/TTL ¹⁾	2982731	10
	PLC-OPT- 24DC/TTL ¹⁾	2900363	10

Derating curve for PLC-OSP...24DC/3RW

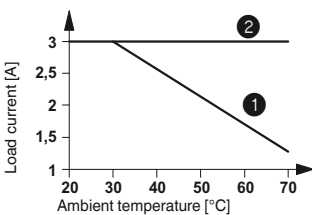

- ① Aligned without spacing
- ② Aligned with ≥ 20 mm spacing

Derating curve for PLC-OSP...110DC/3RW

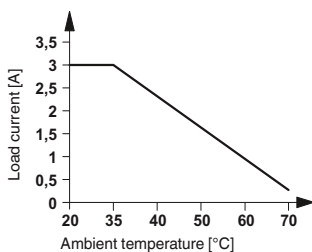

PLC-INTERFACE with solid-state relays for railway applications

The PLC-OSP...RW interface modules are intended for use as per DIN EN 50155 (VDE 0115 part 200) "Railway applications, Part 200: Electronic devices in rail vehicles".

The advantages:

- Temperature range -25°C to +70°C
- Input voltage range 0.7 - 1.25 x U_N
- Shock resistance according to DIN 50155 (requirements according to EN 61373).
- Screw, spring-cage, and push-in technology



Power solid-state relay with DC voltage output, max. 3 A



Power solid-state relay with DC voltage output, max. 3 A

Notes:	
Type of housing:	Polyester PBT non-reinforced, color: green.
Marking systems and mounting material	See Catalog 5
For derating curves see page 358	
1) EMC: Class A product, see page 571	

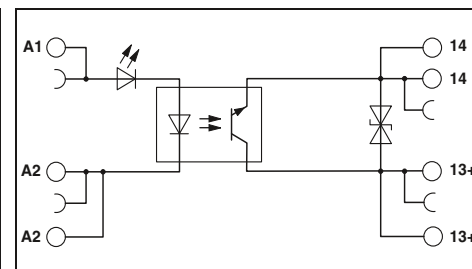
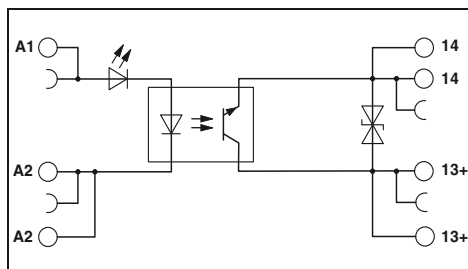

Input data	
Permissible range (with reference to U _N)	
Switching level (with reference to U _N)	1 signal ("H") 0 signal ("L")
Typ. input current at U _N	[mA]
Typ. switch-on time at U _N	[ms]
Typ. switch-off time at U _N	[ms]
Transmission frequency f _{limit}	[Hz]
Input circuit DC	

Technical data	
①	⑥
0.7 - 1.25	0.7 - 1.25
≥ 0.6	≥ 0.6
≤ 0.3	≤ 0.3
8.5	3
0.04	0.08
0.2	0.6
300	100
Yellow LED, Protection against polarity reversal	

Technical data					
①	②	③	④	⑤	⑥
0.7 - 1.25	0.7 - 1.25	0.7 - 1.25	0.7 - 1.25	0.7 - 1.25	0.7 - 1.25
> 0.6	> 0.6	> 0.6	> 0.6	> 0.6	> 0.6
< 0.4	< 0.4	< 0.3	< 0.3	< 0.3	< 0.3
12	12	5.5	5.5	5.5	5.5
0.4	0.4	0.04	0.04	0.04	0.4
0.2	0.1	0.2	0.2	0.2	0.2
50	50	300	300	300	300
Yellow LED, Protection against polarity reversal, Surge protection					

Output data	
Max. switching voltage	33 V DC
Min. switching voltage	3 V DC
Limiting continuous current	3 A (see derating curve)
Output protection	Protection against polarity reversal, Surge protection
Voltage drop at max. limiting continuous current	< 200 mV
General data	
Rated insulation voltage	250 V
Rated surge voltage	4 kV / basic insulation
Ambient temperature (operation)	-25°C ... 70°C
Standards/regulations	IEC 60664, EN 50178, IEC 62103
Pollution degree/surge voltage category	2 / III
Connection data solid / stranded / AWG	0.14 - 2.5 mm ² / 0.14 - 2.5 mm ² / 26 - 14
Dimensions	W / H / D 6.2 mm / 80 mm / 86 mm

Technical data	
140 V DC	12 V DC
3 A (see derating curve)	3 A (see derating curve)
Protection against polarity reversal, Surge protection	Protection against polarity reversal, Surge protection
< 150 mV	
General data	
160 V DC	4 kV / basic insulation
-25°C ... 70°C	IEC 60664, EN 50178, IEC 62103
2 / III	0.14 - 2.5 mm ² / 0.14 - 2.5 mm ² / 26 - 14
	6.2 mm / 80 mm / 86 mm

Description	Input voltage U _N
PLC INTERFACE, with spring-cage connection	
①	24 V DC
②	36 V DC
③	48 V DC
④	72 V DC
⑤	96 V DC
⑥	110 V DC
PLC-INTERFACE, with push-in connection	
①	24 V DC
②	36 V DC
③	48 V DC
④	72 V DC
⑤	96 V DC
⑥	110 V DC

Ordering data			
Type	Order No.	Pcs. / Pkt.	
PLC-OSP- 24DC/ 24DC/ 3RW	2980513	10	
PLC-OSP-110DC/ 24DC/ 3RW	2980526	10	
PLC-OPT- 24DC/ 24DC/3RW ¹⁾	2900379	10	
PLC-OPT-110DC/ 24DC/3RW ¹⁾	2900380	10	

Ordering data			
Type	Order No.	Pcs. / Pkt.	
PLC-OSP- 24DC/110DC/ 3RW ¹⁾	2982511	10	
PLC-OSP- 36DC/110DC/ 3RW ¹⁾	2982524	10	
PLC-OSP- 48DC/110DC/ 3RW ¹⁾	2982537	10	
PLC-OSP- 72DC/110DC/ 3RW ¹⁾	2982540	10	
PLC-OSP- 96DC/110DC/ 3RW ¹⁾	2982553	10	
PLC-OSP-110DC/110DC/ 3RW ¹⁾	2982566	10	
PLC-OPT- 24DC/110DC/3RW ¹⁾	2900391	10	
PLC-OPT- 36DC/110DC/3RW ¹⁾	2900392	10	
PLC-OPT- 48DC/110DC/3RW ¹⁾	2900393	10	
PLC-OPT- 72DC/110DC/3RW ¹⁾	2900394	10	
PLC-OPT- 96DC/110DC/3RW ¹⁾	2900395	10	
PLC-OPT-110DC/110DC/3RW ¹⁾	2900396	10	

Relay modules

PLC series

PLC-INTERFACE for railway applications

Relay modules with extended input voltage and temperature range, specifically for use in railway applications

The advantages:

- Temperature range -25°C to +70°C
- Input voltage range 0.7 to 1.25 x UN
- Vibration and shock resistance to EN 50155
- Safe isolation according to DIN EN 50178 between coil and contact
- Spring cage and push-in connection method

Notes:
Type of housing: Polyamide PA non-reinforced, color: green.
Marking systems and mounting material See Catalog 5
Separating plate PLC-ATP must be installed for voltages larger than 250 V (L1, L2, L3) between identical terminal blocks in adjacent modules. Potential bridging is then carried out with FBST 8-PLC... or FBST 500....
If the specified maximum values for multi-layer contact relays are exceeded, the gold plating is destroyed. The maximum values of the power contact relay are then valid. This can result in a shorter service life than with a pure power contact.
1) EMC: Class A product, see page 571



Basic terminal block that can be fitted with 1 PDT relay

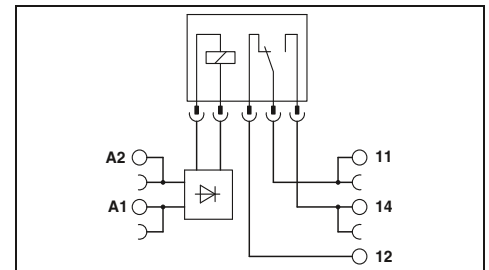

Permissible input voltage range for PLC-BSP-24DC/21RW (with REL-MR-18DC/21... relay)

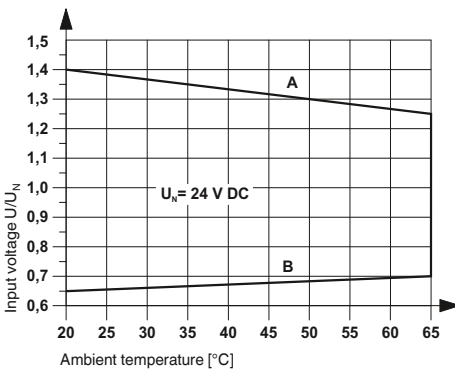

Curve A
Maximum continuous voltage at limiting continuous current = 3 A

Curve B
Minimum operate voltage for pre-excitation with U_N and limiting continuous current = 3 A

Electrical interrupting rating for PLC...21 with 1 PDT relay

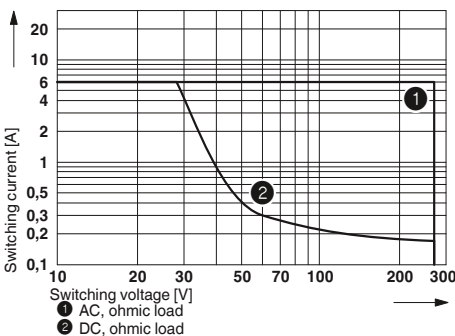

Input data
Nominal input voltage U _N
Permissible range (with reference to U _N)
Typ. input current at U _N
Typ. response time at U _N
Typ. release time at U _N
Input circuit
Output data with:
Contact type
Contact material
Max. switching voltage
Min. switching voltage
Limiting continuous current
Max. inrush current
Min. switching current
General data
Test voltage input/output
Ambient temperature (operation)
Mechanical service life
Standards/regulations
Pollution degree / Surge voltage category
Connection data solid / stranded / AWG
Dimensions

Technical data	
24 V DC	
See diagram	
12 mA	
5 ms	
8 ms	
Yellow LED, Protection against polarity reversal, freewheeling diode	
REL-MR-18DC/21	REL-MR-18DC/21AU
Single contact, 1-PDT	Single contact, 1-PDT
AgSnO	AgSnO, hard gold-plated
250 V AC/DC	30 V AC / 36 V DC
5 V (at 100 mA)	100 mV (at 10 mA)
3 A	50 mA
(on request)	50 mA
10 mA (at 12 V)	1 mA (at 24 V)
4 kV (50 Hz, 1 min.)	
-25°C ... 70°C	
2 x 10 ⁷ cycles	
IEC 60664, EN 50178, IEC 62103	
3 / III	
0.14 - 2.5 mm ² / 0.14 - 2.5 mm ² / 26 - 14	
6.2 mm / 80 mm / 94 mm	

Description	Voltage U _N
PLC-INTERFACE basic terminal block, for plug-in miniature relay	
With spring-cage connection	24 V DC
With push-in connection	24 V DC

Ordering data		
Type	Order No.	Pcs. / Pkt.
PLC-BSP- 24DC/21RW ¹⁾	2961396	10
PLC-BPT- 24DC/21RW ¹⁾	2900261	10

Plug-in miniature relays	
with power contact	
with gold contact	

Accessories		
Type	Order No.	Pcs. / Pkt.
REL-MR- 18DC/21	2961383	10
REL-MR- 18DC/21AU	2961493	10

PLC-INTERFACE for railway applications

Relay module for input voltages with a nominal frequency of 16.7 Hz

The advantages:

- Input nominal frequency 16.7 Hz
- Vibration and shock resistance to EN 50155
- Safe isolation according to DIN EN 50178 between coil and contact
- Spring cage and push-in connection method

Notes:
Type of housing: Polyamide PA non-reinforced, color: green.
Marking systems and mounting material See Catalog 5
Separating plate PLC-ATP must be installed for voltages larger than 250 V (L1, L2, L3) between identical terminal blocks in adjacent modules. Potential bridging is then carried out with FBST 8-PLC... or FBST 500....
If the specified maximum values for multi-layer contact relays are exceeded, the gold plating is destroyed. The values in parentheses then apply for further operation. This can result in a shorter service life than with a pure power contact.
1) EMC: Class A product, see page 571



For 16.7 Hz input frequency with 2 PDTs

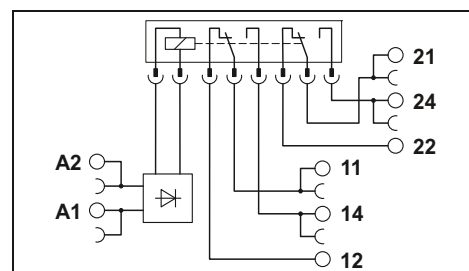

Technical data

Input data	
Nominal input voltage U_N	230 V AC
Input nominal frequency	16.67 Hz
Permissible range (with reference to U_N)	(refer to the diagram)
Typ. input current at U_N	4.8 mA (with AC)
Typ. response time at U_N	20 ms
Typ. release time at U_N	60 ms
Input circuit	Yellow LED, Bridge rectifier
Output data	
Contact type	Single contact, 2-PDT
Contact material	AgNi, hard gold-plated
Max. switching voltage	30 V AC / 36 V DC (250 V AC/DC)
Min. switching voltage	100 mV (5 V AC/DC)
Limiting continuous current	50 mA (6 A)
Max. inrush current	50 mA (8 A)
Min. switching current	1 mA (10 mA)
General data	
Test voltage input/output	6 kV
Ambient temperature (operation)	-25°C ... 60°C
Mechanical service life	Approx. 3×10^7 cycles
Standards/regulations	IEC 60664, EN 50178, IEC 62103
Pollution degree / Surge voltage category	2 / III
Connection data solid / stranded / AWG	0.14 - 2.5 mm ² / 0.14 - 2.5 mm ² / 26 - 14
Dimensions	W / H / D 14 mm / 80 mm / 94 mm

Ordering data

Description	Voltage U_N	Type	Order No.	Pcs. / Pkt.
PLC-INTERFACE				
With spring-cage connection	230 V AC	PLC-RSP-230UC/21-21AU/RWF ¹⁾	2968001	10
With push-in connection	230 V AC	PLC-RPT-230UC/21-21AU/RWF ¹⁾	2900345	10

Permissible input voltage range for PLC-RSP-230UC/21-21AU/RWF

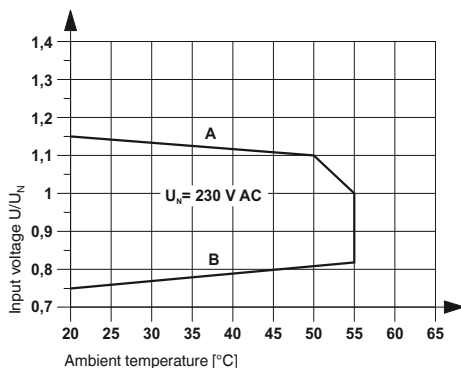

Curve A
maximum continuous voltage at limiting continuous current = 6 A

Curve B
minimum operating voltage for pre-excitation with U_N and limiting continuous current = 6 A

PLC-INTERFACE for railway applications

Relay modules with extended input voltage and temperature range, specifically designed for railway applications

The advantages:

- Certified to EN 50155
- Optimum relay operation thanks to wide-range electronics
- Temperature range from -40°C to +70°C (short-term 85°C)
- Input voltage range 0.7 to 1.25 x U_N (short-term 1.4 x U_N)
- Vibration and shock resistance to EN 50155
- Safe isolation according to DIN EN 50178 between coil and contact
- Spring cage and push-in connection method

Notes:
Type of housing: Polyamide PA non-reinforced, color: green.
Marking systems and mounting material See Catalog 5
Separating plate PLC-ATP must be installed for voltages larger than 250 V (L1, L2, L3) between identical terminal blocks in adjacent modules. Potential bridging is then carried out with FBST 8-PLC... or FBST 500....
If the specified maximum values for multi-layer contact relays are exceeded, the gold plating is destroyed. The maximum values of the power contact relay are then valid. This can result in a shorter service life than with a pure power contact.
Electrical service life diagrams, see page 346
1) EMC: Class A product, see page 571



1 PDT

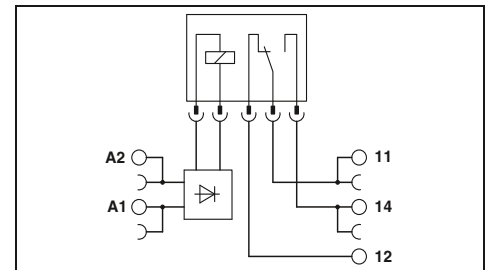

Technical data

Input data	
Permissible range (with reference to U _N)	
Typ. input current at U _N	[mA]
Typ. response time at U _N	[ms]
Typ. release time at U _N	[ms]
Input protection:	
Output data	
Contact type	
Contact material	
Max. switching voltage	
Min. switching voltage	
Limiting continuous current	
Max. inrush current	
Min. switching current	
General data	
Test voltage (winding / contact)	
Ambient temperature (operation)	
Mechanical service life	
Standards/regulations	
Connection data solid / stranded / AWG	
Dimensions	W / H / D

①	②	③
0.7 - 1.25	0.7 - 1.25	0.7 - 1.25
9	3	2
4	4	4
4	4	4
Yellow LED, Bridge rectifier, freewheeling diode		
Single contact, 1-PDT		Single contact, 1-PDT
AgSnO		AgSnO, hard gold-plated
250 V AC/DC		30 V AC / 36 V DC
5 V (at 100 mA)		100 mV
6 A		50 mA
(on request)		50 mA
10 mA (at 12 V)		1 mA
4 kV _{rms} (50 Hz, 1 min.)		
-40°C ... 70°C (Temperature class TX)		
Approx. 2 x 10 ⁷ cycles		
EN 50155 (VDE 0115 part 200), EN 50178, IEC 62103, EN 61373, EN 50121		
0.14 - 2.5 mm ² / 0.14 - 2.5 mm ² / 26 - 14		
6.2 mm / 80 mm / 94 mm		

Ordering data

Description	Input voltage U _N
PLC-INTERFACE, with power contact	
	With spring-cage connection
	① 24 V DC
	② 72 V DC
	③ 110 V DC
	With push-in connection
① 24 V DC	
② 72 V DC	
③ 110 V DC	
PLC-INTERFACE, with hard gold-plated contact	
	With spring-cage connection
	① 24 V DC
	② 72 V DC
	③ 110 V DC
	With push-in connection
① 24 V DC	
② 72 V DC	
③ 110 V DC	

Type	Order No.	Pcs. / Pkt.		
PLC-INTERFACE, with power contact				
	With spring-cage connection			
	① 24 V DC	PLC-RSP- 24UC/21/RW ¹⁾	2987011	10
	② 72 V DC	PLC-RSP- 72UC/21/RW ¹⁾	2987037	10
	③ 110 V DC	PLC-RSP-110UC/21/RW ¹⁾	2987053	10
	With push-in connection			
① 24 V DC	PLC-RPT- 24UC/21/RW ¹⁾	2900318	10	
② 72 V DC	PLC-RPT- 72UC/21/RW ¹⁾	2900319	10	
③ 110 V DC	PLC-RPT-110UC/21/RW ¹⁾	2900320	10	
PLC-INTERFACE, with hard gold-plated contact				
	With spring-cage connection			
	① 24 V DC	PLC-RSP- 24UC/21AU/RW ¹⁾	2987024	10
	② 72 V DC	PLC-RSP- 72UC/21AU/RW ¹⁾	2987040	10
	③ 110 V DC	PLC-RSP-110UC/21AU/RW ¹⁾	2987066	10
	With push-in connection			
① 24 V DC	PLC-RPT- 24UC/21AU/RW ¹⁾	2900321	10	
② 72 V DC	PLC-RPT- 72UC/21AU/RW ¹⁾	2900322	10	
③ 110 V DC	PLC-RPT-110UC/21AU/RW ¹⁾	2900323	10	



2 PDT



1 PDT up to 10 A

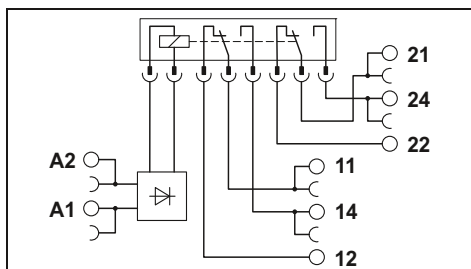

Technical data

①	②	③
0.7 - 1.25	0.7 - 1.25	0.7 - 1.25
20	6	4.5
5	5	5
11	11	11

Yellow LED, Bridge rectifier, freewheeling diode

Single contact, 2-PDT	Single contact, 2-PDT
AgNi	AgNi, hard gold-plated
250 V AC/DC	30 V AC / 36 V DC
5 V (at 100 mA)	100 mV
2x 6 A	50 mA
15 A (300 ms)	50 mA
10 mA (at 12 V)	1 mA

5 kV_{rms} (50 Hz, 1 min.)
 -40°C ... 70°C (Temperature class TX)
 Approx. 3 x 10⁷ cycles
 EN 50155 (VDE 0115 part 200), EN 50178, IEC 62103, EN 61373, EN 50121
 0.14 - 2.5 mm² / 0.14 - 2.5 mm² / 26 - 14
 14 mm / 80 mm / 94 mm

Ordering data

Type	Order No.	Pcs. / Pkt.
PLC-RSP- 24UC/21-21/RW ¹⁾	2987105	10
PLC-RSP- 72UC/21-21/RW ¹⁾	2987121	10
PLC-RSP-110UC/21-21/RW ¹⁾	2987147	10
PLC-RPT- 24UC/21-21/RW ¹⁾	2900346	10
PLC-RPT- 72UC/21-21/RW ¹⁾	2900347	10
PLC-RPT-110UC/21-21/RW ¹⁾	2900348	10
PLC-RSP- 24UC/21-21AU/RW ¹⁾	2987118	10
PLC-RSP- 72UC/21-21AU/RW ¹⁾	2987134	10
PLC-RSP-110UC/21-21AU/RW ¹⁾	2987150	10
PLC-RPT- 24UC/21-21AU/RW ¹⁾	2900349	10
PLC-RPT- 72UC/21-21AU/RW ¹⁾	2900350	10
PLC-RPT-110UC/21-21AU/RW ¹⁾	2900351	10

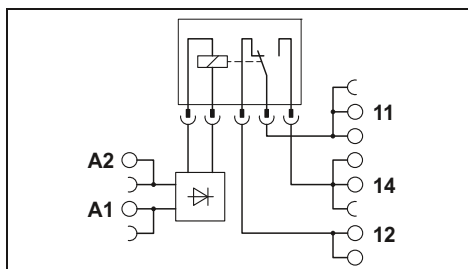

Technical data

①	②	③
0.7 - 1.25	0.7 - 1.25	0.7 - 1.25
20	6	4.5
5	5	5
11	11	11

Yellow LED, Bridge rectifier, freewheeling diode

Single contact, 1-PDT
AgNi
250 V AC/DC
12 V AC/DC
10 A (With inserted bridge 2967691)
30 A (300 ms)
10 mA

5 kV_{rms} (50 Hz, 1 min.)
 -40°C ... 70°C (Temperature class TX)
 Approx. 3 x 10⁷ cycles
 EN 50155 (VDE 0115 part 200), EN 50178, IEC 62103, EN 61373, EN 50121
 0.14 - 2.5 mm² / 0.14 - 2.5 mm² / 26 - 14
 14 mm / 80 mm / 94 mm

Ordering data

Type	Order No.	Pcs. / Pkt.
PLC-RSP- 24UC/21HC/RW ¹⁾	2987079	10
PLC-RSP- 72UC/21HC/RW ¹⁾	2987082	10
PLC-RSP-110UC/21HC/RW ¹⁾	2987095	10
PLC-RPT- 24UC/21HC/RW ¹⁾	2900324	10
PLC-RPT- 72UC/21HC/RW ¹⁾	2900325	10
PLC-RPT-110UC/21HC/RW ¹⁾	2900326	10

Derating curve for

PLC-RSP...21/RW
 PLC-RSP...21AU/RW
 PLC-RSP...21-21/RW
 PLC-RSP...21-21AU/RW

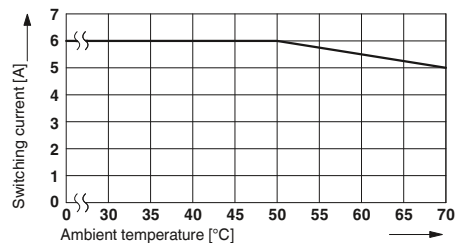

Interrupting rating for PLC-RSP...UC/21RW

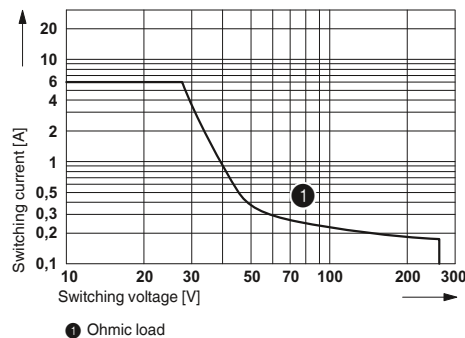

Interrupting rating for PLC-RSP...UC/21-21/RW

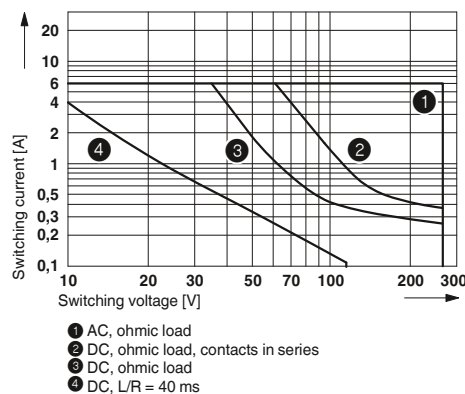

Interrupting rating for PLC-RSP...UC/21HC/RW

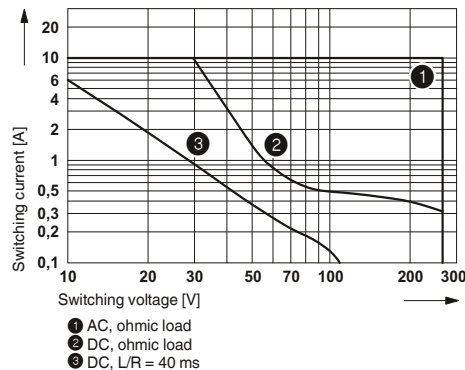

PLC electronic sensor terminal block for NAMUR proximity sensors

The PLC-...EIK 1-SVN electronic sensor terminal block from Phoenix Contact converts the changeable resistance of a NAMUR sensor unit into a digital signal that can be read by all PLCs.

In addition, the electronics unit monitors the sensor side for short-circuits or wire breaks and reports this error via an integrated LED.

Due to a corresponding resistance circuit, the PLC-...-EIK 1-SVN can be used to monitor all mechanical switches (N/C contact or N/O contact) for short-circuits and/or wire break.

In addition to a high packing density, this switching amplifier features the following:

- Regulated power supply for the NAMUR proximity switch
- 24 V/50 mA digital output for directly connecting programmable logic controls
- Connection option for PLC-V8 adapter
- Screw, spring-cage, and push-in technology

Application 1

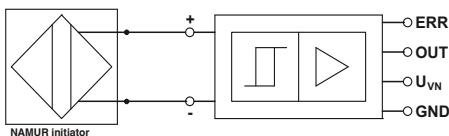

Application 2

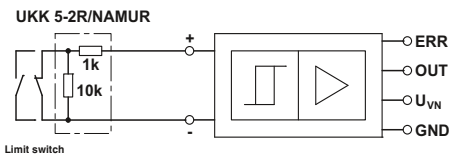

Initiator state	Switching level		LED	
	OUT	ERR	Green	Red
conductive	L	L	OFF	OFF
blocking	H	L	ON	OFF
short circuit	L	H	OFF	ON
open circuit	L	H	OFF	ON

Notes:

Type of housing:
Polyamide PA non-reinforced, color: green.

Marking systems and mounting material
See Catalog 5

Separating plate PLC-ATP is to be used in the following cases: always at the start and end of a PLC terminal strip, for voltages greater than 250 V (L1, L2, L3) between the same terminal points of neighboring modules (potential bridging then takes place with FBST 8-PLC... or FBST 500...) and with safe isolation between neighboring modules.

1) EMC: Class A product, see page 571



For inductive proximity sensors according to NAMUR, with light indicators for sensor signal and faults

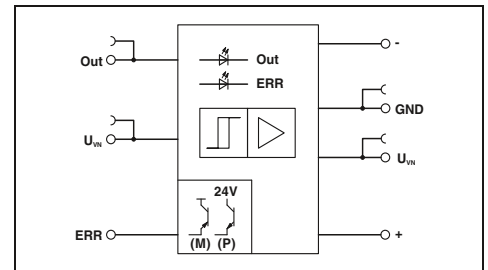

Technical data

Supply

Input supply nominal voltage U_{VN}
Typ. input current at U_{VN}
Transmission frequency f_{limit}
Input circuit

24 V DC $\pm 20\%$

Approx. 14 mA

Approx. 350 Hz

Green LED, Protection against polarity reversal, Surge protection

Control circuit

No-load voltage
Switching points in accordance with EN 60947-5-6:

8.2 V DC $\pm 10\%$

≥ 2.1 mA (In conductive state)

≤ 1.2 mA (In blocking state)

6.3 mA ... 10 mA (in the event of a short-circuit)

0 mA ... 0.35 mA (In the event of a wire break)

Surge protection

Protective circuit

Alarm output

Operating voltage range (positive switching)
Limiting continuous current
Voltage drop at max. limiting continuous current
Output protection

$(U_{VN} - U_{Res})$

50 mA

≤ 1.5 V (U_R)

Red LED, Surge protection

Signal output

Limiting continuous current
Voltage drop U_R at max. limiting continuous current
Output protection

50 mA

≤ 1.5 V (U_R)

Surge protection

General data

Rated insulation voltage
Rated surge voltage / insulation
Ambient temperature (operation)
Standards/regulations
Pollution degree / Surge voltage category
Connection data solid / stranded / AWG
Dimensions

50 V DC

0.4 kV / Basic isolation

-25°C ... 50°C

IEC 60664, EN 50178, IEC 62103

2 / 1

0.14 - 2.5 mm² / 0.14 - 2.5 mm² / 26 - 12

6.2 mm / 80 mm / 86 mm

W / H / D

Ordering data

Description

Switching amplifier electronic terminal block, positive switching

With screw connection
With spring-cage connection
With push-in connection

Type

Order No.

Pcs. / Pkt.

PLC-SC-EIK 1-SVN 24P/P¹)

2982663

10

PLC-SP-EIK 1-SVN 24P/P¹)

2982676

10

PLC-PT-EIK 1-SVN 24P/P¹)

2900397

10

Accessories

Double-level terminal block, with preassembled resistors

With screw connection

UKK 5-2R/NAMUR

2941662

50

PLC series

Electronic reversing load relay for DC motors

The PLC-S...-ELR W 1/2-24DC electronic reversing load relays are used to switch mechanically commutated DC motors up to 24 V/2 A.

- Wear-free reversing
- Braking by controlling both inputs
- Short-circuit and surge- and overload-proof output
- Integrated locking circuit and load wiring
- Screw, spring-cage, and push-in technology

Notes:
Type of housing: Polyester PBT non-reinforced, color: green.
Marking systems and mounting material See Catalog 5
Separating plate PLC-ATP is to be used in the following cases: always at the start and end of a PLC terminal strip, for voltages greater than 250 V (L1, L2, L3) between the same terminal points of neighboring modules (potential bridging then takes place with FBST 8-PLC... or FBST 500...) and with safe isolation between neighboring modules.
For the protection of input and output, inductive loads must be dampened with an effective protection circuit.
PWM = Pulse Width Modulation
1) EMC: Class A product, see page 571



With overload and short-circuit-proof output

Application example for PLC-S...ELR W 1/2-24DC

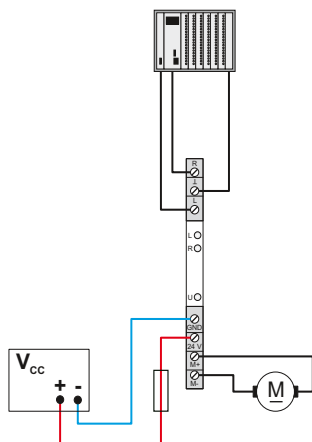

Status table

Input		Output	
Right	Left	M +	M -
0	0	High resistance	High resistance
1	0	+24 V	GND
0	1	GND	+24 V
1	1	GND	GND

Derating curve for PLC-S...ELR W 1/2-24DC

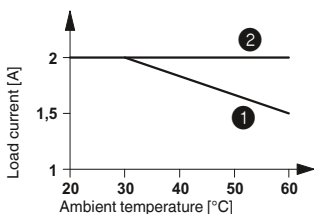

- 1 Aligned without spacing
- 2 Aligned with > 20 mm spacing

Input data	Control voltage U_{ST} right/left Control input current I_{ST} right/left Input protection:
PWM option	Max. clock frequency of the PWM at the control inputs
	Pulse width repetition rate of the PWM
Output data	Supply voltage range U_V Quiescent current Output protection
Motor switching output	Continuous current I_A max. Current limitation at short-circuits
General data	Rated insulation voltage Rated surge voltage / insulation Ambient temperature (operation) Standards/regulations Pollution degree / Surge voltage category Mounting position Mounting Connection data solid / stranded / AWG Dimensions

(R)

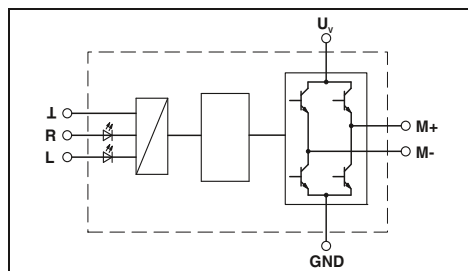

Technical data

24 V DC $\pm 20\%$ Approx. 3 mA Yellow LED, Protection against polarity reversal, Surge protection
1000 Hz
0% ... 100%
10 V DC ... 30 V DC 10 mA Green LED, Protection against polarity reversal, Surge protection
2 A (see derating curve) 15 A (during braking)
50 V DC 0.5 kV / basic insulation -25°C ... 60°C IEC 60664, EN 50178, IEC 62103 2 / II Vertical (horizontal DIN rail) In rows with zero spacing 0.14 - 2.5 mm ² / 0.14 - 2.5 mm ² / 26 - 14 6.2 mm / 80 mm / 86 mm

Ordering data

Type	Order No.	Pcs. / Pkt.
PLC-SC-ELR W1/ 2-24DC ¹⁾	2980539	1
PLC-SP-ELR W1/ 2-24DC ¹⁾	2980555	1

PLC-INTERFACE Pulse expansion module

- A solid-state relay for acquiring and extending short pulses.
- Pulse detection can be set from > 0.1 ms or > 2 ms
- Status display
- Delay times of 10 to 2550, can be set via DIP switches
- Bridging options
- Can be retriggered
- Screw and push-in connection technology



With DC voltage output
Max. 100 mA

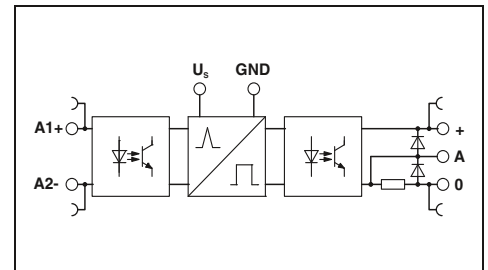

Technical data

Input data	
Rated control supply voltage U_s	24 V DC
Rated control supply voltage range with reference to U_s	0.8 ... 1.2
Rated control supply current I_s	
Input low, output low	13 mA
Input high, output high	19 mA
Rated actuating voltage U_c	24 V DC
Rated actuating current I_c	3 mA
Switching threshold "0" signal in reference to U_c	< 0.4
Switching threshold "1" signal in reference to U_c	> 0.8
Status indication	Yellow LED
Operating voltage display	Green LED
Input circuit	Protection against polarity reversal, Surge protection
Output data	
Output voltage range U_E	3 V DC ... 48 V DC
Limiting continuous current	100 mA
Voltage drop at max. limiting continuous current	< 1 V DC
Output circuit	3-conductor, ground-referenced
Output protection	Protection against polarity reversal, Surge protection, Free running
General data	
Rated insulation voltage	50 V DC
Rated surge voltage	0.5 kV
Ambient temperature (operation)	-25°C ... 60°C
Standards/regulations	DIN EN 50178
Connection data solid / stranded / AWG	0.14 - 2.5 mm ² / 0.14 - 2.5 mm ² / 26 - 14
Dimensions	6.2 mm / 80 mm / 86 mm

Ordering data

Description	Type	Order No.	Pcs. / Pkt.
PLC INTERFACE, with screw connection			
	PLC-OSC-LPE-24DC/48DC/100	2903171	1
PLC-INTERFACE, with push-in connection			
	PLC-OPT-LPE-24DC/48DC/100	2903173	1

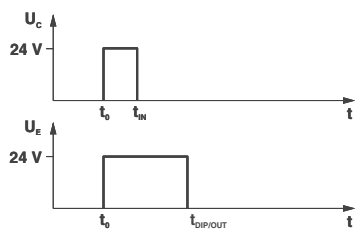

Input pulse $t_1 <$ set output pulse t_3
(no restart when triggered again)

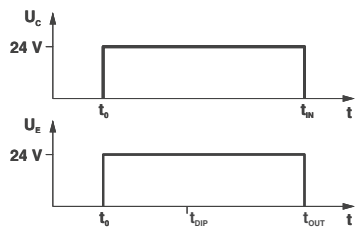

Input pulse $t_1 \geq$ set output pulse t_3 , then input pulse $t_1 =$ output pulse t_2
(no restart when triggered again)

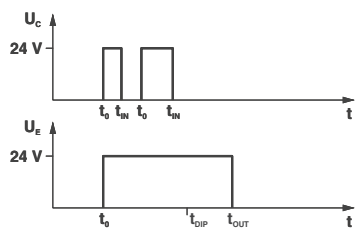

Input pulse $t_1 <$ set output pulse t_3
(restart when triggered again)

DIP							
S1	S2	S3	S4	S5	S6	S7	S8
10	-	-	-	-	-	-	-
-	20	-	-	-	-	-	-
-	-	40	-	-	-	-	-
-	-	-	80	-	-	-	-
-	-	-	-	160	-	-	-
-	-	-	-	-	320	-	-
-	-	-	-	-	-	640	-
-	-	-	-	-	-	-	1280

Relay modules

PLC series

PLC accessories

The **PLC-ESK** power terminal helps with supplying the bridge potentials; the **PLC-ATP** partition plate helps with optical and safe disconnection of the adjacent PLC modules. The **PLC-BP (A1-14)** passive feed-through bridge is used instead of a relay and connects the A1 and 14 terminal points.



Description	Color
Power terminal block , for supply of up to four potentials, with the same shape as PLC standard series, max. 32 A/250 V AC	
Separating plate , thickness 2 mm, required at the start and end of a PLC terminal strip. It is also used for visual separation of groups, safe isolation of different voltages of neighboring PLC interfaces as per DIN EN 50178/VDE0160, separation of neighboring bridges of different potentials, and separation of PLC interfaces at voltages > 250 V	gray
Screwdriver Blade: 0.6 x 3.5 x 100 mm, length: 181 mm	black
Passive feed-through bridge , can be plugged in instead of relay or solid-state relay, bridges terminal points A1 and 14	black

Ordering data		
Type	Order No.	Pcs. / Pkt.
PLC-ESK GY	2966508	5
PLC-ATP BK	2966841	25
SZF 1-0,6X3,5	1204517	10

Ordering data		
Type	Order No.	Pcs. / Pkt.
PLC-BP A1-14	2980283	10

PLC accessories

The colored isolated FBST plug-in bridges are not required for the PLC interface up to 70%. The 500 mm long **FBST 500-PLC** “endless bridges” are especially effective. The 2-pos. **FBST 6** single plug-in bridges are especially suited for bridging a smaller number of PLC modules.

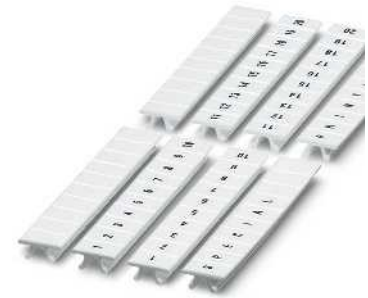
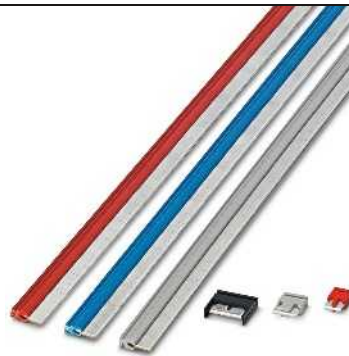

Description	Color
Cont. plug-in bridge , 500 mm long, isolated, can be cut to length, for potential distribution Nominal current: 32 A	red blue gray
Plug-in bridge , 2-pos., 6 mm long, for potential distribution Nominal current: 6 A	red blue gray
Plug-in bridge , 2-pos., 8 mm long, for potential distribution with a partition plate Nominal current: 6 A	gray
Plug-in bridge , 2-pos., 14 mm long, insulated, for potential distribution Nominal current: 10 A	black
Zack marker strip , printed horizontally, 10-section, with consecutive numbers, e.g., 1-10, 11-20, etc. up to 91-100	

Ordering data		
Type	Order No.	Pcs. / Pkt.
FBST 500-PLC RD	2966786	20
FBST 500-PLC BU	2966692	20
FBST 500-PLC GY	2966838	20
FBST 6-PLC RD	2966236	50
FBST 6-PLC BU	2966812	50
FBST 6-PLC GY	2966825	50
FBST 8-PLC GY	2967688	50
FBST 14-PLC BK	2967691	50

Ordering data		
Type	Order No.	Pcs. / Pkt.
ZB 6,LGS:FORTL.ZAHLEN	1051016	10

Adapter for PLC-INTERFACE

PLC-V8/... are VARIOFACE adapters which connect the 6.2 mm wide PLC RELAY modules to the VARIOFACE system cabling

Notes:
For cross-reference list with matching PLC-INTERFACE modules, see page 488

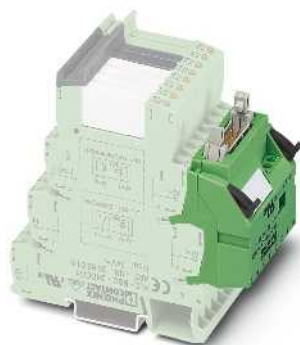

VARIOFACE adapter for 6.2 mm PLC-INTERFACE

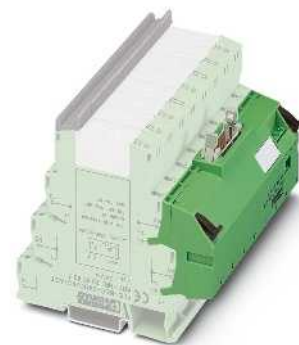

VARIOFACE adapter for 14 mm PLC-INTERFACE



Max. perm. operating voltage	
Max. perm. current (per branch)	
Max total current (voltage supply)	
Test voltage	
Ambient temperature (operation)	
Standards/regulations	
Connection method	Power supply
	Signal level
Connection data solid / stranded / AWG	
Dimensions	H / D

Technical data	
24 V DC ±25%	
1 A (per signal path)	
3 A	
500 V AC (50 Hz, 1 min.)	
-40°C ... 70°C	
IEC 60664, DIN EN 50178, IEC 62103	
Screw connection	
IDC/FLK pin strip (2.54 mm)	
0.2 ... 4 mm ² / 0.2 ... 2.5 mm ² / 24 - 12	
100 mm / 94 mm	

Technical data	
24 V DC ±25%	
1 A (per signal path)	
3 A	
500 V (50 Hz, 1 min.)	
-40°C ... 70°C	
IEC 60664, DIN EN 50178, IEC 62103	
Screw connection	
IDC/FLK pin strip (2.54 mm)	
0.2 ... 4 mm ² / 0.2 ... 2.5 mm ² / 24 - 12	
100 mm / 94 mm	

Description	No. of pos.	Module width W
V8 adapter , for 8 PLC interfaces (6.2 mm), with F LK connection, for PLC system cabling, positive switching		
OUTPUT	14	49.6 mm
INPUT	14	49.6 mm
V8 adapter , for 8 PLC interfaces (6.2 mm), with FLK connection, for PLC system cabling, negative switching		
OUTPUT	14	49.6 mm
INPUT	14	49.6 mm
V8 output adapter , for 8 PLC interfaces (6.2 mm), with 15-pos. D-SUB connection		
Pin strip	15	49.6 mm
Socket strip	15	49.6 mm
V8 input adapter , for 8 PLC interfaces (6.2 mm), with 15-pos. D-SUB connection		
Pin strip	15	49.6 mm
Socket strip	15	49.6 mm
V8 adapter , for 8 PLC interfaces (14 mm), with FLK connection, for PLC system cabling, positive switching	14	112.3 mm
V8 adapter , for 8 PLC interfaces (14 mm), with FLK connection, for PLC system cabling, negative switching	14	112.3 mm

Ordering data		
Type	Order No.	Pcs. / Pkt.
PLC-V8/FLK14/OUT	2295554	1
PLC-V8/FLK14/IN	2296553	1
PLC-V8/FLK14/OUT/M	2304102	1
PLC-V8/FLK14/IN/M	2304115	1
PLC-V8/D15S/OUT	2296058	1
PLC-V8/D15B/OUT	2296061	1
PLC-V8/D15S/IN	2296074	1
PLC-V8/D15B/IN	2296087	1

Ordering data		
Type	Order No.	Pcs. / Pkt.
PLC-V8L/FLK14/OUT	2299660	1
PLC-V8L/FLK14/OUT/M	2304306	1

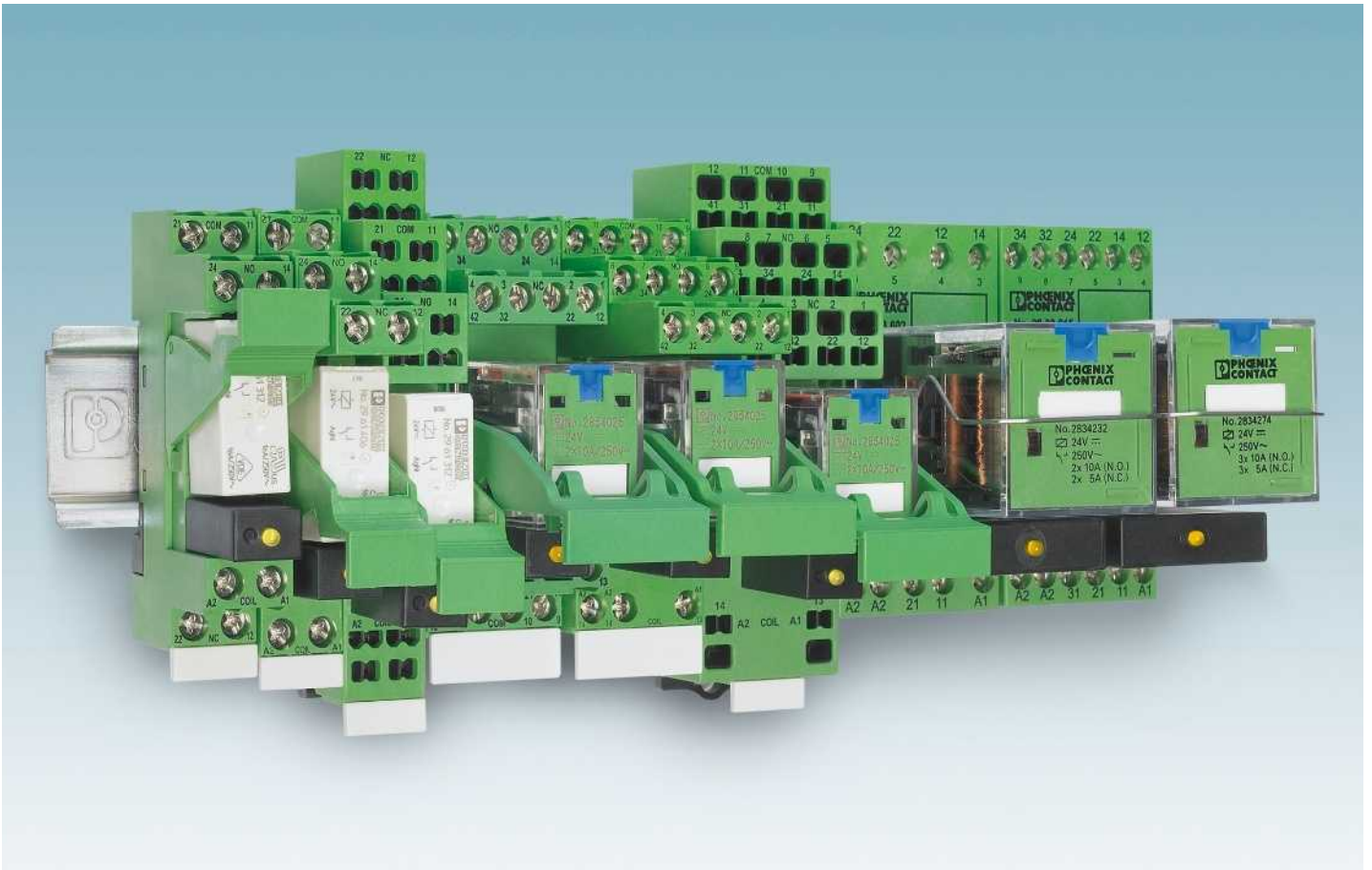

The PR series is a low-priced relay modular system, consisting of DIN rail bases, relays, plug-in input/interference suppression modules, engagement levers, and the matching marking labels and universal bridging materials for all bases. The modules are largely compatible with the usual standards on the market, have the major international approvals and are therefore accepted worldwide.

Besides the familiar relay bases with the screw connection method, relay bases with the spring-cage connection method for miniature power relays with one or two PDT contacts and for industrial relays with two or four PDT contacts are available in the PR series. The connections in these bases are configured with double spring cages for free, simple bridging of all potentials.

The PR series also boasts its own particular features:

- Relay retaining bracket: The EL... plastic relay retaining bracket, with which the relays can be held and, if necessary, ejected, have an exposed, smooth, large equipment marking area for standard self-adhesive labels that can be printed easily and inexpensively using standard printers. When fitted, the engagement lever is securely connected to the base, which means that the labeling cannot be lost.
- Industrial relays: All REL-IR... industrial relays have as standard an LED status display

and all DC types also have an integrated freewheeling diode. In most cases, this eliminates the plug-in input modules that are otherwise also used.

- Plug-in input modules with RC element: most standard input/interference suppression modules with an RC element used for compensation of interference coupling on long lines or in the event of leakage currents from electronic AC outputs have only low capacitance values. This greatly limits the filter effect. In contrast, the RC-120-230UC and RC3-120-230UC plug-in module series for mains voltage applications have a filter function that is improved up to a factor of 10. Unlike with the discharge resistors that are normally used for such applications, using RC plug-in modules gives rise to no additional heating!

**PR1 series**

The narrow 16 mm PR1 base series for relays with one or two contacts is available with a screw or spring-cage connection method. Both the traditional 2/2-level bases and two modern “logical” 1/3-level versions with fully opposite coil and contact connections are available.

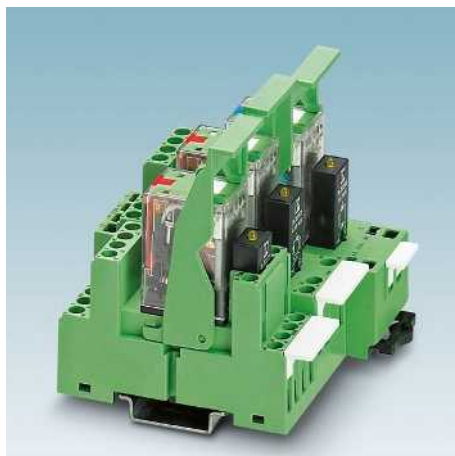
**PR2 series**

The PR2 base series accommodates plug-in industrial relays with two or four PDT contacts. Like the PR1 series, the bases are available with screw and spring-cage connection methods, as well as in the traditional 2/2-level and modern “logical” 1/3-level versions.

**PR3 series**

The robust octal relays with two or three PDT contacts that are widely used in some areas fit on the PR3 base with touch-protected screw connections. All the base connections have a wide connection cross section and are arranged on one level with good accessibility.

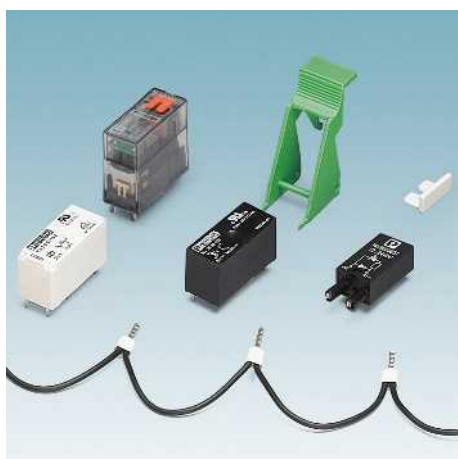

The active components of the PR1 modular system include various miniature power relays (optionally available with manual test function) and electronic solid-state relays. Matching relay retaining brackets with integrated marking area prevent them from being shaken loose. Depending on requirements, input/interference suppression modules with various functions can also be plugged in. Marking labels and loop bridges in various colors that are suitable for universal use with all PR bases complete the range of accessories.



The PR2 modular system is specifically designed for plug-in industrial relays. Industrial relays from Phoenix Contact feature the following as standard: a manual test button, switch position indicator, status LED, and freewheeling diode (DC coils only). Interference suppression modules with a varistor or RC element can also be plugged in as an option. Relay retaining brackets with integrated marking areas prevent the relays from being shaken loose. Marking labels and loop bridges in various colors that are suitable for universal use with all PR bases complete the range of accessories.

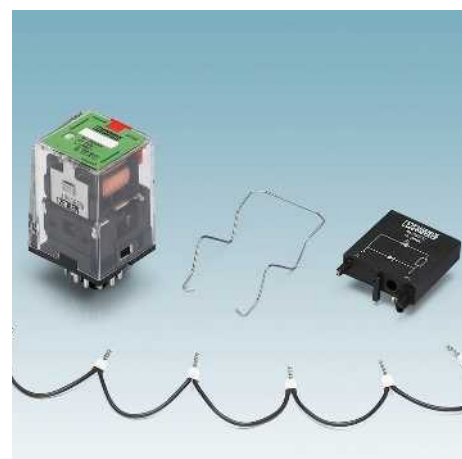

The PR3 modular system is specifically designed for the robust octal relays. The relays have a switch position indicator and a manual test button and there is a wire bracket to prevent them from being shaken loose. Input/interference suppression modules with various functions can also be plugged in as an option. The base can be marked with an 8 x 20 mm standard adhesive label. Loop bridges in various colors for universal use round off the range of accessories.

Relay modules

PR series

Modular PR1 relay base

Range of relay bases that can be fitted with 1 PDT or 2 PDT relay or solid-state relay

Range of accessories includes:

- Plug-in input modules/interference suppression modules
- Relay retaining bracket with labeling field and ejection function
- Marking labels
- Loop bridges

Notes:
Type of housing: Polyamide fiber reinforced PA-F, color: green.
Marking systems and mounting material See Catalog 5

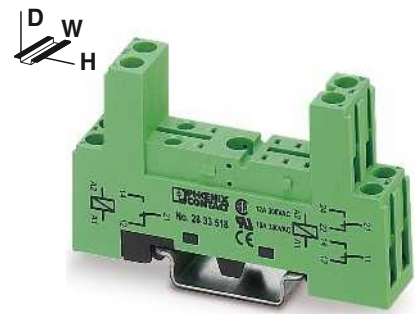

2/2-level design with screw connection

Nominal voltage U_N	300 V AC/DC
Nominal current at U_N	12 A
General data	
Ambient temperature (operation)	-25°C ... 85°C
Connection data solid / stranded / AWG	0.2 ... 2.5 mm ² / 0.2 ... 2.5 mm ² / 26 - 14
Dimensions	
Width	16 mm
Depth with retaining bracket	63 mm (EL1-P16) 71 mm (EL1-P25)
Height	75 mm



Technical data

Nominal voltage U_N	300 V AC/DC
Nominal current at U_N	12 A
General data	
Ambient temperature (operation)	-25°C ... 85°C
Connection data solid / stranded / AWG	0.2 ... 2.5 mm ² / 0.2 ... 2.5 mm ² / 26 - 14
Dimensions	
Width	16 mm
Depth with retaining bracket	63 mm (EL1-P16) 71 mm (EL1-P25)
Height	75 mm

Ordering data

Description
Relay base PR1 , 2/2-level design, plug-in option for input/interference suppression module, safe isolation I/O, including ten MP1 marking labels per pack
With screw connection Relay base PR1 , 1/3-level design, plug-in option for input/interference suppression module, safe isolation I/O, including ten MP1 marking labels per pack
With screw connection Relay base PR1 , 1/3-level design, plug-in option for input/interference suppression module, safe isolation I/O, including ten MP1 marking labels per pack
With spring-cage connection Relay retaining bracket , with ejector function and integrated equipment marking area (7.5 x 15 mm), suitable for relay socket PR1
for 16 mm tall miniature power relay and solid-state relay
for 25 mm tall miniature switching relay and solid-state relay

Type	Order No.	Pcs. / Pkt.
PR1-BSC2/2X21	2833518	10
EL1-P16	2833547	10
EL1-P25	2833550	10

Accessories

Equipment marking label , labeling surface 6 x 15 mm	
Device marking label , for thermal transfer printer, labeling surface 6 x 15 mm 2500 labels per roll	
Loop bridge , 50-pos., divisible, max. bridging distance 60 mm, 0.5 mm ²	blue black gray

MP 1	2833631	10
EML (15X6) R YE	0819288	1
DB 50- 90 BU	2821180	1
DB 50- 90 BK	2820916	1
DB 50- 90 GY	2820929	1

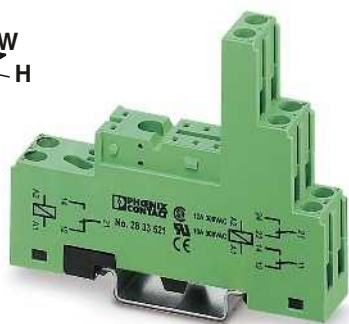

1/3-level design with screw connection

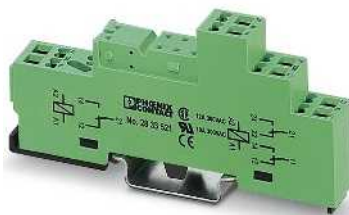

1/3-level design with spring-cage connection



Relay retaining bracket



Technical data		
300 V AC/DC		
12 A		
-25°C ... 85°C		
0.2 ... 2.5 mm ² / 0.2 ... 2.5 mm ² / 26 - 14		
16 mm		
71 mm (EL1-P16)		
79 mm (EL1-P25)		
78.5 mm		

Technical data		
300 V AC/DC		
10 A		
-25°C ... 85°C		
0.5 ... 1.5 mm ² / 0.5 ... 1.5 mm ² / 26 - 16		
16 mm		
72 mm (EL1-P16)		
80 mm (EL1-P25)		
97 mm		

Technical data		
-		
-		
-		
-		
-		
-		

Ordering data		
Type	Order No.	Pcs. / Pkt.
PR1-BSC3/2X21	2833521	10
EL1-P16	2833547	10
EL1-P25	2833550	10

Ordering data		
Type	Order No.	Pcs. / Pkt.
PR1-BSP3/2X21	2833534	10
EL1-P16	2833547	10
EL1-P25	2833550	10

Ordering data		
Type	Order No.	Pcs. / Pkt.
EL1-P16	2833547	10
EL1-P25	2833550	10

Accessories		
Type	Order No.	Pcs. / Pkt.
MP 1	2833631	10
EML (15X6) R YE	0819288	1
DB 50- 90 BU	2821180	1
DB 50- 90 BK	2820916	1
DB 50- 90 GY	2820929	1

Accessories		
Type	Order No.	Pcs. / Pkt.
MP 1	2833631	10
EML (15X6) R YE	0819288	1
DB 50- 90 BU	2821180	1
DB 50- 90 BK	2820916	1
DB 50- 90 GY	2820929	1

Accessories		
Type	Order No.	Pcs. / Pkt.

Relay modules

PR series

Plug-in miniature power relays

Plug-in miniature power relays with 1 or 2 PDT contacts, suitable for RIF-1, PR1, and PLC-INTERFACE relay bases.

The advantages:

- Power contacts up to 16 A
- Multi-layer gold contact or power contact
- High degree of protection up to RT III (comparable with IP67) depending on type



1 PDT relay



2 PDT relay

Notes:
If the specified maximum values for multi-layer contact relays are exceeded, the gold plating is destroyed. The maximum values of the power contact relay are then valid. This can result in a shorter service life than with a pure power contact.

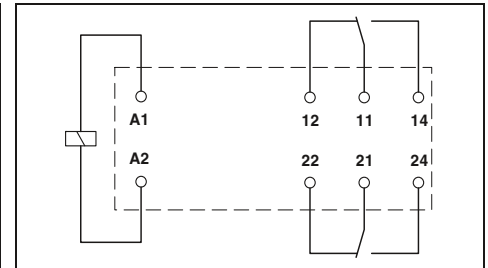
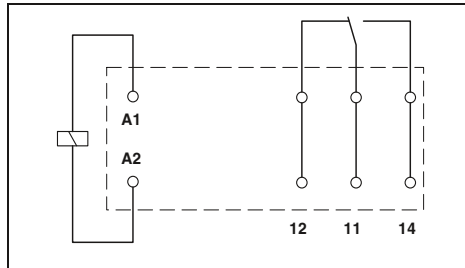

Input data	
Permissible range (with reference to U_N)	
Typ. input current at U_N	[mA]
Typ. response time at U_N	[ms]
Typ. response time at U_N (depending on phase relation)	[ms]
Typ. release time at U_N	[ms]
Typ. release time at U_N (depending on phase relation)	[ms]
Output data	
Contact type	
Contact material	
Max. switching voltage	
Min. switching voltage	
Limiting continuous current	
Max. inrush current	
Min. switching current	
Max. interrupting rating, ohmic load	250 V AC
General data	
Test voltage (winding / contact)	
Test voltage (contact/contact)	
Ambient temperature (operation)	
Mechanical service life	
Electrical service life	
Standards/regulations	

Technical data							
①	②	③	④	⑤	⑥	⑦	⑧
refer to the diagram							
33	17	8.7	8.2	4.1	32	7	3
7	7	7	7	7	3-12	3-12	3-12
3	3	3	3	3	2-9	2-9	2-9
Single contact, 1-PDT		Single contact, 1-PDT					
AgNi		AgNi, hard gold-plated					
250 V AC/DC		30 V AC / 36 V DC					
12 V (at 10 mA)		100 mV (at 10 mA)					
16 A		50 mA					
25 A (20 ms)		50 mA					
10 mA (at 12 V)		1 mA (at 24 V)					
4000 VA		-					
5 kV AC (50 Hz, 1 min.)		-					
-		-					
-40°C ... 85°C		-					
1 x 10 ⁷ cycles		-					
See diagram		-					
IEC 60664, EN 50178, IEC 62103		-					

Technical data							
①	②	③	④	⑤	⑥	⑦	⑧
refer to the diagram							
33	17	8.7	8.2	4.1	32	7	3
7	7	7	7	7	3-12	3-12	3-12
3	3	3	3	3	2-9	2-9	2-9
Single contact, 2-PDT		Single contact, 2-PDT					
AgNi		AgNi, hard gold-plated					
250 V AC/DC		30 V AC / 36 V DC					
5 V (at 10 mA)		100 mV (at 10 mA)					
8 A		50 mA					
12 A (20 ms)		50 mA					
10 mA (At 5 V)		1 mA (at 24 V)					
2000 VA		-					
5 kV AC (50 Hz, 1 min.)		2.5 kV AC (50 Hz, 1 min.)					
-		-					
-40°C ... 85°C		-					
1 x 10 ⁷ cycles		-					
See diagram		-					
IEC 60664, EN 50178, IEC 62103		-					

Ordering data	
Description	Input voltage U_N
Plug-in miniature power relays	
with power contact	① 12 V DC
with power contact	② 24 V DC
with power contact	③ 48 V DC
with power contact	④ 60 V DC
with power contact	⑤ 110 V DC
with power contact	⑥ 24 V AC
with power contact	⑦ 120 V AC
with power contact	⑧ 230 V AC
Plug-in miniature power relays	
with gold contact	① 12 V DC
with gold contact	② 24 V DC
with gold contact	③ 48 V DC
with gold contact	④ 60 V DC
with gold contact	⑤ 110 V DC
with gold contact	⑥ 24 V AC
with gold contact	⑦ 120 V AC
with gold contact	⑧ 230 V AC

Type	Order No.	Pcs. / Pkt.
REL-MR- 12DC/21HC	2961309	10
REL-MR- 24DC/21HC	2961312	10
REL-MR- 48DC/21HC	2834821	10
REL-MR- 60DC/21HC	2961325	10
REL-MR-110DC/21HC	2961338	10
REL-MR- 24AC/21HC	2961406	10
REL-MR-120AC/21HC	2961419	10
REL-MR-230AC/21HC	2961422	10
REL-MR- 12DC/21HC AU	2961532	10
REL-MR- 24DC/21HC AU	2961545	10
REL-MR-110DC/21HC AU	2961561	10
REL-MR- 24AC/21HC AU	2961503	10
REL-MR-120AC/21HC AU	2961516	10
REL-MR-230AC/21HC AU	2961529	10

Ordering data		
Type	Order No.	Pcs. / Pkt.
REL-MR- 12DC/21-21	2961257	10
REL-MR- 24DC/21-21	2961192	10
REL-MR- 48DC/21-21	2834834	10
REL-MR- 60DC/21-21	2961273	10
REL-MR-110DC/21-21	2961202	10
REL-MR- 24AC/21-21	2961435	10
REL-MR-120AC/21-21	2961448	10
REL-MR-230AC/21-21	2961451	10
REL-MR- 12DC/21-21AU	2961299	10
REL-MR- 24DC/21-21AU	2961215	10
REL-MR- 48DC/21-21AU	2834847	10
REL-MR- 60DC/21-21AU	2961286	10
REL-MR-110DC/21-21AU	2961228	10
REL-MR- 24AC/21-21AU	2961464	10
REL-MR-120AC/21-21AU	2961477	10
REL-MR-230AC/21-21AU	2961480	10

REL-MR...21HC... (1 PDT)

Operating voltage range

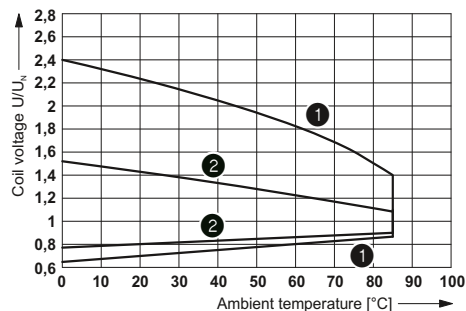

- 1 DC coils
- 2 AC coils

Interrupting rating

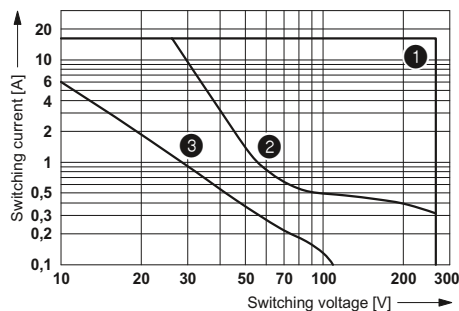

- 1 AC, ohmic load
- 2 DC, ohmic load
- 3 DC, L/R = 40 ms

Electrical service life

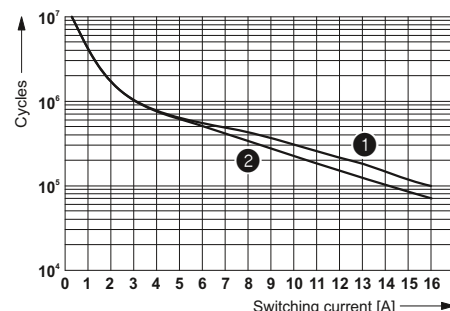

- 1 250 V AC, ohmic load (DC coils)
- 2 250 V AC, ohmic load (AC coils)

Service life reduction factor with various cos phi

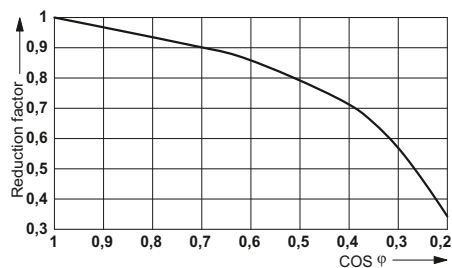

REL-MR...21-21... (2 PDTs)

Operating voltage range

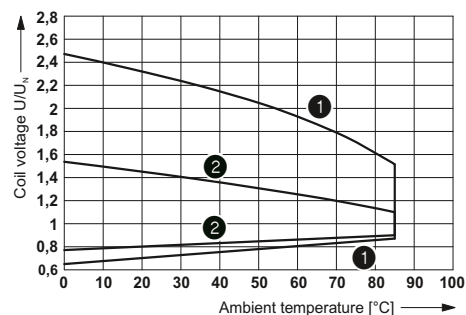

- 1 DC coils
- 2 AC coils

Interrupting rating

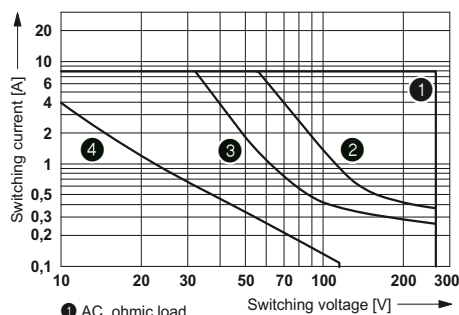

- 1 AC, ohmic load
- 2 DC, ohmic load, contacts in series
- 3 DC, ohmic load
- 4 DC, L/R = 40 ms

Electrical service life

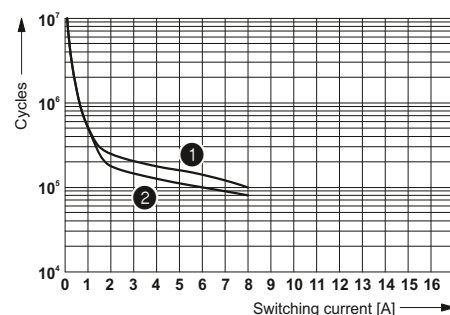

- 1 250 V AC, ohmic load (DC coils)
- 2 250 V AC, ohmic load (AC coils)

Service life reduction factor with various cos phi

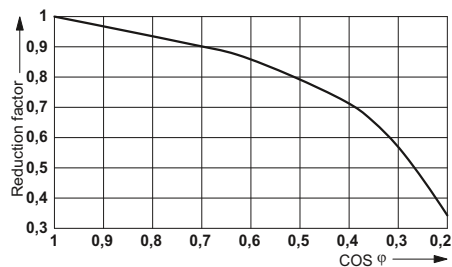

Relay modules

PR series

Plug-in miniature power relays

Plug-in miniature power relays with 1 or 2 PDT contacts, suitable for RIF-1 and PR1 relay bases.

The advantages:

- Switching current of up to 16 A
- With lockable manual operation
- Mechanical switch position indicator
- Integrated status LED
- Multi-layer gold contact or power contact
- DC types with integrated freewheeling diode
- Can be soldered in on PCB



1 PDT relay



2 PDT relay

Notes:

If the specified maximum values for multi-layer contact relays are exceeded, the gold plating is destroyed. The maximum values of the power contact relay are then valid. This can result in a shorter service life than with a pure power contact.

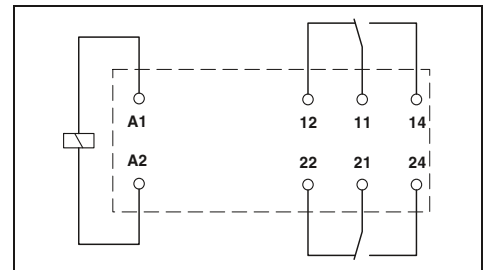
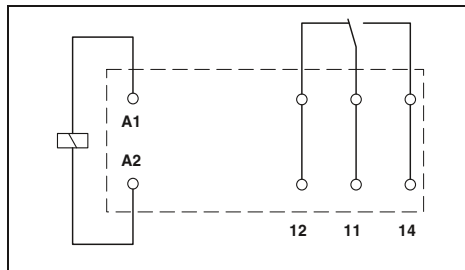

Technical data

①	②	③	④
refer to the diagram			
18	32	7	3.5
9		3 - 12	3 - 12
6		2 - 8	2 - 8

Technical data

①	②	③	④
refer to the diagram			
18	32	7	3.5
9		3 - 12	3 - 12
6		2 - 8	2 - 8

Input data	
Permissible range (with reference to U_N)	
Typ. input current at U_N	[mA]
Typ. response time at U_N	[ms]
Typ. response time at U_N (depending on phase relation)	[ms]
Typ. release time at U_N	[ms]
Typ. release time at U_N (depending on phase relation)	[ms]
Output data	
Contact type	
Contact material	
Max. switching voltage	
Min. switching voltage	
Limiting continuous current	
Max. inrush current	
Min. switching current	
Max. interrupting rating, ohmic load	250 V AC
General data	
Test voltage (winding / contact)	
Test voltage (contact/contact)	
Ambient temperature (operation)	
Mechanical service life	
Electrical service life	
Standards/regulations	

Technical data	
Single contact, 1-PDT	Single contact, 1-PDT
AgNi	AgNi, hard gold-plated
250 V AC/DC	30 V AC / 36 V DC
12 V (at 10 mA)	12 V (At 1 mA)
16 A	50 mA
32 A (20 ms)	50 mA
10 mA (at 12 V)	1 mA (at 12 V)
4000 VA	-
5 kV AC (50 Hz, 1 min.)	
-	
-40°C ... 70°C	
5 x 10 ⁶ cycles	
See diagram	
DIN EN 61810-1, VDE 0435-201, EN 50178, IEC 62103	

Technical data	
Single contact, 2-PDT	Single contact, 2-PDT
AgNi	AgNi, hard gold-plated
250 V AC/DC	30 V AC / 36 V DC
12 V (at 10 mA)	12 V (At 1 mA)
8 A	50 mA
16 A (20 ms)	50 mA
10 mA (at 12 V)	1 mA (at 12 V)
2000 VA	-
5 kV AC (50 Hz, 1 min.)	
2.5 kV AC (50 Hz, 1 min.)	
-40°C ... 70°C	
5 x 10 ⁶ cycles	
See diagram	
DIN EN 61810-1, VDE 0435-201, EN 50178, IEC 62103	

Ordering data

Description	Input voltage U_N
Plug-in miniature power relays, with power contacts	
- Status LED, freewheeling diode A1+, A2-	① 24 V DC
- Status LED	② 24 V AC
- Status LED	③ 120 V AC
- Status LED	④ 230 V AC
Plug-in miniature power relays with manual test function, with hard gold-plated multi-layer contacts, mechanical switch position indicator	
- Status LED, freewheeling diode A1+, A2-	① 24 V DC
- Status LED	④ 230 V AC

Type	Order No.	Pcs. / Pkt.
REL-MR- 24DC/21HC/MS	2987888	10
REL-MR- 24AC/21HC/MS	2987891	10
REL-MR-120AC/21HC/MS	2987901	10
REL-MR-230AC/21HC/MS	2987914	10
REL-MR- 24DC/21HC AU/MS	2987927	10
REL-MR-230AC/21HC AU/MS	2987930	10

Ordering data

Type	Order No.	Pcs. / Pkt.
REL-MR- 24DC/21-21/MS	2987943	10
REL-MR- 24AC/21-21/MS	2987956	10
REL-MR-120AC/21-21/MS	2987969	10
REL-MR-230AC/21-21/MS	2987972	10
REL-MR- 24DC/21-21AU/MS	2987985	10
REL-MR-230AC/21-21AU/MS	2987998	10

REL-MR...21HC...MS (1 PDT)

Operating voltage range

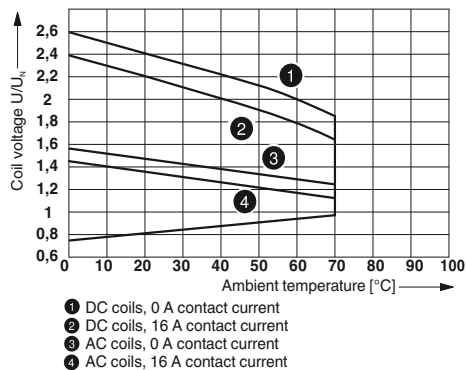

Interrupting rating

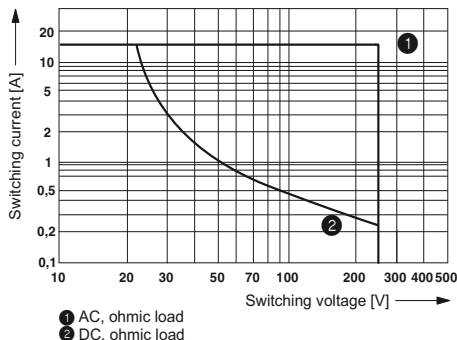

Electrical service life

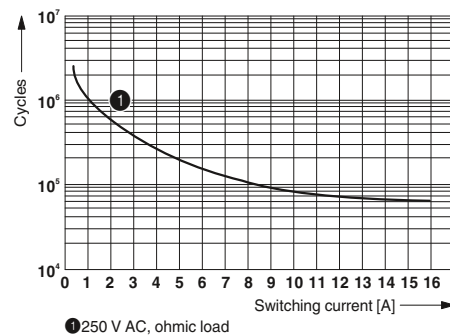

Service life reduction factor with various cos phi

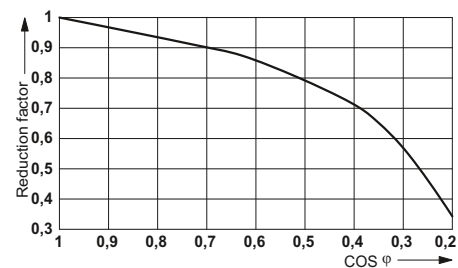

REL-MR...21-21...MS (2 PDTs)

Operating voltage range

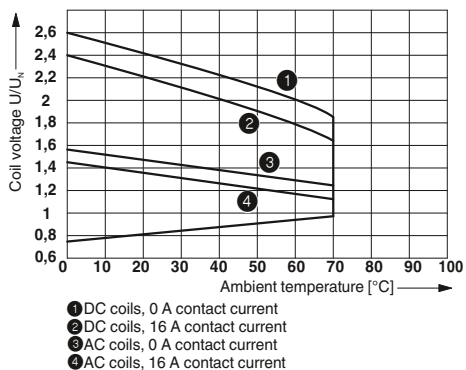

Interrupting rating

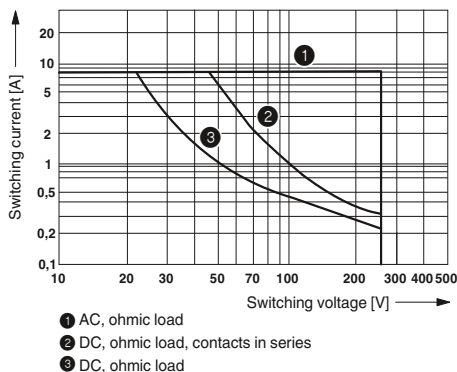

Electrical service life

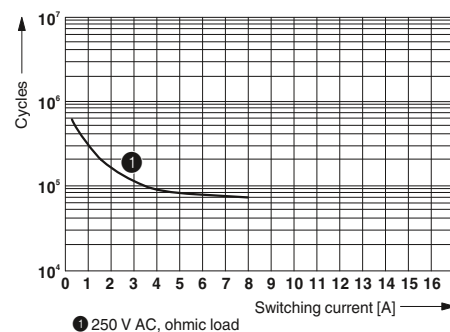

Service life reduction factor with various cos phi

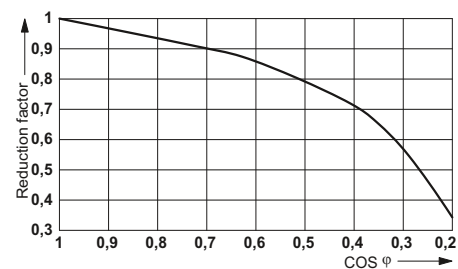

Relay modules

PR series

Modular PR2 relay base

Range of relay bases that can be fitted with 2 PDT or 4 PDT relays

Range of accessories includes:

- Plug-in input modules/interference suppression modules
- Relay retaining bracket with labeling field and ejection function
- Marking labels
- Loop bridges

Notes:
Type of housing: Polyamide fiber reinforced PA-F, color: green.
Marking systems and mounting material See Catalog 5

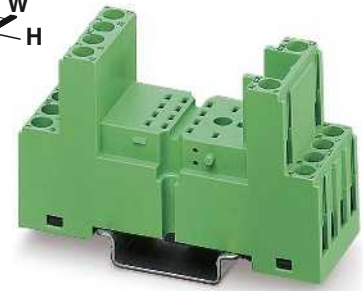

2/2-level design with screw connection

Technical data	
Nominal voltage U_N	300 V AC/DC
Nominal current at U_N	12 A
General data	
Ambient temperature (operation)	-25°C ... 85°C
Connection data solid / stranded / AWG	0.2 ... 1.5 mm ² / 0.2 ... 1.5 mm ² / 26 - 16
Dimensions	
Width	27 mm
Depth with retaining bracket	84 mm (EL2-P35)
Height	75 mm

Description	
Relay base PR2-B , for industrial relay, REL-IR with two or four PDTs, 2/2-level design, connection option for input/interference suppression module, including ten MP2 marking labels per packaging	
With screw connection	
Relay base PR2-B , for industrial relay, REL-IR with two or four PDTs, 1/3-level design, connection option for input/interference suppression module, including ten MP2 marking labels per packaging	
With screw connection	
Relay base PR2-B , for industrial relay, REL-IR with two or four PDTs, 1/3-level design, connection option for input/interference suppression module, including ten MP1 marking labels per packaging	
With spring-cage connection	
Relay retaining bracket , with eject function and integrated device marking area (8 x 25 mm), to suit relay base PR2, for 35 mm high industrial relay	



Ordering data		
Type	Order No.	Pcs. / Pkt.
PR2-BSC2/4X21	2833563	10
EL2-P35	2833592	10

Equipment marking label , labeling surface 6 x 15 mm		
Equipment marking label , labeling surface 9 x 25 mm		
Device marking label , for thermal transfer printer, labeling surface 6 x 15 mm 2500 labels per roll		
Loop bridge , 50-pos., divisible, max. bridging distance 60 mm, 0.5 mm ²		
blue	DB 50- 90 BU	2821180
black	DB 50- 90 BK	2820916
gray	DB 50- 90 GY	2820929

Accessories		
Type	Order No.	Pcs. / Pkt.
MP 2	2833644	10
EML (15X6) R YE	0819288	1
DB 50- 90 BU	2821180	1
DB 50- 90 BK	2820916	1
DB 50- 90 GY	2820929	1

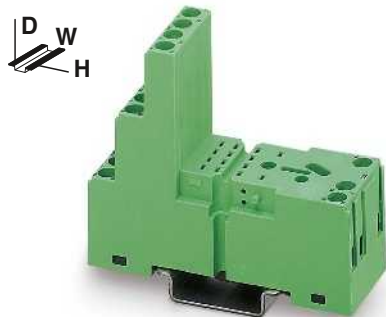

1/3-level design with screw connection

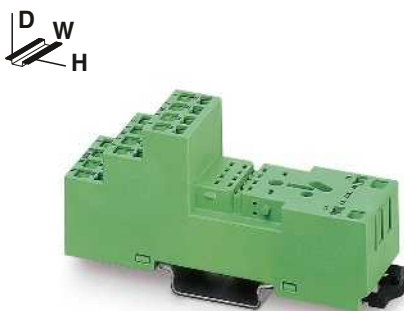

1/3-level design with spring-cage connection



Relay retaining bracket



Technical data		
300 V AC/DC		
12 A		
-25°C ... 85°C		
0.2 ... 1.5 mm ² / 0.2 ... 1.5 mm ² / 26 - 16		
27 mm		
86 mm (EL2-P35)		
78.5 mm		

Technical data		
300 V AC/DC		
10 A		
-25°C ... 85°C		
0.2 ... 1.5 mm ² / 0.2 ... 1.5 mm ² / 24 - 16		
31 mm		
84 mm (EL2-P35)		
95 mm		

Technical data		
-		
-		
-		
-		
-		
-		

Ordering data		
---------------	--	--

Ordering data		
---------------	--	--

Ordering data		
---------------	--	--

Type	Order No.	Pcs. / Pkt.
PR2-BSC3/4X21	2833576	10
EL2-P35	2833592	10

Type	Order No.	Pcs. / Pkt.
PR2-BSP3/4X21	2833589	10
EL2-P35	2833592	10

Type	Order No.	Pcs. / Pkt.
EL2-P35	2833592	10

Accessories		
-------------	--	--

Accessories		
-------------	--	--

Accessories		
-------------	--	--

MP 2	2833644	10
EML (15X6) R YE	0819288	1
DB 50- 90 BU	2821180	1
DB 50- 90 BK	2820916	1
DB 50- 90 GY	2820929	1

MP 1	2833631	10
EML (15X6) R YE	0819288	1
DB 50- 90 BU	2821180	1
DB 50- 90 BK	2820916	1
DB 50- 90 GY	2820929	1

Relay modules

PR series

Plug-in industrial relays suitable for PR2 relay base

Plug-in industrial relays with 2 or 4 PDT contacts, suitable for PR2 and RIF-2 relay bases.

The advantages:

- Lockable manual operation
- Mechanical switch position indicator
- Integrated status LED
- Multi-layer gold contact or power contact
- DC types with integrated freewheeling diode



2 PDT relay with power contacts



4 PDT relay with multi-layer gold contact

Notes:
For 48 V DC and 60 V DC types, see www.phoenixcontact.net/products

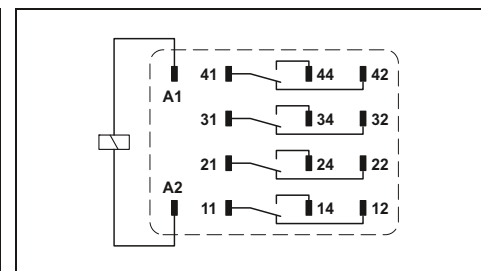
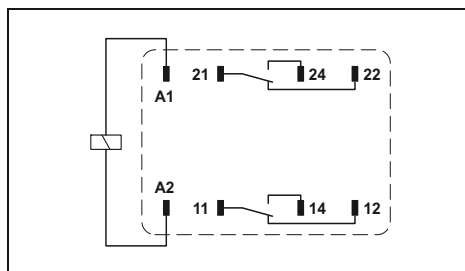

Technical data

①	②	③	④	⑤	⑥	⑦	⑧
refer to the diagram							
75	38	10	7.2	3.6	54	11	5
13	13	13	13	13			
					4 - 10	4 - 10	4 - 10
5	5	5	5	5			
					3 - 12	3 - 12	3 - 12

Technical data

①	②	③	④	⑤	⑥	⑦	⑧
refer to the diagram							
75	38	10	7.2	3.6	54	11	5
13	13	13	13	13			
					4 - 10	4 - 10	4 - 10
5	5	5	5	5			
					3 - 12	3 - 12	3 - 12

Input data	
Permissible range (with reference to U_N)	
Typ. input current at U_N	[mA]
Typ. response time at U_N	[ms]
Typ. response time at U_N (AC, depending on phase relation)	[ms]
Typ. release time at U_N	[ms]
Typ. release time at U_N (AC, depending on phase relation)	[ms]
Output data	
Contact type	Single contact, 2-PDT
Contact material	Ag
Max. switching voltage	250 V AC/DC
Min. switching voltage	5 V
Limiting continuous current	10 A
Min. switching current	1 mA
Max. interrupting rating, ohmic load	250 V AC

Single contact, 2-PDT
Ag
250 V AC/DC
5 V
10 A
1 mA
250 V VA

Single contact, 4-PDT
AgNi, hard gold-plated
250 V AC/DC
1 V
5 A
1 mA
1250 VA

General data	
Test voltage (winding / contact)	2 kV AC (50 Hz, 1 min.)
Test voltage (contact/contact)	2 kV AC (50 Hz, 1 min.)
Ambient temperature (operation)	-55°C ... 70°C
Nominal operating mode	100% operating factor
Mechanical service life	5 x 10 ⁷ cycles
Electrical service life	See diagram
Standards/regulations	DIN EN 61810-1, VDE 0435-201, EN 50178, IEC 62103

Any / On relay base PR2

Any / On relay base PR2

Ordering data

Description	Input voltage U_N
Plug-in industrial relay with a test button, status LED, mechanical switch position indicator	
with freewheeling diode, A1 +, A2 -	① 12 V DC
with freewheeling diode, A1 +, A2 -	② 24 V DC
with freewheeling diode, A1 +, A2 -	③ 110 V DC
with freewheeling diode, A1 +, A2 -	④ 125 V DC
with freewheeling diode, A1 +, A2 -	⑤ 220 V DC
	⑥ 24 V AC
	⑦ 120 V AC
	⑧ 230 V AC
Plug-in industrial relay with a test button, status LED, mechanical switch position indicator (Japanese standard)	
with freewheeling diode, A1 -, A2 +	① 12 V DC
with freewheeling diode, A1 -, A2 +	② 24 V DC
with freewheeling diode, A1 -, A2 +	③ 48 V DC
with freewheeling diode, A1 -, A2 +	④ 110 V DC

Type	Order No.	Pcs. / Pkt.
REL-IR/LDP- 12DC/2X21	2834012	10
REL-IR/LDP- 24DC/2X21	2834025	10
REL-IR/LDP-110DC/2X21	2834041	10
REL-IR/LDP-125DC/2X21	2834960	10
REL-IR/LDP-220DC/2X21	2834957	10
REL-IR/L- 24AC/2X21	2834054	10
REL-IR/L-120AC/2X21	2834067	10
REL-IR/L-230AC/2X21	2834070	10
REL-IR/LDM- 12DC/2X21	2834151	10
REL-IR/LDM- 24DC/2X21	2834164	10
REL-IR/LDM- 48DC/2X21	2834177	10
REL-IR/LDM-110DC/2X21	2834180	10

Ordering data

Type	Order No.	Pcs. / Pkt.
REL-IR/LDP- 12DC/4X21AU	2834083	10
REL-IR/LDP- 24DC/4X21AU	2834096	10
REL-IR/LDP-110DC/4X21AU	2834119	10
REL-IR/LDP-125DC/4X21AU	2834313	10
REL-IR/LDP-220DC/4X21AU	2834973	10
REL-IR/L- 24AC/4X21AU	2834122	10
REL-IR/L-120AC/4X21AU	2834135	10
REL-IR/L-230AC/4X21AU	2834148	10
REL-IR/LDM- 12DC/4X21AU	2834193	10
REL-IR/LDM- 24DC/4X21AU	2834203	10
REL-IR/LDM- 48DC/4X21AU	2834216	10
REL-IR/LDM-110DC/4X21AU	2834229	10

REL-IR...2x21 (2 PDTs)

Operating voltage range

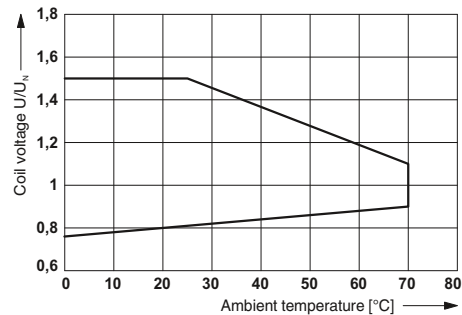

AC interrupting rating

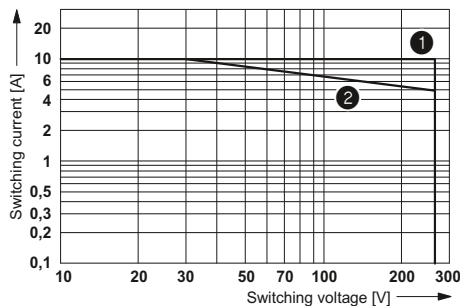

- 1 Ohmic load
- 2 $\cos \varphi = 0.4$

DC interrupting rating

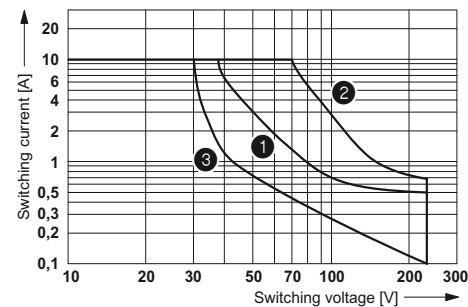

- 1 Ohmic load
- 2 ohmic load, contacts in series
- 3 $L/R < 7$ ms

Electrical service life

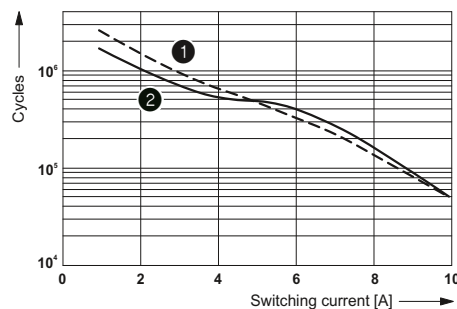

- 1 250 V AC, ohmic load
- 2 30 V DC, ohmic load

Service life reduction factor

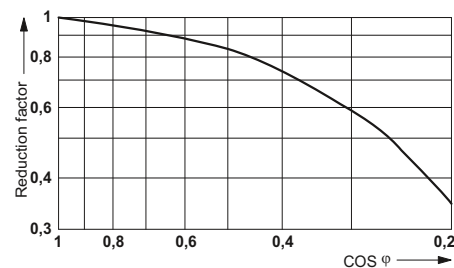

REL-IR...4x21AU (4 PDTs)

Operating voltage range

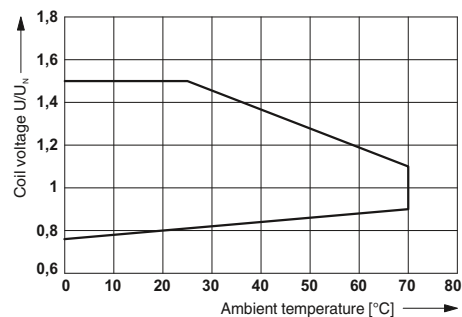

AC interrupting rating

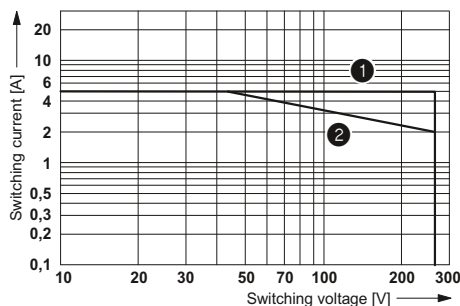

- 1 Ohmic load
- 2 $\cos \varphi = 0.4$

DC interrupting rating

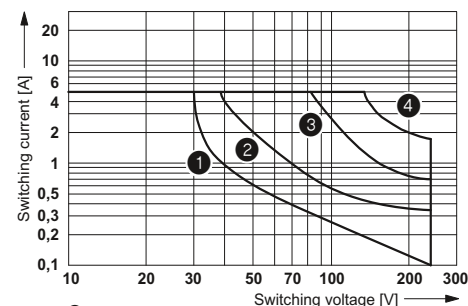

- 1 $L/R < 7$ ms
- 2 ohmic load
- 3 ohmic load, 2 contacts in series
- 4 ohmic load, 4 contacts in series

Electrical service life

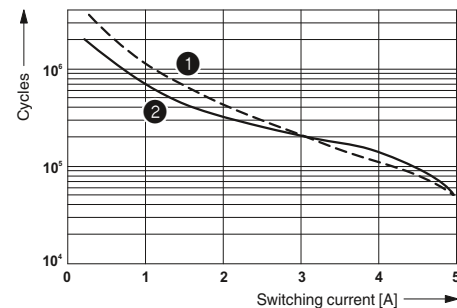

- 1 250 V AC, ohmic load
- 2 30 V DC, ohmic load

Service life reduction factor

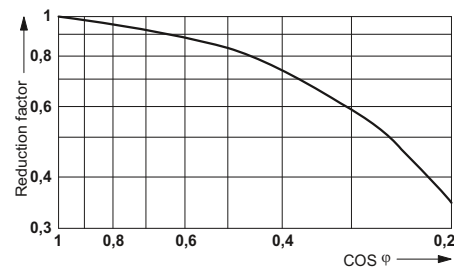

Relay modules

PR series

Modular PR3 relay base

Range of relay bases that can be fitted with 2 PDT or 3 PDT relays

Range of accessories includes:

- Plug-in input modules/interference suppression modules
- Relay retaining bracket
- Loop bridges

Notes:
Type of housing: Polyamide fiber reinforced PA-F, color: green.
Marking systems and mounting material See Catalog 5

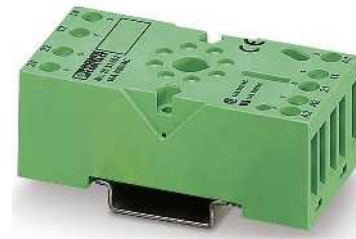

Relay base for 2 PDT octal relay

Technical data	
Nominal voltage U_N	400 V AC/DC
Nominal current at U_N	10 A
General data	
Ambient temperature (operation)	-40°C ... 85°C
Connection data solid / stranded / AWG	0.2 ... 2.5 mm ² / 0.2 ... 2.5 mm ² / 26 - 14
Dimensions	
Width	38 mm
Depth with retaining bracket	84 mm (EL3-M52)
Height	75 mm

Ordering data		
Type	Order No.	Pcs. / Pkt.
Relay base PR3 , for octal relay REL-OR with two PDTs, plug-in option for input/interference suppression modules		
With screw connection		
Relay base PR3 , for octal relay REL-OR with three PDTs, plug-in option for input/interference suppression modules		
With screw connection		
Relay retaining bracket , wiring to suit relay base PR3, for 52 mm high octal relay		
PR3-BSC1/2X21	2833602	10
EL3-M52	2833628	10

Accessories				
Loop bridge , 50-pos., divisible, max. bridging distance 60 mm, 0.5 mm ²	blue	DB 50- 90 BU	2821180	1
	black	DB 50- 90 BK	2820916	1
	gray	DB 50- 90 GY	2820929	1



Relay base for
3 PDT octal relay



Relay retaining bracket



Technical data			Technical data		
400 V AC/DC			-		
10 A			-		
-40°C ... 85°C			-		
0.2 ... 2.5 mm ² / 0.2 ... 2.5 mm ² / 26 - 14			-		
38 mm			-		
84 mm (EL3-M52)			-		
75 mm			-		
Ordering data			Ordering data		
Type	Order No.	Pcs. / Pkt.	Type	Order No.	Pcs. / Pkt.
PR3-BSC1/3X21	2833615	10			
EL3-M52	2833628	10	EL3-M52	2833628	10
Accessories			Accessories		
DB 50- 90 BU	2821180	1			
DB 50- 90 BK	2820916	1			
DB 50- 90 GY	2820929	1			

Relay modules

PR series

Plug-in octal relays suitable for PR3 relay base

Plug-in octal relays with 2 or 3 PDT contacts, suitable for PR3 and RIF-3 relay bases.

The advantages:

- Lockable manual operation
- Mechanical switch position indicator
- Extremely robust design



2 PDT relay with power contacts



3 PDT relay with power contacts

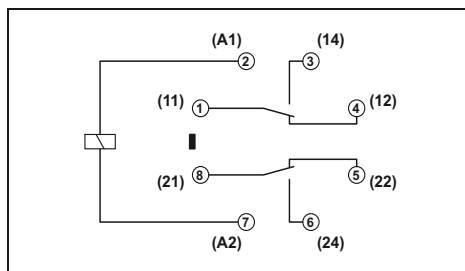

Technical data

Input data		①	②	③	④
Typ. input current at U_N	[mA]	56	110	22	10
Typ. response time at U_N	[ms]	12			
Typ. response time at U_N (AC, depending on phase relation)	[ms]		5 - 20	5 - 20	5 - 20
Typ. release time at U_N	[ms]	6			
Typ. release time at U_N (AC, depending on phase relation)	[ms]		5 - 20	5 - 20	5 - 20

Output data	
Contact type	Single contact, 2-PDT
Contact material	AgSnIn
Max. switching voltage	250 V AC/DC
Min. switching voltage	1 V
Limiting continuous current	10 A (N/O contact)
Min. switching current	10 mA
Max. interrupting rating, ohmic load	2500 VA

General data	
Test voltage (winding / contact)	2.5 kV AC (50 Hz, 1 min.)
Test voltage (contact/contact)	2.5 kV AC (50 Hz, 1 min.)
Ambient temperature (operation)	-40°C ... 60°C
Nominal operating mode	100% operating factor
Mechanical service life	10 x 10 ⁶ cycles
Electrical service life	See diagram
Standards/regulations	IEC 60664
Mounting position/mounting	Any / On relay base PR3

Ordering data

Description	Input voltage U_N
Plug-in octal relay with power contacts , with a test button and mechanical switch position indicator	① 24 V DC
	② 24 V AC
	③ 120 V AC
	④ 230 V AC

Type	Order No.	Pcs. / Pkt.
REL-OR- 24DC/2X21	2834232	10
REL-OR- 24AC/2X21	2834245	10
REL-OR-120AC/2X21	2834258	10
REL-OR-230AC/2X21	2834261	10

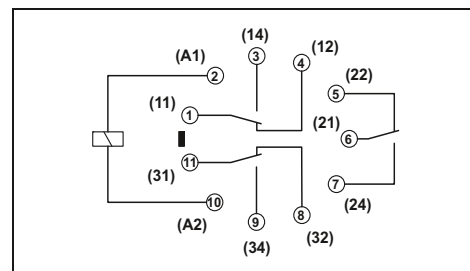

Technical data

Input data		①	②	③	④
Typ. input current at U_N	[mA]	56	110	22	10
Typ. response time at U_N	[ms]	12			
Typ. response time at U_N (AC, depending on phase relation)	[ms]		5 - 20	5 - 20	5 - 20
Typ. release time at U_N	[ms]	6			
Typ. release time at U_N (AC, depending on phase relation)	[ms]		5 - 20	5 - 20	5 - 20

Output data	
Contact type	Single contact, three PDTs
Contact material	AgSnIn
Max. switching voltage	250 V AC/DC
Min. switching voltage	1 V
Limiting continuous current	10 A (N/O contact)
Min. switching current	10 mA
Max. interrupting rating, ohmic load	2500 VA

General data	
Test voltage (winding / contact)	2.5 kV AC (50 Hz, 1 min.)
Test voltage (contact/contact)	2.5 kV AC (50 Hz, 1 min.)
Ambient temperature (operation)	-40°C ... 60°C
Nominal operating mode	100% operating factor
Mechanical service life	10 x 10 ⁶ cycles
Electrical service life	See diagram
Standards/regulations	IEC 60664
Mounting position/mounting	Any / On relay base PR3

Ordering data

Type	Order No.	Pcs. / Pkt.
REL-OR- 24DC/3X21	2834274	10
REL-OR- 24AC/3X21	2834287	10
REL-OR-120AC/3X21	2834290	10
REL-OR-230AC/3X21	2834300	10

REL-OR...2x21 (2 PDTs)

Interrupting rating

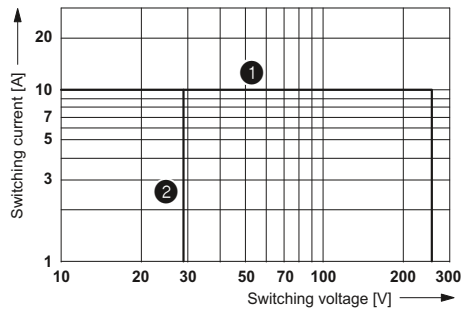

- 1 AC, ohmic load
- 2 DC, ohmic load

Electrical service life

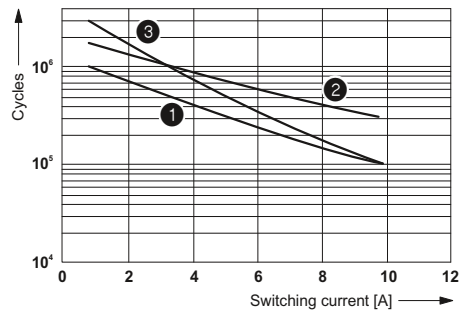

- 1 250V AC, ohmic load
- 2 120VDC, ohmic load
- 3 28V DC, ohmic load

Service life reduction factor with various cos phi

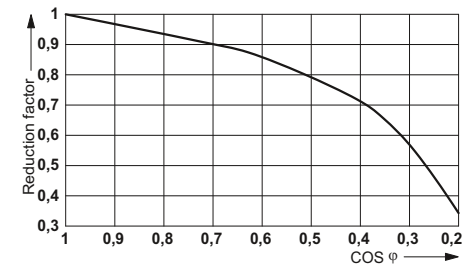

REL-OR...3x21 (3 PDTs)

Interrupting rating

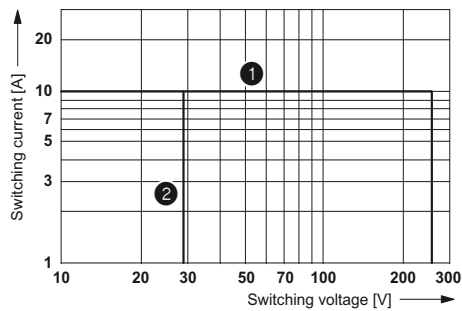

- 1 AC, ohmic load
- 2 DC, ohmic load

Electrical service life

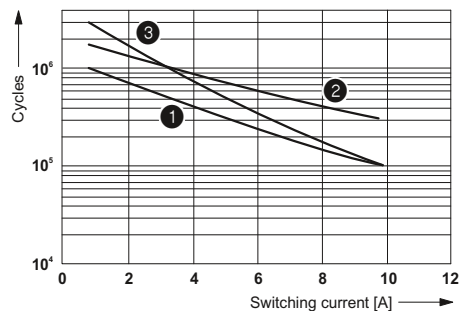

- 1 250V AC, ohmic load
- 2 120VDC, ohmic load
- 3 28V DC, ohmic load

Service life reduction factor with various cos phi

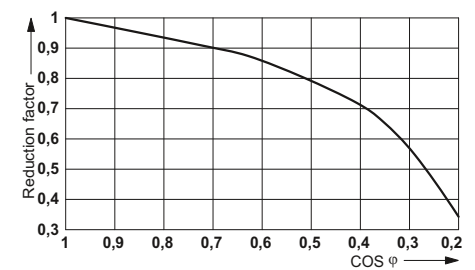

Relay modules

PR series

Plug-in octal relays for high DC loads

Plug-in octal relays with two N/O contacts connected in series suitable for PR3 and RIF-3 relay bases.

The relays are specially designed for switching high DC loads.

Further advantages:

- Full shutdown by means of 2 x 1.7 mm contact opening
- With lockable manual operation
- Integrated status LED
- Integrated freewheeling diode with DC types



1 N/O contact, with blow magnet



1 N/O contact

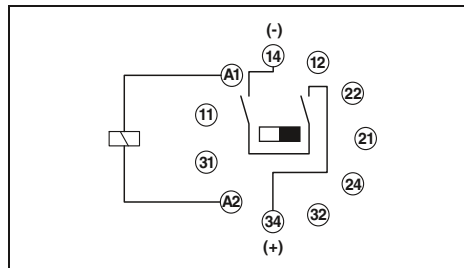

Technical data

①	②	③	④	⑤	⑥
refer to the diagram					
55	13	7	100	22	11
20	20	20	5 - 20	5 - 20	5 - 20
30	30	30	5 - 20	5 - 20	5 - 20

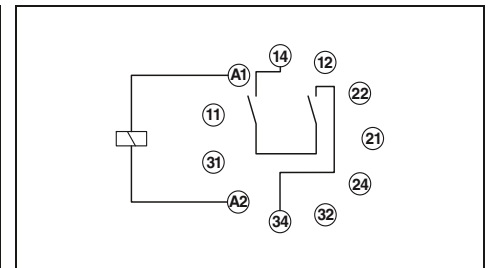

Technical data

①	②	③	④	⑤	⑥
refer to the diagram					
55	13	7	100	22	11
20	20	20	5 - 20	5 - 20	5 - 20
30	30	30	5 - 20	5 - 20	5 - 20

Input data	
Permissible range (with reference to U_N)	
Typ. input current at U_N	[mA]
Typ. response time at U_N	[ms]
Typ. response time at U_N (depending on phase relation)	[ms]
Typ. release time at U_N	[ms]
Typ. release time at U_N (depending on phase relation)	[ms]
Output data	
Contact type	
Contact material	
Max. switching voltage	
Min. switching voltage	
Limiting continuous current	
Min. switching current	
Max. interrupting rating, ohmic load	
	250 V AC
General data	
Test voltage (winding / contact)	
Ambient temperature (operation)	
Nominal operating mode	
Mechanical service life	
Standards/regulations	
Mounting position/mounting	

Single contact, 1 N/O contact (series connection, 2 N/O contacts) with blowout magnet					
AgNi					
250 V AC / 220 V DC					
10 V (at 10 mA)					
10 A					
10 mA (at 10 V)					
2500 VA					
2.5 kV _{rms} (50 Hz, 1 min.)					
-40°C ... 60°C					
100% operating factor					
Approx. 10 ⁷ cycles					
IEC 61810, EN 60947					
Any / On relay base PR3					

Single contact, 1 N/O contact (series connection, 2 N/O contacts)					
AgNi					
250 V AC / 220 V DC					
10 V (at 10 mA)					
10 A					
10 mA (at 10 V)					
2500 VA					
2.5 kV _{rms} (50 Hz, 1 min.)					
-40°C ... 60°C					
100% operating factor					
Approx. 10 ⁷ cycles					
IEC 61810, EN 60947					
Any / On relay base PR3					

Ordering data

Description	Input voltage U_N	Type	Order No.	Pcs. / Pkt.
Plug-in octal relay for high DC loads	① 24 V DC	REL-OR/LDP- 24DC/1/MB	2901901	10
	② 110 V DC	REL-OR/LDP-110DC/1/MB	2901902	10
	③ 220 V DC	REL-OR/LDP-220DC/1/MB	2901904	10
	④ 24 V AC	REL-OR/L- 24AC/1/MB	2901905	10
	⑤ 120 V AC	REL-OR/L-120AC/1/MB	2901906	10
	⑥ 230 V AC	REL-OR/L-230AC/1/MB	2901907	10

Ordering data

Type	Order No.	Pcs. / Pkt.
REL-OR/LDP- 24DC/1	2901908	10
REL-OR/LDP-110DC/1	2901909	10
REL-OR/LDP-220DC/1	2901910	10
REL-OR/L- 24AC/1	2901911	10
REL-OR/L-120AC/1	2901912	10
REL-OR/L-230AC/1	2901913	10

REL-OR.../1/MB (1 N/O contact with blow magnet)

Operating voltage range of the relay

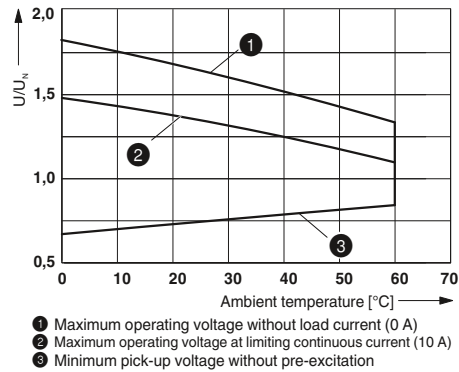

DC interrupting rating

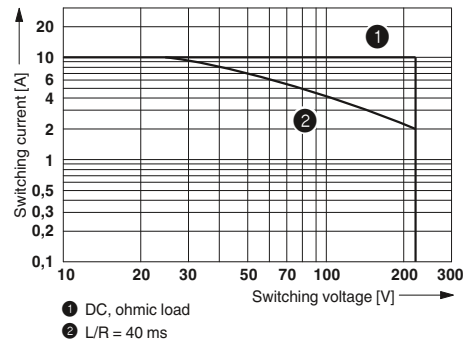

REL-OR.../1 (1 N/O contact)

Operating voltage range of the relay

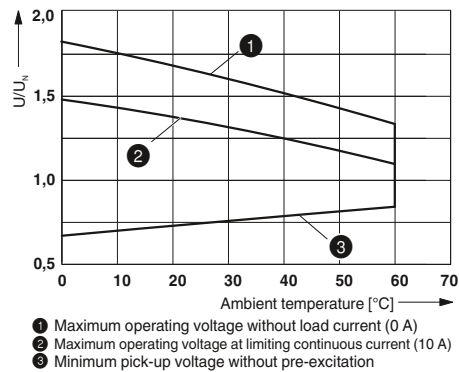

DC interrupting rating

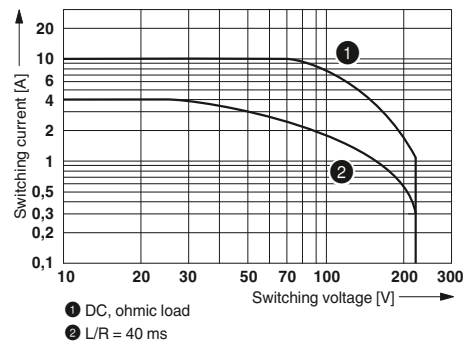

Relay modules

PR series

Input modules/interference suppression modules for PR1, PR2, and PR3

Plug-in input modules/interference suppression modules for optional fitting of PR... relay base

The advantages:

- Attenuation of reverse voltage induced in coil
- Mechanical coding to protect against incorrect connection



Input/interference suppression module to match PR1 and PR2



Input/interference suppression module to match PR3



Description	Ordering data			Ordering data		
	Type	Order No.	Pcs. / Pkt.	Type	Order No.	Pcs. / Pkt.
Plug-in module , for mounting on PR..., with LED status indicator and freewheeling diode to limit the coil induction voltage effectively, polarity: A1 +, A2 - , Input voltage: - 12-24 V DC $\pm 20\%$ - 48-60 V DC $\pm 20\%$ - 110 V DC $\pm 20\%$	LDP- 12- 24DC	2833657	10	LDP3- 12- 24DC	2833770	10
	LDP- 48- 60DC	2833660	10	LDP3- 48- 60DC	2833783	10
	LDP-110DC	2833673	10	LDP3-110DC	2833796	10
Plug-in module , for mounting on PR..., with LED status indicator and freewheeling diode to limit the coil induction voltage effectively, polarity: A1 -, A2 + (Japanese standard), Input voltage: - 12-24 V DC $\pm 20\%$ - 48-60 V DC $\pm 20\%$ - 110 V DC $\pm 20\%$	LDM- 12- 24DC	2833686	10	LDM3- 12- 24DC	2833806	10
	LDM- 48- 60DC	2833699	10	LDM3- 48- 60DC	2833819	10
	LDM-110DC	2833709	10	LDM3-110DC	2833822	10
Plug-in module , for mounting on PR..., with LED status indicator and varistor to limit the coil induction voltage and/or external interference peaks, Input voltage: - 12-24 V AC/DC $\pm 20\%$ (30-V-varistor) - 48-60 V AC/DC $\pm 20\%$ (75-V-varistor) - 120-230 V AC/110 V DC $\pm 20\%$ (275-V-varistor)	LV- 12- 24UC	2833712	10	LV3- 12- 24UC	2833835	10
	LV- 48- 60UC	2833725	10	LV3- 48- 60UC	2833848	10
	LV-120-230AC/110DC	2833738	10	LV3-120-230AC/110DC	2833851	10
Plug-in module , for mounting on PR..., with varistor to limit the coil induction voltage and/or external interference peaks, Input voltage: - 12-24 V AC/DC $\pm 20\%$ (30-V-varistor) - 48-60 V AC/DC $\pm 20\%$ (75-V-varistor) - 120-230 V AC/DC $\pm 20\%$ (275-V-varistor)	V- 12- 24UC	2833864	10	V3- 12- 24UC	2833929	10
	V- 48- 60UC	2833877	10	V3- 48- 60UC	2833932	10
	V-120-230UC	2833880	10	V3-120-230UC	2833945	10
Plug-in module , for mounting on PR..., with RD-element to attenuate the coil induction voltage and/or external interference peaks, Input voltage: - 12-24 V AC/DC $\pm 20\%$ (220 nF/100 Ω) - 48-60 V AC/DC $\pm 20\%$ (220 nF/220 Ω) - 120-230 V AC/DC $\pm 20\%$ (100 nF/470 Ω)	RC- 12- 24UC	2833741	10	RC3- 12- 24UC	2833893	10
	RC- 12- 24UC	2833754	10	RC3- 48- 60UC	2833903	10
	RC-120-230UC	2833767	10	RC3-120-230UC	2833916	10

Terminal assignment PR1 base / Solid-state relay								
	Terminal blocks, PR1 base							
	A1	A2	11	12	14	21	22	24
Solid-state relays								
SIM-EI...48DC/100	A2 (-)	A1 (+)			A	+		
SIM-EI...TTL/100	A2 (-)	A1 (+)			A	+	0	
SIM-EI...48DC/100RC	A2 (-)	A1 (+)			A	+		
SIM-EI-OV-24DC/24DC/3	A2 (-)	A1 (+)			A	+		
OPT-...24DC/5	A1 (+)	A2 (-)	13		14			
OPT-...230AC/2	A1 (+)	A2 (-)	13		14			

The relay bases of the PR1 series can also be equipped with wear-free solid-state relays (OPT... or SIM-EI...) as an alternative to the electromechanical relay.

LDP... and LV... plug-in modules cannot be used in conjunction with SIM-EI... solid-state relays

Relay modules

PR series

Fully mounted PR1 relay modules with screw connection

Fully mounted PR1 relay modules, consisting of:

- Relay base
- 1/2 PDT relay
- Relay retaining bracket
- Input module/interference suppr. module
- Marking labels

The advantages:

- Logical contact arrangement thanks to 1/3-level relay base
- Operational reliability thanks to sealed relay
- Safe isolation between coil and contact side

Notes:	
Type of housing:	Polyamide fiber reinforced PA-F, color: green.
For the protection of input and output, inductive loads must be dampened with an effective protection circuit.	
If the specified maximum values for multi-layer contact relays are exceeded, the gold plating is destroyed. The maximum values of the power contact relay are then valid. This can result in a shorter service life than with a pure power contact.	
Other input voltages on request.	
1) EMC: Class A product, see page 571	

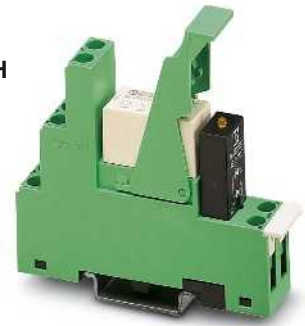

PR1 relay module with 1 PDT relay

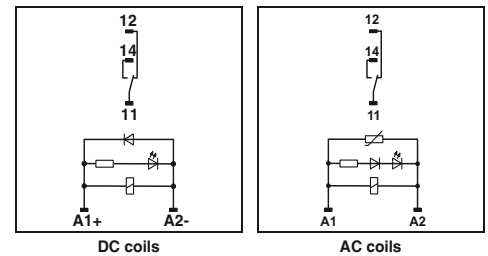

Input data	
Permissible range (with reference to U_N)	
Typ. input current with U_N (for AC: 50/60 Hz)	[mA]
Typ. response time at U_N	[ms]
Typ. release time at U_N	[ms]
Input protection:	24 V DC 24, 120, 230 V AC
Output data	
Contact type	
Contact material	
Maximum switching voltage	
Minimum switching voltage	
Limiting continuous current	
Maximum inrush current	
Min. switching current	
Interrupting rating (ohmic load) max.	
General data	
Test voltage	Winding to contact Contact/contact
Ambient temperature (operation)	
Nominal operating mode	
Mechanical service life	
Service life, electrical	
Standards/regulations	
Pollution degree/surge voltage category	
Mounting position / Mounting	
Connection data solid / stranded / AWG	
Dimensions	W / H / D

Technical data			
24 V DC	24 V AC	120 V AC	230 V AC
See diagram			
19	34 / 26	9 / 7	6 / 5.5
8	3 ... 12	3 ... 12	3 ... 12
10	1.5 ... 14	1.5 ... 16	2 ... 22
Damping diode, Yellow LED Varistor, Yellow LED			
PR...		PR...AU	
Single contact, 1-PDT		Single contact, 1-PDT	
AgNi		AgNi, hard gold-plated	
250 V AC/DC		30 V AC / 36 V DC	
12 V (at 10 mA)		100 mV (at 10 mA)	
12 A		50 mA	
30 A (300 ms)		50 mA	
100 mA		1 mA (at 24 V)	
3000 VA (for 250 V AC)		-	
For more data, see diagram			

Description	Input voltage U_N
Pre-assembled coupling relay modules with miniature power contact relay	24 V DC
	24 V AC
	120 V AC
	230 V AC
Pre-assembled coupling relay modules with multi-layer contact relay	24 V DC
	24 V AC
	120 V AC
	230 V AC

Ordering data		
Type	Order No.	Pcs. / Pkt.
PR1-RSC3-LDP-24DC/21 ¹)	2834326	5
PR1-RSC3-LV- 24AC/21 ¹)	2834339	5
PR1-RSC3-LV-120AC/21 ¹)	2834342	5
PR1-RSC3-LV-230AC/21 ¹)	2834355	5
PR1-RSC3-LDP-24DC/21AU ¹)	2834368	5
PR1-RSC3-LV- 24AC/21AU ¹)	2834371	5
PR1-RSC3-LV-120AC/21AU ¹)	2834384	5
PR1-RSC3-LV-230AC/21AU ¹)	2834397	5

Device marking label, for thermal transfer printer, labeling surface 6 x 15 mm

Accessories		
EML (15X6) R YE	0819288	1

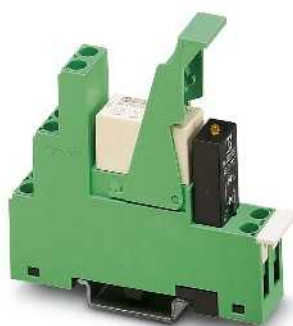

PR1 relay module with 2 PDT contact relay

PR1-RSC3.../21 (1 PDT)

Operating voltage range of the relay

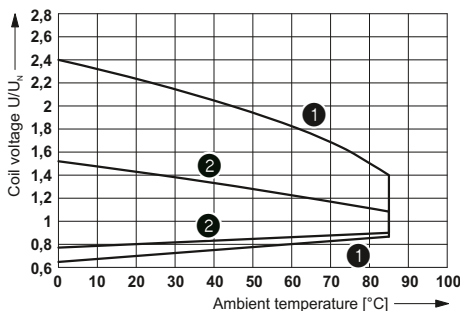

- 1 DC coils
- 2 AC coils

Interrupting rating

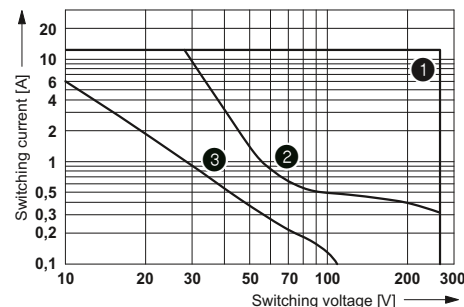

- 1 AC, ohmic load
- 2 DC, ohmic load
- 3 DC, L/R = 40 ms

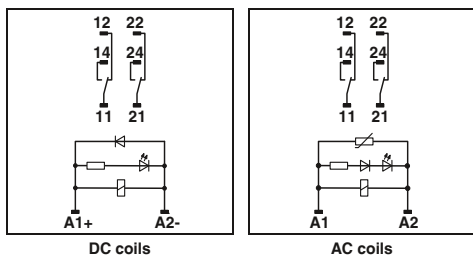

DC coils

AC coils

Service life reduction factor

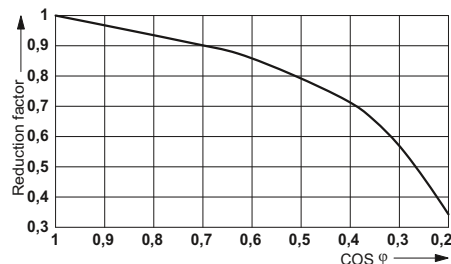

Electrical service life

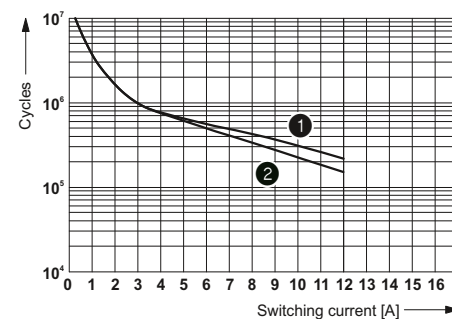

- 1 250 V AC, ohmic load (DC coils)
- 2 250 V AC, ohmic load (AC coils)

Technical data

24 V DC	24 V AC	120 V AC	230 V AC
See diagram			
19	34 / 26	9 / 7	6 / 5.5
8	3 ... 12	3 ... 12	3 ... 12
10	1.5 ... 14	1.5 ... 16	2 ... 22

Damping diode, Yellow LED
Varistor, Yellow LED

PR...	PR...AU
Single contact, 2-PDT	Single contact, 2-PDT

AgNi	AgNi, hard gold-plated
250 V AC/DC	30 V AC / 36 V DC
5 V (at 10 mA)	100 mV (at 10 mA)
8 A	50 mA
15 A (300 ms)	50 mA
10 mA (At 5 V)	1 mA (at 24 V)
2000 VA (for 250 V AC)	-
For more data, see diagram	

4 kV (50 Hz, 1 min.)
2.5 kV (50 Hz, 1 min.)
-25°C ... 60°C
100% operating factor
3 x 10⁷ cycles
See diagram
IEC 60664, EN 50178, IEC 62103
3 / III
Any / In rows with zero spacing
0.14 - 2.5 mm² / 0.14 - 2.5 mm² / 26 - 14
16 mm / 78.5 mm / 71 mm

PR1-RSC3.../2x21 (2 PDT)

Operating voltage range of the relay

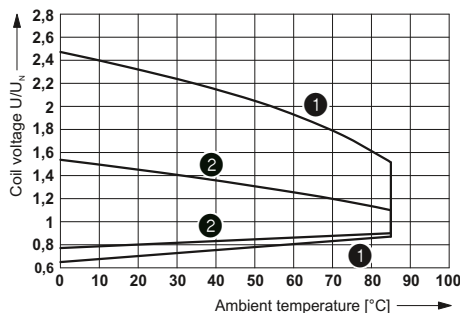

- 1 DC coils
- 2 AC coils

Interrupting rating

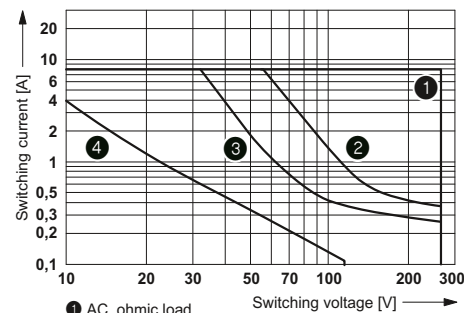

- 1 AC, ohmic load
- 2 DC, ohmic load, contacts in series
- 3 DC, ohmic load
- 4 DC, L/R = 40 ms

Service life reduction factor with various cos phi

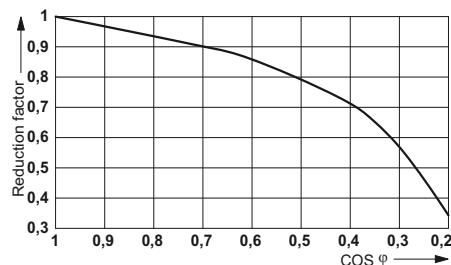

Electrical service life

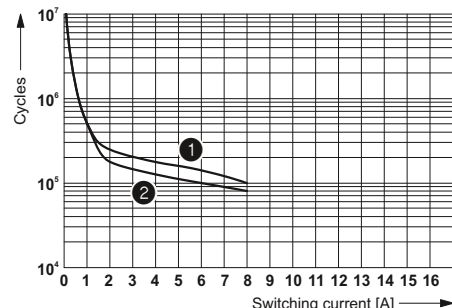

- 1 250 V AC, ohmic load (DC coils)
- 2 250 V AC, ohmic load (AC coils)

Ordering data

Type	Order No.	Pcs. / Pkt.
PR1-RSC3-LDP-24DC/2X21 ¹⁾	2834481	5
PR1-RSC3-LV- 24AC/2X21 ¹⁾	2834494	5
PR1-RSC3-LV-120AC/2X21 ¹⁾	2834504	5
PR1-RSC3-LV-230AC/2X21 ¹⁾	2834517	5
PR1-RSC3-LDP-24DC/2X21AU ¹⁾	2834520	5
PR1-RSC3-LV- 24AC/2X21AU ¹⁾	2834533	5
PR1-RSC3-LV-120AC/2X21AU ¹⁾	2834546	5
PR1-RSC3-LV-230AC/2X21AU ¹⁾	2834559	5

Accessories

EML (15X6) R YE	0819288	1
-----------------	---------	---

Relay modules

PR series

Fully mounted PR1 relay modules with spring-cage connection

Fully mounted PR1 relay modules, consisting of:

- Relay base
- 1/2 PDT relay
- Relay retaining bracket
- Input module/interference suppr. module
- Marking labels

The advantages:

- Logical contact arrangement thanks to 1/3-level relay base
- Operational reliability thanks to sealed relay
- Safe isolation between coil and contact side

Notes:
Type of housing: Polyamide fiber reinforced PA-F, color: green.
For the protection of input and output, inductive loads must be dampened with an effective protection circuit.
If the specified maximum values for multi-layer contact relays are exceeded, the gold plating is destroyed. The maximum values of the power contact relay are then valid. This can result in a shorter service life than with a pure power contact.
There is a double spring-cage for each terminal point.
Other input voltages on request.
1) EMC: Class A product, see page 571

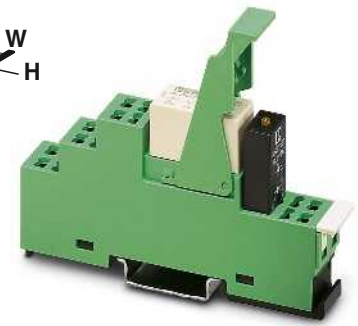

PR1 relay module with 1 PDT relay

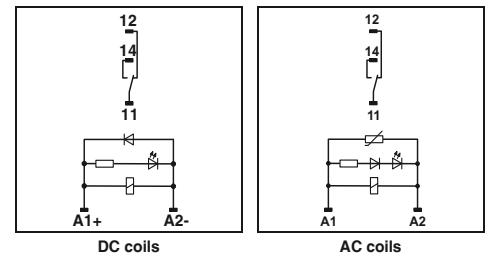

Input data	
Permissible range (with reference to U_N)	
Typ. input current with U_N (for AC: 50/60 Hz)	[mA]
Typ. response time at U_N	[ms]
Typ. release time at U_N	[ms]
Input protection:	24 V DC 24, 120, 230 V AC
Output data	
Contact type	
Contact material	
Maximum switching voltage	
Minimum switching voltage	
Limiting continuous current	
Maximum inrush current	
Min. switching current	
Interrupting rating (ohmic load) max.	
General data	
Test voltage	Winding to contact Contact/contact
Ambient temperature (operation)	
Nominal operating mode	
Mechanical service life	
Service life, electrical	
Standards/regulations	
Pollution degree/surge voltage category	
Mounting position / Mounting	
Connection data solid / stranded / AWG	
Dimensions	W / H / D

Technical data			
24 V DC	24 V AC	120 V AC	230 V AC
See diagram			
19	34 / 26	9 / 7	6 / 5.5
8	3 ... 12	3 ... 12	3 ... 12
10	1.5 ... 14	1.5 ... 16	2 ... 22
Damping diode, Yellow LED Varistor, Yellow LED			
PR...AU		PR...AU	
Single contact, 1-PDT		Single contact, 1-PDT	
AgNi		AgNi, hard gold-plated	
250 V AC/DC		30 V AC / 36 V DC	
12 V (at 10 mA)		100 mV (at 10 mA)	
10 A		50 mA	
30 A (300 ms)		50 mA	
100 mA		1 mA (at 24 V)	
2500 VA		-	
For more data, see diagram			

Description	Input voltage U_N
Pre-assembled coupling relay modules with miniature power contact relay	24 V DC
	24 V AC
	120 V AC
	230 V AC
Pre-assembled coupling relay modules with multi-layer contact relay	24 V DC
	24 V AC
	120 V AC
	230 V AC

Ordering data		
Type	Order No.	Pcs. / Pkt.
PR1-RSP3-LDP-24DC/21 ¹)	2834407	5
PR1-RSP3-LV- 24AC/21 ¹)	2834410	5
PR1-RSP3-LV-120AC/21 ¹)	2834423	5
PR1-RSP3-LV-230AC/21 ¹)	2834436	5
PR1-RSP3-LDP-24DC/21AU ¹)	2834449	5
PR1-RSP3-LV- 24AC/21AU ¹)	2834452	5
PR1-RSP3-LV-120AC/21AU ¹)	2834465	5
PR1-RSP3-LV-230AC/21AU ¹)	2834478	5

Device marking label, for thermal transfer printer, labeling surface 6 x 15 mm

Accessories		
EML (15X6) R YE	0819288	1

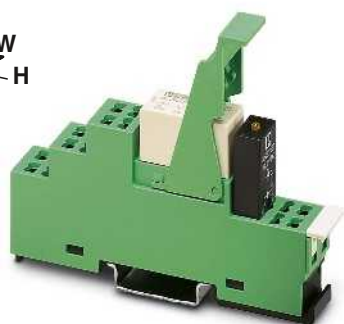

PR1 relay module with 2 PDT contact relay

PR1-RSP3.../21 (1 PDT)

Operating voltage range of the relay

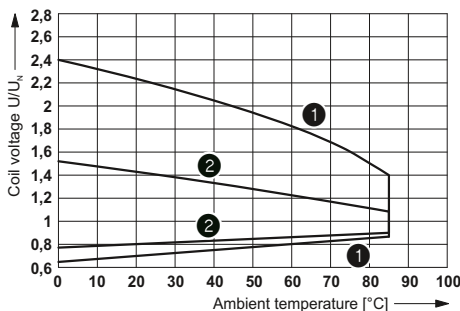

- 1 DC coils
- 2 AC coils

Electrical service life

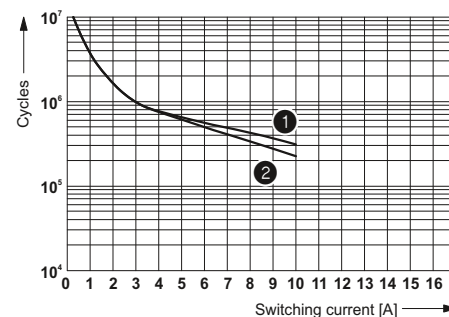

- 1 250 V AC, ohmic load (DC coils)
- 2 250 V AC, ohmic load (AC coils)

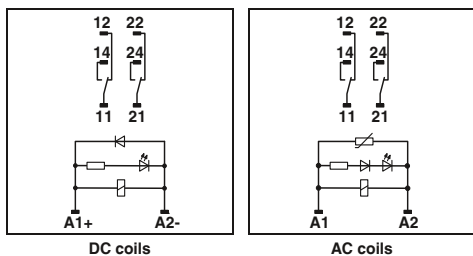

Interrupting rating

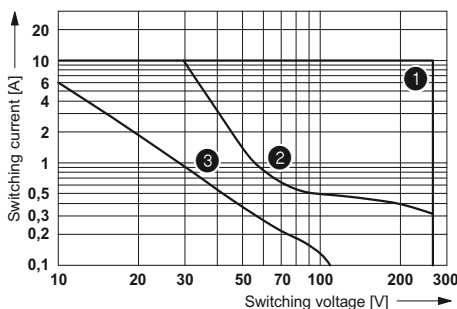

- 1 AC, ohmic load
- 2 DC, ohmic load
- 3 DC, L/R = 40 ms

Service life reduction factor with various cos phi

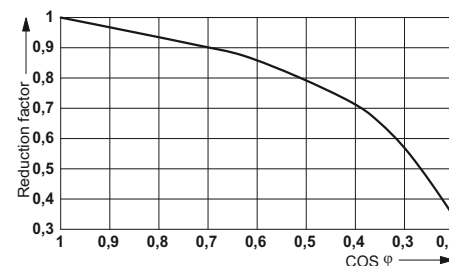

Technical data

24 V DC	24 V AC	120 V AC	230 V AC
See diagram			
19	34 / 26	9 / 7	6 / 5.5
8	3 ... 12	3 ... 12	3 ... 12
10	1.5 ... 14	1.5 ... 16	2 ... 22
Damping diode, Yellow LED			
Varistor, Yellow LED			
PR...	PR...AU		
Single contact, 2-PDT	Single contact, 2-PDT		

AgNi
250 V AC/DC
5 V (at 10 mA)
8 A
15 A (300 ms)
10 mA (At 5 V)
2000 VA
For more data, see diagram

4 kV (50 Hz, 1 min.)
2.5 kV (50 Hz, 1 min.)
-25°C ... 60°C
100% operating factor
3 x 10⁷ cycles
See diagram
IEC 60664, EN 50178, IEC 62103
3 / III
Any / In rows with zero spacing
0.2 - 1.5 mm² / 0.2 - 1.5 mm² / 24 - 16
16 mm / 97 mm / 72 mm

PR1-RSP3.../2x21 (2 PDT)

Operating voltage range of the relay

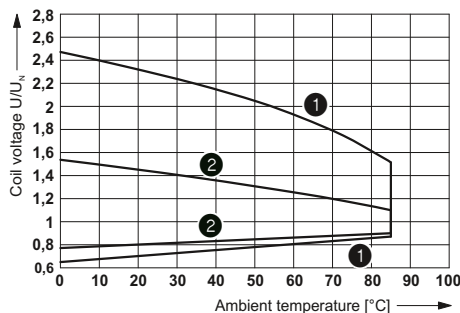

- 1 DC coils
- 2 AC coils

Interrupting rating

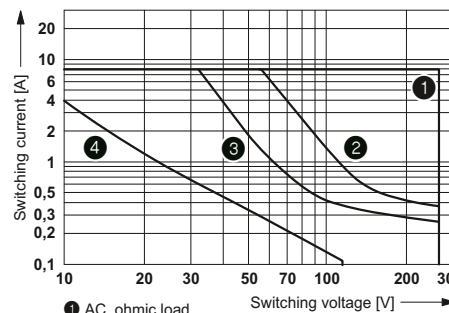

- 1 AC, ohmic load
- 2 DC, ohmic load, contacts in series
- 3 DC, ohmic load
- 4 DC, L/R = 40 ms

Service life reduction factor with various cos phi

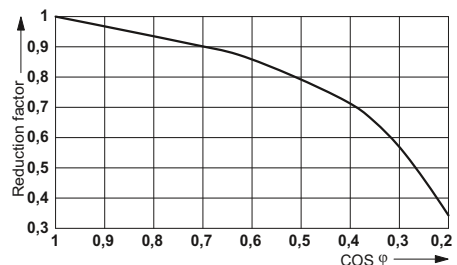

Electrical service life

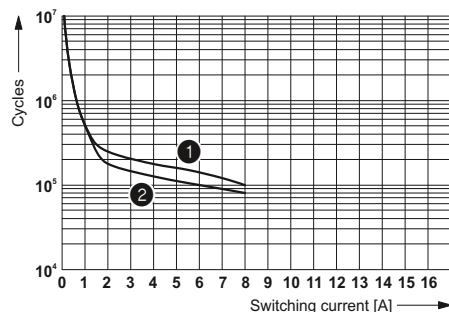

- 1 250 V AC, ohmic load (DC coils)
- 2 250 V AC, ohmic load (AC coils)

Ordering data

Type	Order No.	Pcs. / Pkt.
PR1-RSP3-LDP-24DC/2X21 ¹⁾	2834562	5
PR1-RSP3-LV- 24AC/2X21 ¹⁾	2834575	5
PR1-RSP3-LV-120AC/2X21 ¹⁾	2834588	5
PR1-RSP3-LV-230AC/2X21 ¹⁾	2834591	5
PR1-RSP3-LDP-24DC/2X21AU ¹⁾	2834601	5
PR1-RSP3-LV- 24AC/2X21AU ¹⁾	2834614	5
PR1-RSP3-LV-120AC/2X21AU ¹⁾	2834627	5
PR1-RSP3-LV-230AC/2X21AU ¹⁾	2834630	5

Accessories

EML (15X6) R YE	0819288	1
-----------------	---------	---

Relay modules

PR series

Fully mounted PR2 relay modules

Fully mounted PR2 relay modules, consisting of:

- Relay base
 - 2/4 PDT relay
 - Relay retaining bracket
 - Input module/interference suppr. module (AC types only)
 - Marking labels
- The advantages:
- Relay with lockable manual operation and status LED
 - With DC types, freewheeling diode is integrated into relay
 - Mechanical switch position indicator
 - Logical contact arrangement thanks to 1/3-level relay base
 - Screw or spring-cage connection
 - 4 PDT types with multi-layer gold contacts

Notes:
Type of housing: Polyamide fiber reinforced PA-F, color: green.
For the protection of input and output, inductive loads must be dampened with an effective protection circuit.
If the specified maximum values for multi-layer contact relays are exceeded, the gold plating is destroyed. The maximum values of the power contact relay are then valid. This can result in a shorter service life than with a pure power contact.
Other input voltages on request.
The DC types do not have a plug-in module because the status LED and the freewheeling diode are integrated directly into the relay.
1) EMC: Class A product, see page 571

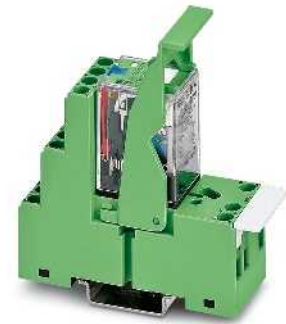

PR2 relay module with screw connection

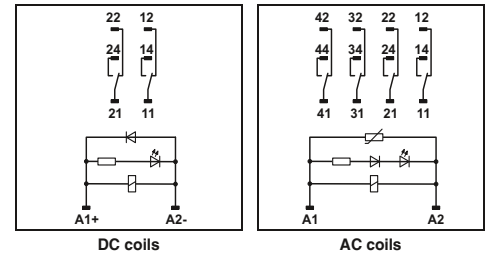

Input data	
Permissible range (with reference to U_N)	
Typ. input current with U_N (for AC: 50/60 Hz)	[mA]
Typ. response time at U_N	[ms]
Typ. release time at U_N	[ms]
Input protection:	24 V DC 24, 120, 230 V AC
Output data	
Contact type	
Contact material	
Maximum switching voltage	
Minimum switching voltage	
Limiting continuous current	
Maximum inrush current	
Min. switching current	
Interrupting rating (ohmic load) max.	
General data	
Test voltage	Winding to contact Contact/contact
Ambient temperature (operation)	
Nominal operating mode	
Mechanical service life	
Service life, electrical	
Standards/regulations	
Pollution degree/surge voltage category	
Mounting position / Mounting	
Connection data solid / stranded / AWG	
Dimensions	W / H / D

Technical data			
24 V DC	24 V AC	120 V AC	230 V AC
See diagram			
38	54 / 46	11 / 9	5 / 4
13	4 ... 10	4 ... 10	4 ... 10
5	3 ... 12	3 ... 12	3 ... 12
Damping diode, Green LED Varistor, LED red			
PR...		PR...AU	
Single contact, 2-PDT		Single contact, 4-PDT	
Ag		AgNi, hard gold-plated	
250 V AC / 125 V DC		250 V AC / 125 V DC	
5 V		1 V	
10 A		5 A	
20 A (15 ms)		12 A (15 ms)	
1 mA		1 mA	
2500 VA		1250 VA	
For more data, see diagram			

Description	Input voltage U_N
Pre-assembled coupling relay modules with 2-PDT contact relay	24 V DC
	24 V AC
	120 V AC
	230 V AC
Pre-assembled coupling relay modules with 4-PDT contact relay and additional hard gold-plating	24 V DC
	24 V AC
	120 V AC
	230 V AC

Ordering data		
Type	Order No.	Pcs. / Pkt.
PR2-RSC3-LDP-24DC/2X21 ¹⁾	2834643	5
PR2-RSC3-LV- 24AC/2X21 ¹⁾	2834656	5
PR2-RSC3-LV-120AC/2X21 ¹⁾	2834669	5
PR2-RSC3-LV-230AC/2X21 ¹⁾	2834672	5
PR2-RSC3-LDP-24DC/4X21AU ¹⁾	2834724	5
PR2-RSC3-LV- 24AC/4X21AU ¹⁾	2834737	5
PR2-RSC3-LV-120AC/4X21AU ¹⁾	2834740	5
PR2-RSC3-LV-230AC/4X21AU ¹⁾	2834753	5

Device marking label, for thermal transfer printer, labeling surface 6 x 15 mm

Accessories		
EML (15X6) R YE	0819288	1

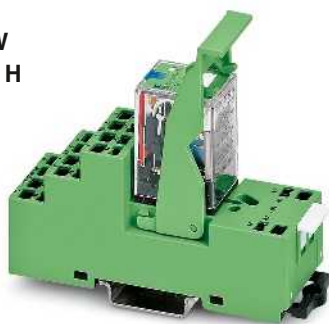

PR2 relay module with spring-cage connection

PR2-RS.../2x21 (2 PDT)

Operating voltage range of relay $T_u=T_{coil}$

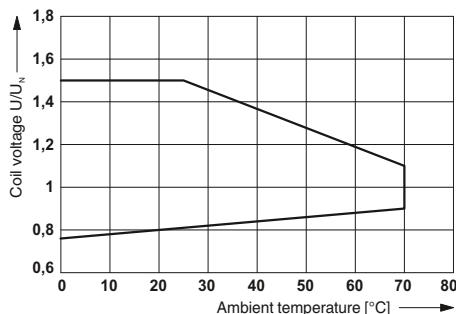

AC interrupting rating

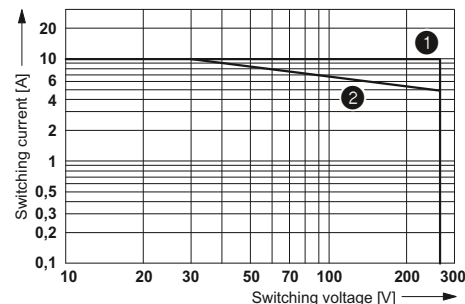

- 1 Ohmic load
- 2 $\cos \varphi = 0.4$

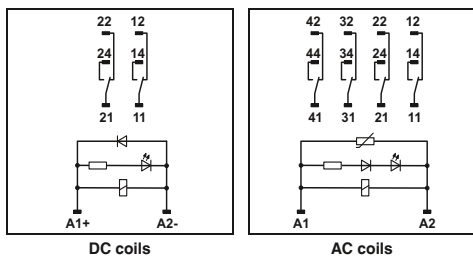

DC interrupting rating

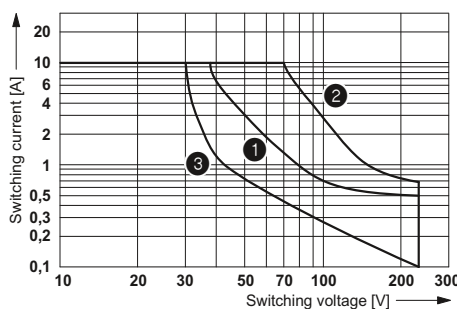

- 1 Ohmic load
- 2 ohmic load, contacts in series
- 3 $L/R < 7$ ms

Electrical service life

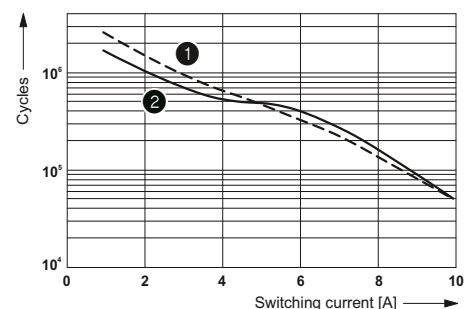

- 1 250 V AC, ohmic load
- 2 30 V DC, ohmic load

Technical data

24 V DC	24 V AC	120 V AC	230 V AC
See diagram			
38	54 / 46	11 / 9	5 / 4
13	4 ... 10	4 ... 10	4 ... 10
5	3 ... 12	3 ... 12	3 ... 12

Damping diode, Green LED
Varistor, LED red

PR... AU
Single contact, 2-PDT Single contact, 4-PDT

Ag
250 V AC / 125 V DC
5 V
10 A
20 A (15 ms)
1 mA
2500 VA
For more data, see diagram

AgNi, hard gold-plated
250 V AC / 125 V DC
1 V
5 A
12 A (15 ms)
1 mA
1250 VA

2 kV (50 Hz, 1 min.)
2 kV (50 Hz, 1 min.)
-25°C ... 60°C
100% operating factor
5 x 10^7 cycles
See diagram
IEC 60664, EN 50178, IEC 62103
3 / II
Any / In rows with zero spacing
0.2 - 1.5 mm² / 0.2 - 1.5 mm² / 24 - 16
31 mm / 95 mm / 84 mm

Ordering data

Type	Order No.	Pcs. / Pkt.
PR2-RSP3-LDP-24DC/2X21 ¹⁾	2834685	5
PR2-RSP3-LV- 24AC/2X21 ¹⁾	2834698	5
PR2-RSP3-LV-120AC/2X21 ¹⁾	2834708	5
PR2-RSP3-LV-230AC/2X21 ¹⁾	2834711	5
PR2-RSP3-LDP-24DC/4X21AU ¹⁾	2834766	5
PR2-RSP3-LV- 24AC/4X21AU ¹⁾	2834779	5
PR2-RSP3-LV-120AC/4X21AU ¹⁾	2834782	5
PR2-RSP3-LV-230AC/4X21AU ¹⁾	2834795	5

Accessories

EML (15X6) R YE	0819288	1
-----------------	---------	---

PR2-RS.../4x21 (4 PDT)

Operating voltage range of relay $T_u=T_{coil}$

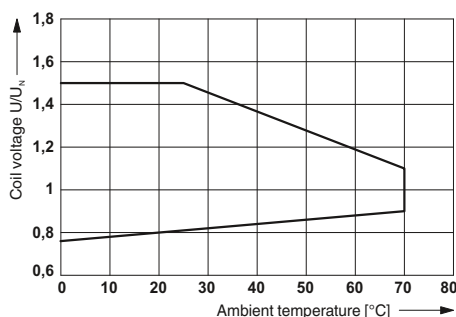

AC interrupting rating

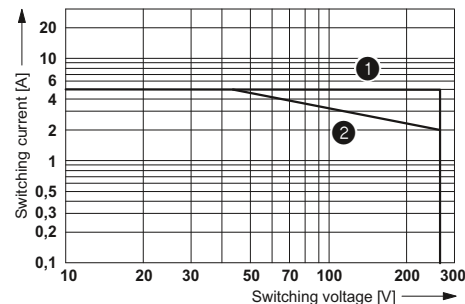

- 1 Ohmic load
- 2 $\cos \varphi = 0.4$

DC interrupting rating

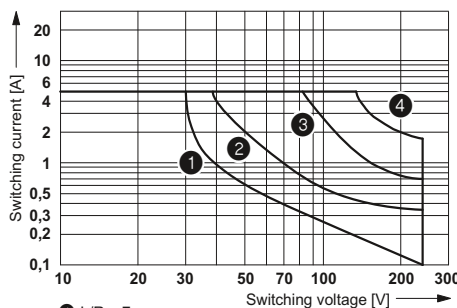

- 1 $L/R < 7$ ms
- 2 ohmic load
- 3 ohmic load, 2 contacts in series
- 4 ohmic load, 4 contacts in series

Electrical service life

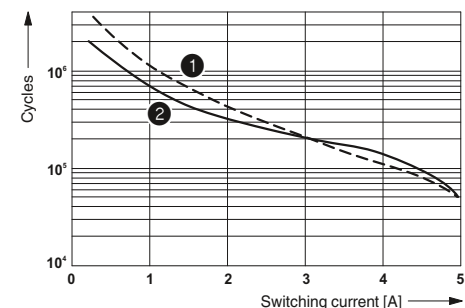

- 1 250 V AC, ohmic load
- 2 30 V DC, ohmic load

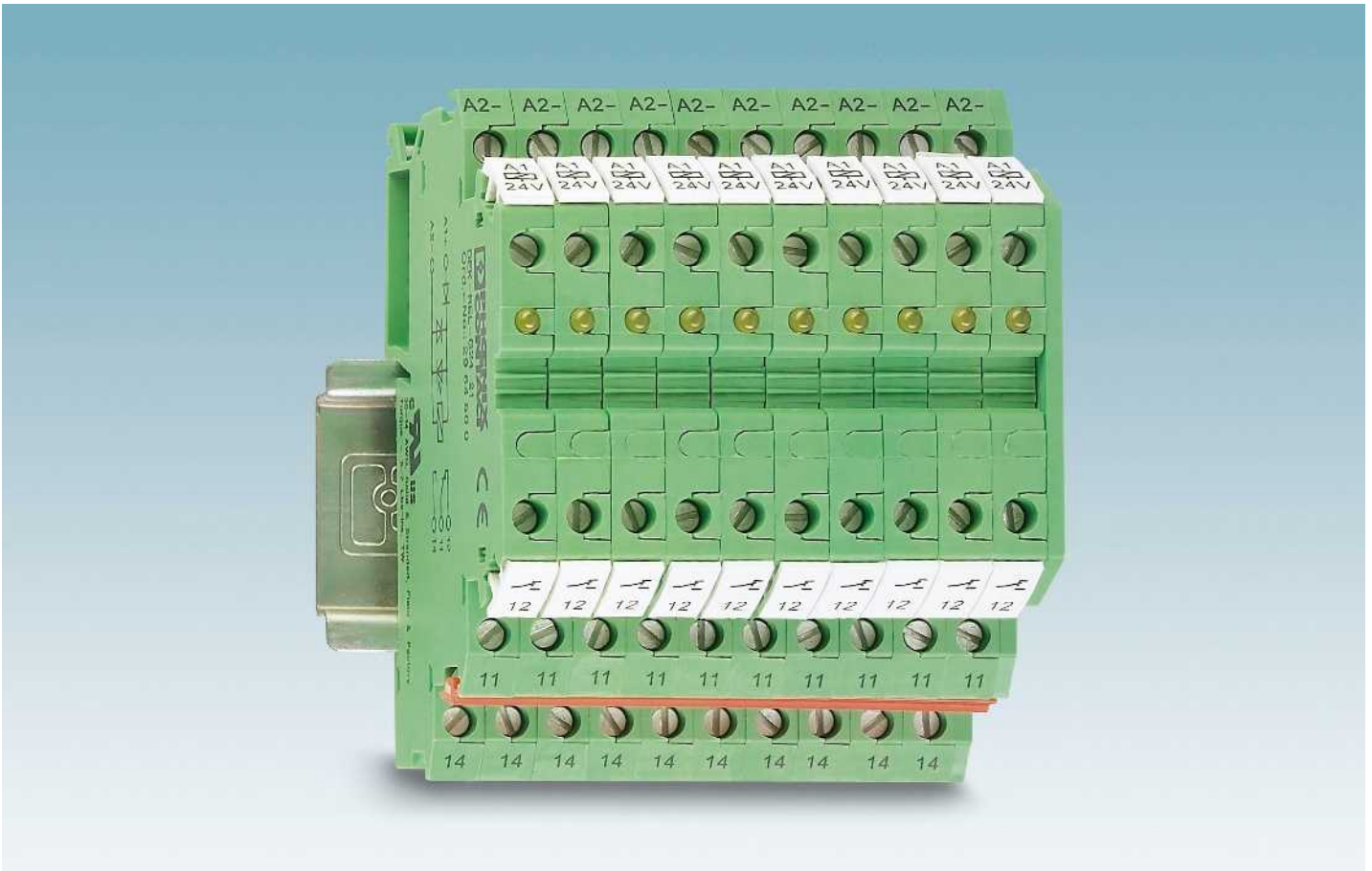

The Phoenix Contact DEK interface terminal blocks provide complete interface functions in modular terminal block housing that is just 6.2 mm wide. In conjunction with standard terminal block accessories, these high-capacity interfaces have not only the design but also the high level of user convenience of modular terminal blocks.

The main common feature of all Phoenix Contact interface terminal blocks is their width of just 6.2 mm. This saves 60% space in the control cabinet in comparison to conventional 15 mm wide coupling relays from modular systems.

The DEK range offers the best solution for all industrial voltages both for signal input and output.

High switching capacities are a matter of course for the DEK-REL... relay terminal block and the DEK-OV... solid-state relay terminal block.

The wear-free DEK-OV... power solid-state relay terminal block is used for applications that require a greater switching frequency in which electromechanical relays reach the end of their service life in a short time.

Integrated LEDs clearly indicate the switching status of the electronic terminal blocks and provide an excellent overview of the coupling level and the system.

Colored EB-DIK insertion bridges for the supply and ground signals make it possible to design the circuit simply and effectively.

Integrated protective circuits such as free-wheeling diodes, polarity reversal protection diodes, and surge protection elements protect the coupling modules and ensure optimum availability of the system.

DEK-REL-... relay terminal block

The Phoenix Contact relay terminal block with PDT contact offers the following advantages:

- Width of only 6.2 mm
- High switching capacity of 250 V AC/6 A
- Less storage, since PDT, N/O or N/C contacts can be wired
- Little wiring expense due to the use of EB-DIK insertion bridges
- IP67 protected relay housing
- Cadmium-free relay contacts
- 4 kV electrical isolation of input and output
- Safe isolation according to DIN EN 50178 (VDE 0160)
- Light indicator for signaling the switching status.

Notes:
Type of housing: Polyamide PA non-reinforced, color: green.
Marking systems and mounting material See Catalog 5
For the protection of relay coils and contacts, inductive loads must be dampened with an efficient protection circuit.
For further EB...DIK... insertion bridges, refer to page 403
1) EMC: Class A product, see page 571



**For medium to large power
1 PDT (21)**



Technical data

Input data	①
Permissible range (with reference to U_N)	0.8 - 1.1
Typ. input current at U_N [mA]	9
Response/release time at U_N [ms]	8 / 5
Input protection:	Yellow LED, Protection against polarity reversal, freewheeling diode
Output data	
Contact type	Single contact, 1-PDT
Contact material	AgSnO
Max. switching voltage	250 V AC/DC
Min. switching voltage	12 V AC/DC
Limiting continuous current	6 A
Max. inrush current	6 A
Min. switching current	10 mA
Max. interrupting rating, ohmic load	
	24 V DC 140 W
	48 V DC 20 W
	60 V DC 18 W
	110 V DC 23 W
	220 V DC 40 W
	250 V AC 1500 VA
General data	
Test voltage (winding / contact)	4 kV AC (50 Hz, 1 min.)
Ambient temperature (operation)	-20°C ... 50°C
Mechanical service life	Approx. 10^7 cycles
Standards/regulations	IEC 60664, EN 50178, IEC 62103
Connection data solid / stranded / AWG	0.2 - 2.5 mm ² / 0.2 - 2.5 mm ² / 24 - 14
Dimensions W / H / D	6.2 mm / 80 mm / 56 mm

Ordering data

Description	Input voltage U_N	Type	Order No.	Pcs. / Pkt.
Relay terminal block with power relay	① 24 V DC	DEK-REL-G24/21 ¹⁾	2964500	10

Accessories

Cover	No. of pos.	Color	D-DEK 1,5 GN	2716949	10	
Insertion bridge, for middle and lower levels	80	blue	EB 80- DIK BU	26 A	2715940	1
	80	red	EB 80- DIK RD	26 A	2715953	1
	80	white	EB 80- DIK WH	26 A	2715788	1

Relay modules

DEK series

DEK-REL-24/1/SEN input interface and DEK-REL-24/1/AKT output interface

In addition to the familiar advantages of the DEK-REL... electronic terminal blocks, such as

- 2-layer contact with hard gold-plating for universal applications from 1 mA to 5 A continuous current
- 2 kV_{rms} electrical isolation of input and output
- Integrated input circuit

With this terminal block, "ALL" connections for a sensor or actuator are provided over a width of just 6.2 mm!

This means that 16 outputs take up a total constructional width of just 105.4 mm (including the power terminal block).

Advantages:

- Lower costs as the N terminal block is no longer required
- Wiring is reduced to a minimum
- Up to 73% more space

Notes:	
Type of housing:	Polyamide PA non-reinforced, color: green.
Marking systems and mounting material	See Catalog 5
For the protection of relay coils and contacts, inductive loads must be dampened with an efficient protection circuit.	
For further EB...DIK... insertion bridges, refer to page 403	
1) EMC: Class A product, see page 571	

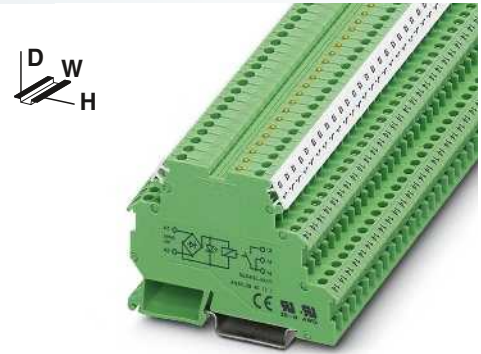

for small to medium loads
1 N/O contact (1)

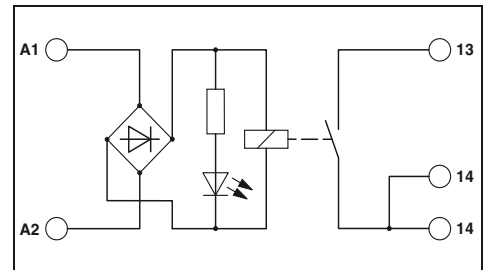

Technical data

Input data		①	②
Permissible range (with reference to U _N)		0.9 - 1.1	0.8 - 1.1
Typ. input current at U _N	[mA]	23	6.5
Response/release time at U _N	[ms]	8 / 15	5 / 15
Input protection:		Yellow LED, Bridge rectifier	
Output data			
Contact type		Double contact, 1 N/O contact	
Contact material		AgNi, hard gold-plated	
Max. switching voltage		250 V AC / 125 V DC	
Min. switching voltage		0.1 V	
Limiting continuous current		3 A (5 A up to 35°C at 24 V DC)	
Max. inrush current		5 A	
Min. switching current		1 mA	
Max. interrupting rating, ohmic load		24 V DC	72 W
		48 V DC	60 W
		60 V DC	50 W
		110 V DC	50 W
		250 V AC	750 VA
General data			
Test voltage (winding / contact)		2 kV AC (50 Hz, 1 min.)	
Ambient temperature (operation)		-20°C ... 50°C	
Mechanical service life		Approx. 2 x 10 ⁷ cycles	
Standards/regulations		IEC 60664, EN 50178, IEC 62103	
Connection data solid / stranded / AWG		0.2 - 2.5 mm ² / 0.2 - 2.5 mm ² / 24 - 14	
Dimensions		W / H / D 6.2 mm / 80 mm / 56 mm	

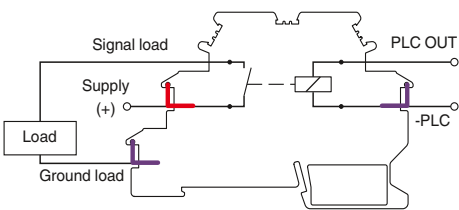

Pin configuration, DEK-REL...AKT

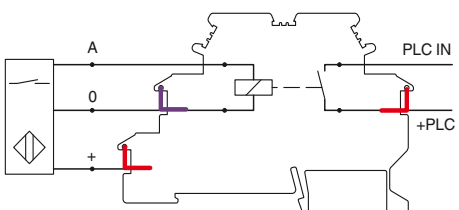

Pin configuration, DEK-REL...SEN

General data			
Test voltage (winding / contact)		2 kV AC (50 Hz, 1 min.)	
Ambient temperature (operation)		-20°C ... 50°C	
Mechanical service life		Approx. 2 x 10 ⁷ cycles	
Standards/regulations		IEC 60664, EN 50178, IEC 62103	
Connection data solid / stranded / AWG		0.2 - 2.5 mm ² / 0.2 - 2.5 mm ² / 24 - 14	
Dimensions		W / H / D 6.2 mm / 80 mm / 56 mm	

Ordering data

Description	Input voltage U _N	Type	Order No.	Pcs. / Pkt.
Relay terminal block with miniature relay	① 5 V AC/DC	DEK-REL- 5/I(1')	2941183	10
	② 24 V AC/DC	DEK-REL- 24/I(1')	2940171	10

Accessories

Terminal block, with three through contacts, for mounting on NS 35... For busbar feeding			
Cover			
Insertion bridge, for middle and lower levels		No. of pos.	Color
		80	blue
		80	red
		80	white
D-DEK 1,5 GN		2716949	10
EB 80- DIK BU		26 A	2715940
EB 80- DIK RD		26 A	2715953
EB 80- DIK WH		26 A	2715788

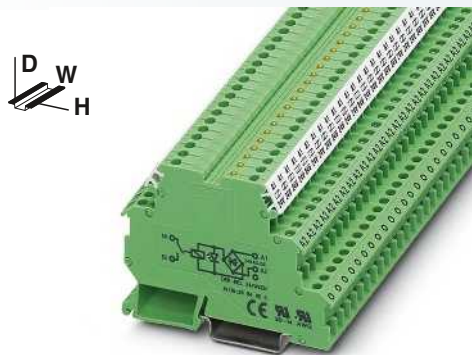

for small to medium loads
1 N/O contact (1)

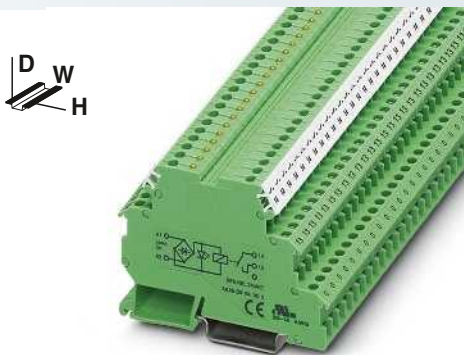

for small to medium loads
1 N/O contact (1)

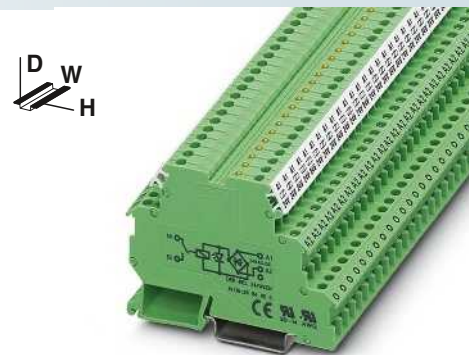

for small to medium loads
1 N/O contact (1)

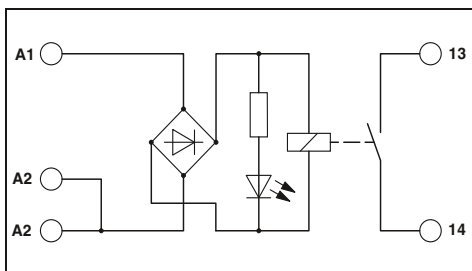

Technical data

① 0.9 - ② 0.8 -
1.1 1.1
23 6.5
8 / 15 5 / 15
Yellow LED, Bridge rectifier

Double contact, 1 N/O contact
AgNi, hard gold-plated
250 V AC / 125 V DC
0.1 V
3 A (5 A up to 35°C at 24 V DC)
5 A
1 mA

72 W
60 W
50 W
50 W
750 VA

2 kV AC (50 Hz, 1 min.)
-20°C ... 50°C
Approx. 2 x 10⁷ cycles
IEC 60664, EN 50178, IEC 62103
0.2 - 2.5 mm² / 0.2 - 2.5 mm² / 24 - 14
6.2 mm / 80 mm / 56 mm

Ordering data

Type	Order No.	Pcs. / Pkt.
DEK-REL- 5/O/1'1)	2941170	10
DEK-REL- 24/O/1'1)	2941154	10

Accessories

Accessories	Order No.	Pcs. / Pkt.
D-DEK 1,5 GN	2716949	10
EB 80- DIK BU	26 A 2715940	1
EB 80- DIK RD	26 A 2715953	1
EB 80- DIK WH	26 A 2715788	1

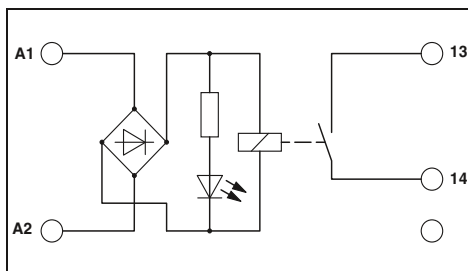

Technical data

① 0.8 -
1.1
6.5
5 / 15
Yellow LED, Bridge rectifier

Double contact, 1 N/O contact
AgNi, hard gold-plated
250 V AC / 125 V DC
0.1 V
3 A (5 A up to 35°C at 24 V DC)
5 A
1 mA

72 W
60 W
50 W
50 W
750 VA

2 kV AC (50 Hz, 1 min.)
-20°C ... 50°C
Approx. 2 x 10⁷ cycles
IEC 60664, EN 50178, IEC 62103
0.2 - 2.5 mm² / 0.2 - 2.5 mm² / 24 - 14
6.2 mm / 80 mm / 56 mm

Ordering data

Type	Order No.	Pcs. / Pkt.
DEK-REL- 24/1/AKT'1)	2964063	10

Accessories

Accessories	Order No.	Pcs. / Pkt.
DIKD 1,5	2715979	50
D-DEK 1,5 GN	2716949	10
EB 80- DIK BU	26 A 2715940	1
EB 80- DIK RD	26 A 2715953	1
EB 80- DIK WH	26 A 2715788	1

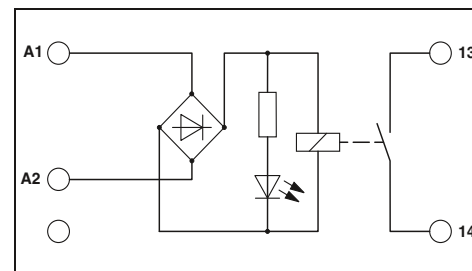

Technical data

① 0.8 -
1.1
6.5
5 / 15
Yellow LED, Bridge rectifier

Double contact, 1 N/O contact
AgNi, hard gold-plated
250 V AC / 125 V DC
0.1 V
3 A (5 A up to 35°C at 24 V DC)
5 A
1 mA

72 W
60 W
50 W
50 W
750 VA

2 kV AC (50 Hz, 1 min.)
-20°C ... 50°C
Approx. 2 x 10⁷ cycles
IEC 60664, EN 50178, IEC 62103
0.2 - 2.5 mm² / 0.2 - 2.5 mm² / 24 - 14
6.2 mm / 80 mm / 56 mm

Ordering data

Type	Order No.	Pcs. / Pkt.
DEK-REL- 24/1/SEN'1)	2964050	10

Accessories

Accessories	Order No.	Pcs. / Pkt.
DIKD 1,5	2715979	50
D-DEK 1,5 GN	2716949	10
EB 80- DIK BU	26 A 2715940	1
EB 80- DIK RD	26 A 2715953	1
EB 80- DIK WH	26 A 2715788	1

Relay modules

DEK series

DEK-OE... and DEK-OV... solid-state relay terminal blocks

Phoenix Contact DEK-OE and DEK-OV interface terminal blocks are only 6.2 mm wide but still provide a complete input or output interface with:

- Electrical isolation between input and output at up to 2.5 kV_{rms}
- Integrated input circuit
- Status display
- EB-DIK insertion bridges
- Labeling and mounting with modular terminal block convenience
- Wear-free switching up to 24 V DC/10 A and 240 V AC/800 mA
- Integrated output protection circuit
- Zero voltage switch at AC output
- Actuator version available.

Notes:	
Type of housing:	Polyamide PA non-reinforced, color: green.
Marking systems and mounting material	See Catalog 5
For the protection of input and output, inductive loads must be damped with an effective protection circuit.	
For further EB...DIK... insertion bridges, refer to page 403	
1) EMC: Class A product, see page 571	

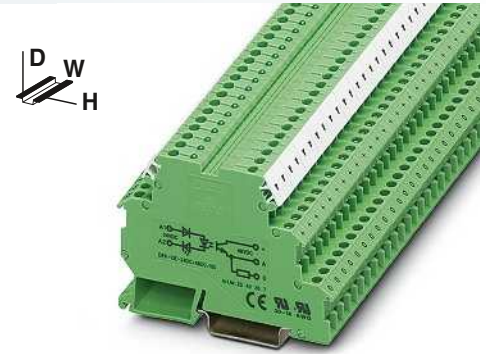

with DC voltage output
max. = 100 mA

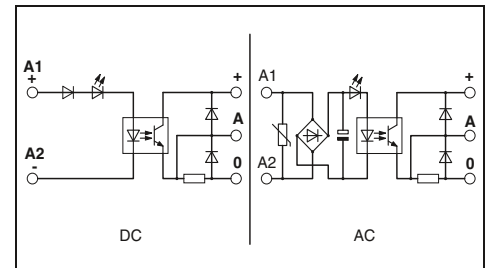

Derating curve for DEK-OV...24DC/3 and DEK-OV-24DC/24DC/3/AKT

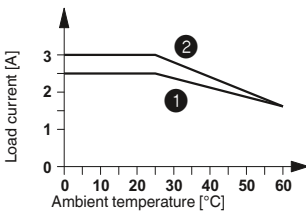

- 1) Horizontal mounting
- 2) Vertical mounting

Derating curve for DEK-OV-24DC/24DC/10

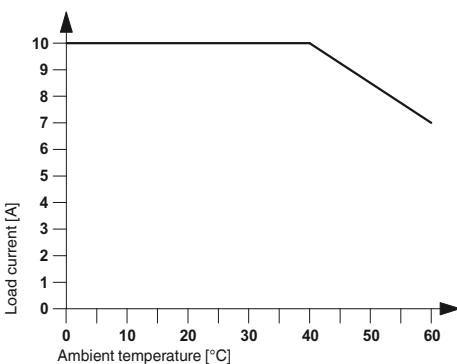

Derating curve for DEK-OV...240AC/800

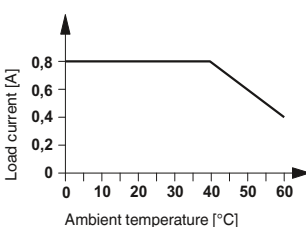

Input data	
Permissible range (with reference to U _N)	
Switching level with reference to U _N	1 signal ("H") ≥ 0.8 0 signal ("L") ≤ 0.4
Typ. input current at U _N	[mA]
Transmission frequency f _{limit}	[Hz]
Input circuit AC	
Input circuit DC	
Output data	
Operating voltage range	3 V DC ... 48 V DC
Periodic peak reverse voltage	-
Limiting continuous current	100 mA
Min. load current	-
Surge current	-
Leakage current in off state	-
Max. load value	-
Output protection	Protection against polarity reversal, freewheeling diode
Voltage drop at max. limiting continuous current	≤ 0.9 V
General data	
Test voltage input/output	2.5 kV (50 Hz, 1 min.)
Ambient temperature (operation)	-20°C ... 60°C
Standards/regulations	IEC 60664, EN 50178, IEC 62103
Pollution degree/surge voltage category	2 / III
Connection data solid / stranded / AWG	0.2 - 2.5 mm ² / 0.2 - 2.5 mm ² / 24 - 14
Dimensions	W / H / D

Technical data					
①	②	③	④	⑤	⑥
0.9 - 1.1	0.8 - 1.2	0.8 - 1.2	0.8 - 1.2	0.9 - 1.1	0.9 - 1.1
≥ 0.8	≥ 0.8	≥ 0.8	≥ 0.8	≥ 0.8	≥ 0.9
≤ 0.4	≤ 0.4	≤ 0.4	≤ 0.4	≤ 0.4	≤ 0.4
6.5	11	7	4	3.2	2.5
300	300	300	300	3	3

Yellow LED, Protection against polarity reversal, Surge protection

Yellow LED, Protection against polarity reversal

3 V DC ... 48 V DC
-
100 mA
-
-
-
-
Protection against polarity reversal, freewheeling diode
≤ 0.9 V

2.5 kV (50 Hz, 1 min.)
-20°C ... 60°C
IEC 60664, EN 50178, IEC 62103
2 / III
0.2 - 2.5 mm ² / 0.2 - 2.5 mm ² / 24 - 14
6.2 mm / 80 mm / 56 mm

Description	Input voltage U _N
Solid-state input relays	
①	5 V DC
②	12 V DC
③	24 V DC
④	60 V DC
⑤	120 V AC
⑥	230 V AC
Solid-state power relays	
①	5 V DC
②	12 V DC
③	24 V DC
Actuator principle	⑦ 24 V DC

Ordering data

Type	Order No.	Pcs. / Pkt.
DEK-OE- 5DC/ 48DC/100 ¹⁾	2940223	10
DEK-OE- 12DC/ 48DC/100 ¹⁾	2964487	10
DEK-OE- 24DC/ 48DC/100 ¹⁾	2940207	10
DEK-OE- 60DC/ 48DC/100 ¹⁾	2941536	10
DEK-OE-120AC/ 48DC/100	2941659	10
DEK-OE-230AC/ 48DC/100	2940210	10

Insertion bridge, for middle and lower levels	No. of pos.	Color
	80	blue
	80	red
	80	white

Accessories

Accessories	No. of pos.	Color
EB 80- DIK BU	26 A	2715940
EB 80- DIK RD	26 A	2715953
EB 80- DIK WH	26 A	2715788



with DC voltage output
max. = 3 A

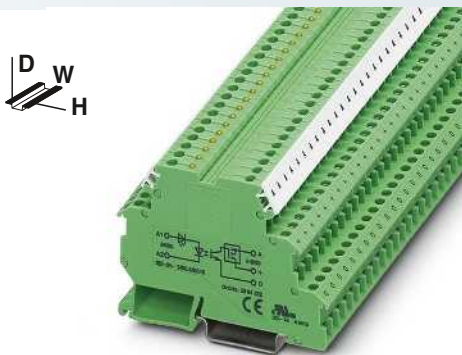

with DC voltage output
max. = 10 A



with AC voltage output
max. = 800 mA

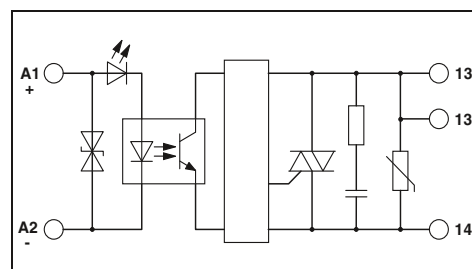
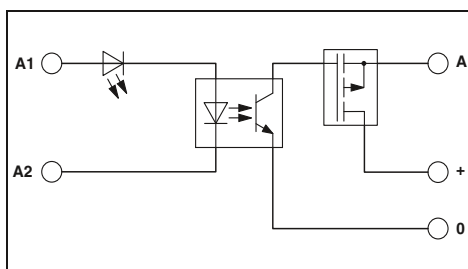
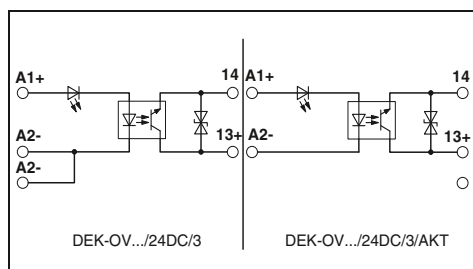

Technical data						
①	②	③	⑦	⑧	⑨	⑩
0.8 - 1.2	0.8 - 1.2	0.8 - 1.2	0.8 - 1.2	≥ 0.8	≤ 0.4	300
≥ 0.8	≥ 0.8	≥ 0.8	≥ 0.8	≤ 0.4	≤ 0.4	300
11	8.5	7	7			
300	300	300	300			

Technical data						
①	②	③	⑦	⑧	⑨	⑩
0.8 - 1.2	0.8 - 1.2	0.8 - 1.2	0.8 - 1.2	≥ 0.8	≤ 0.4	100
≥ 0.8	≥ 0.8	≥ 0.8	≥ 0.8	≤ 0.4	≤ 0.4	100
5.1	4.7	3.5	7			
100	100	100	100			

Technical data						
①	②	③	⑦	⑧	⑨	⑩
0.8 - 1.2	0.8 - 1.2	0.8 - 1.2	0.8 - 1.2	≥ 0.8	≤ 0.4	10
≥ 0.8	≥ 0.8	≥ 0.8	≥ 0.8	≤ 0.4	≤ 0.4	10
10.2	10.5	10.7	7			
10	10	10	10			

Yellow LED, Protection against polarity reversal

Yellow LED, Protection against polarity reversal, Surge protection

Yellow LED, Protection against polarity reversal, Surge protection

3 V DC ... 30 V DC
-
3 A (see derating curve)
-
-
-
Protection against polarity reversal, Surge protection ≤ 0.2 V

5 V DC ... 30 V DC
-
10 A (see derating curve)
-
100 A (t = 20 ms)
-
-
Protection against polarity reversal, Surge protection < 50 mV

10 V AC ... 253 V AC (50/60 Hz)
600 V
0.8 A (see derating curve)
10 mA
30 A (t = 10 ms)
1.2 mA
4.5 A ^{2s}
RCV circuit
≤ 1 V

2.5 kV (50 Hz, 1 min.)
-20°C ... 60°C
IEC 60664, EN 50178, IEC 62103
2 / III
0.2 - 2.5 mm ² / 0.2 - 2.5 mm ² / 24 - 14
6.2 mm / 80 mm / 56 mm

2.5 kV (50 Hz, 1 min.)
-20°C ... 60°C
IEC 60664, EN 50178, IEC 62103
2 / III
0.2 - 2.5 mm ² / 0.2 - 2.5 mm ² / 24 - 14
6.2 mm / 80 mm / 56 mm

2.5 kV (50 Hz, 1 min.)
-20°C ... 60°C
IEC 60664, EN 50178, IEC 62103
2 / III
0.2 - 4 mm ² / 0.2 - 2.5 mm ² / 24 - 12
6.2 mm / 80 mm / 56 mm

Ordering data		
Type	Order No.	Pcs. / Pkt.
DEK-OV- 5DC/ 24DC/ 3 ¹⁾	2941361	10
DEK-OV- 12DC/ 24DC/ 3 ¹⁾	2941387	10
DEK-OV- 24DC/ 24DC/ 3 ¹⁾	2941374	10
DEK-OV- 24DC/ 24DC/ 3/AKT	2964296	10

Ordering data		
Type	Order No.	Pcs. / Pkt.
DEK-OV- 5DC/ 24DC/ 10 ¹⁾	2961752	10
DEK-OV- 12DC/ 24DC/ 10 ¹⁾	2961749	10
DEK-OV- 24DC/ 24DC/ 10 ¹⁾	2964322	10

Ordering data		
Type	Order No.	Pcs. / Pkt.
DEK-OV- 5DC/240AC/800	2964623	10
DEK-OV- 12DC/240AC/800	2964636	10
DEK-OV- 24DC/240AC/800	2964649	10

Accessories			
Type	Order No.	Order No.	Pcs. / Pkt.
EB 80- DIK BU	26 A	2715940	1
EB 80- DIK RD	26 A	2715953	1
EB 80- DIK WH	26 A	2715788	1

Accessories			
Type	Order No.	Order No.	Pcs. / Pkt.
EB 80- DIK BU	26 A	2715940	1
EB 80- DIK RD	26 A	2715953	1
EB 80- DIK WH	26 A	2715788	1

Accessories			
Type	Order No.	Order No.	Pcs. / Pkt.
EB 80- DIK BU	26 A	2715940	1
EB 80- DIK RD	26 A	2715953	1
EB 80- DIK WH	26 A	2715788	1



DEK-REL-24/1/S switch/relay terminal block

The functions “Manual”, “0”, “Automatic” are provided in a 6.2 mm narrow relay terminal block.

Interference-free relay and solid-state relay interfaces

Coupled interference voltages on the coil lines or leakage currents can cause malfunctions in conventional modules. These special interface modules, equipped with high switching thresholds and/or effective filters, ensure good functioning.

ST-REL... and EMG 17-REL... relay interfaces for switching lamp loads

Lamp loads and capacitive consumers produce extremely high inrush currents which weld conventional relay contacts. To prevent this, Phoenix Contact uses an arc-resistant contact optimized for these applications, which keeps these peaks under control.

ST-OV 3-24DC/400/3 plug-in solid-state power relay

The output of this component, dimensioned with a peak reverse voltage of 800 V, allows, for example, 230 V motors to be driven in simple reversible mode.

Power circuit breaker solid-state relay, with signal logic

These modules combine the features of a short-circuit-proof power solid-state relay and those of a thermomagnetic protection element.

DEK-OE-...100KHZ 100 kHz input solid-state relay

Input solid-state relay for reliable transmission of high frequency signals of the type that occur with, for example, incremental encoders.

Electronic sensor terminal block for NAMUR proximity sensors

For converting the changeable resistance of a NAMUR sensor into a digital signal that can be read by a PLC.

DEK-TR/INV inverter module

Module for converting NPN outputs to PNP outputs and PNP to NPN.

Relay module with manual switch

Relay module with manual switch and integrated power relay for manual, zero, and automatic functions

The advantages:

- Max. switching current of 5 A
- Only 6.2 mm wide
- Increased contact stability thanks to double contact
- Safe isolation according to DIN EN 50178 between coil and contact

Notes:
Type of housing: Polyamide PA non-reinforced, color: green.
Marking systems and mounting material See Catalog 5
For the protection of input and output, inductive loads must be damped with an effective protection circuit.
1) EMC: Class A product, see page 571

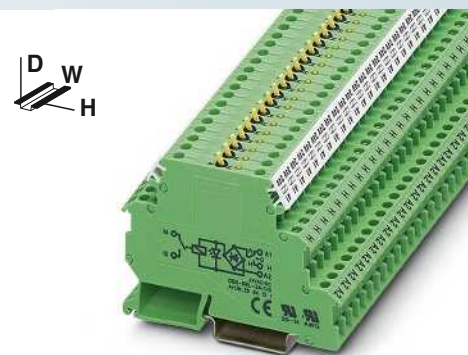

Relay module with manual switch and integrated relay

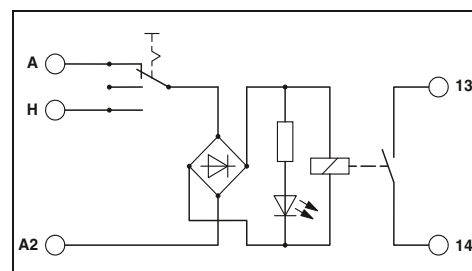

Technical data

Input data	①
Permissible range (with reference to U_N)	0.8 - 1.1
Typ. input current at U_N [mA]	6.5
Response/release time at U_N [ms]	5 / 15
Input protection:	Yellow LED, Bridge rectifier
Output data	
Contact type	Double contact, 1 N/O contact
Contact material	AgNi, hard gold-plated
Max. switching voltage	250 V AC / 125 V DC
Min. switching voltage	0.1 V
Limiting continuous current	3 A (5 A up to 35°C at 24 V DC)
Max. inrush current	5 A
Min. switching current	1 mA
Max. interrupting rating, ohmic load	
	24 V DC 72 W
	48 V DC 60 W
	60 V DC 50 W
	110 V DC 50 W
	250 V AC 750 VA
General data	
Test voltage (winding / contact)	2 kV AC (50 Hz, 1 min.)
Ambient temperature (operation)	-20°C ... 50°C
Mechanical service life	Approx. 2×10^7 cycles
Standards/regulations	IEC 60664, EN 50178, IEC 62103
Connection data solid / stranded / AWG	0.2 - 2.5 mm ² / 0.2 - 2.5 mm ² / 24 - 14
Dimensions	W / H / D 6.2 mm / 80 mm / 61 mm

Ordering data

Description	Input voltage U_N	Type	Order No.	Pcs. / Pkt.
Relay module with power relay	① 24 V AC/DC	DEK-REL- 24/1/S1)	2964131	10

Accessories

Cover	No. of pos.	Color	D-DEK 1,5 GN	2716949	10
Insertion bridge	2	red	EB 2- DIK RD	2716693	10
	3	red	EB 3- DIK RD	2716745	10
	4	red	EB 4- DIK RD	2716758	10
	5	red	EB 5- DIK RD	2716761	10
	10	red	EB 10- DIK RD	2716774	10
	2	blue	EB 2- DIK BU	2716648	10
	3	blue	EB 3- DIK BU	2716651	10
	4	blue	EB 4- DIK BU	2716664	10
	5	blue	EB 5- DIK BU	2716677	10
	10	blue	EB 10- DIK BU	2716680	10
	80	blue	EB 80- DIK BU	2715940	1
	80	red	EB 80- DIK RD	2715953	1
	80	white	EB 80- DIK WH	2715788	1

Relay modules

Special relays and solid-state relays

Relay modules with interference current filter

Relay and solid-state relay modules with integrated filter to protect against interference voltages or currents due, for example, to long control lines

The advantages:

- Resistant to interference currents
- High relay release voltage

Typical applications:

- Applications with long control lines
- Use of AC output boards, resulting in residual AC currents

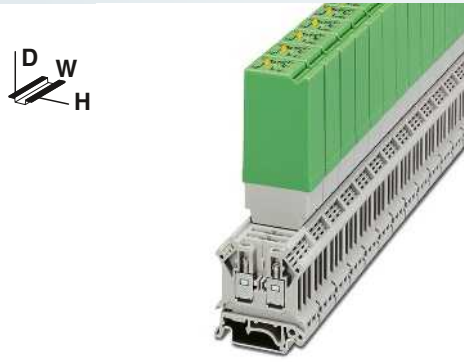

1 PDT, plug-in relay



1 PDT, soldered-in relay

Notes:
Load current diagrams, see page 347

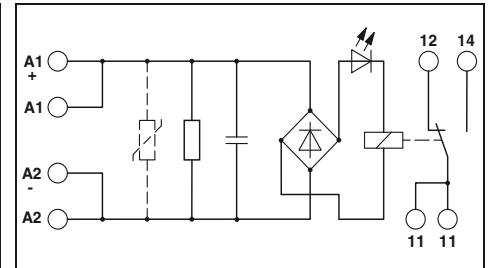
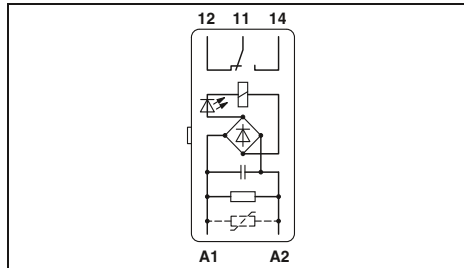

Technical data

	①	②	③
Permissible range (with reference to U_N)	0.9 - 1.1	0.85 - 1.1	0.9 - 1.1
Typ. input current at U_N [mA]	26	19	18
Response/release time at U_N [ms]	8 / 10	8 / 11	10 / 8
Input protection:	Yellow LED, Bridge rectifier, Surge protection		

Technical data

	③
Permissible range (with reference to U_N)	0.9 - 1.1
Typ. input current at U_N [mA]	18
Response/release time at U_N [ms]	10 / 8
Input protection:	Yellow LED, Bridge rectifier, Surge protection

Input data	
Permissible range (with reference to U_N)	
Typ. input current at U_N [mA]	
Response/release time at U_N [ms]	
Input protection:	
Output data	
Contact type	
Contact material	
Max. switching voltage	
Limiting continuous current	
Max. inrush current	
Max. interrupting rating, ohmic load	
General data	
Test voltage (winding / contact)	
Ambient temperature (operation)	
Mechanical service life	
Standards/regulations	
Connection data solid / stranded / AWG	
Dimensions	W / H / D

Technical data	
Single contact, 1-PDT	Double contact, 1 PDT
AgNi	Au
250 V AC/DC	30 V AC / 36 V DC
6 A	0.5 A
8 A	0.2 A
24 V DC	140 W
48 V DC	60 W
60 V DC	45 W
110 V DC	35 W
220 V DC	55 W
250 V AC	1500 VA
2.5 kV AC (50 Hz, 1 min.)	
-20°C ... 50°C	
Approx. 2 x 10 ⁷ cycles	
IEC 60664, EN 50178, IEC 62103	
- / - / -	
20.8 mm / 42.5 mm / 112 mm	

Technical data	
Single contact, 1-PDT	Double contact, 1 PDT
AgNi	AgPd60, hard gold-plated
250 V AC/DC	30 V AC / 36 V DC
6 A	0.5 A
8 A	0.2 A
95 W	5 W
50 W	-
45 W	-
35 W	-
55 W	-
1500 VA	-
2.5 kV AC (50 Hz, 1 min.)	
-20°C ... 40°C	
Approx. 2 x 10 ⁷ cycles	
IEC 60664, EN 50178, IEC 62103	
0.2 - 4 mm ² / 0.2 - 2.5 mm ² / 24 - 12	
22.5 mm / 75 mm / 62.5 mm	

Ordering data

Description	Input voltage U_N
Relay module with power contact relay	① 24 V AC
	② 120 V AC
	③ 230 V AC
Relay module with multi-layer contact relay	① 24 V AC
	② 120 V AC
	③ 230 V AC

Type	Order No.	Pcs. / Pkt.
ST-REL3-KG 24/21/SO46	2826091	10
ST-REL3-KG120/21/SO46	2833026	10
ST-REL3-KG230/21/SO46	2832027	10
ST-REL3-KG 24/21/AU/SO46	2826981	10
ST-REL3-KG120/21/AU/SO46	2829797	10
ST-REL3-KG230/21/AU/SO46	2826266	10

Ordering data

Type	Order No.	Pcs. / Pkt.
EMG 22-REL/KSR-230/21/ SO46	2940760	10
EMG 22-REL/KSR-230/21/AU/SO46	2940061	10

Accessories

Basic terminal block, complete with end cover	
Equipment marker	

URELG 3	2820136	10
---------	---------	----

Accessories

EMG-GKS 12	2947035	50
------------	---------	----

Notes:	
Type of housing:	
ST-REL: Polyamide non-reinforced PA, color: bottom part gray, hood green	
EMG: Polyamide fiber reinforced PA-F, color: green.	
DEK: Polyamide non-reinforced PA, color: green.	
Marking systems and mounting material See Catalog 5	
For derating curve, refer to page 345	
1) EMC: Class A product, see page 571	

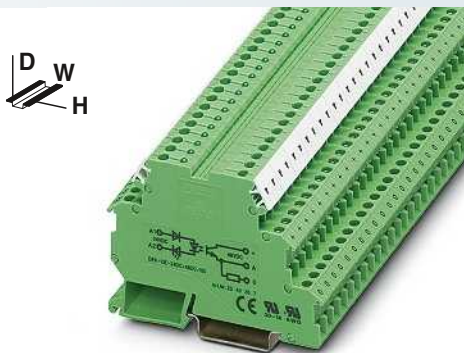

Solid-state input relay
100 mA, maximum



Solid-state power relay
Max. 2 A

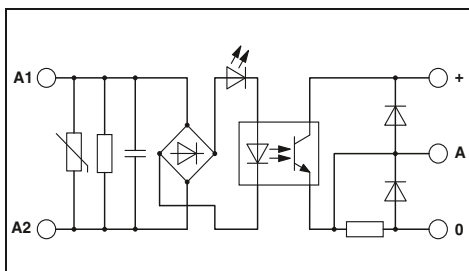

Technical data

Input data	②
Permissible range (with reference to U_N)	0.9 - 1.1
Switching level	1 signal ("H") [V DC] \geq 207 0 signal ("L") [V DC] \leq 92
Typ. input current at U_N	[mA] 2.5
Typ. switch-on time at U_N	[ms] 4.4
Typ. switch-off time at U_N	[ms] 14
Transmission frequency f_{limit}	[Hz] 5
Input circuit AC	Yellow LED, Surge protection, RC element
Input circuit DC	
Output data	
Max. switching voltage	48 V DC
Min. switching voltage	3 V DC
Limiting continuous current	100 mA
Max. inrush current	-
Output circuit	3-conductor, ground-referenced
Output protection	Protection against polarity reversal, Free running
Voltage drop at max. limiting continuous current	≤ 0.9 V
General data	
Test voltage input/output	2.5 kV AC
Ambient temperature (operation)	0°C ... 50°C
Standards/regulations	IEC 60664, EN 50178, IEC 62103
Pollution degree/surge voltage category	2 / III
Mounting position/mounting	Any / In rows with zero spacing
Connection data solid / stranded / AWG	0.2 - 4 mm ² / 0.2 - 2.5 mm ² / 24 - 12
Dimensions	W / H / D 6.2 mm / 80 mm / 56 mm

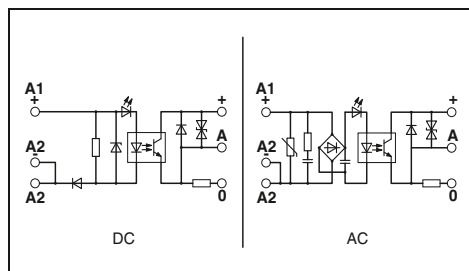

Technical data

Input data	①
Permissible range (with reference to U_N)	0.8 - 1.2
Switching level	16.8
Typ. input current at U_N	16
Typ. switch-on time at U_N	8
Typ. switch-off time at U_N	0.02
Transmission frequency f_{limit}	0.2
Input circuit AC	300
Input circuit DC	Protection against polarity reversal
Output data	
Max. switching voltage	48 V DC
Min. switching voltage	12 V DC
Limiting continuous current	2 A (see derating curve)
Max. inrush current	5 A ($t = 1$ s)
Output circuit	3-conductor, ground-referenced
Output protection	Protection against polarity reversal, Surge protection
Voltage drop at max. limiting continuous current	1.1 V
General data	
Test voltage input/output	3.5 kV AC
Ambient temperature (operation)	-10°C ... 55°C
Standards/regulations	IEC 60664, EN 50178, IEC 62103
Pollution degree/surge voltage category	2 / III
Mounting position/mounting	- / Mounted in rows with zero spacing; Horizontal/not in rows: Any
Connection data solid / stranded / AWG	0.2 - 4 mm ² / 0.2 - 2.5 mm ² / 24 - 12
Dimensions	W / H / D 17.5 mm / 75 mm / 102 mm

Input data	②
Permissible range (with reference to U_N)	0.9 - 1.1
Switching level	1 signal ("H") [V DC] \geq 207 0 signal ("L") [V DC] \leq 92
Typ. input current at U_N	[mA] 2.5
Typ. switch-on time at U_N	[ms] 4.4
Typ. switch-off time at U_N	[ms] 14
Transmission frequency f_{limit}	[Hz] 5
Input circuit AC	Yellow LED, Surge protection, RC element
Input circuit DC	
Output data	
Max. switching voltage	48 V DC
Min. switching voltage	3 V DC
Limiting continuous current	100 mA
Max. inrush current	-
Output circuit	3-conductor, ground-referenced
Output protection	Protection against polarity reversal, Free running
Voltage drop at max. limiting continuous current	≤ 0.9 V
General data	
Test voltage input/output	2.5 kV AC
Ambient temperature (operation)	0°C ... 50°C
Standards/regulations	IEC 60664, EN 50178, IEC 62103
Pollution degree/surge voltage category	2 / III
Mounting position/mounting	Any / In rows with zero spacing
Connection data solid / stranded / AWG	0.2 - 4 mm ² / 0.2 - 2.5 mm ² / 24 - 12
Dimensions	W / H / D 6.2 mm / 80 mm / 56 mm

Description	Input voltage U_N
Solid-state power relays	① 24 V DC
	② 230 V AC

Ordering data			
Type	Order No.	Pcs. / Pkt.	
DEK-OE-230AC/ 48DC/100/SO 46	2964678	10	

Equipment marker	
-------------------------	--

Accessories			

Ordering data			
Type	Order No.	Pcs. / Pkt.	
EMG 17-OV- 24DC/ 48DC/2 ¹)	2942810	10	

Accessories			
EMG-GKS 12	2947035	50	

Relay modules

Special relays and solid-state relays

Relay modules for high inrush currents

The Phoenix Contact relay modules of the type SO 38 have been designed for switching electrical equipment with high inrush currents.

Areas of application are:

- Inductive loads (motors, power contactors, etc.)
- Inductive/capacitive loads (fluorescent lamps, etc.)
- Ohmic loads (glow lamps, heaters).

The module is based on a relay with a special arc-resistant tungsten lead contact. This takes over the high inrush and interrupting current capacitively. The inductive main contact made of AgCdO takes over the continuous current up to 10 A reliably. With the EMG 17-REL...2E/SO38 model, this switching capacity is reached using a power relay with a set of silver tin oxide (AgSnO) contacts.

The module is available in two versions:

- Modular EMG rail-mountable housing with a design width of 17.5 mm
- Convenient ST-REL plug-in housing from the Phoenix ST series for mounting on the URELG or UDK-RELG basic terminal blocks.

Further features are:

- Snap-on mounting on the common EN rails
- Easy maintenance
- Clear labeling of the terminal blocks using Phoenix Contact marking material.

Notes:
Type of housing: Polycarbonate fiber reinforced PC-F, color: green or black.
Marking systems and mounting material See Catalog 5



medium to large loads
1 N/O contact (1)

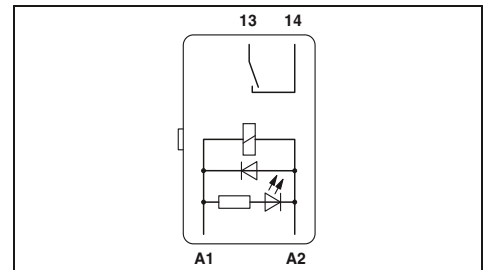

Technical data

Input data	①
Permissible range (with reference to U_N)	0.85 - 1.1
Typ. input current at U_N	[mA] 28
Response/release time at U_N	[ms] 13 / 15
Input protection:	Yellow LED, freewheeling diode
Output data	
Contact type	1 N/O contact with lead contact
Contact material	AgCdO
Max. switching voltage	250 V AC
Limiting continuous current	10 A
Max. inrush current	80 A (20 ms)
Max. interrupting rating, ohmic load	
	24 V DC -
	48 V DC -
	60 V DC -
	110 V DC -
	220 V DC -
	250 V AC 2500 VA
General data	
Test voltage (winding / contact)	2.5 kV AC (50 Hz, 1 min.)
Ambient temperature (operation)	-20°C ... 50°C
Mechanical service life	Approx. 10 ⁷ cycles
Standards/regulations	IEC 60664, EN 50178, IEC 62103
Mounting position/mounting	- / Horizontal with zero spacing, vertical with spacing
Connection data solid / stranded / AWG	- / - / -
Dimensions	W / H / D 20.8 mm / 42.5 mm / 112 mm

Ordering data

Description	Input voltage U_N	Type	Order No.	Pcs. / Pkt.
Relay module with power contact relay + wolfram lead contact				
	① 24 V DC			
Relay module with power contact relay, with two inputs for manual, automatic				
	① 24 V DC	ST-REL3-KG 24/ 1/SO38	2829564	10

Accessories

Basic terminal block, complete with end cover	URELG 3	2820136	10
Equipment marker			



medium to large loads
1 N/O contact (1)

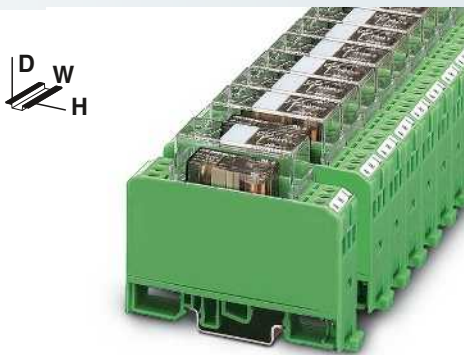

medium to large loads
1 N/O contact (1)

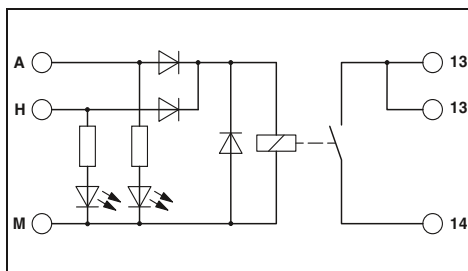
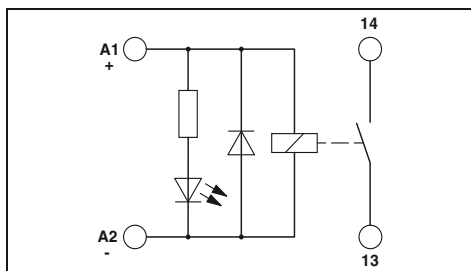

Technical data

Technical data

①
0.85 -
1.1
28
13 /
15
Yellow LED, freewheeling diode

①
0.9 -
1.1
23
9 / 10
Automatic: Yellow LED, Manual: Red LED, freewheeling diode, Protection against polarity reversal

1 N/O contact with lead contact
AgCdO
250 V AC
10 A
80 A (20 ms)

Single contact, 1 N/O contact
AgSnO
250 V AC/DC
10 A
120 A (20 ms)

-
-
-
-
-
2500 VA

240 W
120 W
85 W
70 W
90 W
2500 VA

4 kV AC (50 Hz, 1 min.)
-20°C ... 50°C
Approx. 10⁷ cycles
IEC 60664, EN 50178, IEC 62103
Any

4 kV AC (50 Hz, 1 min.)
-20°C ... 50°C
3 x 10⁷ cycles
IEC 60664, EN 50178, IEC 62103
Any

0.2 - 4 mm² / 0.2 - 2.5 mm² / 24 - 12
17.5 mm / 75 mm / 62.5 mm

0.2 - 4 mm² / 0.2 - 2.5 mm² / 24 - 12
17.5 mm / 75 mm / 62.5 mm

Ordering data

Ordering data

Type	Order No.	Pcs. / Pkt.
EMG 17-REL/KSR-G 24/SO38 BK	2949994	10

Type	Order No.	Pcs. / Pkt.
EMG 17-REL/KSR-G 24/2E/SO38	2941646	10

Accessories

Accessories

EMG-GKS 12	2947035	50
------------	---------	----

EMG-GKS 12	2947035	50
------------	---------	----

Relay modules

Special relays and solid-state relays

ST-OV 3 plug-in solid-state power relays

The plug-in version of the module provides all the advantages of the ST series, such as:

- Switching of up to 400 V AC/3 A
- Control of 230 V motors in straightforward reversing mode (e.g., synchronous motor in single-phase operation, see illustration)
- Plug-in

Notes:	
Type of insulating housing: polyamide PA non-reinforced, color: bottom part gray, hood green	
Ground (minus) potential from the input and output of the optocoupler should not be connected.	
AC loads must be protected with a varistor or an RC element.	



with AC voltage output
max. = 3 A

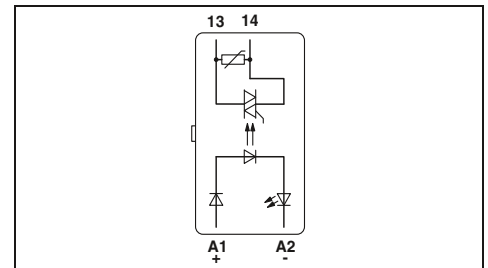

Technical data

Input data		①
Switching level with reference to U_N	1 signal ("H")	≥ 0.8
	0 signal ("L")	≤ 0.4
Typ. input current at U_N		[mA] 7
Transmission frequency f_{limit}		[Hz] 10
Input protection:		Yellow LED, Protection against polarity reversal, RC element
Output data		
Operating voltage		400 V AC
Operating voltage range		24 V AC ... 420 V AC
Periodic peak reverse voltage		800 V
Limiting continuous current		3 A (see derating curve)
Min. load current		50 mA
Surge current		125 A ($t = 10$ ms)
Residual voltage drop at "H"		≤ 1.2 V
Leakage current in off state		Approx. 12 mA
Output protection		Surge protection, RC element
General data		
Test voltage input/output		2.5 kV AC
Ambient temperature (operation)		0°C ... 60°C
Standards/regulations		IEC 60664, EN 50178, IEC 62103
Pollution degree/surge voltage category		2 / III
Mounting position/mounting		Horizontal DIN rail / -
Dimensions	W / H / D	20.8 mm / 42.5 mm / 112 mm

Ordering data

Description	Input voltage U_N	Type	Order No.	Pcs. / Pkt.
Solid-state power relays	① 24 V DC	ST-OV3- 24DC/400AC/3	2905417	10

Accessories

Basic terminal block, complete with end cover	URELG 3	2820136	10
--	---------	---------	----

Derating curve for ST-OV 3-24DC/400AC/3

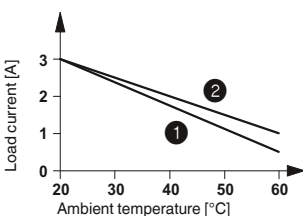

- ① Aligned without spacing
- ② Aligned with ≥ 20 mm spacing

ST-OV 4-24DC/24DC/...-PRO power protection circuit solid-state relay with signal logic

The ST-OV 4-...PRO provides protection and monitoring functions that are otherwise only known from thermomagnetic protection elements.

The PROtect modules have the following features:

- Fast disconnection with short-circuits and simultaneous current limitation
- Time-dependent overload shutdown for reliable protection against continuous overloads
- Brief inrush peaks are ignored
- After an overload or short-circuit has been triggered, a defined reset of the control voltage must be carried out
- Reliable recognition and indication of a line break on the load side
- Feedback in the event of an error

Notes:	
Type of housing:	Polyamide PA non-reinforced, color: bottom part gray, hood green
Marking systems and mounting material	See Catalog 5
For load current diagram, see page 347	
Derating curve, time/current characteristic curves, and state diagram, see page 347	

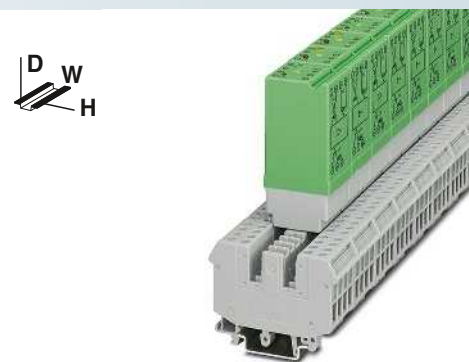

with short-circuit-proof DC voltage output
max. = 1 A or 4 A

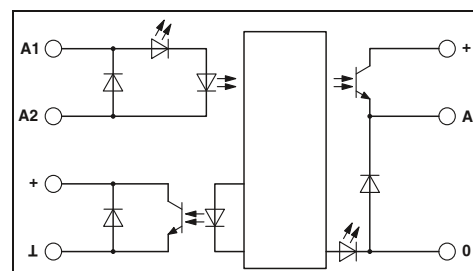

Technical data

Input data	ST-OV4- 24DC/ 24DC/1-PRO	ST-OV4- 24DC/ 24DC/4-PRO
Operating voltage	24 V DC ±50%	
Switching level	8.5 V DC	
	5 V DC	
Typ. input current at U _N	6.5 mA	
Transmission frequency f _{limit}	100 Hz	
Reset period after short-circuit / overload shut down	1 ms	
Input circuit	Yellow LED, Polarity protection diode	
Output data signaling contact / CONTROL		
Operating voltage range	5 V DC ... 36 V DC	
Limiting continuous current	50 mA	
Residual voltage drop at "H"	≤ 1.5 V	
Output protection	Polarity protection diode	
Output circuit	3-conductor, ground-referenced	
Output data load contact		
Operating voltage range	18 V DC ... 36 V DC	
Limiting continuous current	1 A (see derating curve)	4 A (see derating curve)
Min. load current	1 mA	
Residual voltage drop at "H"	300 mV	200 mV
Open circuit alarm with load current	< 100 μA	
Overload disconnection (~ 1.4 x continuous current)	≤ 100 ms (See the time-current characteristic curve)	
Short-circuit disconnection	< 200 μs (See the time-current characteristic curve)	
Current limitation at short-circuits	Approx. 25 A	Approx. 70 A
Switching time t _{in} / t _{out}	300 μs / 700 μs	
Output protection	Red LED, Damping diode	
Output circuit	3-conductor, ground-referenced	
General data		
Test voltage input/output	2.5 kV AC	
Test voltage output/output	2.5 kV AC	
Rated surge voltage	Basic insulation	
Ambient temperature (operation)	0°C ... 60°C	
Standards/regulations	IEC 60664 / EN 50178 / IEC 62103	
Screw connection solid / stranded / AWG	0.2 - 4 mm ² / 0.2 - 4 mm ² / 24 - 12	
Dimensions	W / H / D 27 mm / 63.5 mm / 114 mm	

Ordering data

Description	Output current	Type	Order No.	Pcs. / Pkt.
Power circuit breaker solid-state relay, with signal logic	1 A	ST-OV4- 24DC/ 24DC/1-PRO	2905572	10
	4 A	ST-OV4- 24DC/ 24DC/4-PRO	2905585	10

Accessories

Basic terminal block, complete with end cover	UDK-RELG 4	2777056	10
--	------------	---------	----

Relay modules

Special relays and solid-state relays

DEK-OE 100 kHz input solid-state relay

A solid-state relay for the reliable detection of short pulses

- Limit frequency of up to 100 kHz
- Push-pull stage on output side
- Includes signal inputs on PLC counter boards
- Features a capacitor on the input side for interference suppression

Notes:
Type of housing: Polyamide PA non-reinforced, color: green.
Marking systems and mounting material See Catalog 5
1) EMC: Class A product, see page 571

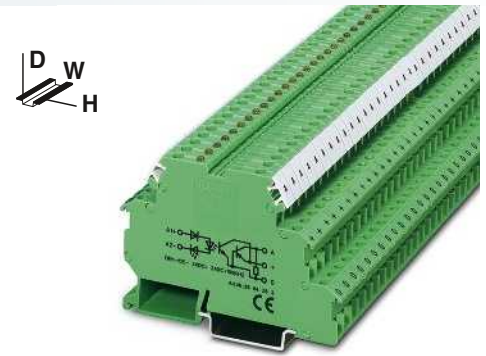

with DC voltage output
Transmission frequency 100 kHz

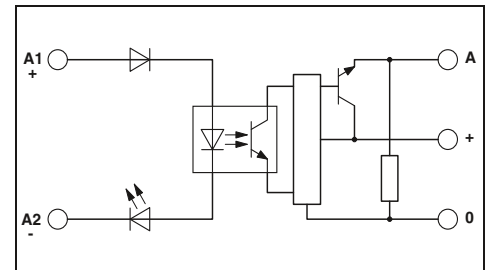

Technical data

Input data		①	②
Permissible range (with reference to U_N)		0.8 - 1.2	0.8 - 1.2
Switching level with reference to U_N	1 signal ("H")	≥ 0.8	≥ 0.8
	0 signal ("L")	≤ 0.4	≤ 0.4
Typ. input current at U_N	[mA]	7	6
Typ. switch-on time at U_N	[μ s]	1.5	1.5
Typ. switch-off time at U_N	[μ s]	2	2
Transmission frequency f_{limit}	[kHz]	100	100
Input protection:		Yellow LED, Protection against polarity reversal, Surge protection	
Output data			
Operating voltage range		4 V DC ... 30 V DC	
Limiting continuous current		50 mA	
Quiescent current		4.3 mA	
Residual voltage drop at "H"		≤ 0.5 V DC	
Output circuit		3-conductor, ground-referenced	
Output protection		Surge protection	
General data			
Test voltage input/output		2.5 kV AC	
Ambient temperature (operation)		-20°C ... 60°C	
Standards/regulations		IEC 60664, EN 50178, IEC 62103	
Pollution degree/surge voltage category		2 / II	
Connection data solid / stranded / AWG		0.2 - 4 mm ² / 0.2 - 2.5 mm ² / 24 - 12	
Dimensions	W / H / D	6.2 mm / 80 mm / 56 mm	

Ordering data

Description	Input voltage U_N	Type	Order No.	Pcs. / Pkt.
Solid-state input relays	① 5 V DC	DEK-OE- 5DC/ 24DC/100KHZ ¹⁾	2964270	10
	② 24 V DC	DEK-OE- 24DC/ 24DC/100KHZ ¹⁾	2964283	10



with DC voltage output push-pull
Transmission frequency 100 kHz



with DC voltage output push-pull
Transmission frequency 100 kHz

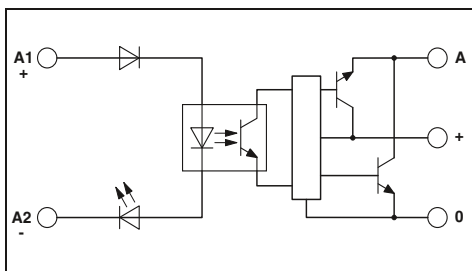

Technical data

①	②
0.5 - 1.2	0.8 - 1.2
≥ 0.5	≥ 0.8
≤ 0.3	≤ 0.4
8	8
1	1
2	2
100	100
Yellow LED, Protection against polarity reversal, Surge protection	

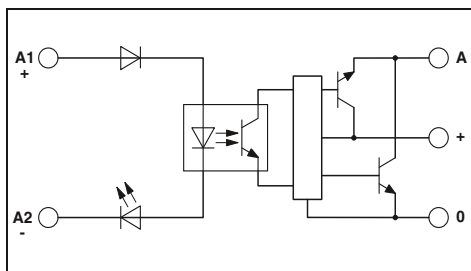

Technical data

①	②
0.5 - 1.2	0.8 - 1.2
≥ 0.5	≥ 0.8
≤ 0.3	≤ 0.4
8	8
1	1
2	2
100	100
Yellow LED, Protection against polarity reversal, Surge protection	

4 V DC ... 18 V DC
50 mA
8.5 mA
≤ 1.2 V DC
3-conductor push-pull, ground referenced
Surge protection

14 V DC ... 30 V DC
50 mA
15 mA
≤ 2.2 V DC
3-conductor push-pull, ground referenced
Surge protection

2.5 kV AC
-20°C ... 60°C
IEC 60664, EN 50178, IEC 62103
2 / II
0.2 - 4 mm² / 0.2 - 2.5 mm² / 24 - 12
6.2 mm / 80 mm / 56 mm

2.5 kV AC
-20°C ... 60°C
IEC 60664, EN 50178, IEC 62103
2 / II
0.2 - 4 mm² / 0.2 - 2.5 mm² / 24 - 12
6.2 mm / 80 mm / 56 mm

Ordering data

Type	Order No.	Pcs. / Pkt.
DEK-OE- 5DC/ 5DC/100KHZ-G ¹)	2964542	10
DEK-OE- 24DC/ 5DC/100KHZ-G ¹)	2964364	10

Ordering data

Type	Order No.	Pcs. / Pkt.
DEK-OE- 5DC/ 24DC/100KHZ-G ¹)	2964555	10
DEK-OE- 24DC/ 24DC/100KHZ-G ¹)	2964348	10

Relay modules

Special relays and solid-state relays

Electronic sensor terminal block for NAMUR proximity sensors

- The EIK 1-SVN 24-P electronic sensor terminal block from Phoenix Contact converts the changeable resistance of a NAMUR sensor unit into a digital signal that can be read by all PLCs.
- Monitoring of initiator side for short circuits or strand breaks
 - Suitable resistance circuit to enable monitoring of mechanical switches (see application 2)
 - LED error display
 - Status display (high signal) via green LED
 - 24 V/50 mA digital output
 - Bridging and marking with standard terminal accessories.

Notes:
Type of housing: Polyamide PA non-reinforced, color: green.
Marking systems and mounting material See Catalog 5
1) EMC: Class A product, see page 571

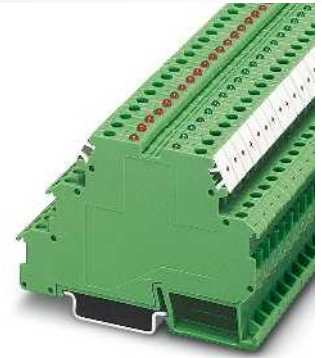

For inductive proximity sensors according to NAMUR

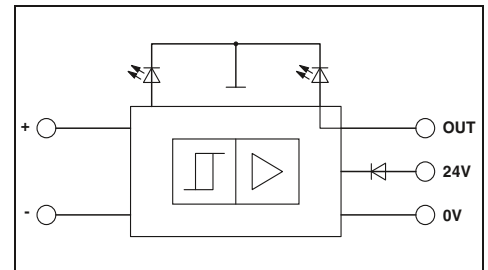

Derating curve for EIK 1-SVN 24 P

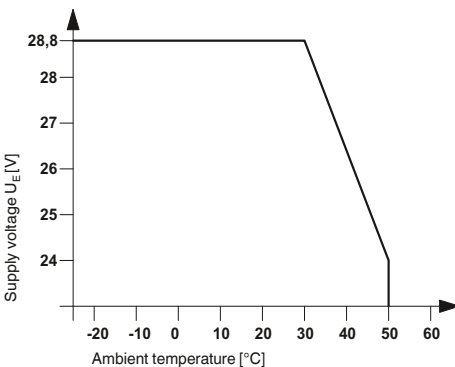

Supply	Input supply nominal voltage U_{VN}
Ripple	Current consumption I_{Imax} Input circuit
Control circuit	Non-load voltage Switching points in accordance with EN 60947-5-6:
Switching hysteresis	
Internal resistance	
Output protection	
Signal output	Max. output current I_{Omax} Residual voltage U_R with I_{Omax} Output voltage U_O
Output protection	
General data	Ambient temperature (operation) Transmission frequency (INPUT/OUTPUT) Input pulse length Input pause length Standards/regulations Pollution degree / Surge voltage category Screw connection solid / stranded / AWG Dimensions

Technical data	18.5 V DC ... 28.8 V DC (U_{VN} , see derating curve)
	according to DIN 19240 70 mA (at 50 mA output current) Green LED, Polarity protection diode
	8.2 V DC $\pm 10\%$ ≥ 2.1 mA (In conductive state) ≤ 1.2 mA (In blocking state) 6.3 mA ... 10 mA (in the event of a short-circuit) 0 mA ... 0.35 mA (In the event of a wire break) Approx. 0.2 mA Approx. 1 k Ω visual short-circuit and wire break control with LED (red), 12 V Zener diode
	50 mA ≤ 1.5 V (U_R) ≤ 100 mV (In conductive state) ($U_{VN} - U_R$; in blocking state) 36 V Zener diode as freewheeling diode
	-25°C ... 50°C 1 kHz ≥ 0.5 ms ≥ 0.5 ms IEC 60664, EN 61000-6-2, EN 61000-6-4 2 / III 0.2 - 4 mm ² / 0.2 - 2.5 mm ² / 24 - 12 6.2 mm / 80 mm / 56 mm

Application 1

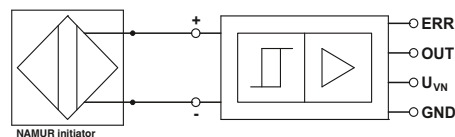

Application 2

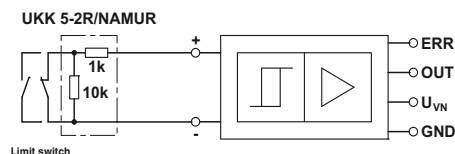

Description	Switching amplifier electronic terminal block , for inductive proximity initiators as per NAMUR, with light indicators for sensor signal and faults
Terminal block , with three through contacts, for mounting on NS 35...	
Double-level terminal block , with pre-assembled resistors	
Insertion bridge	

Ordering data		
Type	Order No.	Pcs. / Pkt.
EIK1-SVN-24P ¹⁾	2940799	10
Accessories		
DIKD 1,5	2715979	50
UKK 5-2R/NAMUR	2941662	50
EB...DIK...		
Ordering data at DEK-REL...		

DEK-TR/INV inverter module

The Phoenix Contact DEK-TR/INV inverter module inverts the signals of ground switching NPN transistor outputs into positive switching PNP outputs, and vice versa (see application example).

Notes:
Type of housing: Polyamide PA non-reinforced, color: green.
Marking systems and mounting material See Catalog 5

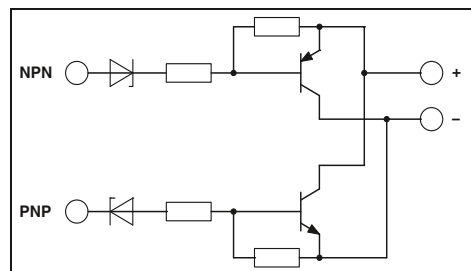
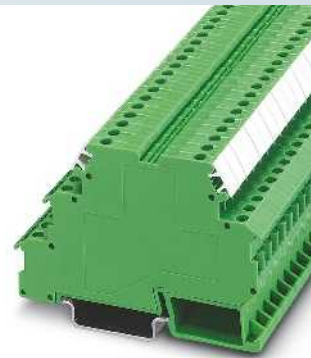

Technical data

Supply voltage	20 V DC ... 30 V DC (U_V)
Continuous current	200 mA
Residual voltage drop	< 1 V
Leakage current	< 1 mA
Max. transmission frequency	15 kHz
NPN input/PNP output	
Switch-on threshold	< 5 V (at $U_V = 24$ V; < ($U_V - 19$ V))
Switch-off threshold	> 15 V (at $U_V = 24$ V; > ($U_V - 9$ V))
Min. limit values	-2 V
Max. limit values	26 V (at $U_V = 24$ V; $U_V + 2$ V)
Control circuit	
Switch-on threshold	> 19 V
Switch-off threshold	< 9 V
Min. limit values	-2 V
Max. limit values	26 V (at $U_V = 24$ V; $U_V + 2$ V)
General data	
Ambient temperature (operation)	-20°C ... 50°C
Standards/regulations	IEC 60664
	Basic insulation
	2 / II
Pollution degree / Surge voltage category	0.2 - 4 mm ² / 0.2 - 2.5 mm ² / 24 - 12
Screw connection solid / stranded / AWG	
Dimensions	6.2 mm / 80 mm / 56 mm

Ordering data

Description	Type	Order No.	Pcs. / Pkt.
Inverter module	DEK-TR/INV	2964319	10

Connection examples:

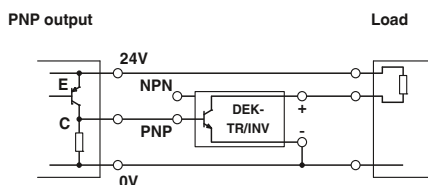
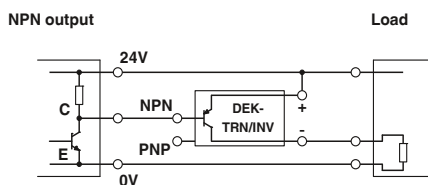

Relay modules

Special relays and solid-state relays

Hybrid relay modules

With its integrated transistor level, the hybrid relay module is able to amplify weak input signals. This serves as the basis for reliable relay operation.

The advantages:

- Low control current (terminal B), type-dependent as of 0.5 mA
- Type-dependent positive or negative control current
- Integrated input and interference suppression circuit
- Safe isolation according to DIN EN 50178 between coil and contact

Notes:
Type of housing: Polycarbonate fiber reinforced PC-F, color: green.
Marking systems and mounting material See Catalog 5
For the protection of relay coils and contacts, inductive loads must be dampened with an efficient protection circuit.
1) EMC: Class A product, see page 571

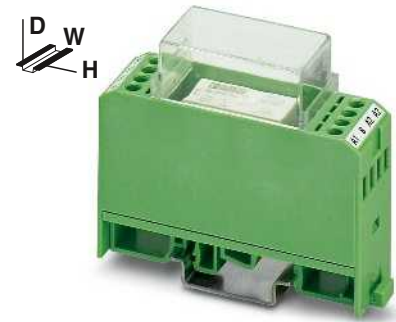

Positive switching hybrid relay

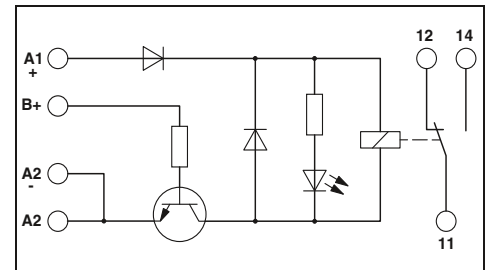

Technical data

Input data	①	②	③
Relay supply voltage $U_N \pm 10\%$	24	24	24
Min. control voltage	2.7	5	15
Max. control voltage	5.25	13.2	35
Min. control current	2.6	0.5	0.5
Max. control current	7.7	1	1
Typ. input current at U_N	21	21	21
Response/release time at U_N	9 / 10	9 / 10	9 / 10
Input protection:	Yellow LED, Protection against polarity reversal, freewheeling diode		
Output data			
Contact type	Single contact, 1-PDT		
Contact material	AgNi		
Max. switching voltage	250 V AC/DC		
Limiting continuous current	5 A		
Max. inrush current	8 A		
Max. interrupting rating, ohmic load	24 V DC	120 W	
	48 V DC	60 W	
	60 V DC	50 W	
	110 V DC	50 W	
	220 V DC	80 W	
	250 V AC	1250 VA	

General data	W / H / D
Test voltage (winding / contact)	4 kV AC (50 Hz, 1 min.)
Ambient temperature (operation)	-20°C ... 50°C
Mechanical service life	Approx. 5×10^7 cycles
Standards/regulations	IEC 60664, EN 50178, IEC 62103
Pollution degree/surge voltage category	2 / III
Connection data solid / stranded / AWG	0.2 - 4 mm ² / 0.2 - 2.5 mm ² / 24 - 12
Dimensions	22.5 mm / 75 mm / 62.5 mm

Ordering data

Description	Nominal control voltage
Relay module with miniature power contact relay with integrated NPN transistor control, for low control currents	① 5 V DC
	② 12 V DC
	③ 24 V DC
Relay module with miniature power contact relay with integrated PNP transistor control, for low control currents	① 5 V DC
	② 12 V DC
	③ 24 V DC

Type	Order No.	Pcs. / Pkt.
EMG 22-REL/KSR-G 24/TRN 5 ¹⁾	2949787	10
EMG 22-REL/KSR-G 24/TRN12 ¹⁾	2952363	10
EMG 22-REL/KSR-G 24/TRN35 ¹⁾	2952350	10

Accessories

Equipment marker	EMG-GKS 12	2947035	50
------------------	------------	---------	----



Negative switching hybrid relay



Technical data

①	②	③
24	24	24
-2.4	-6.9	-17.5
-5.25	-13.2	-38.5
1.2	0.6	0.6
1.7	1	1.4
21	21	21
9 / 10	9 / 10	9 / 10

Yellow LED, Protection against polarity reversal, freewheeling diode

Single contact, 1-PDT

AgNi
250 V AC/DC
5 A
8 A

120 W
60 W
50 W
50 W
80 W
1250 VA

4 kV AC (50 Hz, 1 min.)
-20°C ... 50°C
Approx. 5 x 10⁷ cycles
IEC 60664, EN 50178, IEC 62103
2 / III
0.2 - 4 mm² / 0.2 - 2.5 mm² / 24 - 12
22.5 mm / 75 mm / 62.5 mm

Ordering data

Type	Order No.	Pcs. / Pkt.
EMG 22-REL/KSR-G 24/TRP 5 ¹⁾	2949790	10
EMG 22-REL/KSR-G 24/TRP12 ¹⁾	2952156	10
EMG 22-REL/KSR-G 24/TRP35 ¹⁾	2952169	10

Accessories

EMG-GKS 12	2947035	50
------------	---------	----



System cabling for controllers

Wiring I/O modules with individual wires is an extremely time-consuming process. Wiring errors and tedious troubleshooting cannot be ruled out.

Interface cabling reduces assembly costs by using plug-in components to carry out wiring quickly, clearly, and without errors.

The new interface modules in the VIP - VARIOFACE Professional series, which feature a modern housing design, offer the following advantages:

- Space-saving
- Vibration resistant up to 5g thanks to metal feet
- Reliable connection technology, either with screw or push-in connections
- Wide range of marking options

VIP modules are available for both product segments:

VARIOFACE system cabling is a cabling concept that has been specially developed to allow connection to the I/O modules of a wide range of automation devices.

The VIP series is rounded off by new front adapters with encapsulated system cables for the SIMATIC S7 300.

VARIOFACE wiring interfaces are suitable for universal use. Various VIP - VARIOFACE Professional modules with a 1:1 connection from a high-position plug-in connector to a different connection technology are available. The encapsulated system cables provide an effective and efficient means of establishing a connection to a control device with protection against polarity reversal.

A variety of potential distributors are available for splitting the control and operating voltage.

Product range overview

Introduction to VARIOFACE system cabling	418
<hr/>	
Overview of VARIOFACE system cabling	420
<hr/>	
Front adapter	
For ABB S800 I/O	422
For Allen-Bradley, ControlLogix, PLC 5, SLC 500, and PlantScape	424
For Emerson DeltaV	432
For GE Fanuc RX3i and Series 90-30	436
For Honeywell C300 Series CI/O and PlantScape	438
For Mitsubishi A1S and Q, Melsec L, Honeywell ML 200	440
For Omron CJ1, CS1, and C200H	442
For Phoenix Contact Axioline and Inline	443
For Schneider Electric MODICON®	445
For Siemens SIMATIC® S7-300	450
For Siemens SIMATIC® S7-1500	456
For Siemens SIMATIC® S7-400	458
For Siemens SIMATIC® S5-S7 conversion	459
For Yokogawa CS3000 R3	466
<hr/>	
Termination boards	
With passive transfer	470
With relay	490
<hr/>	
PLC-INTERFACE via V8 adapter	
V8 adapter	484
Feed-through terminal blocks	486
Relays/solid-state relays	320
Cross-reference list	488
<hr/>	
System cables	
With flat-ribbon cable and D-SUB plug-in connectors	500
<hr/>	
Introduction to VARIOFACE wiring interface	520
<hr/>	
Overview of VIP - VARIOFACE Professional	522
<hr/>	
Passive universal interface modules	
VIP modules with flat-ribbon cable plug-in connectors	524
VIP modules with D-SUB plug-in connectors	532
VIP modules with high-density D-SUB plug-in connectors	539
With DIN strips	540
With ELCO plug-in connectors	542
With RJ45 plug-in connectors	546
With COMBICON connection	547
VIP potential distributors	548
<hr/>	
Active interface modules	
For relay couplers/optocouplers	550
For solid-state relays	553
Accessories (relays, optocouplers)	554



A large part of the costs incurred in automation systems today results from the cabling for the actuators and signaling units. On top of this, machines and systems are becoming more and more complex, which means that the cabling costs for the input and output stations are also steadily on the increase. In addition to cabling material costs, the costs associated with planning, assembly, startup, and documentation must also be considered.

VARIOFACE system cabling is a system concept that reduces manufacturing costs through fast, error-free, and uniform wiring of the input and output signals of a PLC.

The system design comprises three components:

- VARIOFACE front adapters
- VARIOFACE system cables
- VARIOFACE termination board

VARIOFACE system cabling is available for controllers from:

- **ABB**
- **Allen-Bradley**
- **Emerson**
- **Honeywell**
- **GE Fanuc**
- **Mitsubishi Electric**
- **OMRON**
- **Schneider Electric**
- **Siemens**
- **Yokogawa**
- **Phoenix Contact**

VIP - VARIOFACE Professional

The new front adapters with encapsulated system cables for the S7 300 and new compact termination boards make the system cabling even more robust. VARIOFACE Professional means:

- New front adapters
- **Optimized housing concept**
- **Power supplied via PCB terminal blocks**
- **Plug-in bridges for electrical isolation**
- **Directly connected system cables with encapsulated plugs**
- New termination boards
- **Space saving**
- **Vibration resistant up to 5g**
- **Optional marking**
- **New housing design**

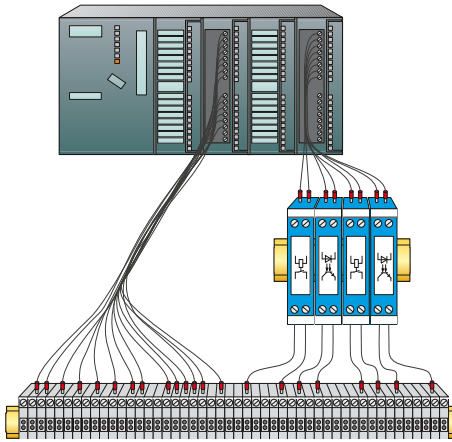

The conventional wiring of input and output cards of programmable logic controls requires a lot of time.

Signals are transferred from the control system to modular terminal blocks or coupling modules such as relays or optocouplers by means of single conductor wiring.

This requires a complex wiring process. At the same time, errors in wiring are always possible with this connection method. Wiring errors are often only noticed when the system is put into operation and they then cause additional costs.

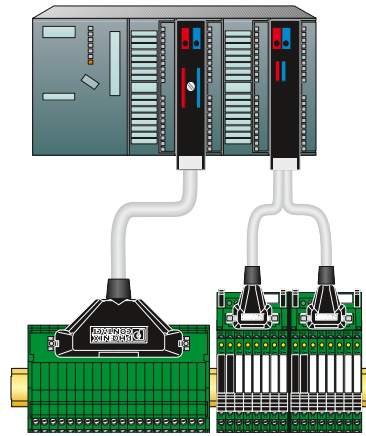

Wiring with the system cabling considerably reduces the assembly time and guarantees protection against polarity reversal.

Front adapters with an integrated pin strip (IEC 60603-13) are plugged onto the PLC I/O cards. They replace connection technologies such as those involving a screw or crimp connection.

The controller boards are simply snapped onto the DIN rail instead of modular terminal blocks or coupling modules. On the control side they also have a multi-position pin strip.

The controller boards are connected to the front adapters using multi-position and pre-assembled system cables.

Actuators and sensors from the field level are connected to the termination boards by means of screw or spring-cage connections or knife disconnect terminal blocks. The termination boards are marked on the field side according to the application, so that the signals can be clearly assigned.



The configuration cross-reference list (a quick reference guide to the VARIOFACE system components) is extremely useful when selecting the required components. What's more, matching components can be configured using the INTERFACE search assistant.

See www.phoenixcontact.net/products.

Rationalize your application with the aid of VARIOFACE system cabling:

- **Easy planning with configuration cross-reference list or online selector**
- **Cost reductions thanks to time-saving wiring**
- **Fault minimization through protection against polarity reversal**
- **Easy maintenance thanks to modular system components**

System cabling for controllers

VARIOFACE system cabling

Product overview of VARIOFACE system cabling

System component		Controller									
		ABB	Allen-Bradley			Emerson	GE FANUC		Honeywell		
		S800 I/O	Control Logix	PLC 5	SLC 500	DeltaV	RX3i	90-30	C300 CI/O, ML 200 series	PlantScape	
Version		Page	Page	Page	Page	Page	Page	Page	Page	Page	
Front adapters		Not required	424	426	428	Not required	436	437	438	424	
System cables	 Standard	512	504	504	504	506	504	504	512	504	
	 Controller-specific	423			430	432			441		
Termination boards	 Passive Standard	470	470	470	470	470	470	470	439	470	
	 Passive Controller-specific	422	473		429	433					
	 Active Standard	490	490	490	490	490	490	490	490	490	
	 V8 adapter/ feed-through terminal block	484	484	484	484	484	484	484	484	484	
	 Relay/ optocoupler	320	320	320	320	320	320	320	320	320	
	 MINI Analog system adapter										
	 MINI Analog										

	Mitsubishi	OMRON CJ1	Phoenix Contact	Schneider		Siemens				Yokogawa
	MELSEC A, A1S, Q, L	CS1, CQM1, C200H	Axioline Inline	TSX Qantum	M340	S7 300	S7 1500	S7 400	S5 to S7 conversion	Centum CS3000
	Page	Page	Page	Page	Page	Page	Page	Page	Page	Page
	Not required	Not required	444	445	446	448	Not required	458	459	Not required
			504	504	504	504		504		
	440	442			447	453	456			466
	470	470	470	470	470	470	470	470		
				473		472		472		468
	490	490	490	490	490	490	490	490		
	484	484	484	484	484	484	484	484		484
	320	320	320	320	320	320	320	320		320
						94				94
						92				92

System cabling for controllers

VARIOFACE system cabling

ABB S800 I/O Termination boards with knife disconnection

The ABB S800 I/O system offers the possibility of realizing the process wiring with D-SUB plug-in connectors. ABB TU 812 Compact MTU are available for this purpose.

The FLKM-D25SUB/B/KDS3-MT/... modules are connected to the I/O modules using assembled D-SUB cables (refer to "System cables" chapter).

In addition to screw connection with knife disconnection for every channel and ABB S800-specific labeling, the modules have the following features:

- Eight negative terminals with knife disconnection (TU810)
- Eight positive terminals with knife disconnection (TU810/P)
- For each channel, there is a positive and negative terminal with knife disconnection (TU830)

Passive interface modules can also be used for signal transmission (e.g., VIP-3/SC/D25SUB/F, 2315188), see page 533.

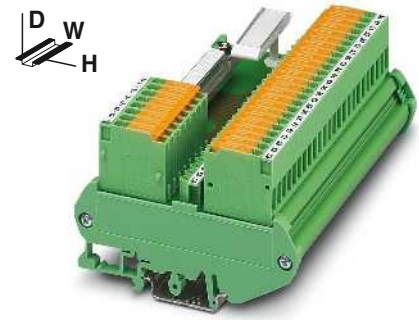

Interface module with knife disconnect terminal blocks

Connectable I/O modules

Card type	FLKM-D25SUB...
Digital input	DI 810
	DI 811
	DI 814
	DI 830
	DI 831
	DI 885
Digital output	DO 810
	DO 814
Analog input	AI 810
	AI 820
	AI 830
	AI 835
Analog output	AO 810
	AO 820

Max. perm. operating voltage	50 V AC/DC
Max. perm. current (per branch)	2 A
Max total current (voltage supply)	4 A (8 A L1-/L2-)
Rated surge voltage	1.4 kV
Ambient temperature (operation)	-20°C ... 50°C
Mounting position	Any
Standards/regulations	DIN EN 50178, IEC 62103
Connection method	Field level Screw connection with disconnect knife
	Control system level
Connection data solid / stranded / AWG	D-SUB socket strip 0.2 ... 4 mm ² / 0.2 ... 2.5 mm ² / 24 - 12
Dimensions	90 mm / 61 mm H / D

Technical data

Max. perm. operating voltage	50 V AC/DC
Max. perm. current (per branch)	2 A
Max total current (voltage supply)	4 A (8 A L1-/L2-)
Rated surge voltage	1.4 kV
Ambient temperature (operation)	-20°C ... 50°C
Mounting position	Any
Standards/regulations	DIN EN 50178, IEC 62103
Connection method	Field level Screw connection with disconnect knife
	Control system level
Connection data solid / stranded / AWG	D-SUB socket strip 0.2 ... 4 mm ² / 0.2 ... 2.5 mm ² / 24 - 12
Dimensions	90 mm / 61 mm H / D

Ordering data

Type	Order No.	Pcs. / Pkt.
FLKM-D25 SUB/B/KDS3-MT/TU810	2304513	1
FLKM-D25 SUB/B/KDS3-MT/TU810/P	2304539	1
FLKM-D25 SUB/B/KDS3-MT/TU830	2304526	1

Description	No. of pos.	Module width W
VARIOFACE module, with knife disconnect terminal blocks for:		
- S800 I/O output modules	25	126.5 mm
- S800 I/O input modules	25	126.5 mm
- S800 I/O universal module	25	247.5 mm

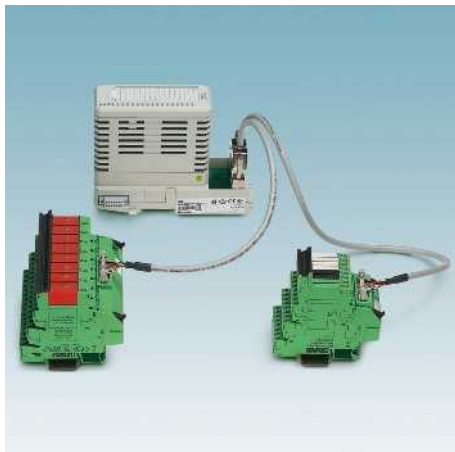

Explanation:

- Flat-ribbon cable strip
- Connection to I/O card
- Screw terminal blocks for separate supply

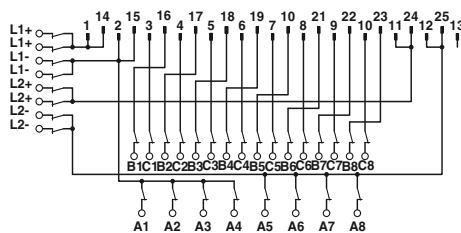

FLKM-D25 SUB/B/KDS3-MT/TU810 connection scheme

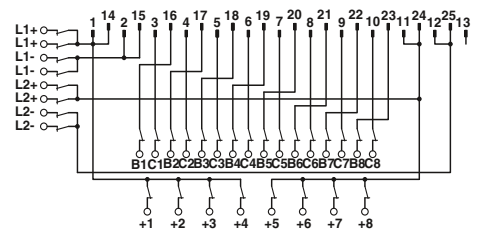

FLKM-D25 SUB/B/KDS3-MT/TU810/P connection scheme

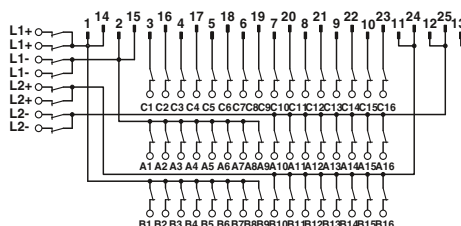

FLKM-D25 SUB/B/KDS3-MT/TU830 connection scheme

ABB S800 I/O System cable

The ABB S800 I/O system offers the possibility of realizing the process wiring with D-SUB plug-in connectors. ABB TU 812 Compact MTU are available for this purpose.

The CABLE-D25SUB/B/2X14/.../TU812 system cables convert from a D-SUB socket strip to two flat-ribbon cable plugs. Therefore, all 8-channel controller boards of the system cabling can be connected to S800 I/O modules. Two controller boards are used per module.



System cable

Color code and pin assignment CABLE-D25SUB/B/2X14...TU812

D-SUB connector 25-pos.	FLK 14 1. Connector	FLK 14 2. Connector	Conductor color
1	9		Gray
2	10		White
3	1		Black
4	3		Red
5	5		Yellow
6	7		Blue
7		1	Black
8		3	Red
9		5	Yellow
10		7	Blue
11		9	Orange
12		10	White
13	NC	NC	-
14	11		White-black
15	12		White-brown
16	2		Brown
17	4		Orange
18	6		Green
19	8		Violet
20		2	Brown
21		4	Orange
22		6	Green
23		8	Violet
24		11	White-black
25		12	White-brown

Max. perm. operating voltage
Max. perm. current carrying capacity per path
Ambient temperature (operation)
Assembly

Conductor cross section
Conductor structure: stranded wires / material
Outside diameter

25 -position

Technical data

< 50 V AC / 60 V DC
1 A
-20°C ... 50°C
Insulation displacement, IEC 60352-4/DIN EN 60352-4

AWG - / 0.14 mm²
7 / Cu tin-plated

6.3 mm

Ordering data

Description

No. of
pos.

Cable length

VARIOFACE system cable, for S800 I/O, with a 25-pos. D-SUB socket strip and two 14-pos. flat-ribbon cable plugs, in standard lengths

25
25
25
25
25

1 m
2 m
3 m
5 m

VARIOFACE system cable for S800 I/O, with a 25-pos. D-SUB socket strip and two 14-pos. flat-ribbon cable plugs, in variable lengths

25

Type	Order No.	Pcs. / Pkt.
CABLE-D25SUB/B/2X14/100/TU812	2304649	1
CABLE-D25SUB/B/2X14/200/TU812	2304652	1
CABLE-D25SUB/B/2X14/300/TU812	2304665	1
CABLE-D25SUB/B/2X14/500/TU812	2304678	1
CABLE-D25SUB/B/2X14/TU812/...	2304681	1

Ordering example for system cable:

- Cable for ABB S800, 12.75 m long

Quantity	Order No.	Length [m] ¹⁾
1	2304681	12.75

¹⁾ min. 0.20 m

System cabling for controllers

VARIOFACE system cabling

Allen-Bradley ControlLogix, Honeywell PlantScape Front adapter

I/O modules with 32 channels or with this design

The front adapters are pushed into the tall 1756-TBE covers (not supplied as standard, original accessories must be ordered directly from manufacturer) of the controller. A 50-pos. system cable can connect a maximum of 32 channels to the field level.

Perfectly-fitting VARIOFACE termination boards round off this system concept.

Notes:
Front adapters can also be used without cover.
Suitable system cabling components can be configured in the INTERFACE search wizard. See www.phoenixcontact.net/products



32-channel front adapter with 50-pos. FLK strip



Technical data

Max. perm. operating voltage
Max. permissible current

< 50 V AC / 60 V DC
1 A (per path)
8 A (per connection, supply via separate power supply)

Ambient temperature (operation)
Ambient temperature (storage/transport)
Connection data solid / stranded / AWG
Standards/regulations

-20°C ... 50°C
-20°C ... 70°C
0.14 ... 1.5 mm² / 0.14 ... 1.5 mm² / 28 - 16
IEC 60664 / IEC 60664 / IEC 60664

Ordering data

Description	No. of pos.
VARIOFACE front adapters, for ControlLogix:	
- A maximum of 1 x 32 channels can be connected	50
- IB 32 input board	50

Type	Order No.	Pcs. / Pkt.
FLKM 50-PA-AB/1756/EXTC	2302735	1
FLKM 50-PA-AB/1756/IN/EXTC	2302748	1

Front adapters for I/O modules of Allen-Bradley ControlLogix and Honeywell PlantScape automation devices

Card type	FLKM 50-PA-AB/1756/EXTC
Digital input	1756-IA 16 I* or TC-TDK 161* 1756-IB 16 D* or TC-TDX 161* 1756-IB 16 I* or TC-TDJ 161* 1756-IH 16 I*
Digital output	1756-OB 32 or TC-ODD 321
Analog input	1756-IF 8* 1756-IF 16 I* or TC-IAH 161* 1756-IF 8H* or TC-HAI 081*
Counter	1756-HSC*
Servo	1756-M02 AE*
Card type	FLKM 50-PA-AB/1756/IN/EXTC
Digital input	1756-IB 32 or TC-IDD 321

* Only in conjunction with VIP-2/SC/FLK50/AB-1756, Order No. 2322317. There must be no voltage supply at the front adapter. Risk of short circuit!

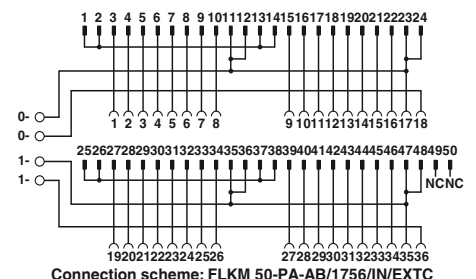
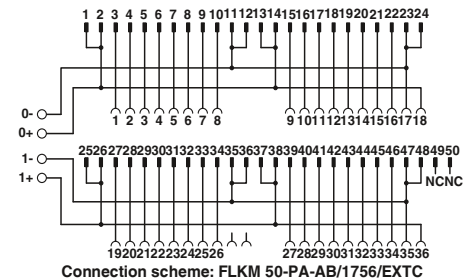

Explanation:

- Flat-ribbon cable strip
- Connection to I/O card
- Screw terminal blocks for separate supply

Allen-Bradley ControlLogix, Honeywell PlantScope Front adapter

I/O modules with 16 channels or with this design

The front adapters are pushed into the tall 1756-TBE covers (not supplied as standard, original accessories must be ordered directly from manufacturer) of the controller. Two 14-pos. system cables are used to connect up to 2 x 8 channels to the field level.

Perfectly-fitting VARIOFACE termination boards round off this system concept.

Notes:

Front adapters can also be used without cover.

Suitable system cabling components can be configured in the INTERFACE search wizard. See www.phoenixcontact.net/products



16-channel front adapter with two 14-pos. FLK strips



Technical data

Max. perm. operating voltage
Max. permissible current

< 50 V AC / 60 V DC
1 A (per path)
8 A (per connection, supply via separate power supply)

Ambient temperature (operation)
Ambient temperature (storage/transport)
Connection data solid / stranded / AWG
Standards/regulations

-20°C ... 50°C
-20°C ... 70°C
0.14 ... 1.5 mm² / 0.14 ... 1.5 mm² / 28 - 16
IEC 60664 / IEC 60664 / IEC 60664

Ordering data

Description	No. of pos.
VARIOFACE front adapters , for ControlLogix:	
- Up to 2 x 8 channels can be connected	14
- IA 16, IB 16, IC 16, IN 16 input card	14
- IF6 I input card (only suitable for measuring current; no power terminals on adapter)	14

Type	Order No.	Pcs. / Pkt.
FLKM 14-PA-AB/1756/EXTC	2302861	1
FLKM 14-PA-AB/1756/IN/EXTC	2302874	1
FLKM 14-PA-AB/1756/IF6I/EXTC	2901037	1

Front adapter for I/O modules of Allen Bradley ControlLogix and Honeywell PlantScope automation devices

Card type	FLKM 14-PA-AB/1756/EXTC
Digital input	1756-IA 8 D** or TC-IDX 081**
Digital output	1756-OB 16 E
Analog input	1756-IF 6 CIS** 1756-IF 6 I** or TC-IAH 061** 1756-IR 6 I** or TC-IXR 061** 1756-IT 6 I** or TC-IXL 061**
Analog output	1756-OF 4 I** 1756-OF 6 CI** or TC-OAH 061** 1756-OF 6 VI** or TC-OAV 061** 1756-OF 8** or TC-OAV 081** 1756-OF 8 H**
Switch	1756-PLS**

Card type	FLKM 14-PA-AB/1756/IN/EXTC
Digital input	1756-IN 16** 1756-IA 16 or TC-IDA 161** 1756-IB 16 1756-IC 16**

Card type	FLKM 14-PA-AB/1756/IF6I/EXTC
Analog input	IF6I**

** Only in conjunction with VIP-2/SC/2FLK14/AB-1756, Order No.: 2322333. There must be no voltage supply at the front adapter. Risk of short circuit!!!

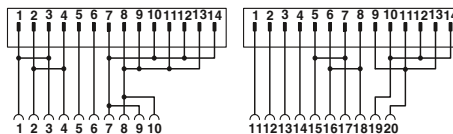

Connection scheme: FLKM 14-PA-AB/1756/IF6I/EXTC

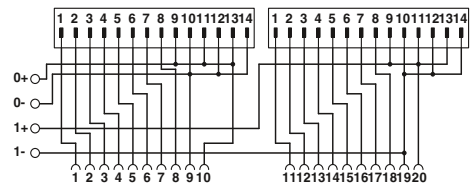

Connection scheme: FLKM 14-PA-AB/1756/EXTC

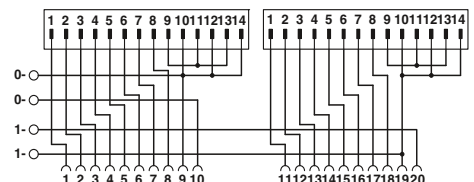

Connection scheme: FLKM 14-PA-AB/1756/IN/EXTC

Explanation:

- Flat-ribbon cable strip
- Connection to I/O card
- Screw terminal blocks for separate supply

System cabling for controllers

VARIOFACE system cabling

Allen-Bradley, PLC 5 series 1771 Front adapter

The front adapters mean that pre-assembled system cables can be directly connected to I/O modules.

Up to 32 channels are connected via 50-pos. system cables.

Perfectly-fitting VARIOFACE termination boards with a variety of functions and connection possibilities round off this system concept.

Notes:

Suitable system cabling components can be configured in the INTERFACE search wizard. See www.phoenixcontact.net/products



Front adapter for Allen-Bradley PLC 5, 1771



Technical data

Max. perm. operating voltage	< 50 V AC / 60 V DC
Max. permissible current	1 A (per path)
Max. perm. total current	2 A (Per Byte, for supply via connector)
Ambient temperature (operation)	-20°C ... 50°C
Ambient temperature (storage/transport)	-20°C ... 70°C
Standards/regulations	IEC 60664 / IEC 60664 / IEC 60664

Ordering data

Description	No. of pos.
VARIOFACE front adapters, for Allen-Bradley PLC 5, 1771	
- IBN 32 channels input	50
- OBN 32 channels output	50

Type	Order No.	Pcs. / Pkt.
FLKM 50-PA-AB/IBN	2289816	2
FLKM 50-PA-AB/OBN	2289829	2

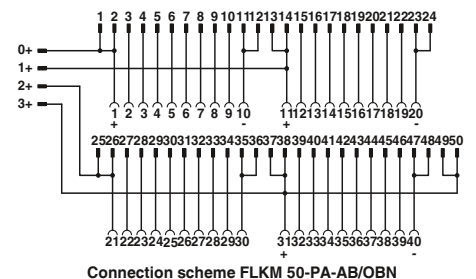
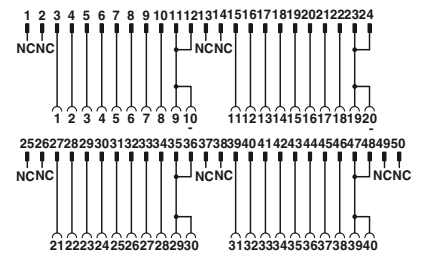

Explanation:

- Flat-ribbon cable strip
- Connection to I/O card
- Screw terminal blocks for separate supply

VARIOFACE system cabling

Allen-Bradley SLC 500 Front adapter

The front adapters mean that pre-assembled system cables can be directly connected to I/O modules.

- The FLKM 14-PA-SLC500... adapters connect max. 2 x 8 channels via two 14-pos. system cables. Perfectly-fitting VARIOFACE termination boards with a variety of functions and connection possibilities round off this system concept.
- With the FLKM50-PA-SLC500 OUT/2A front adapters, the FLKM 50/16/SLC500 termination board and 50-pos. system cables, the VARIOFACE system cabling can also be coupled to the OA16 and OW16 power output cards.

Notes:

Suitable system cabling components can be configured in the INTERFACE search wizard. See www.phoenixcontact.net/products



Front adapter for SLC 500 1746, 2 x 8 channels can be connected

Max. perm. operating voltage
Max. permissible current
Max. perm. total current

Ambient temperature (operation)
Ambient temperature (storage/transport)
Mounting position
Standards/regulations



Technical data

FLKM 14-PA...	FLKM 50-PA...
< 50 V AC / 60 V DC	< 50 V AC / 60 V DC
1 A (per path)	2 A (per path)
2 A (Per Byte, for supply via connector)	7 A (Per Byte, for supply via connector)
-20°C ... 50°C	-20°C ... 50°C
-20°C ... 70°C	-20°C ... 70°C
Any	Any
IEC 60664 / IEC 60664 / IEC 60664	IEC 60664 / IEC 60664 / IEC 60664

Ordering data

Description	No. of pos.
VARIOFACE front adapter , 2 x 8 channels can be connected for Allen-Bradley SLC 500 for:	
- 1746 OB16, OV16, OG16 and IG16	14
- 1746 IA16, IB16, ITB16 and IN16	14
- 1746 IV16 and IVT16	14
VARIOFACE front adapter , 1 x 16 channels can be connected for Allen-Bradley SLC 500 1746 OA16 and OW16	50

Type	Order No.	Pcs. / Pkt.
FLKM 14-PA-SLC500/OUT	2293459	1
FLKM 14-PA-SLC500/IN	2293462	1
FLKM 14-PA-SLC500/IN/M	2293475	1
FLKM 50-PA-SLC500/OUT/2A	2293446	1

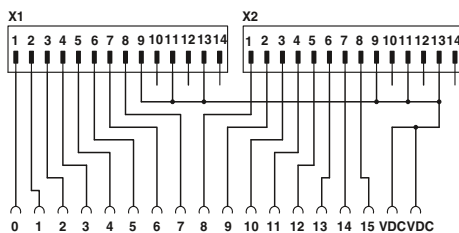

Connection scheme FLKM 14-PA-SLC500/IN/M

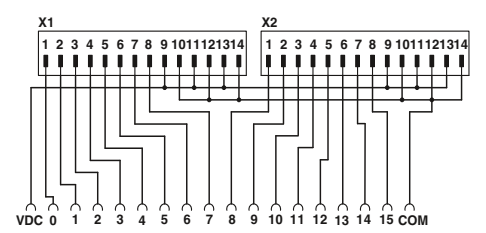

Connection scheme FLKM 14-PA-SLC500/OUT

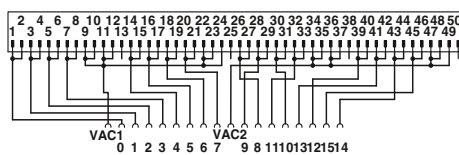

Connection scheme FLKM 50-PA-SLC500/OUT/2A

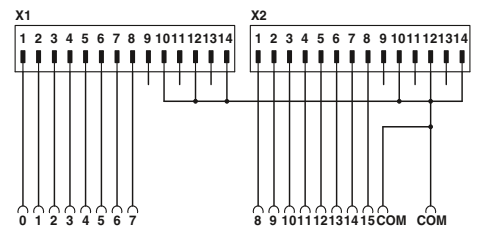

Connection scheme FLKM 14-PA-SLC500/IN

Explanation:

- Flat-ribbon cable strip
- Connection to I/O card
- Screw terminal blocks for separate supply

VIP termination board for Allen-Bradley SLC 500, 2 A output cards

The VIP-2/.../FLK50/16/SLC500 VARIOFACE Professional (VIP) module has been designed specifically for OA16 and OW16 output modules. When used in conjunction with the FLKM 50-PA-SLC500/OUT/2A front adapter, currents up to 2 A per channel can be transferred with the system cabling.

Notes:
For marking systems (e.g., "ZB 22:UNBEDRUCKT"; Order No. 0811862) and mounting material, see Catalog 5.

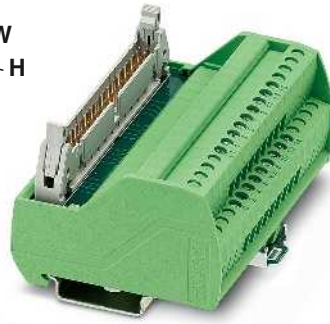

VARIOFACE termination board for 16 channels with screw connection

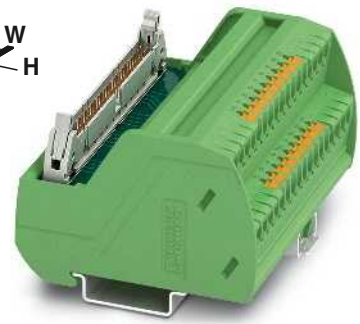

VARIOFACE termination board for 16 channels with push-in connection



Max. perm. operating voltage	120 V AC/DC
Max. perm. current (per branch)	1 A
Max total current (voltage supply)	2 A (per channel)
Ambient temperature (operation)	-20°C ... 50°C
Mounting position	Any
Standards/regulations	IEC 60664, DIN EN 50178, IEC 62103
Connection method	Screw connection
	Field level
	Control system level
Connection data solid / stranded / AWG	IDC/FLK pin strip (2.54 mm) 0.2 ... 4 mm ² / 0.2 ... 2.5 mm ² / 24 - 12
Dimensions	65.5 mm / 56 mm

Technical data

Max. perm. operating voltage	120 V AC/DC
Max. perm. current (per branch)	1 A
Max total current (voltage supply)	2 A (per channel)
Ambient temperature (operation)	-20°C ... 50°C
Mounting position	Any
Standards/regulations	IEC 60664, DIN EN 50178, IEC 62103
Connection method	Push-in connection
	Field level
	Control system level
Connection data solid / stranded / AWG	IDC/FLK pin strip (2.54 mm) 0.14 ... 2.5 mm ² / 0.14 ... 2.5 mm ² / 26 - 14
Dimensions	72.1 mm / 56 mm

Technical data

Max. perm. operating voltage	120 V AC/DC
Max. perm. current (per branch)	1 A
Max total current (voltage supply)	2 A (per channel)
Ambient temperature (operation)	-20°C ... 50°C
Mounting position	Any
Standards/regulations	IEC 60664, DIN EN 50178, IEC 62103
Connection method	Push-in connection
	Field level
	Control system level
Connection data solid / stranded / AWG	IDC/FLK pin strip (2.54 mm) 0.14 ... 2.5 mm ² / 0.14 ... 2.5 mm ² / 26 - 14
Dimensions	72.1 mm / 56 mm

Ordering data

Type	Order No.	Pcs. / Pkt.
VIP-2/SC/FLK50/16/SLC500	2322320	1

Ordering data

Type	Order No.	Pcs. / Pkt.
VIP-2/PT/FLK50/16/SLC500	2904287	1

Description	No. of pos.	Module width W
VARIOFACE controller board , for transfer of max. 16 channels, only in connection with FLKM 50-PA-SLC500 OUT/2A		
- with screw connection		90.8 mm
- with push-in connection	50	92.7 mm

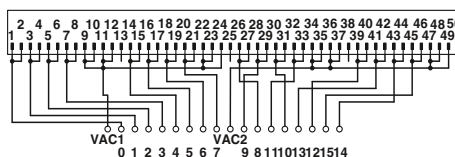

Connection scheme VIP-2/.../FLK50/16/SLC500

System cabling for controllers

VARIOFACE system cabling

Allen-Bradley SLC 500 System cable for 32 channels

The 32-channel I/O cards of the SLC 500 are connected using 40-pos. plug-in connectors (already integrated into the I/O modules). Passive interface modules (-3/SC/FLK40, etc.) are connected to the I/O cards using the **FLK 40/EZ-DR/.../SLC** system cables.

32 channels are split into 4x8 channels using the **FLK 40/4X14/EZ-DR/...** system cables.

The following 8-channel system cabling modules can be coupled:

- OB32 and IB32
passive and active modules plus V8 adapter
- OV32 and IV32
passive modules without status indicator

Notes:
Suitable system cabling components can be configured in the INTERFACE search wizard. See www.phoenixcontact.net/products



**System cable for
32-channel I/O cards of the SLC 500
(OB32, OV32, IB32, IV32)**



Max. perm. operating voltage
Max. perm. current carrying capacity per path
Ambient temperature (operation)
Assembly

Conductor cross section
Conductor structure: stranded wires / material
Outside diameter

Technical data	
< 50 V AC / 60 V DC	
1 A	
-20°C ... 50°C	
Insulation displacement, IEC 60352-4/DIN EN 60352-4	
AWG 26 / 0.14 mm ²	
7 / Cu tin-plated	
40 -position	10 mm

Description	No. of pos.	Cable length
Assembled round cables , with two 40-pos. socket strips in fixed lengths (50 cm steps) for connection with 32-channel I/O cards of the SLC 500		
	40	0.5 m
	40	1 m
	40	1.5 m
	40	2 m
	40	3 m
Round cable sets , for connection to Allen-Bradley SLC500, OB32 and IB32, with one 40-pos. socket strip and four 14-pos. socket strips, for splitting max. 32 channels into 4 x 8 channels.		
for OB32	40	0.5 m
	40	1 m
	40	2 m
	40	3 m
for IB32	40	0.5 m
	40	1 m
	40	2 m
	40	3 m

Ordering data		
Type	Order No.	Pcs. / Pkt.
FLK 40/EZ-DR/ 50/SLC	2294610	1
FLK 40/EZ-DR/ 100/SLC	2294623	1
FLK 40/EZ-DR/ 150/SLC	2294636	1
FLK 40/EZ-DR/ 200/SLC	2294649	1
FLK 40/EZ-DR/ 300/SLC	2294652	1



**System cable for
splitting max. 32 channels into 4 x 8 channels
(OB32, IB32)**



Technical data

< 50 V AC / 60 V DC

1 A

-20°C ... 50°C

Insulation displacement, IEC 60352-4/DIN EN 60352-4

AWG 26 / 0.14 mm²

7 / Cu tin-plated

7.8 mm

Ordering data

Type	Order No.	Pcs. / Pkt.
...		
FLK 40/4X14/EZ-DR/ 50/OB32	2296786	1
FLK 40/4X14/EZ-DR/ 100/OB32	2298483	1
FLK 40/4X14/EZ-DR/ 200/OB32	2298522	1
FLK 40/4X14/EZ-DR/ 300/OB32	2298535	1
FLK 40/4X14/EZ-DR/ 50/IB32	2296812	1
FLK 40/4X14/EZ-DR/ 100/IB32	2296825	1
FLK 40/4X14/EZ-DR/ 200/IB32	2296838	1
FLK 40/4X14/EZ-DR/ 300/IB32	2296841	1

VARIOFACE system cabling

Emerson DeltaV System cable

The DeltaV system allows you to install the process wiring through “Mass termination blocks” (MTB) using flat-ribbon cable connectors. Besides the 10-, 16-, and 20-pos. system cables of system cabling (refer to the System cables chapter), the following system-specific lines are also available:

- **FLK 16/14/DV-OUT/...**, for digital assemblies with 16-pos. MTB for connection to PLC-INTERFACE
- **FLK 16/14/DV-IN/...**, for digital assemblies with 16-pos. MTB for connection to PLC-INTERFACE
- **FLK 20/2FLK14/EZ-DR/...**, for digital assemblies with 40-pos. MTB for connection to PLC-INTERFACE
- **FLK 16/24/DV-AI/EZ-DR/...**, for analog assemblies with 24-pos. MTB
- **FLK 50/2FLK20/EZ-DR/.../DV** system cables are specifically designed for 32-channel I/O modules with 40-pin MTB for the purpose of connecting I/O modules to 32-channel VARIOFACE interface modules



System cable for DeltaV

		Technical data	
Max. perm. operating voltage		< 50 V AC / 60 V DC	
Max. perm. current carrying capacity per path		1 A	
Max. conductor resistance		0.16 Ω/m	
Ambient temperature (operation)		-20°C ... 50°C	
Conductor cross section		AWG 26 / 0.14 mm ²	
Outside diameter		16 -position	6.8 mm
		20 -position	7.6 mm
		24 -position	6.5 mm
		20 -position	10.3 mm

Description	No. of pos.	Cable length	Ordering data		
System cable , for 16-pos. "mass termination blocks" with a 16-pos. and a 14-pos. flat-ribbon cable plug for connection with PLC-INTERFACE			Type	Order No.	Pcs. / Pkt.
	16	0.3 m	FLK 16/14/DV-OUT/ 30	2304348	1
	16	0.5 m	FLK 16/14/DV-OUT/ 50	2304351	1
	16	1 m	FLK 16/14/DV-OUT/100	2300575	1
	16	2 m	FLK 16/14/DV-OUT/200	2300588	1
	16	3 m	FLK 16/14/DV-OUT/300	2304364	1
Variable cable length	16		FLK 16-14-DV-OUT/...	2304377	1
System cable , for 16-pos. "mass termination blocks" with a 16-pos. and a 14-pos. flat-ribbon cable plug for connection with PLC-INTERFACE					
	16	0.5 m	FLK 16/14/DV-IN/ 50	2304393	1
	16	1 m	FLK 16/14/DV-IN/100	2300559	1
	16	2 m	FLK 16/14/DV-IN/200	2300562	1
	16	3 m	FLK 16/14/DV-IN/300	2304403	1
	16	4 m	FLK 16/14/DV-IN/400	2305185	1
Variable cable length	16		FLK 16-14-DV-IN/...	2304416	1
System cable , for 40-pos. (2 x 20) "mass termination blocks" with a 20-pos. and two 14-pos. flat-ribbon cable plugs for connection with PLC-INTERFACE (two cables should be used per 32-channel I/O card)					
	20	1 m	FLK 20/2FLK14/EZ-DR/100/KONFEK	2298470	1
	20	2 m	FLK 20/2FLK14/EZ-DR/200/KONFEK	2298438	1
	20	3 m	FLK 20/2FLK14/EZ-DR/300/KONFEK	2300818	1
Variable cable length	20		FLK 20/2FLK14/EZ-DR/...	2304487	1
System cable , for 24-pos. "mass termination blocks" with a 24-pos. and a 16-pos. flat-ribbon cable plug for connection with UM-DELTA/... modules					
	24	0.3 m	FLK 16/24/DV-AI/EZ-DR/ 30	2304319	1
	24	0.5 m	FLK 16/24/DV-AI/EZ-DR/ 50	2304296	1
	24	1 m	FLK 16/24/DV-AI/EZ-DR/100	2301134	1
	24	2 m	FLK 16/24/DV-AI/EZ-DR/200	2301545	1
	24	3 m	FLK 16/24/DV-AI/EZ-DR/300	2304322	1
Variable cable length	24		FLK 16-24-DV-AI-EZ-DR/...	2304335	1
System cable , for 40-pos. "mass termination blocks" with two 20-pos. and one 50-pos. flat-ribbon cable plugs for connecting with 32-channel interface modules					
	20	0.5 m	FLK 50/2FLK20/EZ-DR/ 50/DV	2304872	1
	20	1 m	FLK 50/2FLK20/EZ-DR/ 100/DV	2304898	1
	20	2 m	FLK 50/2FLK20/EZ-DR/ 200/DV	2304908	1
	20	3 m	FLK 50/2FLK20/EZ-DR/ 300/DV	2304911	1
	20	6 m	FLK 50/2FLK20/EZ-DR/ 600/DV	2304937	1
	20	8 m	FLK 50/2FLK20/EZ-DR/ 800/DV	2304940	1
	20	10 m	FLK 50/2FLK20/EZ-DR/1000/DV	2304953	1
Variable cable length	20		FLK 50-2FLK20-EZ-DR-DV/...	2304966	1



**Emerson DeltaV
Controller board for eight channels**

These system-specific interface modules for DeltaV assemblies are used in combination with the respective system cables. The controller board is connected to 8-channel modules through “mass termination blocks” with flat-ribbon cable connection.

FLKM 16/DV

- Universal module
- 1:1 connection

FLKM 16/AI/DV

- 1:1 connection
- Separate equipotential terminals per channel

FLKM 16/AO/SI/DV

- 1:1 connection
- Fuse 5 x 20, 50 mA T, IEC60127-2/3 per channel

FLKM 16/DI/SI/LA/DV

- 1:1 connection
- Fuse 5 x 20, 50 mA T, IEC60127-2/3 per channel
- LED status indicator per signal path

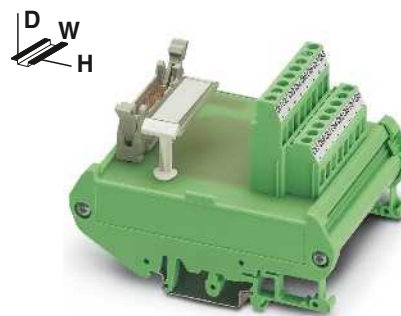

Interface module for 8 channels

Max. perm. operating voltage
Max. perm. current (per branch)

Rated surge voltage
Ambient temperature (operation)
Mounting position
Standards/regulations
Connection method

Field level
Control system level

Connection data solid / stranded / AWG
Dimensions

Technical data	
FLKM 16/.../DV < 50 V AC 1 A (per signal path)	FLKM 16/.../SI/.../DV < 50 V AC 50 mA (In delivered state, with one 50 mA fuse, max. 1 A permitted)
0.8 kV -20°C ... 50°C Any IEC 60664, DIN EN 50178, IEC 62103	0.8 kV -20°C ... 50°C Any IEC 60664, DIN EN 50178, IEC 62103
Screw connection IDC/FLK pin strip (2.54 mm)	Screw connection IDC/FLK pin strip (2.54 mm)
0.2 ... 4 mm ² / 0.2 ... 2.5 mm ² / 24 - 12 90 mm / 68 mm	

Ordering data		
Type	Order No.	Pcs. / Pkt.
FLKM 16/DV	2304432	1
FLKM 16/AI/DV	2304429	1
FLKM 16/AO/SI/DV	2304445	1
FLKM 16/DI/SI/LA/DV	2304458	1

Description	No. of pos.	Module width W
Interface module, with 1:1 connection	16	45 mm
Interface module, with 1:1 connection and separate potential terminal blocks per channel	16	57 mm
Interface module, with fuses per channel	16	90 mm
Interface module, with LED and fuses per channel	16	90 mm

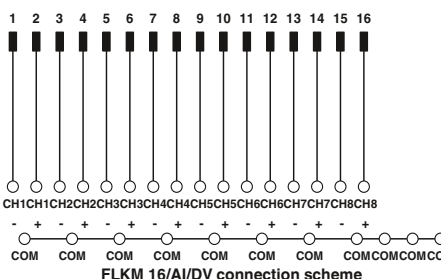
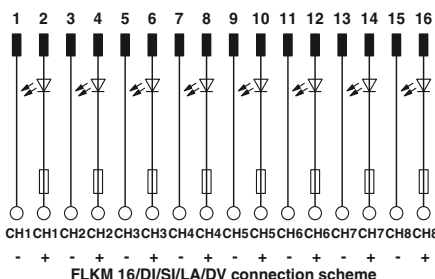
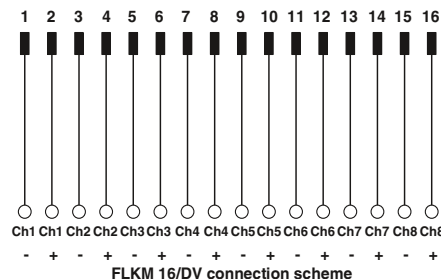
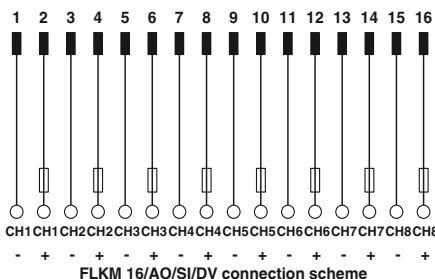

System cabling for controllers

VARIOFACE system cabling

Emerson DeltaV Controller board for 32 channels

These system-specific interface modules for DeltaV assemblies are used in combination with the FLK 50/2FLK20/EZ-DR/.../DV system cables. The controller board is connected to 32-channel modules through 40-pos. "mass termination blocks" with flat-ribbon cable connection.

FLKM 50/32M/DV

- Can be used for 32-channel input and output cards
- Two-conductor connection with a separate negative terminal per channel

FLKM 50/32M/IN/LA/DV

- Can be used for 32-channel input modules
- LED status display per channel
- Two-conductor connection with a separate negative terminal per channel (Dry Contact)

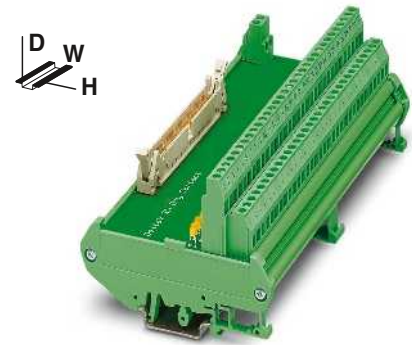

Interface module with two-conductor connection method for DeltaV

Max. perm. operating voltage	
Max. perm. current (per branch)	
Rated surge voltage	
Ambient temperature (operation)	
Mounting position	
Standards/regulations	
Connection method	
	Field level
	Control system level
Connection data solid / stranded / AWG	
Dimensions	H / D

Technical data	
FLKM 50/32M/DV	FLKM 50/32M/IN/LA/DV
< 50 V AC	30 V DC
1 A	1 A
0.8 kV	0.8 kV
-20°C ... 50°C	-20°C ... 50°C
Any	Any
IEC 60664, DIN EN 50178, IEC 62103	
Screw connection	Screw connection
IDC/FLK pin strip (2.54 mm)	IDC/FLK pin strip (2.54 mm)
0.2 ... 4 mm ² / 0.2 ... 2.5 mm ² / 24 - 12	
90 mm / 68 mm	

Description	No. of pos.	Module width W
VARIOFACE interface modules, for 32-channel I/O modules:		
- Input/Output	50	169 mm
- Input with LED per signal	50	169 mm

Ordering data		
Type	Order No.	Pcs. / Pkt.
FLKM 50/32M/DV	2304869	1
FLKM 50/32M/IN/LA/DV	2304856	1

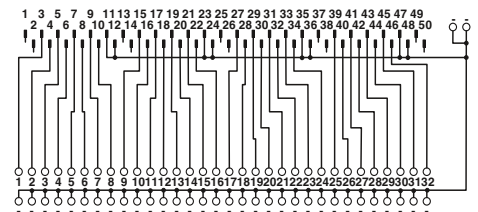

FLKM 50/32M/DV connection scheme

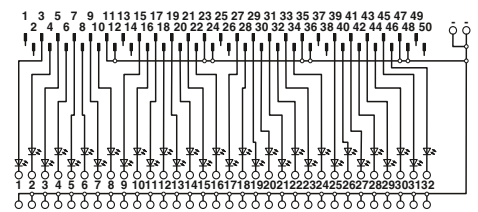

FLKM 50/32M/IN/LA/DV connection scheme

**Emerson DeltaV
Controller boards with fuses for
8 channels**

These system-specific interface modules for DeltaV assemblies are used in combination with the respective system cables. The controller board is connected to 8-channel modules through 16-pos. or 24-pos. "mass termination blocks" with flat-ribbon cable connection.

UM-DELTA V/D/SI

- Fuse per channel
- Separate equipotential terminals per channel

UM-DELTA V/D/SI

- Fuse per channel
- Separate equipotential terminals per channel
- Knife disconnection for each channel

UM-DELTA V/D/SI/BFI/TP

- Fuse and LED status indicator per channel
- Separate equipotential terminals per channel

UM-DELTA V/D/SI

- Fuse and LED status indicator per channel
- Separate equipotential terminals per channel
- Knife disconnection for each channel

Max. perm. operating voltage
Max. perm. current (per branch)

Ambient temperature (operation)
Mounting position
Standards/regulations
Connection method

Connection data solid / stranded / AWG

Dimensions

Field level
Control system level

H / D

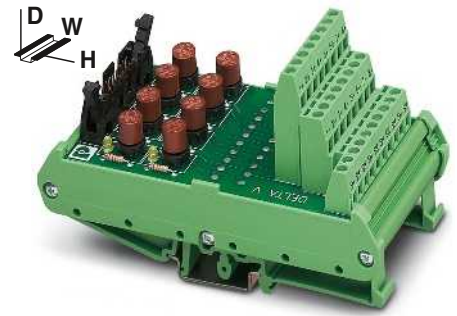

Interface module with fuses for 16-pos. and 24-pos. "mass termination blocks"



Technical data

24 V DC
50 mA
(in as-supplied state, with one 50 mA fuse, max. 1 A permitted)
-20°C ... 50°C
Any
IEC 60664, DIN EN 50178, IEC 62103
Screw connection
IDC/FLK pin strip (2.54 mm)
0.2 ... 4 mm² / 0.2 ... 2.5 mm² / 24 - 12
126 mm / 71 mm

Ordering data

Description	No. of pos.	Module width W
Interface modules for 16-pos. and 24-pos. "mass termination blocks" with:		
- Fuses	16	61 mm
- Fuses and knife disconnect terminal blocks	16	61 mm
- Fuses and fuse failure display	16	61 mm
- Fuses, fuse failure display, and knife disconnect terminal blocks	16	61 mm

Type	Order No.	Pcs. / Pkt.
UM-DELTA V/D/SI	5603255	1
UM-DELTA V/D/SI/BFI/TP	5603257	1
UM-DELTA V/A/SI	5603256	1
UM-DELTA V/A/SI/BFI/TP	5603258	1

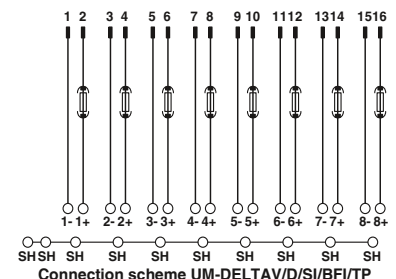
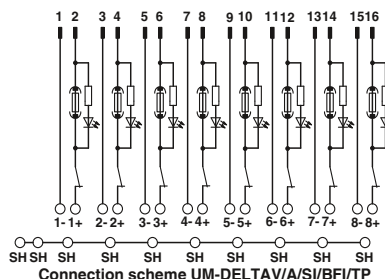
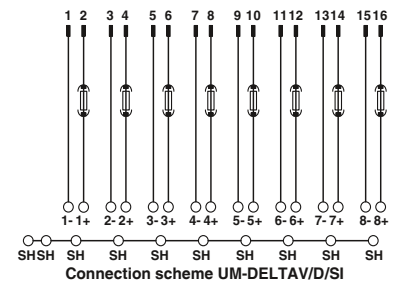
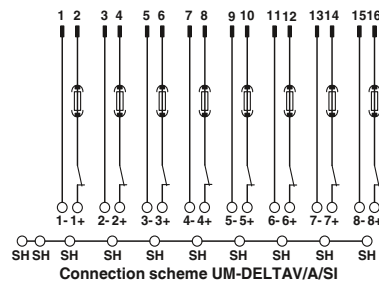

Explanation:

- Flat-ribbon cable strip
- Connection to I/O card
- Screw terminal blocks for separate supply

GE Fanuc/RX3i Front adapters

The front adapters mean that pre-assembled system cables can be directly connected to I/O modules.

- Transfer of max. 32 channels over one 50-pos. system cable
- Can be plugged onto I/O modules
- Connection via suitable VARIOFACE termination boards

Notes:

Suitable system cabling components can be configured in the INTERFACE search wizard. See www.phoenixcontact.net/products



Front adapter for GE Fanuc
RX3i

Technical data

Max. perm. operating voltage	< 50 V AC / 60 V DC
Max. permissible current	1 A (per path) 8 A (per connection, supply via separate power supply)
Ambient temperature (operation)	-20°C ... 50°C
Ambient temperature (storage/transport)	-20°C ... 70°C
Mounting position	Any
Standards/regulations	DIN EN 50178 / DIN EN 50178 / DIN EN 50178

Ordering data

Description	No. of pos.	Type	Order No.	Pcs. / Pkt.
VARIOFACE front adapter, for PACSystems RX3i,				
For digital output and analog modules	50	FLKM 50-PA-GE/TKFC/RXI	2321473	1
For digital input modules	50	FLKM 50-PA-GE/TKFC/RXI/IN	2321486	1

Front adapter for I/O modules of RX3i series

Card type	FLKM 50-PA/GE/TKFC/RXI
Digital output	IC 694 MDL 754
Analog	IC 695 ALG 608* IC 695 ALG 616* IC 695 ALG 626* IC 695 ALG 629* IC 695 ALG 704* IC 695 ALG 708* IC 695 ALG 728*

Card type	FLKM 50-PA/GE/TKFC/RXI/IN
Digital input	IC 694 MDL 660

* Only in connection with VIP-3/SC/FLK50, Order No. 2315081. No voltage may be supplied through the slip-on connections on the front adapter.

Explanation:

- Flat-ribbon cable strip
- Connection to I/O card
- Screw terminal blocks for separate supply

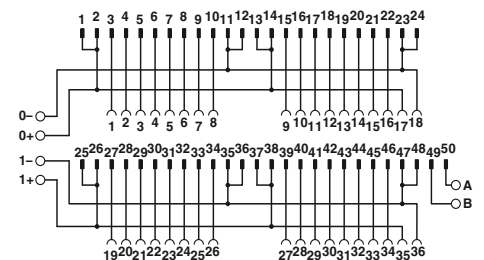

Connection scheme for FLKM 50-PA-GE/TKFC/RXI

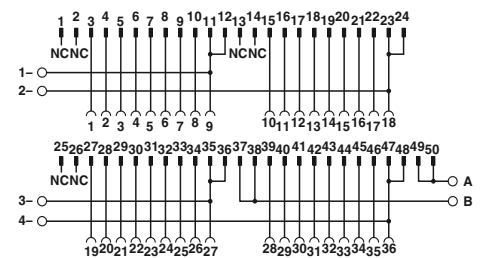

Connection scheme for FLKM 50-PA-GE/TKFC/RXI/IN

GE-FANUC, series 90-30 Front adapter

The front adapters mean that pre-assembled system cables can be directly connected to I/O modules.

Up to 2 x 8 channels are connected via two 14-pos. system cables.

Perfectly-fitting VARIOFACE termination boards with a variety of functions and connection possibilities round off this system concept.

Notes:

Suitable system cabling components can be configured in the INTERFACE search wizard. See www.phoenixcontact.net/products



Front adapter for GE-FANUC series 90-30



Technical data

Max. perm. operating voltage
Max. permissible current

< 50 V AC / 60 V DC
1 A (per path)
4 A (per connection, supply via separate power supply)

Max. perm. total current

3 A (Per Byte, for supply via connector)

Ambient temperature (operation)
Ambient temperature (storage/transport)
Mounting position
Standards/regulations

-20°C ... 50°C
-20°C ... 70°C
Any
IEC 60664 / IEC 60664 / IEC 60664

Ordering data

Description	No. of pos.
VARIOFACE front adapter , for 90-30 series, max. 2 x 8 channels can be connected, digital output	14
VARIOFACE front adapter , for 90-30 series, max. 2 x 8 channels can be connected, digital input	14

Type	Order No.	Pcs. / Pkt.
FLKM 14-PA/GE/DO	2290009	2
FLKM 14-PA/GE/DI	2290038	5

Front adapter for 90-30 series I/O modules

Card type	FLKM 14-PA/GE/DO
Digital output	IC 693 MDL 732 IC 693 MDL 733* IC 693 MDL 740 IC 693 MDL 741* IC 693 MDL 742
Analog	IC 693 ALG 220* IC 693 ALG 221* IC 693 ALG 222* IC 693 ALG 223* IC 693 ALG 390* IC 693 ALG 391* IC 693 ALG 392* IC 693 ALG 442*

Card type	FLKM 14-PA/GE/DI
Digital input	IC 693 MDL 241 IC 693 MDL 634 IC 693 MDL 645 IC 693 MDL 646

* Only in conjunction with VIP-2/SC/2FLK14(1-20)/S7, Order No.: 2315230 and UM 45-2FLK14/ZFKDS/S7, Order No.: 2965156. All wire bridges (DR) on the adapter must be disconnected. There must be no voltage supply at the front adapter (flowing via the slip-on connections)!

Explanation:

- Flat-ribbon cable strip
- Connection to I/O card
- Screw terminal blocks for separate supply

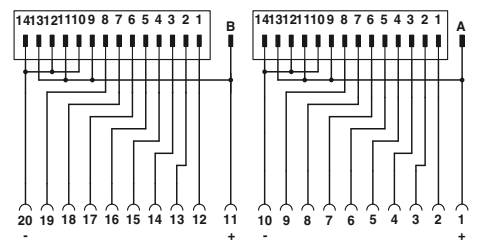

Connection scheme FLKM 14-PA/GE/DO

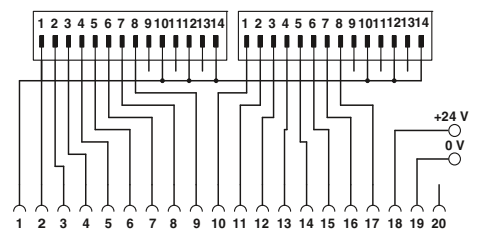

Connection scheme FLKM 14-PA/GE/DI

System cabling for controllers

VARIOFACE system cabling

Honeywell C300, Series C I/O Front adapters

The front adapters mean that pre-assembled system cables can be directly connected to I/O modules.

FLKM-PA-D37/HW/DIO/C300

- Front adapter with D-SUB plug-in connector
- Connection of a maximum of 16 digital channels
- Specifically for digital I/O cards

FLKM-PA-D37/HW/AN/C300

- Front adapter with D-SUB plug-in connector
- Connection of analog modules

FLKM-PA-2D15/HW/.../C300

- Front adapter with two 15-pos. D-SUB plug-in connectors
- Connection of a maximum of 2 x 8 digital inputs/outputs per adapter
- Specifically for connecting PLC-V8/D15.../OUT or PLC-V8/D15.../IN

Notes:

For matching system cable fitted with D-SUB socket strip at both ends, see page 513



Honeywell C300 front adapter

Technical data

24 V DC
1 A (per path)
-20°C ... 50°C
-20°C ... 70°C
Any
DIN EN 50178 / DIN EN 50178

Ordering data

Type	Order No.	Pcs. / Pkt.
FLKM-PA-D37/HW/DIO/C300	2901423	1
FLKM-PA-D37/HW/AN/C300	2900622	1
FLKM-PA-2D15/HW/DO/C300	2900924	1
FLKM-PA-2D15/HW/DI/C300	2901879	1

Description	No. of pos.
VARIOFACE front adapter for C I/O series, with one D-SUB pin strip	
- For digital I/O modules	37
- For analog I/O modules	37
VARIOFACE front adapter for C I/O series, with two D-SUB pin strips	
- For digital output modules	15
- For digital input modules	15

Front adapters for I/O modules of the C300 series, C I/O series

Card type	FLKM-PA-D37/HW/DIO/C300
Digital input	TDIL 11* TDIL 01*
Digital output	TDOB 11* TDOB 01*

Card type	FLKM-PA-D37/HW/AN/C300
Analog input	TAIX 01** TAIX 11**
Analog output	TAOX 01** TAOX 11**

Card type	FLKM-PA-2D15/HW/DO/C300
Digital output	TDOB 01* TDOB 11*

Card type	FLKM-PA-2D15/HW/DI/C300
Digital input	TDIL 01* TDIL 11*

* Two front adapters are required for each module.

** For three-conductor operation (channels 13 - 16) of input modules: only in conjunction with VIP-3/SC/D37SUB/M/HW/C300, Order No. 2900675.

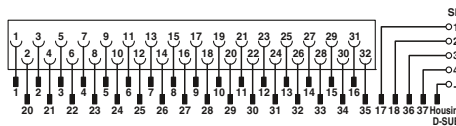

Connection scheme: FLKM-PA-D37/HW/AN/C300

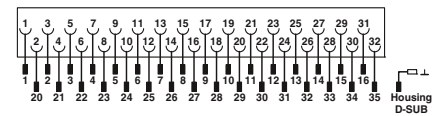

Connection scheme: FLKM-PA-D37/HW/DIO/C300

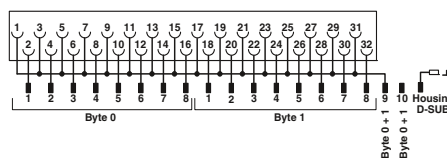

FLKM-PA-2D15/HW/DI/C300 connection scheme

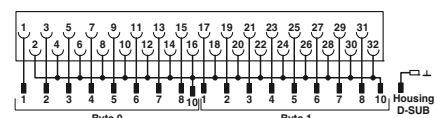

Connection scheme: FLKM-PA-2D15/HW/DO/C300

Explanation:

- Plug-in connector
- Connection to I/O card
- Screw terminal blocks for separate supply

Honeywell C300, Series C I/O interface modules

These VARIOFACE modules are used in combination with 37-pos. D-SUB cables and the relevant front adapters. The three module versions are available with screw or push-in connection technology.

VIP-2/.../D37SUB/M

- In conjunction with FLKM-PA-D37/HW/C300 or FLKM-PA-D37/HW/AN/C300 front adapter
- Universal module
- Field connection via double-level terminal blocks

VIP-2/.../D37SUB/M/SO

- In conjunction with FLKM-PA-D37/HW/C300 front adapter
- System-specific labeling
- Field connection via double-level terminal blocks

VIP-3/.../D37SUB/M/HW/C300

- In conjunction with FLKM-PA- D37/HW/AN/C300 front adapter
- System-specific labeling
- For TAIX01, TAIX11 analog input modules
- Field connection via three-level terminal blocks

Notes:

For marking systems (e.g., "ZB 22:UNBEDRUCKT"; Order No., 0811862) and mounting material, see Catalog 5.



37-pos. with screw or push-in connection



Technical data

VIP-2/...	VIP-3/...C300
125 V AC/DC	125 V AC/DC
2 A	2 A
-20°C ... 50°C	-20°C ... 50°C
Any	Any
DIN EN 50178,	
D-SUB pin strip	D-SUB pin strip
72.1 mm / 46.6 mm	75.8 mm / 63 mm
0.2 ... 4 mm ² / 0.2 ... 2.5 mm ² / 24 - 12	
0.14 ... 4 mm ² / 0.14 ... 2.5 mm ² / 26 - 14	

Ordering data

Description	No. of pos.	Module width W
VARIOFACE interface module , with D-SUB pin strip and universal labeling,		
- with screw connection	37	101 mm
- with push-in connection	37	102.8 mm
VARIOFACE interface module , with D-SUB pin strip and system-specific labeling,		
- with screw connection	37	101 mm
- with push-in connection	37	102.8 mm
VARIOFACE interface module , with D-SUB pin strip for analog input modules,		
- with screw connection	37	88 mm
- with push-in connection	37	87.6 mm

Type	Order No.	Pcs. / Pkt.
VIP-2/SC/D37SUB/M	2900676	1
VIP-2/PT/D37SUB/M	2904277	1
VIP-2/SC/D37SUB/M/SO	2900786	1
VIP-2/PT/D37SUB/M/SO	2904278	1
VIP-3/SC/D37SUB/M/HW/C300	2900675	1
VIP-3/PT/D37SUB/M/HW/C300	2904276	1

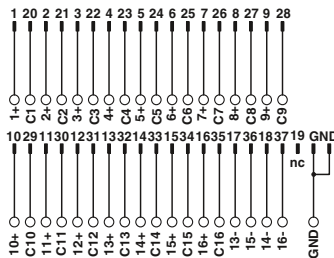

Connection scheme VIP-3/SC/D37SUB/M/HW/C300

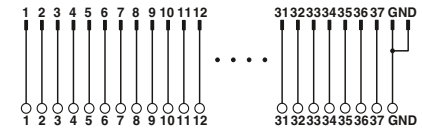

Connection scheme VIP-2/SC/D37SUB/M

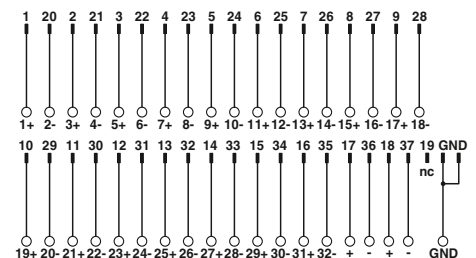

Connection scheme VIP-2/SC/D37SUB/M/SO

System cabling for controllers

VARIOFACE system cabling

Mitsubishi Electric MELSEC A, A1S, and Q System cable

For 32-/64-channel I/O boards with 37-pos. D-SUB plug-in connectors. System cables are available for connecting 1 x 32 channels or 4 x 8 channels.

Notes:

Suitable system cabling components can be configured in the INTERFACE search wizard. See www.phoenixcontact.net/products



**System cable,
D-SUB socket strip to FLK,
number of positions: 37 on 50**



**Splitting cable,
D-SUB socket strip to FLK,
number of positions: 37 on 4 x 14**



Technical data

Max. perm. operating voltage	< 50 V AC / 60 V DC
Max. perm. current carrying capacity per path	1 A
Max. conductor resistance	0.16 Ω/m
Ambient temperature (operation)	-20°C ... 50°C
Conductor cross section	AWG 26 / 0.14 mm ²
Conductor structure: stranded wires / material	7 / Cu tin-plated
Outside diameter	10.5 mm

37-pos.



Technical data

Max. perm. operating voltage	< 50 V AC / 60 V DC
Max. perm. current carrying capacity per path	1 A
Max. conductor resistance	0.16 Ω/m
Ambient temperature (operation)	-20°C ... 50°C
Conductor cross section	AWG 26 / 0.14 mm ²
Conductor structure: stranded wires / material	7 / Cu tin-plated
Outside diameter	6.3 mm

Ordering data

Description	No. of pos.	Cable length	Type	Order No.	Pcs. / Pkt.
Round cable for output module MELSEC Q Y81 P, MELSEC A1S Y81, and MELSEC A AY82EP, in standard lengths					
	37	0.5 m	FLK 50/EZ-DR/D37SUB/ 50/Y81P-O	2302599	1
	37	1 m	FLK 50/EZ-DR/D37SUB/100/Y81P-O	2302609	1
	37	2 m	FLK 50/EZ-DR/D37SUB/200/Y81P-O	2302612	1
	37	3 m	FLK 50/EZ-DR/D37SUB/300/Y81P-O	2302638	1
Round cable, same as before, however in variable lengths					
	37		FLK 50-EZ-DR-D37SUB-Y81P-O/...	2302625	1
Round cable for input module MELSEC Q X81, MELSEC A1S X81, and MELSEC A AX82, in standard lengths					
	37	0.5 m	FLK 50/EZ-DR/D37SUB/ 50/X81-I	2302641	1
	37	1 m	FLK 50/EZ-DR/D37SUB/100/X81-I	2302654	1
	37	2 m	FLK 50/EZ-DR/D37SUB/200/X81-I	2302667	1
	37	3 m	FLK 50/EZ-DR/D37SUB/300/X81-I	2302670	1
Round cable, same as before, however in variable lengths					
	37		FLK 50-EZ-DR-D37SUB-X81-I/...	2302683	1

Ordering data

Description	Order No.	Pcs. / Pkt.
CABLE-D37-M2,5/4X14/ 50/Y81P-O	2302476	1
CABLE-D37-M2,5/4X14/100/Y81P-O	2302489	1
CABLE-D37-M2,5/4X14/200/Y81P-O	2302492	1
CABLE-D37-M2,5/4X14/300/Y81P-O	2302502	1
CABLE-D37-M2,5-4X14-Y81P-O/...	2302696	1
CABLE-D37-M2,5/4X14/ 50/X81-I	2302515	1
CABLE-D37-M2,5/4X14/100/X81-I	2302528	1
CABLE-D37-M2,5/4X14/200/X81-I	2302531	1
CABLE-D37-M2,5/4X14/300/X81-I	2302544	1
CABLE-D37-M2,5-4X14-X81-I/...	2302706	1

Ordering example for system cable:

– Cable for MELSEC Q Y81P, 12.75 m long

Quantity Order No. Length [m]¹⁾

1	2302625	12.75
---	---------	-------

¹⁾ min. 0.20 m

Ordering example for splitting cable:

– Cable for MELSEC Q Y81P, 11.00 m long

Quantity Order No. Length [m]¹⁾

1	2302696	11.00
---	---------	-------

¹⁾ min. 0.20 m

**Mitsubishi Electric
MELSEC L/Q and Honeywell ML 200
System cables**

These system cables are plugged onto the I/O cards that are connected using Fujitsu plug-in connectors.

CABLE-FCN40/1X50/...

– Signal transmission of 32 channels

CABLE-FCN40/4X14/...

– Splitting up 32 channels into
4 x 8 channels

Notes:
Suitable system cabling components can be configured in the INTERFACE search wizard. See www.phoenixcontact.net/products



Fujitsu FCN plug-in connector to flat-ribbon cable, number of positions: 40 on 50



Fujitsu plug-in connector to flat-ribbon cable, number of positions: 40 on 4 x 14

Max. perm. operating voltage
Max. perm. current carrying capacity per path
Max. conductor resistance
Ambient temperature (operation)
Conductor cross section
Conductor structure: stranded wires / material

Technical data	
Max. perm. operating voltage	< 50 V AC / 60 V DC
Max. perm. current carrying capacity per path	1 A
Max. conductor resistance	0.16 Ω/m
Ambient temperature (operation)	-20°C ... 50°C
Conductor cross section	AWG 26 / 0.14 mm ²
Conductor structure: stranded wires / material	7 / Cu tin-plated

Technical data	
Max. perm. operating voltage	< 50 V AC / 60 V DC
Max. perm. current carrying capacity per path	1 A
Max. conductor resistance	0.16 Ω/m
Ambient temperature (operation)	-20°C ... 50°C
Conductor cross section	AWG 26 / 0.14 mm ²
Conductor structure: stranded wires / material	7 / Cu tin-plated

Description	No. of pos.	Cable length
Round cable in variable lengths for Mitsubishi Melsec L LX41C4, LX42C4 (common positive connection to B01, B02) LY41NT1P, LY42NT1P, LY41PT1P, LY42PT1P Mitsubishi Melsec Q QX41, QX41-S1, QX42, QX42-S1 QX71 and QX72 (common positive connection to B01, B02) QY41P, QY42P, QY71, QH42P Honeywell ML 200 2MLQ-TR4A, 2MLQ-TR8A, 2MLQ-TR4B, 2MLQ-TR8B		
	40	0.5 m
	40	1 m
	40	2 m
	40	3 m
	40	4 m
	40	6 m
	40	8 m
	40	10 m
Round cable in variable lengths for Mitsubishi Melsec L LX41C4 and LX42C4 (common negative connection to B01, B02) Mitsubishi Melsec Q QX71 and QX72 (common negative connection to B01, B02) QX82, QX82-S1 Honeywell ML 200 2MLI-D24A, 2MLI-D28B, 2MLF-SOEA (common negative connection to B01, B02)		
	40	0.5 m
	40	1 m
	40	2 m
	40	3 m
	40	4 m
	40	6 m
	40	8 m
	40	10 m
Round cable in variable lengths for Mitsubishi Melsec L LX41C4 and LX42C4 (common positive connection to B01, B02) LY41NT1P, LY42NT1P, LY41PT1P, LY42PT1P Mitsubishi Melsec Q QX41, QX41-S1, QX42, QX42-S1 QY41P (24 V), QY42P (24 V), QH42P (24 V) Honeywell ML 200 2MLQ-TR4A, 2MLQ-TR8A, 2MLQ-TR4B, 2MLQ-TR8B		
	40	0.5 m
	40	1 m
	40	2 m
	40	3 m
	40	4 m
	40	6 m
	40	8 m
	40	10 m

Ordering data		
Type	Order No.	Pcs. / Pkt.
CABLE-FCN40/1X50/ 0,5M/IM/MEL	2903468	1
CABLE-FCN40/1X50/ 1,0M/IM/MEL	2903469	1
CABLE-FCN40/1X50/ 2,0M/IM/MEL	2903470	1
CABLE-FCN40/1X50/ 3,0M/IM/MEL	2903471	1
CABLE-FCN40/1X50/ 4,0M/IM/MEL	2903472	1
CABLE-FCN40/1X50/ 6,0M/IM/MEL	2903473	1
CABLE-FCN40/1X50/ 8,0M/IM/MEL	2903474	1
CABLE-FCN40/1X50/10,0M/IM/MEL	2903475	1
CABLE-FCN40/1X50/ 0,5M/IP/MEL	2903476	1
CABLE-FCN40/1X50/ 1,0M/IP/MEL	2903477	1
CABLE-FCN40/1X50/ 2,0M/IP/MEL	2903478	1
CABLE-FCN40/1X50/ 3,0M/IP/MEL	2903479	1
CABLE-FCN40/1X50/ 4,0M/IP/MEL	2903480	1
CABLE-FCN40/1X50/ 6,0M/IP/MEL	2903481	1
CABLE-FCN40/1X50/ 8,0M/IP/MEL	2903482	1
CABLE-FCN40/1X50/10,0M/IP/MEL	2903483	1

Ordering data		
Type	Order No.	Pcs. / Pkt.
CABLE-FCN40/4X14/ 0,5M/IM/MEL	2903502	1
CABLE-FCN40/4X14/ 1,0M/IM/MEL	2903503	1
CABLE-FCN40/4X14/ 2,0M/IM/MEL	2903504	1
CABLE-FCN40/4X14/ 3,0M/IM/MEL	2903505	1
CABLE-FCN40/4X14/ 4,0M/IM/MEL	2903506	1
CABLE-FCN40/4X14/ 6,0M/IM/MEL	2903507	1
CABLE-FCN40/4X14/ 8,0M/IM/MEL	2903508	1
CABLE-FCN40/4X14/10,0M/IM/MEL	2903509	1

System cabling for controllers

VARIOFACE system cabling

OMRON CJ1, CS1, CQM1, and C200H System cable

These system cables are plugged onto the I/O cards that are connected using Fujitsu plug-in connectors.

FLK 50/EZ-DR/...

– Signal transmission of 32 channels

CABLE-FCN40...

– Splitting up 32 channels into
4 x 8 channels

CABLE-FCN24...

– Splitting up 16 channels into
2 x 8 channels



Fujitsu FCN plug-in connector to flat-ribbon cable, number of positions: 40 on 50



Fujitsu FCN plug-in connector to flat-ribbon cable, number of positions: 40 on 4 x 14 or 24 on 2 x 14



Max. perm. operating voltage
Max. perm. current carrying capacity per path
Max. conductor resistance
Ambient temperature (operation)
Conductor cross section
Conductor structure: stranded wires / material

< 50 V AC / 60 V DC
1 A
0.16 Ω/m
-20°C ... 50°C
AWG 26 / 0.14 mm²
7 / Cu tin-plated

< 50 V AC / 60 V DC
1 A
0.16 Ω/m
-20°C ... 50°C
AWG 26 / 0.14 mm²
7 / Cu tin-plated

Technical data

Technical data

Ordering data

Ordering data

Description	No. of pos.	Cable length
Round cable in variable lengths for CJ1: OD231, OD261 CS1, C200H: OD218, OD219 CQM1: OD213	40	1 m
	40	2 m
Round cable , same as before, however in variable lengths	40	
Round cable in variable lengths for CJ1: ID231, ID261 CS1 and C200H: ID111, ID216, ID217, CQM1: ID213; ID214; ID112	40	1 m
	40	2 m
Round cable , same as before, however in variable lengths	40	
Round cable in variable lengths for CS1, C200H: OD215, MD115 (only output), MD215 (only output)	24	1 m
	24	2 m
Round cable , same as before, however in variable lengths	24	
Round cable in variable lengths for CS1, C200H: ID215, MD115 (only input), MD215 (only input)	24	1 m
	24	2 m
Round cable , same as before, however in variable lengths	24	

Type	Order No.	Pcs. / Pkt.
FLK 50/EZ-DR/FCN40/100/OMR-OUT	2304144	1
FLK 50/EZ-DR/FCN40/200/OMR-OUT	2304157	1
FLK 50-EZ-DR-FCN40-OMR-OUT/...	2302829	1
FLK 50/EZ-DR/FCN40/100/OMR-IN	2304160	1
FLK 50/EZ-DR/FCN40/200/OMR-IN	2304173	1
FLK 50-EZ-DR-FCN40-OMR-IN/...	2302803	1

Type	Order No.	Pcs. / Pkt.
CABLE-FCN40/4X14/100/OMR-OUT	2304186	1
CABLE-FCN40/4X14/200/OMR-OUT	2304199	1
CABLE-FCN40-4X14-OMR-OUT/...	2302832	1
CABLE-FCN40/4X14/100/OMR-IN	2304209	1
CABLE-FCN40/4X14/200/OMR-IN	2304212	1
CABLE-FCN40-4X14-OMR-IN/...	2302816	1
CABLE-FCN24/2X14/100/OMR-OUT	2304225	1
CABLE-FCN24/2X14/200/OMR-OUT	2304238	1
CABLE-FCN24-2X14-OMR-OUT/...	2302858	1
CABLE-FCN24/2X14/100/OMR-IN	2304241	1
CABLE-FCN24/2X14/200/OMR-IN	2304254	1
CABLE-FCN24-2X14-OMR-IN/...	2302845	1

Ordering example for system cable:

– Cable for OMRON CJ1, ID231, 12.75 m long

Quantity Order No. Length [m]¹⁾

1	2302803	/	12.75
---	---------	---	-------

¹⁾ min. 0.20 m

Phoenix Contact Axioline real-time I/O System cables

These cables have been specifically developed for connecting VARIOFACE termination boards to the Axioline realtime I/O system. The push-in technology on the I/O system ensures rapid connection.

The cables have the following features:

- 1:1 connection
- 14-pos. plug-in connector, molded
- 8 pre-assembled open ends, for connection to the Axioline realtime I/O system
- Transmission of groups of 8 channels
- Labeling field on plug

Perfectly-fitting VARIOFACE termination boards round off this system concept.

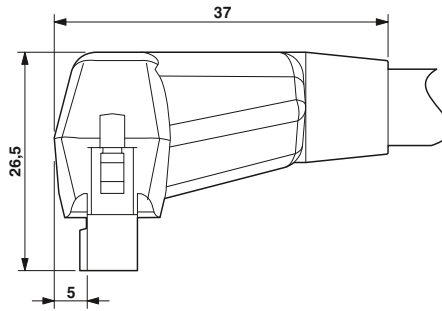

System cable for 8 channels

Notes:
 The following modules cannot be coupled due to the larger outer contour of the molded connectors:
 UM 45-FLK14/ 8IM/ZFKDS/PLC, 2965211
 UM 45- 8RM/MR-G24/1/PLC, 2962900

Max. perm. operating voltage
 Max. perm. current carrying capacity per path
 Max. conductor resistance
 Ambient temperature (operation)
 Assembly

Technical data

< 50 V AC / 60 V DC
 1 A
 0.16 Ω/m
 -20°C ... 50°C
 Insulation displacement, IEC 60352-4/DIN EN 60352-4

Conductor cross section
 Conductor structure: stranded wires / material
 Outside diameter

AWG - / 0.14 mm²
 7 / Cu tin-plated

14 -position

6.4 mm

Ordering data

Description	No. of pos.	Cable length
Round cable with an open end (8 individual wires)		
	14	0.5 m
	14	1 m
	14	1.5 m
	14	2 m
	14	2.5 m
	14	3 m
	14	4 m
	14	6 m

Type	Order No.	Pcs. / Pkt.
VIP-CAB-FLK14/AXIO/0,14/0,5M	2901604	1
VIP-CAB-FLK14/AXIO/0,14/1,0M	2901605	1
VIP-CAB-FLK14/AXIO/0,14/1,5M	2901606	1
VIP-CAB-FLK14/AXIO/0,14/2,0M	2901607	1
VIP-CAB-FLK14/AXIO/0,14/2,5M	2901608	1
VIP-CAB-FLK14/AXIO/0,14/3,0M	2901609	1
VIP-CAB-FLK14/AXIO/0,14/4,0M	2901610	1
VIP-CAB-FLK14/AXIO/0,14/6,0M	2901611	1



System cabling for controllers

VARIOFACE system cabling

Phoenix Contact Inline Front adapters

The front adapters are used to connect pre-assembled system cables directly to In-line. Front adapters are simply plugged into the relevant Inline modules. Three connection options are available:

- Transfer of 8 channels via a 14-pos. system cable
 - Transmission of 2 x 8 channels over two 14-pos. system cables
 - Transmission of 4 x 8 channels over four 14-pos. system cables
- Perfectly-fitting VARIOFACE termination boards round off this system concept.

Notes:
Suitable system cabling components can be configured in the INTERFACE search wizard. See www.phoenixcontact.net/products



Front adapters for Inline



Max. perm. operating voltage
Max. permissible current
Ambient temperature (operation)
Ambient temperature (storage/transport)
Mounting position
Standards/regulations

< 50 V AC / 60 V DC
1 A (per path)
-20°C ... 50°C
-20°C ... 70°C
Any
IEC 60664 / IEC 60664 / IEC 60664

Description	No. of pos.
VARIOFACE front adapter, for 8-channel Inline modules	
Input: IB IL 24 D 18/HD-PAC Output: IB IL 24 DO 8/HD-PAC	
VARIOFACE front adapter, for 16-channel Inline modules	
Input: IB IL 24 DI 16 Output: IB IL 24 DO 16	
VARIOFACE front adapter, for 32-channel Inline modules	
Input: IB IL 24 DI 32/HD and Output: IB IL 24 DO 32/HD	

Technical data

Ordering data

Type	Order No.	Pcs. / Pkt.
FLKM 14-PA-INLINE/DIO8	2900889	1
FLKM 14-PA-INLINE/IN16	2302751	1
FLKM 14-PA-INLINE/OUT16	2302764	1
FLKM 14-PA-INLINE/32	2302777	1

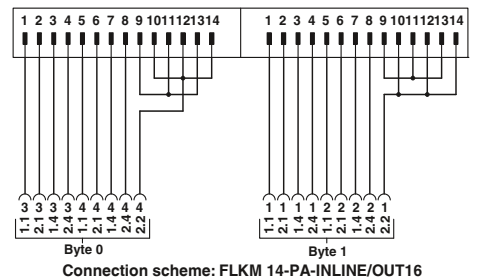

Explanation:

 Flat-ribbon cable strip
 Connection to I/O card
 Screw terminal blocks for separate supply

Schneider Electric MODICON® TSX Quantum Front adapter

The front adapters mean that pre-assembled system cables can be directly connected to I/O modules. There are two connection possibilities available:

- Transfer of max. 32 channels over one 50-pos. system cable
- Transmission of 4 x 8 channels over four 14-pos. system cables

Perfectly-fitting VARIOFACE termination boards with a variety of functions and connection possibilities round off this system concept.

Notes:

Suitable system cabling components can be configured in the INTERFACE search wizard. See www.phoenixcontact.net/products



Front adapter for MODICON TSX Quantum



Technical data

Max. perm. operating voltage
Max. permissible current

< 50 V AC / 60 V DC
1 A (per path)
4 A (per connection, supply via separate power supply)

Ambient temperature (operation)
Ambient temperature (storage/transport)
Mounting position
Standards/regulations

-20°C ... 50°C
-20°C ... 70°C
Any
DIN EN 50178 / DIN EN 50178 / DIN EN 50178

Ordering data

Description	No. of pos.
VARIOFACE front adapter , for MODICON® TSX Quantum, 1 x 32 channels can be connected	50
VARIOFACE front adapter , for MODICON® TSX Quantum, 4 x 8 channels can be connected	14

Type	Order No.	Pcs. / Pkt.
FLKM 50-PA-MODI-TSX/Q	2294306	1
FLKM 50/ 4-FLK14/PA-MODI-TSX/Q	2294416	1

Front adapter for I/O modules of MODICON® TSX Quantum automation devices

Card type	FLKM 50-PA-MODI-TSX/Q
Digital input	DDI 353 DDI 841* DDI 853 DAI 340* DAI 353** DAI 440* DAI 453**
Digital output	DDO 353
Digital input/output	DDM 390*
Analog input	ACI 030* ACI 040* ATI 030* ARI 030* AVI 030*
Analog output	ACO 020* ACO 130* AVO 020*
Analog input/output	AMM 090*
Counter	ECH 105* EHC 202*

* Only in conjunction with VIP-2/SC/FLK50/MODI-TSX/Q, Order No. 2322304.

** Only in conjunction with passive termination boards without LED.

Card type	FLKM 50/4-FLK14/PA-MODI-TSX/Q
Digital input	DDI 353 DDI 853 DAI 353** DAI 453**
Digital output	DDO 353

** Only in conjunction with passive termination boards without LED.

Explanation:

- Flat-ribbon cable strip
- Connection to I/O card
- Screw terminal blocks for separate supply

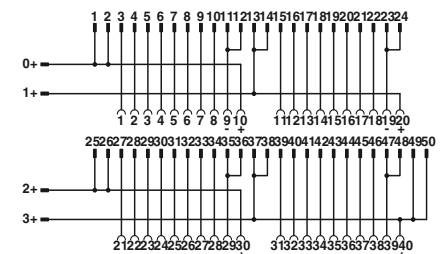

Connection scheme FLKM 50-PA-MODI-TSX/Q

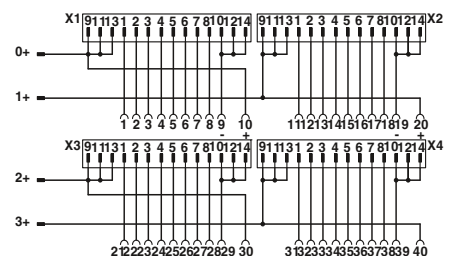

Connection scheme FLKM 50/ 4-FLK14/PA-MODI-TSX/Q

System cabling for controllers

VARIOFACE system cabling

Schneider Electric MODICON® M340 Front adapter

Pre-assembled system cables are connected directly to the 16-channel I/O modules using the front adapter. The adapters connect 2 x 8 channels of the controller via two 14-pos. system cables. Tailor-made VARIOFACE termination boards with a variety of functions and connection options are available for connection to field level and round off this system concept.



N

Front adapter for MODICON C340 series I/O modules

Card type	FLKM 14-PA-MODI/M340
Digital input	BMX DDI1602 BMX DDI1603 BMX DAI1602 BMX DAI1603
Digital output	BMX DDO1602 BMX DDO1612

Assignment table

Contacts of front adapter/ controller	Plug-in connector (byte 0)	Plug-in connector (byte 1)
1	1	
2	2	
3	3	
4	4	
5	5	
6	6	
7	7	
8	8	
9		1
10		2
11		3
12		4
13		5
14		6
15		7
16		8
17	10, 12, 14 (-)	10, 12, 14 (-)
18	9, 11, 13 (+)	9, 11, 13 (+)
19	10, 12, 14 (-)	10, 12, 14 (-)
20	9, 11, 13 (+)	9, 11, 13 (+)

Max. perm. operating voltage
Max. permissible current
Max. perm. total current

Ambient temperature (operation)
Ambient temperature (storage/transport)
Mounting position
Standards/regulations

< 50 V AC / 60 V DC
1 A (per path)
3 A (Per system cable when supplying from the module side)
10 A (When supplying via the front adapter)

-20°C ... 60°C
-20°C ... 60°C
Any
DIN EN 50178

Technical data

Ordering data

Description	No. of pos.
VARIOFACE front adapter, for MODICON® M340 with two FLK pin strips	14

Type	Order No.	Pcs. / Pkt.
FLKM 14-PA-MODI/M340	2903208	1

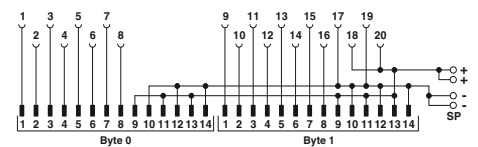

Connection scheme FLKM 14-PA-MODI/M340

Schneider Electric MODICON® M340 System cable

These system cables are plugged onto the I/O cards that are connected using Fujitsu plug-in connectors.

CABLE-FCN40/1X50/...
– Signal transmission of 32 channels

CABLE-FCN40/4X14/...
– Splitting up 32 channels into 4 x 8 channels



Fujitsu FCN plug-in connector to flat-ribbon cable, number of positions: 40 on 50



Fujitsu FCN plug-in connector to flat-ribbon cable, number of positions: 40 on 4 x 14

Notes:
Suitable system cabling components can be configured in the INTERFACE search wizard. See www.phoenixcontact.net/products

			Technical data			Technical data		
Max. perm. operating voltage			< 50 V AC / 60 V DC			< 50 V AC / 60 V DC		
Max. perm. current carrying capacity per path			1 A			1 A		
Max. conductor resistance			0.16 Ω/m			0.16 Ω/m		
Ambient temperature (operation)			-20°C ... 50°C			-20°C ... 50°C		
Conductor cross section			AWG 26 / 0.14 mm ²			AWG 26 / 0.14 mm ²		
Conductor structure: stranded wires / material			7 / Cu tin-plated			7 / Cu tin-plated		
			Ordering data			Ordering data		
Description	No. of pos.	Cable length	Type	Order No.	Pcs. / Pkt.	Type	Order No.	Pcs. / Pkt.
Round cable in variable lengths for BMX DDI 3202K, BMX DDI 6402K, BMX DD0 3202K, BMX DD0 6402K, BMX DDM 3202K	40	0,5 m	CABLE-FCN40/1X50/ 0,5M/M340	2321635	1	CABLE-FCN40/4X14/ 0,5M/M340	2321716	1
	40	1 m	CABLE-FCN40/1X50/ 1,0M/M340	2321648	1	CABLE-FCN40/4X14/ 1,0M/M340	2321729	1
	40	2 m	CABLE-FCN40/1X50/ 2,0M/M340	2321651	1	CABLE-FCN40/4X14/ 2,0M/M340	2321732	1
	40	3 m	CABLE-FCN40/1X50/ 3,0M/M340	2321664	1	CABLE-FCN40/4X14/ 3,0M/M340	2321745	1
	40	4 m	CABLE-FCN40/1X50/ 4,0M/M340	2321677	1	CABLE-FCN40/4X14/ 4,0M/M340	2321758	1
	40	6 m	CABLE-FCN40/1X50/ 6,0M/M340	2321680	1	CABLE-FCN40/4X14/ 6,0M/M340	2321761	1
	40	8 m	CABLE-FCN40/1X50/ 8,0M/M340	2321693	1	CABLE-FCN40/4X14/ 8,0M/M340	2321774	1
	40	10 m	CABLE-FCN40/1X50/10,0M/M340	2321703	1	CABLE-FCN40/4X14/10,0M/M340	2321787	1
40	15 m	CABLE-FCN40/1X50/15,0M/M340	2903748	1	CABLE-FCN40/4X14/15,0M/M340	2903749	1	

System cabling for controllers

VARIOFACE system cabling

VIP – VARIOFACE Professional front adapters for SIMATIC S7-300

Three connection options are available:

- Transfer of max. 32 channels via two 50-pos. system cables (32-channel cards or this design)
- Transfer of 4 x 8 channels via two 14-pos. system cables (32-channel cards or this design)
- Transfer of 2 x 8 channels via two 14-pos. system cables (16-channel cards or this design)

The front adapters have the following features:

- Can be screwed with I/O module
- Voltage supply via terminal blocks with spring-cage double connection
- Encapsulated socket strips for module side
Special lengths can be configured using separate order numbers.

Ordering example:

A front adapter with a connected 50-pos. system cable (32-channel cards), 12.75 m in length:

1 pcs. 2900885/12,75

Notes:
The following modules cannot be coupled due to the larger outer contour of the molded connectors: UM 45-FLK14/ 8IM/ZFKDS/PLC, 2965211 UM 45-FLK50/32IM/ZFKDS/PLC, 2965224 UM 45- 8RM/MR-G24/1/PLC, 2962900 UM 45-16RM/MR-G24/1/PLC, 2962913
Suitable system cabling components can be configured in the INTERFACE search wizard. See www.phoenixcontact.net/products

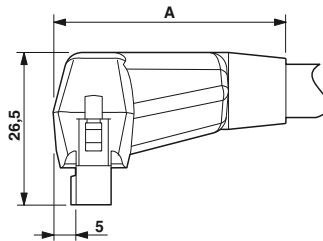

	A
...FLK14...	37
...FLK50...	42



Front adapter with system cable
1 x 32 channels can be connected

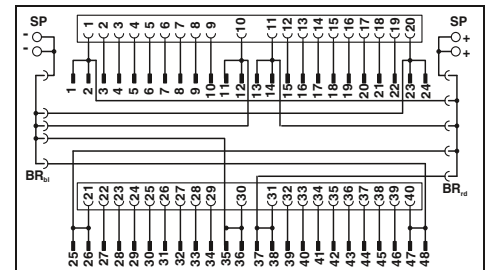

Technical data

Max. perm. operating voltage	< 50 V AC / 60 V DC
Max. perm. current carrying capacity per path	1 A (per path)
Max. perm. current (separate power supply)	8 A
Rated surge voltage	0.8 kV
Max. conductor resistance	0.16 Ω/m
Conductor cross section	AWG 26 / 0.14 mm ²
Conductor structure: stranded wires / material	7 / Cu tin-plated
Outside diameter	10.3 mm
Ambient temperature range	-20°C ... 50°C
Standards/regulations	IEC 60664, IEC 62103, DIN EN 50178
Connection method	Front adapter: Can be plugged onto 40-pos. I/O modules / separate power supply through terminal blocks with spring-cage double connection
	System cable: Flat-ribbon cable plug-in connector according to IEC 60603-13
Connection data solid / stranded / AWG	0.2 ... 2.5 mm ² / 0.2 ... 2.5 mm ² / 24 - 14

Ordering data

Description	Cable length	Type	Order No.	Pcs. / Pkt.
VIP VARIOFACE front adapter, with connected system cables for SIMATIC S7 300	0.5 m	VIP-PA-FLK50/ 0,5M/S7	2322443	1
	1 m	VIP-PA-FLK50/ 1,0M/S7	2322456	1
	1.5 m	VIP-PA-FLK50/ 1,5M/S7	2322469	1
	2 m	VIP-PA-FLK50/ 2,0M/S7	2321800	1
	2.5 m	VIP-PA-FLK50/ 2,5M/S7	2322472	1
	3 m	VIP-PA-FLK50/ 3,0M/S7	2322485	1
	4 m	VIP-PA-FLK50/ 4,0M/S7	2322498	1
	5 m	VIP-PA-FLK50/ 5,0M/S7	2322508	1
	6 m	VIP-PA-FLK50/ 6,0M/S7	2322511	1
	7 m	VIP-PA-FLK50/ 7,0M/S7	2322524	1
	8 m	VIP-PA-FLK50/ 8,0M/S7	2322537	1
	10 m	VIP-PA-FLK50/10,0M/S7	2322540	1
VIP VARIOFACE front adapter, as above, in variable lengths		VIP-PA-FLK50-S7/...	2900885	1



Front adapter with system cable
4 x 8 channels can be connected



Front adapter with system cable
2 x 8 channels can be connected

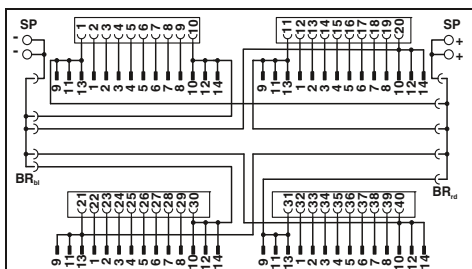

Technical data

< 50 V AC / 60 V DC
1 A (per path)
8 A

0.8 kV
0.16 Ω/m
AWG 26 / 0.14 mm²
7 / Cu tin-plated
6.4 mm
-20°C ... 50°C
IEC 60664, IEC 62103, DIN EN 50178
Can be plugged onto 40-pos. I/O modules / separate power supply through terminal blocks with spring-cage double connection

Flat-ribbon cable plug-in connector according to IEC 60603-13

0.2 ... 2.5 mm² / 0.2 ... 2.5 mm² / 24 - 14

Ordering data

Type	Order No.	Pcs. / Pkt.
VIP-PA-FLK50/4X14/ 0,5M/S7	2322553	1
VIP-PA-FLK50/4X14/ 1,0M/S7	2322566	1
VIP-PA-FLK50/4X14/ 1,5M/S7	2322579	1
VIP-PA-FLK50/4X14/ 2,0M/S7	2321910	1
VIP-PA-FLK50/4X14/ 2,5M/S7	2322582	1
VIP-PA-FLK50/4X14/ 3,0M/S7	2322595	1
VIP-PA-FLK50/4X14/ 4,0M/S7	2322605	1
VIP-PA-FLK50/4X14/ 5,0M/S7	2322618	1
VIP-PA-FLK50/4X14/ 6,0M/S7	2322621	1
VIP-PA-FLK50/4X14/ 7,0M/S7	2322634	1
VIP-PA-FLK50/4X14/ 8,0M/S7	2322647	1
VIP-PA-FLK50/4X14/10,0M/S7	2322650	1
VIP-PA-FLK50-4X14-S7/...	2900886	1

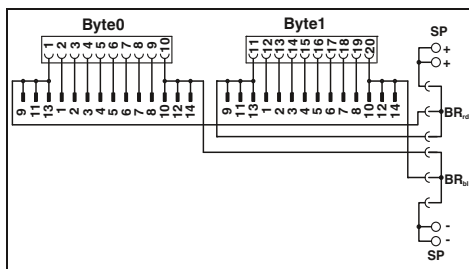

Technical data

< 50 V AC / 60 V DC
1 A (per path)
8 A

0.8 kV
0.16 Ω/m
AWG 26 / 0.14 mm²
7 / Cu tin-plated
6.4 mm
-20°C ... 50°C
IEC 60664, IEC 62103, DIN EN 50178
Can be plugged onto 20-pos. I/O modules / separate power supply through terminal blocks with spring-cage double connection

Flat-ribbon cable plug-in connector according to IEC 60603-13

0.2 ... 2.5 mm² / 0.2 ... 2.5 mm² / 24 - 14

Ordering data

Type	Order No.	Pcs. / Pkt.
VIP-PA-FLK14/ 0,5M/S7	2322663	1
VIP-PA-FLK14/ 1,0M/S7	2322676	1
VIP-PA-FLK14/ 1,5M/S7	2322689	1
VIP-PA-FLK14/ 2,0M/S7	2321790	1
VIP-PA-FLK14/ 2,5M/S7	2322692	1
VIP-PA-FLK14/ 3,0M/S7	2322702	1
VIP-PA-FLK14/ 4,0M/S7	2322715	1
VIP-PA-FLK14/ 5,0M/S7	2322728	1
VIP-PA-FLK14/ 6,0M/S7	2322731	1
VIP-PA-FLK14/ 7,0M/S7	2322744	1
VIP-PA-FLK14/ 8,0M/S7	2322757	1
VIP-PA-FLK14/10,0M/S7	2322760	1
VIP-PA-FLK14-S7/...	2900887	1

Front adapter for 32-channel cards of SIMATIC® S7-300

Card type	VIP-PA-FLK50/...M/S7
Digital input	6ES7 321-1BL00-0AA0
Digital output	6ES7 322-1BL00-0AA0
Digital input/output	6ES7 323-1BL00-0AA0
Analog input	6ES7 331-7PF01-0AB0* 6ES7 331-7PF11-0AB0* 6ES7 331-7NF00-0AB0* 6ES7 331-7NF10-0AB0* 6ES7 331-1KF01-0AB0*
Analog output	6ES7 332-5HF00-0AB0*
CPU	312C, 313C, 314C, 313C-2PiP 313C-2DP, 314C-2DP, 314C-2PiP
Other modules	6ES7 350-2AH01-0AE0* 6ES7 357-4AH01-0AE0*

Card type	VIP-PA-FLK50/4X14/...M/S7
Digital input	6ES7 321-1BL00-0AA0
Digital output	6ES7 322-1BL00-0AA0
Digital input/output	6ES7 323-1BL00-0AA0
CPU	313C, 314C, 313C-2PiP 313C-2DP, 314C-2DP, 314C-2PiP

* Only in conjunction with
VIP-2/SC/FLK50 (1-40)/S7, Order No.: 2315243,
UM 45-FLK50/ZFKDS/S7-300, Order No.: 2968111,
FLKM 50/KDS3-MT/PPA/S7-300, Order No.: 2304490.
All bridges (BR) at the adapter must be removed!

Front adapter for 16-channel cards of SIMATIC® S7-300

Card type	VIP-PA-FLK14/...M/S7
Digital input	6ES7 321-1BH02-0AA0 6ES7 321-1BH10-0AA0 6ES7 321-1BH50-0AA0* 6ES7 321-7BH01-0AB0*
Digital output	6ES7 322-1BH01-0AA0 6ES7 322-1BH10-0AA0 6ES7 322-8BF00-0AB0*
Digital input/output	6ES7 323-1BH01-0AA0
Analog input	6ES7 331-7KF02-0AB0* 6ES7 331-7HF01-0AB0* 6ES7 331-7KB02-0AB0* 6ES7 331-7TF01-0AB0*
Analog output	6ES7 332-5HD01-0AB0* 6ES7 332-5HB01-0AB0* 6ES7 332-7ND02-0AB0*
Analog input/output	6ES7 334-0CE01-0AA0* 6ES7 334-0KE00-0AB0* 6ES7 335-7HG01-0AB0*
Other modules	6ES7 338-4BC01-0AB0* 6ES7 350-1AH03-0AE0* 6ES7 351-1AH01-0AE0* 6ES7 352-1AH02-0AE0* 6ES7 353-1AH01-0AE0* 6ES7 354-1AH01-0AE0* 6ES7 355-0VH10-0AE0* 6ES7 355-1VH10-0AE0*

* Only in conjunction with
IP-2/SC/2FLK14 (1-20)/S7, Order No.: 2315230
UM 45-2FLK14/ZFKDS/S7, Order No.: 2965156
FLKM-2FLK14/KDS 3-MT/PPA/S7, Order No.: 2295062
All bridges (BR) on the adapter must be disconnected.

Note:
The front adapters are non-isolated on delivery.
Removal of the bridges can achieve electrical isolation (in groups of 8).

Explanation:

 Flat-ribbon cable strip
 Connection to I/O card

SP: Separate power terminals
BRbl: Blue plug-in bridge
BRrd: Red plug-in bridge

System cabling for controllers

VARIOFACE system cabling

Siemens SIMATIC® S7-300 Front adapter

I/O modules with 32 channels or with this design

There are two connection possibilities available:

- Transfer of max. 32 channels over one 50-pos. system cable
- Transmission of 4 x 8 channels over four 14-pos. system cables

Perfectly-fitting VARIOFACE termination boards with a variety of functions and connection possibilities round off this system concept.

Notes:

Suitable system cabling components can be configured in the INTERFACE search wizard. See www.phoenixcontact.net/products



Front adapter for SIMATIC® S7-300, I/O cards with max. 32 channels



Technical data

Max. perm. operating voltage
Max. permissible current

< 50 V AC / 60 V DC
1 A (per path)
8 A (per connection, supply via separate power supply (2.8 x 0.8 mm))

Max. perm. total current

2 A (Per Byte, for supply via connector)
8 A (during supply via a separate bridged power supply)

Ambient temperature (operation)
Ambient temperature (storage/transport)
Standards/regulations
Connection method

-20°C ... 50°C
-20°C ... 70°C
IEC 60664 / IEC 60664 / IEC 60664
IDC/FLK pin strip (2.54 mm)

Ordering data

Description	No. of pos.
VARIOFACE front adapters, for SIMATIC® S7-300	
- 1 x 32 channels can be connected	50
- 4 x 8 channels can be connected	14

Type	Order No.	Pcs. / Pkt.
FLKM 50-PA-S300	2294445	1
FLKM 50/4-FLK14/PA-S300	2296281	1

Front adapter for 32-channel cards of SIMATIC® S7-300

Card type	FLKM 50-PA-S300
Digital input	6ES7 321-1BL00-0AA0
Digital output	6ES7 322-1BL00-0AA0
Digital input/output	6ES7 323-1BL00-0AA0
Analog input	6ES7 331-7PF01-0AB0* 6ES7 331-7PF11-0AB0* 6ES7 331-7NF00-0AB0* 6ES7 331-7NF10-0AB0* 6ES7 331-1KF01-0AB0*
Analog output	6ES7 332-5HF00-0AB0*
CPU	312C, 313C, 314C, 313C-2PiP 313C-2DP, 314C-2DP, 314C-2PiP
Other modules	6ES7 350-2AH01-0AE0* 6ES7 357-4AH01-0AE0*

Card type	FLKM 50/4-FLK14/PA-S300
Digital input	6ES7 321-1BL00-0AA0
Digital output	6ES7 322-1BL00-0AA0
Digital input/output	6ES7 323-1BL00-0AA0
CPU	313C, 314C, 313C-2PiP 313C-2DP, 314C-2DP, 314C-2PiP

* Only in conjunction with
VIP-2/SC/FLK50 (1-40)/S7, Order No.: 2315243,
UM 45-FLK50/ZFKDS/S7-300, Order No.: 2968111,
FLKM 50/KDS3-MT/PPA/S7-300, Order No.: 2304490.
All wire bridges (DR) on the adapter must be disconnected!
There must be no voltage supply at the front adapter (flowing via the slip-on connections)!

Note:

The front adapters are non-isolated on delivery.
Removal of the bridges can achieve electrical isolation (in groups of 8).

Explanation:

- Flat-ribbon cable strip
- Connection to I/O card
- Screw terminal blocks for separate supply

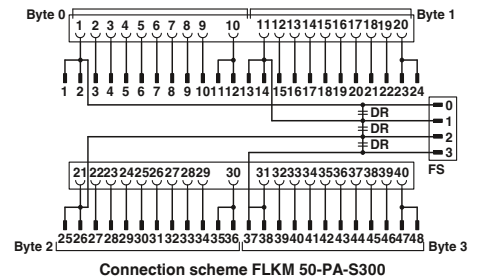

Connection scheme FLKM 50-PA-S300

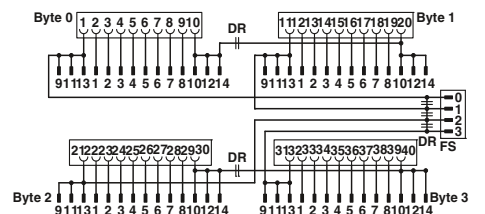

Connection scheme FLKM 50/4-FLK14/PA-S300

Siemens SIMATIC® S7-300
Front adapter

I/O modules with 16 channels or with this design

– Up to 2 x 8 channels are connected via two 14-pos. system cables.

Perfectly-fitting VARIOFACE termination boards with a variety of functions and connection possibilities round off this system concept.

Notes:
Suitable system cabling components can be configured in the INTERFACE search wizard. See www.phoenixcontact.net/products



Front adapter for SIMATIC® S7-300, I/O cards with max. 16 channels



Technical data

Max. perm. operating voltage	< 50 V AC / 60 V DC
Max. permissible current	1 A (per path) 8 A (per connection, supply via separate power supply (2.8 x 0.8 mm))
Max. perm. total current	2 A (Per Byte, for supply via connector) 8 A (during supply via a separate bridged power supply)
Ambient temperature (operation)	-20°C ... 50°C
Ambient temperature (storage/transport)	-20°C ... 70°C
Standards/regulations	IEC 60664 / IEC 60664 / IEC 60664
Connection method	IDC/FLK pin strip (2.54 mm)

Ordering data

Description	No. of pos.	Type	Order No.	Pcs. / Pkt.
VARIOFACE front adapters, for SIMATIC® S7-300				
- 2 x 8 channels can be connected	14	FLKM 14-PA-S300	2299770	1

Front adapter for 16-channel cards of SIMATIC® S7-300

Card type	FLKM 14-PA-S300
Digital input	6ES7 321-1BH02-0AA0 6ES7 321-1BH10-0AA0 6ES7 321-1BH50-0AA0* 6ES7 321-7BH01-0AB0*
Digital output	6ES7 322-1BH01-0AA0 6ES7 322-1BH10-0AA0 6ES7 322-8BF00-0AB0*
Digital input/output	6ES7 323-1BH01-0AA0
Analog input	6ES7 331-7KF02-0AB0* 6ES7 331-7HF01-0AB0* 6ES7 331-7KB02-0AB0* 6ES7 331-7TF01-0AB0*
Analog output	6ES7 332-5HD01-0AB0* 6ES7 332-5HB01-0AB0* 6ES7 332-7ND02-0AB0*
Analog input/output	6ES7 334-0CE01-0AA0* 6ES7 334-0KE00-0AB0* 6ES7 335-7HG01-0AB0*
Other modules	6ES7 338-4BC01-0AB0* 6ES7 350-1AH03-0AE0* 6ES7 351-1AH01-0AE0* 6ES7 352-1AH02-0AE0* 6ES7 353-1AH01-0AE0* 6ES7 354-1AH01-0AE0* 6ES7 355-0VH10-0AE0* 6ES7 355-1VH10-0AE0*

* Only in conjunction with
VIP-2/SC/2FLK14 (1-20)/S7, Order No.: 2315230
UM 45-2FLK14/ZFKDS/S7, Order No.: 2965156
FLKM-2FLK14/KDS 3-MT/PPA/S7, Order No.: 2295062
All wire bridges (DR) on the adapter must be disconnected.
There must be no voltage supply at the front adapter (flowing via the slip-on connections)!

Note:
The front adapters are non-isolated on delivery.
Removal of the bridges can achieve electrical isolation (in groups of 8).

Explanation:

 Flat-ribbon cable strip
 Connection to I/O card
 Screw terminal blocks for separate supply

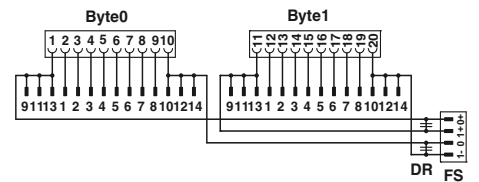

Connection scheme FLKM 14-PA-S300

System cabling for controllers

VARIOFACE system cabling

Siemens SIMATIC® S7-300 Front adapter for failsafe modules

The front adapters are coupled using 50-pos. system cables and convert the signals for passive modules.



Siemens SIMATIC S7-300 front adapter for failsafe I/O cards

Technical data

Max. perm. operating voltage	30 V DC
Max. permissible current	1 A (per path)
Max. perm. total current	2 A
Ambient temperature (operation)	-20°C ... 50°C
Ambient temperature (storage/transport)	-20°C ... 70°C
Standards/regulations	EN 50178
Connection method	Flat-ribbon cable plug-in connector according to IEC 60603-13

Ordering data

Description	No. of pos.	Type	Order No.	Pcs. / Pkt.
VARIOFACE front adapter for failsafe I/O cards				
6ES7 326-1BK02-0AB0 6ES7 326-1RF00-0AB0 6ES7 336-1HE00-0AB0	50	FLKM 50-PA-S300/SO167	2307662	1
VARIOFACE front adapter for failsafe I/O cards				
6ES7 326-2BF01-0AB0	50	FLKM 50-PA/DO326/S7-300	2321952	1

Front adapter for I/O modules of SIMATIC® S7-300

Card type	FLKM 50-PA-S300/SO167
Digital input	6ES7 326-1BK02-0AB0* 6ES7 326-1RF00-0AB0**)
Analog input	6ES7 336-1HE00-0AB0*
<hr/>	
Card type	FLKM 50-PA/DO326/S7-300
Digital output	6ES7 326-2BF01-0AB0** 6ES7 326-2BF10-0AB0**

* Only in conjunction with
VIP-2/SC/FLK50 (1-40)/S7, Order No. 2315243,
UM 45-FLK50/ZFKDS/S7-300, Order No. 2968111,
FLKM 50/KDS3-MT/PPA/S7-300, Order No. 2304490.

** Only in conjunction with
FLKM 50/DO326/S7-300, Order No. 2321965.

1) Not suitable for signals from the Ex area.

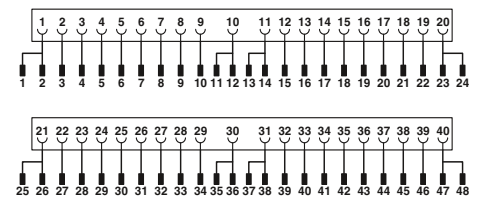

Connection scheme FLKM 50-PA-S300/SO167

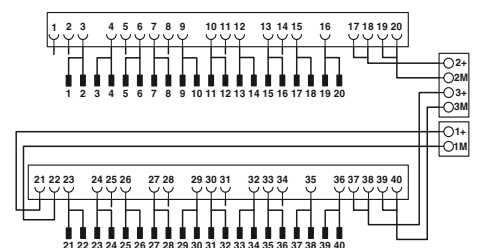

Connection scheme FLKM 50-PA/DO326/S7-300

Explanation:

- Flat-ribbon cable strip
- Connection to I/O card
- Screw terminal blocks for separate supply

Siemens SIMATIC S7 -300
System cables for 64-channel I/O cards

These system cables are plugged onto the 64-channel (2x32) I/O cards that are directly connected using plug-in connectors.

CABLE-FCN40/1X50/...

- Signal transmission of 1 x 32 channels
- System cable: 40-pos. plug-in connector on 50-pos. flat-ribbon cable strip

CABLE-FCN40/4X14/...

- Signal transmission of 4 x 8 channels
- Splitting cable: 40-pos. plug-in connector on four 14-pos. flat-ribbon cable strips



System cable



Splitting cable

Max. perm. operating voltage
 Max. perm. current carrying capacity per path
 Max. conductor resistance
 Ambient temperature (operation)
 Conductor cross section
 Conductor structure: stranded wires / material

Technical data	
< 50 V AC / 60 V DC	
1 A	
0.16 Ω/m	
-20°C ... 50°C	
AWG 26 / 0.14 mm ²	
7 / Cu tin-plated	

Technical data	
< 50 V AC / 60 V DC	
1 A	
0.16 Ω/m	
-20°C ... 50°C	
AWG 26 / 0.14 mm ²	
7 / Cu tin-plated	

Description	No. of pos.	Cable length
Round cable, for output module 6ES7 322-1BP00-0AA0 and 6ES7 322-1BP50-0AA0 (two cables per module)		
	40	0.5 m
	40	1 m
	40	2 m
	40	3 m
	40	4 m
	40	6 m
	40	8 m
	40	10 m
Round cable, for input module 6ES7 321-1BP00-0AA0 (two cables per module). Plus-reading operation (sinking mode) of the module		
	40	0.5 m
	40	1 m
	40	2 m
	40	3 m
	40	4 m
	40	6 m
	40	8 m
	40	10 m

Ordering data		
Type	Order No.	Pcs. / Pkt.
CABLE-FCN40/1X50/ 0,5M/S7-OUT	2321017	1
CABLE-FCN40/1X50/ 1,0M/S7-OUT	2321020	1
CABLE-FCN40/1X50/ 2,0M/S7-OUT	2321033	1
CABLE-FCN40/1X50/ 3,0M/S7-OUT	2321046	1
CABLE-FCN40/1X50/ 4,0M/S7-OUT	2321059	1
CABLE-FCN40/1X50/ 6,0M/S7-OUT	2321062	1
CABLE-FCN40/1X50/ 8,0M/S7-OUT	2321075	1
CABLE-FCN40/1X50/10,0M/S7-OUT	2321088	1
CABLE-FCN40/1X50/ 0,5M/S7-IN	2321091	1
CABLE-FCN40/1X50/ 1,0M/S7-IN	2321101	1
CABLE-FCN40/1X50/ 2,0M/S7-IN	2321114	1
CABLE-FCN40/1X50/ 3,0M/S7-IN	2321127	1
CABLE-FCN40/1X50/ 4,0M/S7-IN	2321130	1
CABLE-FCN40/1X50/ 6,0M/S7-IN	2321143	1
CABLE-FCN40/1X50/ 8,0M/S7-IN	2321156	1
CABLE-FCN40/1X50/10,0M/S7-IN	2321169	1

Ordering data		
Type	Order No.	Pcs. / Pkt.
CABLE-FCN40/4X14/ 0,5M/S7-OUT	2321172	1
CABLE-FCN40/4X14/ 1,0M/S7-OUT	2321185	1
CABLE-FCN40/4X14/ 2,0M/S7-OUT	2321198	1
CABLE-FCN40/4X14/ 3,0M/S7-OUT	2321208	1
CABLE-FCN40/4X14/ 4,0M/S7-OUT	2321211	1
CABLE-FCN40/4X14/ 6,0M/S7-OUT	2321224	1
CABLE-FCN40/4X14/ 8,0M/S7-OUT	2321237	1
CABLE-FCN40/4X14/10,0M/S7-OUT	2321240	1
CABLE-FCN40/4X14/ 0,5M/S7-IN	2321253	1
CABLE-FCN40/4X14/ 1,0M/S7-IN	2321266	1
CABLE-FCN40/4X14/ 2,0M/S7-IN	2321279	1
CABLE-FCN40/4X14/ 3,0M/S7-IN	2321282	1
CABLE-FCN40/4X14/ 4,0M/S7-IN	2321295	1
CABLE-FCN40/4X14/ 6,0M/S7-IN	2321305	1
CABLE-FCN40/4X14/ 8,0M/S7-IN	2321318	1
CABLE-FCN40/4X14/10,0M/S7-IN	2321321	1

System cabling for controllers

VARIOFACE system cabling

Siemens SIMATIC® S7-300 Front adapter for MINI MCR

This front adapter is used exclusively for coupling the MINI MCR-SL-V8-FLK 16 A adapter. Changed analog standard signals can be transmitted with the help of these components.

Suitable isolators can be seen from page 66.

For suitable 16-pos. system cable (FLK 16/EZ-DR/...), refer to page 506.



Front adapter for SIMATIC® S7-300,
20-pos. analog I/O boards



Max. perm. operating voltage
Max. permissible current

Ambient temperature (operation)
Ambient temperature (storage/transport)
Standards/regulations

Certification data	
Nominal voltage/current	CUL - / -
Nominal voltage/current	UL - / -

Technical data

FLKM 16-PA-S300/MINI-MCR
30 V AC/DC
50 mA (per path)
500 mA (per connection, supply via separate power supply)

-20°C ... 60°C
-20°C ... 70°C
DIN EN 50178 / DIN EN 50178

Ordering data

Type	Order No.	Pcs. / Pkt.
FLKM 16-PA-S300/MINI-MCR	2314749	1

Accessories

FLK 16/EZ-DR/ 300/KONFEK	2299330	1
MINI MCR-SL-V8-FLK 16-A	2811268	1

Front adapter for analog cards of SIMATIC® S7-300

Card type	FLKM 16-PA-S300/MINI-MCR
Analog input	6ES7 331-7KF02-0AB0 6ES7 331-7KB02-0AB0 6ES7 331-7KB81-0AB0 6ES7 331-7TF00-0AB0
Analog output	6ES7 332-8TF01-0AB0

Description	No. of pos.
VARIOFACE front adapter, for SIMATIC® S7-300, only in connection with MINI MCR-SL-V8-FLK 16-A	16

Assembled round cable, with two 16-pos. socket strips

System adapter, for MINI analog modules with screw connection

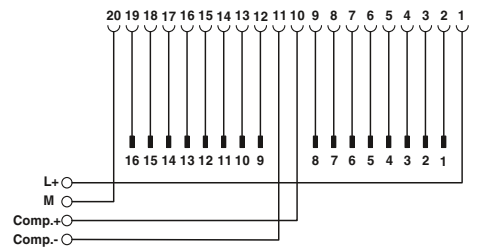
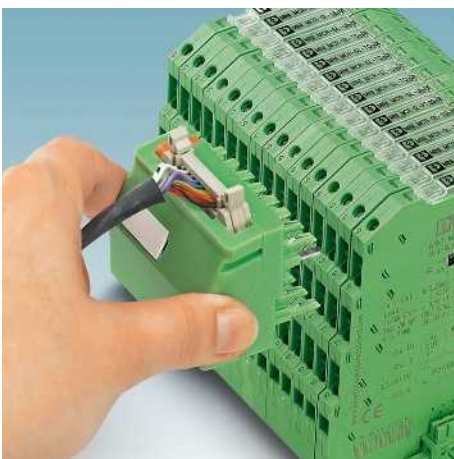

FLKM 16-PA-S300/MINI-MCR connection scheme

Explanation:

- Flat-ribbon cable strip
- Connection to I/O card
- Screw terminal blocks for separate supply

Siemens SIMATIC® S7-300 Front adapter for MINI analog system cabling

The FLKM 16-PA-331-1KF//MINI-MCR front adapter is used for implementing system cabling in conjunction with the MINI Analog system adapter and a 16-pos. system cable FLK 16/EZ-DR/.../KONFEK; refer to page 506.

Instead of the conventional front plug, screw terminal blocks are used to snap this component onto the analog module.

The DIP switches can be used to connect "M-" connections to each other and to the central ground of the system.

The front adapter supports **only current signals**.

The front adapter is suitable for the following analog input card:

– 6ES7 331-1KF02-0AB0

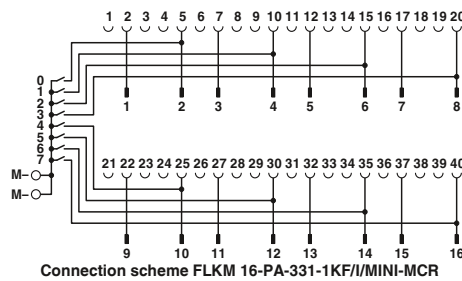

Max. perm. operating voltage
Max. permissible current
Rated surge voltage / insulation
Ambient temperature (operation)
Ambient temperature (storage/transport)
Standards/regulations

30 V AC/DC
50 mA (per path)
0.5 kV / basic insulation
-20°C ... 60°C
-20°C ... 70°C
DIN EN 50178 / DIN EN 50178

Description	No. of pos.
VARIOFACE front adapter , for SIMATIC® S7-300, only in connection with MINI MCR-SL-V8-FLK 16-A	16

Ordering data		
Type	Order No.	Pcs. / Pkt.
FLKM 16-PA- 331-1KF//MINI-MCR	2318237	1



Front adapter for SIMATIC® S7-300,
6ES7 331-1KF02-0AB0 analog I/O board

Technical data

Siemens SIMATIC® S7-300 Front adapter for MINI analog system cabling

The FLKM 16-PA-332-5HF//MINI-MCR front adapter is used for implementing system cabling in conjunction with the MINI Analog system adapter and a 16-pos. system cable FLK 16/EZ-DR/.../KONFEK; refer to page 506.

Instead of the conventional front plug, screw terminal blocks are used to snap this component on to the analog module.

The front adapter supports **only current signals**.

The front adapter is suitable for the following analog output cards:

– 6ES7 332-5HF00-0AB0

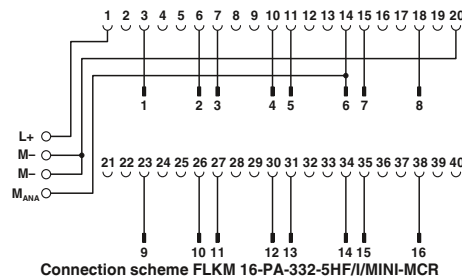

Max. perm. operating voltage
Max. permissible current
Rated surge voltage / insulation
Ambient temperature (operation)
Ambient temperature (storage/transport)
Standards/regulations

30 V AC/DC
50 mA (per path)
500 mA (per connection, supply via separate power supply)
0.5 kV / basic insulation
-20°C ... 60°C
-20°C ... 70°C
DIN EN 50178 / DIN EN 50178

Description	No. of pos.
VARIOFACE front adapter , for SIMATIC® S7-300, only in connection with MINI MCR-SL-V8-FLK 16-A	16

Ordering data		
Type	Order No.	Pcs. / Pkt.
FLKM 16-PA- 332-5HF//MINI-MCR	2318240	1



Front adapter for SIMATIC® S7-300,
6ES7 332-5HF00-0AB0 analog I/O board

Technical data

VARIOFACE system cabling

Siemens SIMATIC® S7-1500 System cables for front plugs from the “TOP connect” series

These system cables are connected directly to Siemens “SIMATIC TOP connect” front plugs. A VARIOFACE front adapter is not required. The cables can be used to connect existing 8-channel Phoenix Contact termination boards.

- For passive signal transmission, e.g., VIP-2/SC/FLK14/PLC; Order No. 2315214, see page 470.
- For relay or solid-state relay connection via V8 adapters, e.g., PLC-V8/FLK14/OUT; Order No. 2295554, see page 369.

The system cables are available in the following versions:

- Unshielded
- Shielded
- Halogen-free
- Encapsulated plug-in connector

Details regarding assignment to Siemens modules are provided with the system cable order numbers at www.phoenixcontact.net/products.



N

Max. perm. operating voltage	< 50 V AC / 60 V DC
Max. perm. current carrying capacity per path	1 A
Max. conductor resistance	0.16 Ω/m
Ambient temperature (operation)	-20°C ... 50°C
Assembly	Insulation displacement, IEC 60352-4/DIN EN 60352-4
Number of positions, control side	16
Number of positions, module side	14
Conductor cross section	AWG 26 / 0.14 mm ²
Conductor structure: stranded wires / material	7 / Cu tin-plated
Outside diameter	6.4 mm



Technical data

Max. perm. operating voltage	< 50 V AC / 60 V DC
Max. perm. current carrying capacity per path	1 A
Max. conductor resistance	0.16 Ω/m
Ambient temperature (operation)	-20°C ... 50°C
Assembly	Insulation displacement, IEC 60352-4/DIN EN 60352-4
Number of positions, control side	16
Number of positions, module side	14
Conductor cross section	AWG 26 / 0.14 mm ²
Conductor structure: stranded wires / material	7 / Cu tin-plated
Outside diameter	6.4 mm

Ordering data

Description	Cable length	Type	Order No.	Pcs. / Pkt.
Unshielded round cables , with one 16-pos. and one 14-pos. socket strip in fixed lengths for transmitting 8 channels				
	0.5 m	FLK 14/16/EZ-DR/ 50/S7	2293815	5
	1 m	FLK 14/16/EZ-DR/ 100/S7	2293828	1
	1.5 m	FLK 14/16/EZ-DR/ 150/S7	2293831	1
	2 m	FLK 14/16/EZ-DR/ 200/S7	2293844	1
	2.5 m	FLK 14/16/EZ-DR/ 250/S7	2293857	1
	3 m	FLK 14/16/EZ-DR/ 300/S7	2293860	1
	4 m	FLK 14/16/EZ-DR/ 400/S7	2293886	1
	5 m	FLK 14/16/EZ-DR/ 500/S7	2293899	1
	6 m	FLK 14/16/EZ-DR/ 600/S7	2293909	1
	7 m	FLK 14/16/EZ-DR/ 700/S7	2293912	1
	8 m	FLK 14/16/EZ-DR/ 800/S7	2293925	1
	9 m	FLK 14/16/EZ-DR/ 900/S7	2293938	1
	10 m	FLK 14/16/EZ-DR/1000/S7	2293941	1
Unshielded round cables , as above, but in variable lengths of type “FLK EZ-DR/14U/C52/...”				
		FLK EZ-DR.../.../...	2295059	1
Shielded round cables , with one 16-pos. and one 14-pos. socket strip, for transmitting 8 channels in variable lengths of type “FLK EZ-DR-S/14S/C52/...”				
		FLK EZ-DR-S.../.../...	2295046	1
Unshielded halogen-free round cables , with one 16-pos. and one 14-pos. socket strip, for transmitting 8 channels in variable lengths				

N



**Halogen-free
(only the cable)**

N



**One encapsulated plug-in connector
(on module side, 14-pos.)**

Pin assignment and color code:

- FLK 14/16/EZ-DR/.../S7
- FLK 14/16/EZ-DR/HF/.../S7
- VIP-CAB-FLK14/16/.../S7

14-pos. socket strip PIN	16-pos. socket strip PIN	Wire color
1	16	Black
2	14	Brown
3	12	Red
4	10	Orange
5	8	Yellow
6	6	Green
7	4	Blue
8	2	Violet
9	9	Gray
10	1	White
11	11	White-black
12	3	White-brown
13	13	White-red
14	5	White-orange
Not used	7	-
Not used	15	-

Technical data
< 50 V AC / 60 V DC
1 A
0.16 Ω/m
-20°C ... 50°C
Insulation displacement, IEC 60352-4/DIN EN 60352-4
16
14
AWG 26 / 0.14 mm ²
7 / Cu tin-plated
6.4 mm

Technical data
< 50 V AC / 60 V DC
1 A
0.16 Ω/m
-20°C ... 50°C
Insulation displacement, IEC 60352-4/DIN EN 60352-4
16
14
AWG 26 / 0.14 mm ²
7 / Cu tin-plated
6.4 mm

Ordering data		
Type	Order No.	Pcs. / Pkt.
FLK 14/16/EZ-DR/HF/ 50/S7	2296919	1
FLK 14/16/EZ-DR/HF/ 100/S7	2296922	1
FLK 14/16/EZ-DR/HF/ 150/S7	2296935	1
FLK 14/16/EZ-DR/HF/ 200/S7	2296948	1
FLK 14/16/EZ-DR/HF/ 250/S7	2296951	1
FLK 14/16/EZ-DR/HF/ 300/S7	2296964	1
FLK 14/16/EZ-DR/HF/ 400/S7	2904525	1
FLK 14/16/EZ-DR/HF/ 500/S7	2304704	1
FLK 14/16/EZ-DR/HF/ 600/S7	2904526	1
FLK 14/16/EZ-DR/HF/ 800/S7	2904527	1
FLK 14/16/EZ-DR/HF/1000/S7	2904528	1
FLK 14-16-EZ-DR-HF-S7/...	2295693	1

Ordering data		
Type	Order No.	Pcs. / Pkt.
VIP-CAB-FLK14/16/0,5M/S7	2904514	1
VIP-CAB-FLK14/16/1,0M/S7	2904515	1
VIP-CAB-FLK14/16/1,5M/S7	2904516	1
VIP-CAB-FLK14/16/2,0M/S7	2904517	1
VIP-CAB-FLK14/16/2,5M/S7	2904518	1
VIP-CAB-FLK14/16/3,0M/S7	2904519	1
VIP-CAB-FLK14/16/4,0M/S7	2904520	1
VIP-CAB-FLK14/16/5,0M/S7	2904521	1
VIP-CAB-FLK14/16/6,0M/S7	2904522	1
VIP-CAB-FLK14/16/8,0M/S7	2904523	1
VIP-CAB-FLK14/16/10,0M/S7	2904524	1

Encapsulated 14-pos. plug-in connector:

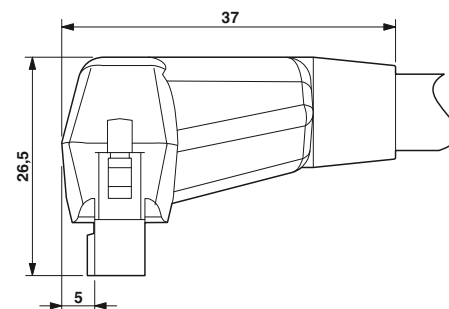

Note:
The following modules cannot be coupled due to the larger outer contour of the molded 14-pos. plug-in connector:
UM 45-FLK14/ 8IM/ZFKDS/PLC, 2965211
UM 45- 8RM/MR-G24/1/PLC, 2962900

Ordering example for unshielded round cable:
Unshielded round cable, assembled with one 14-pos. and one 16-pos. socket strip, 12.70 m long
Type: FLK EZ-DR /14U/C52/...

Quantity	Order No.	Length [m] ¹⁾
1	2295059/14U/C52	12.70

¹⁾ Min. 0.20 m

14U ≙ 14-pos. unshielded cable
C52 ≙ S7-1500 assembly with 14-pos. socket strip at one end and 16-pos. socket strip at the other

Ordering example for shielded round cable:
Unshielded round cable, assembled with one 14-pos. and one 16-pos. socket strip, 13.20 m long
Type: FLK EZ-DR-S /14S/C52/...

Quantity	Order No.	Length [m] ¹⁾
1	2295046/14S/C52	13.20

¹⁾ Min. 0.20 m

14S ≙ 14-pos. shielded cable
C52 ≙ S7-1500 assembly with 14-pos. socket strip at one end and 16-pos. socket strip at the other

Ordering example for halogen-free round cable:
Halogen-free round cable, assembled with one 14-pos. and one 16-pos. socket strip, 15.50 m long
Type: FLK 14-16-EZ-DR-HF-S7/...

Quantity	Order No.	Length [m] ¹⁾
1	2295693	15.50

¹⁾ Min. 0.20 m

System cabling for controllers

VARIOFACE system cabling

Siemens SIMATIC® S7-400 Front adapter

The front adapters mean that pre-assembled system cables can be directly connected to I/O modules.

FLKM 50-PA-S400

– Transmission of max. 32 digital channels over one 50-pos. system cable.

FLKM 50/4-FLK14/PA-S400

– Transmission of max. 32 digital channels via one 14-pos. system cable.

Perfectly-fitting VARIOFACE termination boards with a variety of functions and connection possibilities round off this system concept.

FLKM 50-PA-S400 (3-48)

– Analog channels are connected via a 50-pos. system cable.

The 1:1 connection of the adapter means that corresponding 1:1 interface modules are connected here



Front adapter for SIMATIC® S7-400



Technical data

Max. perm. operating voltage	< 50 V AC / 60 V DC
Max. permissible current	1 A (per path) 8 A (per connection, supply via separate power supply)
Max. perm. total current	2 A (Per Byte, for supply via connector) 8 A (during supply via a separate bridged power supply)
Ambient temperature (operation)	-20°C ... 50°C
Ambient temperature (storage/transport)	-20°C ... 70°C
Mounting position	Any
Standards/regulations	IEC 60664 / IEC 60664 / IEC 60664

Front adapter for I/O modules of the Siemens automation equipment SIMATIC® S7-400

Card type	FLKM 50-PA-S400
Digital input	6ES7 421-1BL01-0AA0 6ES7 421-7BH01-0AB0* 6ES7 421-7DH00-0AB0*
Digital output	6ES7 422-1BL00-0AA0 6ES7 422-7BL00-0AB0

Card type	FLKM 50/4-FLK14/PA-S400
Digital input	6ES7 421-1BL01-0AA0
Digital output	6ES7 422-1BL00-0AA0 6ES7 422-7BL00-0AB0

Card type	FLKM 50-PA-S400 (3-48)
Analog input	6ES7 431-0HH00-0AB0** 6ES7 431-1KF00-0AB0** 6ES7 431-1KF10-0AB0** 6ES7 431-1KF20-0AB0** 6ES7 431-7KF00-0AB0** 6ES7 431-7KF10-0AB0** 6ES7 431-7QH00-0AB0**
Analog output	6ES7 432-1HF00-0AB0**

* Only in connection with VIP-2/SC/FLK50/S7/A-S400, Order No.: 2322359
All wire bridges (DR) on the adapter must be disconnected.

** Only in connection with VIP-3/SC/FLK50, Order No.: 2315081
UM 45-FLK 50/ZFKDS, Order No.: 2293585
UM 45-FLKS 50/ZFKDS, Order No.: 2968470
FLKM 50/KDS 3-MT/PPA/AN/PLC, Order No.: 2291587

Description	No. of pos.
VARIOFACE front adapter, for	
- SIMATIC® S7-400, 1 x 32 channels can be connected	50
- SIMATIC® S7-400, 4 x 8 channels can be connected	14
- SIMATIC® S7-400, only analog	50

Ordering data

Type	Order No.	Pcs. / Pkt.
FLKM 50-PA-S400	2294500	2
FLKM 50/ 4-FLK14/PA-S400	2294429	2
FLKM 50-PA-S400(3-48)	2294908	2

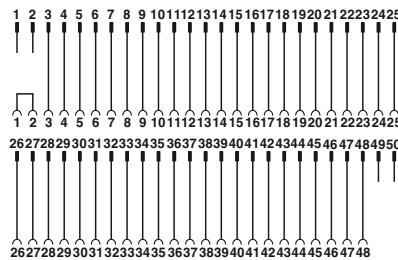

Connection scheme FLKM 50-PA-S400 (3-48)

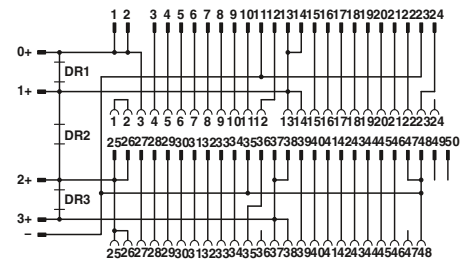

Connection scheme FLKM 50-PA-S400

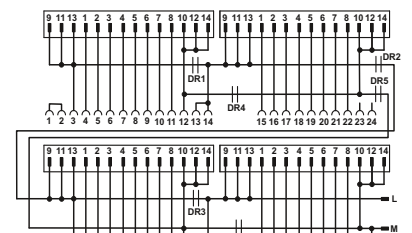

Connection scheme: FLKM 50/4-FLK14/PA-S400

Explanation:

- Flat-ribbon cable strip
- Connection to I/O card
- Screw terminal blocks for separate supply

Siemens SIMATIC® S7-400 Adapter for conversion from S5-135/155 to S7-400

The FLKM S135/... adapters connect a SIMATIC® S5 connector wired with individual conductors directly to the SIMATIC® S7-400 basic card.

The SIMATIC® S5 connector is plugged directly onto an S7-400-I/O card with the help of an FFLKM S135/... intermediate adapter.

A new SIMATIC® S7-400 is installed in place of the SIMATIC® S5. The existing field wiring remains intact.

Attention:

The LEDs of the S7-400 module are hidden.



Adapter for Siemens SIMATIC® S5-135/S7-400



Max. perm. operating voltage	24 V AC/DC
Max. permissible current	4 A (per path)
Test voltage (contact/contact)	500 V (50 Hz, 1 min.)
Ambient temperature (operation)	-20°C ... 50°C
Mounting position	Any
Standards/regulations	-

Technical data			
①	②	③	④
24 V AC/DC	60 V DC	24 V DC	24 V AC/DC
4 A (per path)	2 A (per path)	4 A (per path)	4 A (per path)
500 V (50 Hz, 1 min.)	1.25 kV (50 Hz, 1 min.)	1.25 kV (50 Hz, 1 min.)	1.25 kV (50 Hz, 1 min.)
-20°C ... 50°C	-20°C ... 50°C	-20°C ... 50°C	-20°C ... 50°C
Any	Any	Any	Any
-	-	-	-

Description	No. of pos.
Digital IN 24 V from S5-135/155 to S7-400	
6ES5 420-4UA14 on 6ES7 421-1BL01-0AA0	①
6ES5 430-4UA14 on 6ES7 421-1BL01-0AA0	②
6ES5 431-4UA12 to 6ES7 421-7DH00-0AB0	③
6ES5 432-4UA12 on 6ES7 421-1BL01-0AA0	④

Ordering data			
Type	Order No.	Pcs. / Pkt.	
FLKM S135/S400/SO120	2301723	1	
FLKM S135/S400/SO121	2301736	1	
FLKM S135-431-4UA/S400	2314846	1	
FLKM S135/S400/SO122	2301749	1	

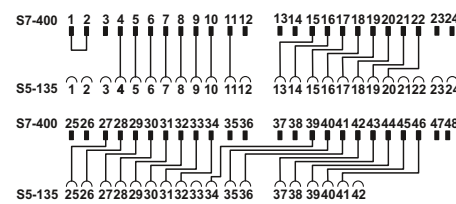

FLKM S135-431-UA/S400 connection scheme

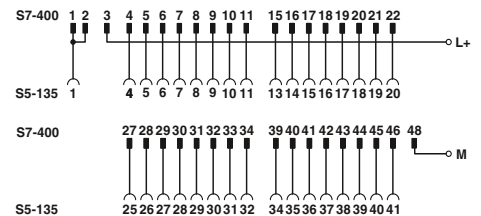

Connection scheme: FLKM S135/S400/SO120

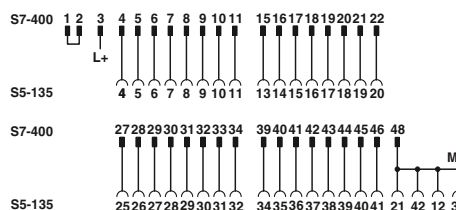

Connection scheme: FLKM S135/S400/SO122

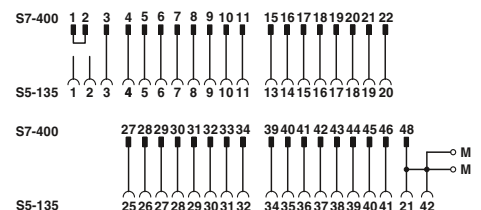

Connection scheme: FLKM S135/S400/SO121

System cabling for controllers

VARIOFACE system cabling

Siemens SIMATIC® S7-400 Adapter for conversion from S5-135/155 to S7-400

The FLKM S135/... adapters connect a SIMATIC® S5 connector wired with individual conductors directly to the SIMATIC® S7-400 basic card.

The SIMATIC® S5 connector is plugged directly onto an S7-400-I/O card to the help of an FFLKM S135/... intermediate adapter.

A new SIMATIC® S7-400 is installed in place of the SIMATIC® S5. The existing field wiring remains intact.

Attention:

The LEDs of the S7-400 module are hidden.



Front adapter for SIMATIC S5-135/S7-400



Max. perm. operating voltage	Max. permissible current	Test voltage (contact/contact)	Ambient temperature (operation)	Mounting position	Standards/regulations
------------------------------	--------------------------	--------------------------------	---------------------------------	-------------------	-----------------------

Technical data			
①	②	③	④
230 V AC/DC	24 V AC/DC	24 V DC	24 V DC
4 A (per path)	4 A (per path)	4 A (per path)	4 A (per path)
1.5 kV (50 Hz, 1 min.)	500 V (50 Hz, 1 min.)	1.25 kV (50 Hz, 1 min.)	500 V (50 Hz, 1 min.)
-20°C ... 50°C	-20°C ... 50°C	-20°C ... 50°C	-20°C ... 50°C
Any	Any	Any	Any
-	-	-	-

Description	No. of pos.
Digital IN 120/230 V UC from S5-135/155 to S7-400	
6ES5 436-4UA12 to 6ES7 421-1FH20-0AA0	①
Digital OUT 24 V from S5-135/155 to S7-400	
6ES5 441-4UA12 to 6ES7 422-1BL00-0AA0	②
6ES5 451-4UA14 to 6ES7 422-1BL00-0AA0	③
Digital OUT 24 V DC / 2 A from S5-135/155 to S7-400	
6ES5 453-4UA12 to 6ES7 422-1HH00-0AA0	④

Ordering data			
Type	Order No.	Pcs. / Pkt.	
FLKM S135/S400/SO123	2301752	1	
FLKM S135/S400/SO125	2301778	1	
FLKM S135/S400/SO126	2301781	1	
FLKM S135/S400/SO127	2301794	1	

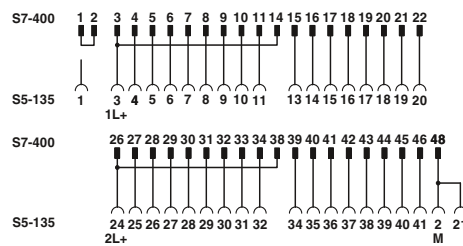

Connection scheme: FLKM S135/S400/SO126

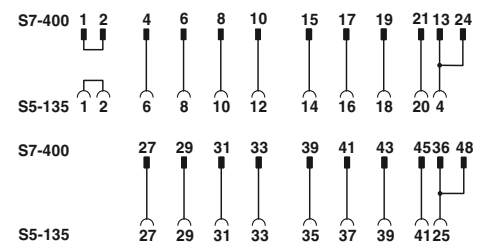

Connection scheme: FLKM S135/S400/SO123

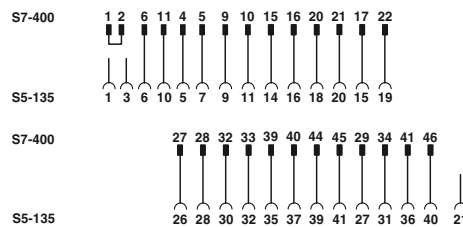

Connection scheme: FLKM S135/S400/SO127

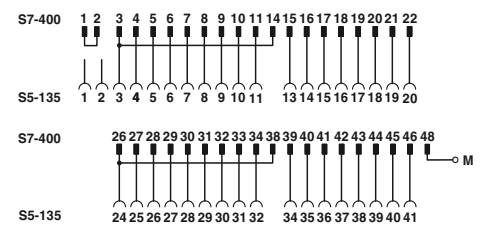

Connection scheme: FLKM S135/S400/SO125

Siemens SIMATIC® S7-400 Adapter for conversion from S5-135/155 to S7-400

The FLKM S135/... adapters connect a SIMATIC® S5 connector wired with individual conductors directly to the SIMATIC® S7-400 basic card.

The SIMATIC® S5 connector is plugged directly onto an S7-400-I/O card to the help of an FFLKM S135/... intermediate adapter.

A new SIMATIC® S7-400 is installed in place of the SIMATIC® S5. The existing field wiring remains intact.

Attention:

The LEDs of the S7-400 module are hidden.



Adapter for Siemens SIMATIC® S5-135/S7-400

Max. perm. operating voltage	24 V DC
Max. permissible current	4 A (per path)
Test voltage (contact/contact)	1.25 kV (50 Hz, 1 min.)
Ambient temperature (operation)	-20°C ... 50°C
Mounting position	Vertical
Standards/regulations	-

Technical data			
①	②	③	④
24 V DC	230 V AC	24 V DC	24 V DC
4 A (per path)	4 A (per path)	4 A (per path)	4 A (per path)
1.25 kV (50 Hz, 1 min.)	1.5 kV (50 Hz, 1 min.)	500 V (50 Hz, 1 min.)	500 V (50 Hz, 1 min.)
-20°C ... 50°C	-20°C ... 50°C	-20°C ... 50°C	-20°C ... 50°C
Vertical	Vertical	Vertical	Vertical
-	-	-	-

Description	No. of pos.
Digital OUT 24 V DC / 2 A from S5-135/155 to S7-400	
6ES5 454-4UA14 to 6ES7 422-1BH11-0AA0	①
Digital OUT 230 V UC / 2 A from S5-135/155 to S7-400	
6ES5 456-4UA12 to 6ES7 422-1FH00-0AA0	②
Analog IN (only current measurement) from S5-135/155 to S7-400	
6ES5 460-4UA13 to 6ES7 431-1KF00-0AB0	③
Analog IN (only voltage measurement) from S5-135/155 to S7-400	
6ES5 460-4UA13 to 6ES7 431-1KF00-0AB0	④

Ordering data		
Type	Order No.	Pcs. / Pkt.
FLKM S135-454-4UA/S400	2314859	1
FLKM S135/S400/SO124	2301765	1
FLKM S135-460-4UA/I/S400	2314613	1
FLKM S135-460-4UA/U/S400	2314862	1

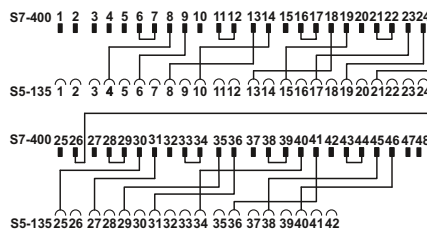

FLKM S135-460-4UA/I/S400 connection scheme

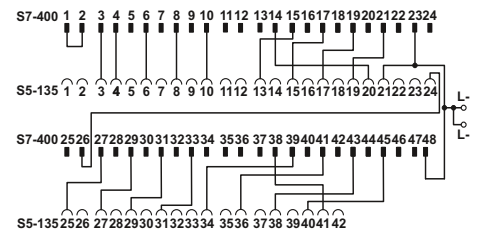

FLKM S135-454-4UA/S400 connection scheme

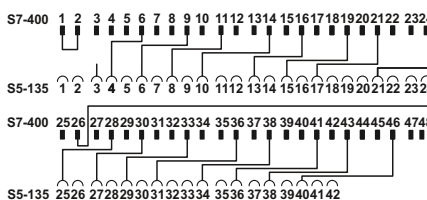

Connection scheme: FLKM S135-460-4UA/U/S400

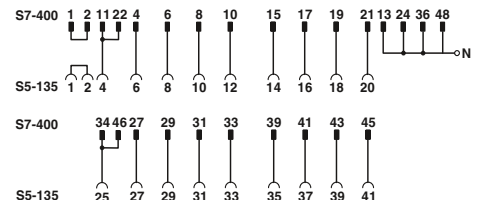

Connection scheme: FLKM S135/S400/SO124

System cabling for controllers

VARIOFACE system cabling

Siemens SIMATIC® S7-400 Adapter for conversion from S5-135/155 to S7-400

The FLKM S135/... adapters connect a SIMATIC® S5 connector wired with individual conductors directly to the SIMATIC® S7-400 basic card.

The SIMATIC® S5 connector is plugged directly onto an S7-400-I/O card to the help of an FFLKM S135/... intermediate adapter.

A new SIMATIC® S7-400 is installed in place of the SIMATIC® S5. The existing field wiring remains intact.

Attention:

The LEDs of the S7-400 module are hidden.



Adapter for Siemens SIMATIC® S5-135/S7-400



Max. perm. operating voltage	24 V DC
Max. permissible current	2 A (per path)
Test voltage (contact/contact)	500 V (50 Hz, 1 min.)
Ambient temperature (operation)	-20°C ... 50°C
Mounting position	Any
Standards/regulations	-

Technical data			
①	②	③	④
24 V DC	24 V DC	24 V DC	24 V DC
2 A (per path)	4 A (per path)	4 A (per path)	4 A (per path)
500 V (50 Hz, 1 min.)	500 V (50 Hz, 1 min.)	500 V (50 Hz, 1 min.)	500 V (50 Hz, 1 min.)
-20°C ... 50°C	-20°C ... 50°C	-20°C ... 50°C	-20°C ... 50°C
Any	Any	Any	Any
-	-	-	-

Description	No. of pos.
Analog IN (only Pt 100) from S5-135/155 to S7-400	
6ES5 465-4UA13 to 6ES7 431-7KF10-0AB0	①
Analog IN (only current and voltage measurement) from S5-135/155 to S7-400	
6ES5 465-4UA13 to 6ES7 431-0HH00-0AB0	②
6ES5 465-4UA13 to 6ES7 431-7QH00-0AB0	
Analog OUT (only current output) from S5-135/155 to S7-400	
6ES5 470-4UA13 to 6ES7 432-1HF00-0AB0	③
6ES5 470-4UC13 to 6ES7 432-1HF00-0AB0	
Analog OUT (only voltage output) from S5-135/155 to S7-400	
6ES5 470-4UA13 to 6ES7 432-1HF00-0AB0	④
6ES5 470-4UB13 to 6ES7 432-1HF00-0AB0	
6ES5 470-4UC13 to 6ES7 432-1HF00-0AB0	

Ordering data			
Type	Order No.	Pcs. / Pkt.	
FLKM S135-465-4UA/T/S400	2314875	1	
FLKM S135-465-4UA/UI/S400	2314888	1	
FLKM S135-470-4UC/I/S400	2314626	1	
FLKM S135-470-4UC/U/S400	2314891	1	

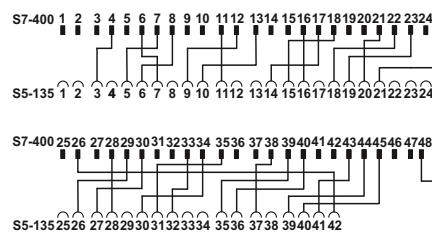

Connection scheme FLKM S135-470-4UC/I/S400

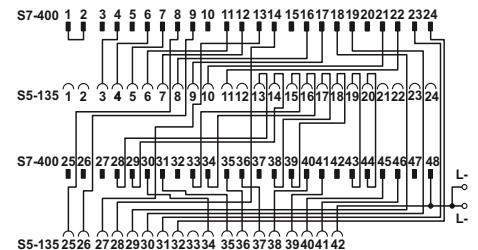

FLKM S135-465-4UA/T/S400 connection scheme

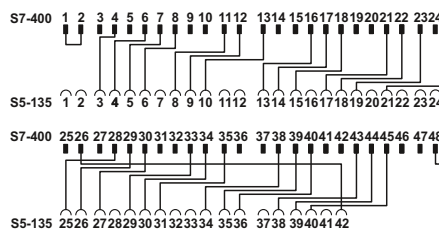

Connection scheme FLKM S135-470-4UC/U/S400

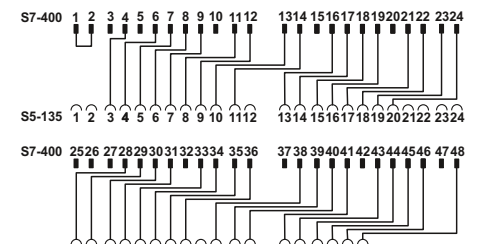

FLKM S135-465-4UA/UI/S400 connection scheme

**Siemens SIMATIC® S7-300
Adapter for conversion from
S5-135/155 to S7-300**

S5-S7 adapters connect the S5-135 front adapters wired with individual wires to the I/O modules of the S7.

With the help of the FLKM S135/S7/FLK50 converter module, the signals of the S5-135 front adapter can be converted to a 50-pos. strip. A 50-pos. system cable FLK 50/EZ-DR/.../KONFEK and a front adapter for the SIMATIC® S7 (FLKM 50-PA-S300) now connect the signals with the I/O module.



Max. perm. operating voltage
Max. permissible current
Ambient temperature (operation)
Ambient temperature (storage/transport)
Mounting position
Standards/regulations

**Converter for Siemens SIMATIC® S5-135 to
50-pos. FLK strip.**

Technical data

50 V AC/DC
1 A (per path)
-20°C ... 50°C
-20°C ... 70°C
Any
DIN EN 50178 / DIN EN 50178

Ordering data

Description
Digital IN or OUT 24 V DC from S5-135 to S7-300
IN 6ES5 420-4UA14 to 6ES7 321-1BL00-0AA0 6ES5 430-4UA14 to 6ES7 321-1BL00-0AA0
OUT 6ES5 441-4UA14 to 6ES7 322-1BL00-0AA0 6ES5 451-4UA14 to 6ES7 322-1BL00-0AA0

Type	Order No.	Pcs. / Pkt.
FLKM S135/S7/FLK50/PLC	2314736	1

Notes:
Due to the geometry, it is not possible to couple any molded FLK connectors (e.g., VIP-PA...S7).

**Startup adapter for extending the
existing S5-135/155 field wiring.**

All signals of the existing S5-135 wiring 3 or 5 are extended with the help of the universal commissioning adapters. The open cable end can be connected to various controllers such as S7-400 or S7-300. This means that the existing field wiring of S5-135 can communicate with the new controller for test purposes. Since the new control unit is temporarily arranged before the control cabinet, the original status of the system can be restored if required.

If the system functions with the new controller without problems, the S5-135 can now be replaced.



Max. perm. operating voltage
Max. permissible current
Ambient temperature (operation)
Ambient temperature (storage/transport)
Mounting position
Standards/regulations

Technical data

250 V AC/DC
6 A (per path)
-20°C ... 50°C
-20°C ... 80°C
Any
EN 60664-1

Ordering data

Description
Connection of all S5-135 connections (1 to 42) at the open cable end

Type	Order No.	Pcs. / Pkt.
FLKM S135/42X0,75/3,0M/OE	2315007	1
FLKM S135/42X0,75/5,0M/OE	2318017	1



VARIOFACE system cabling

Siemens SIMATIC® S7-400 Adapter for conversion from S5-115 to S7-400

The FLKM S115/... adapters connect a SIMATIC® S5 connector wired with individual conductors directly to the SIMATIC® S7-400 basic card.

The SIMATIC® S5 connector is plugged directly onto an S7-400-I/O card to the help of an FFLKM S115/... intermediate adapter.

A new SIMATIC® S7-400 is installed in place of the SIMATIC® S5. The existing field wiring remains intact.

Attention:

Due to the geometry, it is only possible to use every second slot. The LEDs of the S7-400 module are hidden by the S5-115 adapter.



Adapter for Siemens SIMATIC® S5-115/S7-400

Max. perm. operating voltage
Max. permissible current

Ambient temperature (operation)
Ambient temperature (storage/transport)
Mounting position
Standards/regulations

24 V AC/DC
4 A (per path)
4 A (per connection, supply via separate power supply)

-20°C ... 50°C
-20°C ... 70°C
Vertical
DIN EN 50178 / DIN EN 50178

Technical data

Ordering data

Description
Digital IN or OUT 24 V DC from S5-115 to S7-400
IN 6ES5 420-7LA11 to 6ES7 421-1BL01-0AA0 6ES5 430-7LA11 to 6ES7 421-1BL01-0AA0
OUT 6ES5 441-7LA11 to 6ES7 422-1BL00-0AA0 6ES5 451-7LA11 to 6ES7 422-1BL00-0AA0
Digital OUT 24 V DC from S5-115 to S7-400
6ES5 454-7LA12 to 6ES7 422-1BH11-0AA0
Analog IN (only current and voltage measurement) from S5-115 to S7-400
6ES5 465-7LA13 to 6ES7 431-0HH00-0AB0 6ES5 465-7LA13 to 6ES7 431-7QH00-0AB0

Type	Order No.	Pcs. / Pkt.
FLKM S115/S400/SO155	2307248	1
FLKM S115-454-7LA/S400	2314901	1
FLKM S115-465-7LA/UI/S400	2314914	1

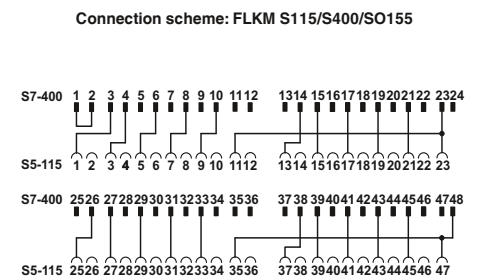
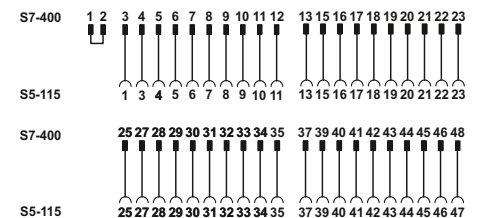

**Siemens SIMATIC® S7-300
Adapter for conversion from
S5-115 to S7-300**

S5-S7 adapters connect the S5-115 front adapters wired with individual wires to the I/O modules of S7-300.

With the aid of the FLKM S115/S7/FLK50/SO137 converter module, the signals of the S5-115 front adapter can be converted to a 50-pos. strip. A 50-pos. system cable FLK 50/EZ-DR/.../KONFEK and a front adapter for the SIMATIC® S7 (FLKM 50-PA-S300) now connect the signals with the I/O module.

Notes:
Due to the geometry, it is not possible to couple any molded FLK connectors (e.g., VIP-PA...S7).



Connection scheme: FLKM S115/S7/FLK50/PLC/SO137

Max. perm. operating voltage
Max. permissible current
Max. perm. total current
Ambient temperature (operation)
Ambient temperature (storage/transport)
Standards/regulations



Converter for Siemens SIMATIC® S5-115 to 50-pos. FLK strip.

Technical data

24 V AC/DC
1 A (per path)
2 A (per byte)
-20°C ... 50°C
-20°C ... 70°C
DIN EN 50178 / DIN EN 50178

Ordering data

Type	Order No.	Pcs. / Pkt.
FLKM S115/S7/FLK50/PLC/SO137	2306294	1

Description
Digital IN or OUT 24 V DC from S5-115 through converters, system cables, and front adapters to S7-300
IN 6ES5 420-7LA11 on 6ES7 321-1BL00-0AA0 6ES5 430-7LA11 on 6ES7 321-1BL00-0AA0
OUT 6ES5 441-7LA11 on 6ES7 322-1BL00-0AA0 6ES5 451-7LA11 on 6ES7 322-1BL00-0AA0

Commissioning adapters for extending the existing S5-115 field wiring

All signals of the existing S5-115 wiring 3 or 5 are extended with the help of the universal commissioning adapters. The open cable end can be connected to various controllers such as S7-400 or S7-300. This means that the existing field wiring of S5-115 can communicate with the new controller for test purposes. Since the new control unit is temporarily arranged before the control cabinet, the original status of the system can be restored if required.

If the system functions with the new controller without problems, the S5-115 can now be replaced.



Max. perm. operating voltage
Max. permissible current
Ambient temperature (operation)
Ambient temperature (storage/transport)
Mounting position
Standards/regulations



Technical data

250 V AC/DC
6 A (per path)
-20°C ... 50°C
-20°C ... 80°C
Any
EN 60664-1

Ordering data

Type	Order No.	Pcs. / Pkt.
FLKM S115/47X0,75/3,0M/OE	2314985	1
FLKM S115/47X0,75/5,0M/OE	2314998	1

Description
Connection of all S5-115 connections (1 to 23, 25 to 47) at the open cable end

System cabling for controllers

VARIOFACE system cabling

YOKOGAWA Centum CS3000 R3 System cable

These shielded system cables for digital (50-pos.) and analog (40-pos.) I/O modules are connected directly to the modules. An intermediate adapter is not required. Features:

- Molded plug-in connector
- Can be screwed
- Lateral cable outlet of the I/O module
- KS/AKB-compatible plug-in connectors on the module side



			Technical data		
Max. perm. operating voltage			30 V DC		
Max. perm. current carrying capacity per path			500 mA		
Max. conductor resistance			0.16 Ω/m		
Ambient temperature (operation)			-20°C ... 50°C		
Conductor cross section			AWG 26 / 0.14 mm ²		
Conductor structure: stranded wires / material			7 / Cu tin-plated		
Outside diameter					
	50 -position		11 mm		
	40 -position		11 mm		
			Ordering data		
Description	No. of pos.	Cable length	Type	Order No.	Pcs. / Pkt.
50-pos. YUC cables, for digital I/O modules					
	50	2 m	FLK 50-PA/EZ-DR/KS/ 200/YUC	2314299	1
	50	3 m	FLK 50-PA/EZ-DR/KS/ 300/YUC	2314309	1
	50	4 m	FLK 50-PA/EZ-DR/KS/ 400/YUC	2314312	1
	50	5 m	FLK 50-PA/EZ-DR/KS/ 500/YUC	2321499	1
	50	6 m	FLK 50-PA/EZ-DR/KS/ 600/YUC	2314927	1
	50	7 m	FLK 50-PA/EZ-DR/KS/ 700/YUC	2321509	1
	50	8 m	FLK 50-PA/EZ-DR/KS/ 800/YUC	2314930	1
	50	9 m	FLK 50-PA/EZ-DR/KS/ 900/YUC	2321512	1
	50	10 m	FLK 50-PA/EZ-DR/KS/1000/YUC	2314325	1
	50	11 m	FLK 50-PA/EZ-DR/KS/1100/YUC	2321389	1
	50	12 m	FLK 50-PA/EZ-DR/KS/1200/YUC	2321525	1
	50	13 m	FLK 50-PA/EZ-DR/KS/1300/YUC	2321392	1
	50	14 m	FLK 50-PA/EZ-DR/KS/1400/YUC	2321402	1
	50	15 m	FLK 50-PA/EZ-DR/KS/1500/YUC	2314338	1
	50	16 m	FLK 50-PA/EZ-DR/KS/1600/YUC	2321538	1
	50	17 m	FLK 50-PA/EZ-DR/KS/1700/YUC	2321541	1
	50	18 m	FLK 50-PA/EZ-DR/KS/1800/YUC	2321554	1
	50	19 m	FLK 50-PA/EZ-DR/KS/1900/YUC	2321567	1
	50	20 m	FLK 50-PA/EZ-DR/KS/2000/YUC	2314503	1
	50	25 m	FLK 50-PA/EZ-DR/KS/2500/YUC	2314516	1
	50	30 m	FLK 50-PA/EZ-DR/KS/3000/YUC	2314529	1
40-pos. YUC cables, for analog I/O modules					
	40	1 m	FLK 40-PA/EZ-DR/KS/ 100/YUC	2322786	1
	40	2 m	FLK 40-PA/EZ-DR/KS/ 200/YUC	2314341	1
	40	3 m	FLK 40-PA/EZ-DR/KS/ 300/YUC	2314354	1
	40	4 m	FLK 40-PA/EZ-DR/KS/ 400/YUC	2314367	1
	40	5 m	FLK 40-PA/EZ-DR/KS/ 500/YUC	2321570	1
	40	6 m	FLK 40-PA/EZ-DR/KS/ 600/YUC	2314943	1
	40	7 m	FLK 40-PA/EZ-DR/KS/ 700/YUC	2321583	1
	40	8 m	FLK 40-PA/EZ-DR/KS/ 800/YUC	2314956	1
	40	9 m	FLK 40-PA/EZ-DR/KS/ 900/YUC	2321415	1
	40	10 m	FLK 40-PA/EZ-DR/KS/1000/YUC	2314370	1
	40	11 m	FLK 40-PA/EZ-DR/KS/1100/YUC	2321428	1
	40	12 m	FLK 40-PA/EZ-DR/KS/1200/YUC	2321431	1
	40	13 m	FLK 40-PA/EZ-DR/KS/1300/YUC	2321444	1
	40	14 m	FLK 40-PA/EZ-DR/KS/1400/YUC	2321457	1
	40	15 m	FLK 40-PA/EZ-DR/KS/1500/YUC	2314383	1
	40	16 m	FLK 40-PA/EZ-DR/KS/1600/YUC	2321596	1
	40	17 m	FLK 40-PA/EZ-DR/KS/1700/YUC	2321606	1
	40	18 m	FLK 40-PA/EZ-DR/KS/1800/YUC	2321619	1
	40	19 m	FLK 40-PA/EZ-DR/KS/1900/YUC	2321622	1
	40	20 m	FLK 40-PA/EZ-DR/KS/2000/YUC	2314532	1
	40	25 m	FLK 40-PA/EZ-DR/KS/2500/YUC	2314545	1
	40	30 m	FLK 40-PA/EZ-DR/KS/3000/YUC	2314558	1

YOKOGAWA Centum CS3000 R3 System cable

These system cables for digital I/O modules are connected directly to the modules. An intermediate adapter is not required.

Features:

- Lateral cable outlet of the I/O module
- Four 14-pos. plug-in connectors on the module side for connection of four 8-channel VARIOFACE modules of the system cabling



		Technical data	
Max. perm. operating voltage		30 V DC	
Max. perm. current carrying capacity per path		500 mA	
Max. conductor resistance		0.16 Ω/m	
Ambient temperature (operation)		-20°C ... 50°C	
Conductor cross section		AWG 26 / 0.14 mm ²	
Outside diameter	50 -position	11 mm	

			Ordering data		
Description	No. of pos.	Cable length	Type	Order No.	Pcs. / Pkt.
System cable for digital I/O modules for coupling four 8-channel VARIOFACE modules					
	50	2 m	CABLE-50/4FLK14/ 2,0M/YUC	2314655	1
	50	4 m	CABLE-50/4FLK14/ 4,0M/YUC	2314671	1
	50	6 m	CABLE-50/4FLK14/ 6,0M/YUC	2318978	1
	50	10 m	CABLE-50/4FLK14/10,0M/YUC	2314684	1
	50	15 m	CABLE-50/4FLK14/15,0M/YUC	2322773	1
	50	20 m	CABLE-50/4FLK14/20,0M/YUC	2314778	1

YOKOGAWA Centum CS3000 R3 System cable for MINI analog system cabling

The Yokogawa **CABLE-40/2FLK16/.../YUC** system cable makes it possible to connect 16 MINI analog modules to a Yokogawa control system. In conjunction with two MINI analog MINI MCR-SL-V8-FLK-16-A system adapters, the Yokogawa system cable provides a simple and economical “Plug and Play” solution.

The system cable is plugged directly into the Yokogawa module. Two 16-pos. flat-ribbon cable plug-in connectors are provided for connecting the module to the MINI analog system adapters.

The system cable in conjunction with **4-conductor measuring transducers** is suitable for the following analog cards:

- AAI 141
- AAI 143



		Technical data	
Max. perm. operating voltage		30 V DC	
Max. perm. current carrying capacity per path		500 mA	
Max. conductor resistance		0.16 Ω/m	
Ambient temperature (operation)		-20°C ... 50°C	
Conductor cross section		AWG 26 / 0.14 mm ²	
Conductor structure: stranded wires / material		7 / Cu tin-plated	
Outside diameter	40 -position	11 mm	

			Ordering data		
Description	No. of pos.	Cable length	Type	Order No.	Pcs. / Pkt.
System cable , for analog I/O modules for coupling two 8-channel MINI analog system adapters					
	40	2 m	CABLE-40/2FLK16/ 2,0M/YUC	2321334	1
	40	4 m	CABLE-40/2FLK16/ 4,0M/YUC	2321347	1
	40	10 m	CABLE-40/2FLK16/10,0M/YUC	2321350	1
	40	15 m	CABLE-40/2FLK16/15,0M/YUC	2321376	1
	40	20 m	CABLE-40/2FLK16/20,0M/YUC	2321363	1

System cabling for controllers

VARIOFACE system cabling

YOKOGAWA Centum CS3000 R3 Controller boards

These modules are connected to the I/O modules through the YUC system cable.

FLKM-KS40/YCS:

- For analog modules
- Universal interface module with 40 connection terminal blocks

For more cabling solutions for Yokogawa:
www.phoenixcontact.com



Passive interface modules

Technical data

Max. perm. operating voltage	24 V AC/DC ±10%
Max. perm. current (per branch)	1 A
Test voltage (contact/contact)	500 V (50 Hz, 1 min.)
Ambient temperature (operation)	-20°C ... 50°C
Mounting position	Any
Standards/regulations	DIN EN 50178,
Connection method	Screw connection
	Field level
	Control system level
Connection data solid / stranded / AWG	Yokogawa KS-compatible 0.2 ... 4 mm ² / 0.2 ... 2.5 mm ² / 24 - 12
Dimensions	H / D 90 mm / 68 mm

Ordering data

Description	No. of pos.	Module width W	Type	Order No.	Pcs. / Pkt.
Controller board, for analog I/O modules	40	112 mm	FLKM-KS40/YCS	2314642	1

YOKOGAWA Centum CS3000 R3 Controller boards

These modules are connected to the I/O modules through the YUC system cable.

FLKMS-KS50/32IM/YCS:

- For digital modules ADV 151 and ADV 551
- Three-conductor connection (signal, plus, minus)
- Redundant voltage supply (fuse IEC 127-2, 5 x 20, 2 A)

For more cabling solutions for Yokogawa:
www.phoenixcontact.com



Passive interface modules

Technical data

Max. perm. operating voltage	24 V AC/DC ±10%
Max. perm. current (per branch)	1 A
Test voltage (contact/contact)	500 V (50 Hz, 1 min.)
Ambient temperature (operation)	-20°C ... 50°C
Mounting position	Any
Standards/regulations	DIN EN 50178,
Connection method	Screw connection
	Field level
	Control system level
Connection data solid / stranded / AWG	Yokogawa KS-compatible 0.2 ... 4 mm ² / 0.2 ... 2.5 mm ² / 24 - 12
Dimensions	H / D 90 mm / 81 mm

Ordering data

Description	No. of pos.	Module width W	Type	Order No.	Pcs. / Pkt.
Controller board, for digital I/O modules ADV 151 and ADV 551	50	174 mm	FLKMS-KS50/32IM/YCS	2314451	1

YOKOGAWA Centum CS3000 R3 Controller boards

These modules are connected to the analog I/O modules through the 40-pos. YUC system cable.

The modules are designed for redundant signal transmission (two plug-in connectors in parallel). A separate connection to the HART multiplexer is possible.

FLKM-KS40/AO16/YCS

– For analog module AAI 543

FLKMS-KS40/SI/AI16/YCS

– For analog modules AAI 141 and AAI 143 (operation of modules in the 4-conductor mode)

- Transfer of 16 channels with separate positive and negative connections
- 16 plug-in fuses (IEC 127-2, 5 x 20, 0.1 A) per positive supply and LED status indicator
- Redundant voltage supply (fuse IEC 127-2, 5 x 20, 2 A)

FLKMS-KS40/AI/YCS

– For analog modules AAI 141 and AAI 143 (operation of modules in the 4-conductor mode)

- Transfer of 16 channels with separate positive and negative connections
- Redundant voltage supply (fuse IEC 127-2, 5 x 20, 2 A)

For more cabling solutions for Yokogawa:
www.phoenixcontact.com



Interface modules for analog I/O modules

Technical data	
Max. perm. operating voltage	24 V DC ±10%
Max. perm. current (per branch)	100 mA
Test voltage (contact/contact)	500 V (50 Hz, 1 min.)
Ambient temperature (operation)	-20°C ... 50°C
Mounting position	Any
Standards/regulations	DIN EN 50178,
Connection method	Screw connection
	Field level
	Control system level
Connection data solid / stranded / AWG	Yokogawa KS-compatible
Dimensions	0.2 ... 4 mm ² / 0.2 ... 2.5 mm ² / 24 - 12
	126 mm / 68 mm

Description	No. of pos.	Module width W
Controller board , for analog output modules AAI 543	40	108 mm
Controller board , with fuses and LED, for analog input modules AAI 141 and AAI 143	40	214 mm
Controller board , for analog input modules AAI 141 and AAI 143, without fuses and LED	40	214 mm

Ordering data		
Type	Order No.	Pcs. / Pkt.
FLKM-KS40/AO16/YCS	2314260	1
FLKMS-KS40/SI/AI16/YCS	2314273	1
FLKMS-KS40/AI/YCS	2314286	1

System cabling for controllers

VARIOFACE system cabling

VIP termination boards for 8 channels

These VIP - VARIOFACE Professional modules are used in combination with 14-pos. system cables and the relevant front adapters.

Features:

- Byte-wise labeling
- For digital I/O modules
- Optionally with LED.

Notes:
For marking systems (e.g., "ZB 22:UNBEDRUCKT"; Order No. 0811862) and mounting material, see Catalog 5.



Passive interface modules for input/output with screw connection



Passive interface modules for input/output with push-in connection



Max. perm. operating voltage	
Max. perm. current (per branch)	
Max total current (voltage supply)	
Rated surge voltage	
Ambient temperature (operation)	
Mounting position	
Standards/regulations	
Connection method	Field level
	Control system level
Connection data solid / stranded / AWG	
Dimensions	H / D

Technical data	
VIP-2/.../FLK14/PLC	VIP-2/.../FLK14/LED/PLC
60 V AC/DC	24 V DC
1 A	1 A
3 A	3 A
0.6 kV	0.6 kV
-20°C ... 50°C	-20°C ... 50°C
Any	Any
IEC 60664, DIN EN 50178, IEC 62103	IEC 60664, DIN EN 50178, IEC 62103
Screw connection	Screw connection
IDC/FLK pin strip (2.54 mm)	IDC/FLK pin strip (2.54 mm)
0.2 ... 4 mm ² / 0.2 ... 2.5 mm ² / 24 - 12	0.14 ... 2.5 mm ² / 0.14 ... 2.5 mm ² / 26 - 14
65.5 mm / 56 mm	72.1 mm / 56 mm

Technical data	
VIP-2/.../FLK14/PLC	VIP-2/.../FLK14/LED/PLC
60 V AC/DC	24 V DC
1 A	1 A
3 A	3 A
0.6 kV	0.6 kV
-20°C ... 50°C	-20°C ... 50°C
Any	Any
IEC 60664, DIN EN 50178, IEC 62103	IEC 60664, DIN EN 50178, IEC 62103
Push-in connection	Push-in connection
IDC/FLK pin strip (2.54 mm)	IDC/FLK pin strip (2.54 mm)
0.14 ... 2.5 mm ² / 0.14 ... 2.5 mm ² / 26 - 14	0.14 ... 2.5 mm ² / 0.14 ... 2.5 mm ² / 26 - 14
72.1 mm / 56 mm	72.1 mm / 56 mm

Description	No. of pos.	Module width W
VARIOFACE interface module , for eight channels,		
- with screw connection	14	39.8 mm
- with push-in connection	14	41.9 mm
VARIOFACE interface module , for eight channels with light indicator,		
- with screw connection	14	39.8 mm
- with push-in connection	14	41.9 mm

Ordering data		
Type	Order No.	Pcs. / Pkt.
VIP-2/SC/FLK14/PLC	2315214	1
VIP-2/SC/FLK14/LED/PLC	2322249	1

Ordering data		
Type	Order No.	Pcs. / Pkt.
VIP-2/PT/FLK14/PLC	2903801	1
VIP-2/PT/FLK14/LED/PLC	2904279	1

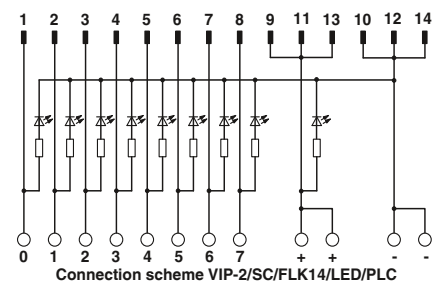
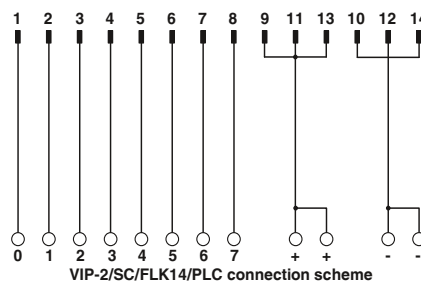

VIP termination boards for 32 channels

These VIP - VARIOFACE Professional modules are used in combination with 50-pos. system cables and the relevant front adapters.

Features:

- Byte-wise labeling
- For digital I/O modules
- Optionally with LED.

Notes:
For marking systems (e.g., "ZB 22:UNBEDRUCKT"; Order No. 0811862) and mounting material, see Catalog 5.

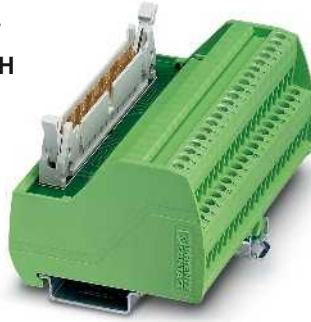

Passive interface modules for input/output with screw connection

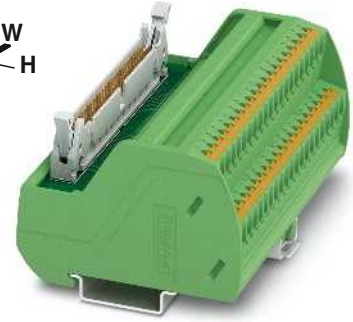

Passive interface modules for input/output with push-in connection



Max. perm. operating voltage	
Max. perm. current (per branch)	
Max total current (voltage supply)	
Rated surge voltage	
Ambient temperature (operation)	
Mounting position	
Standards/regulations	
Connection method	Field level
	Control system level
Connection data solid / stranded / AWG	
Dimensions	H / D

Technical data	
VIP-2/.../FLK50/PLC	VIP-2/.../FLK50/LED/PLC
60 V AC/DC	24 V DC
1 A	1 A
2 A (per byte)	2 A (per byte)
0.6 kV	0.6 kV
-20°C ... 50°C	-20°C ... 50°C
Any	Any
IEC 60664, DIN EN 50178, IEC 62103	IEC 60664, DIN EN 50178, IEC 62103
Screw connection	Screw connection
IDC/FLK pin strip (2.54 mm)	IDC/FLK pin strip (2.54 mm)
0.2 ... 4 mm ² / 0.2 ... 2.5 mm ² / 24 - 12	
65.5 mm / 56 mm	

Technical data	
VIP-2/.../FLK50/PLC	VIP-2/.../FLK50/LED/PLC
60 V AC/DC	24 V DC
1 A	1 A
2 A (per byte)	2 A (per byte)
0.6 kV	0.6 kV
-20°C ... 50°C	-20°C ... 50°C
Any	Any
IEC 60664, DIN EN 50178, IEC 62103	IEC 60664, DIN EN 50178, IEC 62103
Push-in connection	Push-in connection
IDC/FLK pin strip (2.54 mm)	IDC/FLK pin strip (2.54 mm)
0.14 ... 2.5 mm ² / 0.14 ... 2.5 mm ² / 26 - 14	
72.1 mm / 56 mm	

Description	No. of pos.	Module width W
VARIOFACE interface module, for 32 channels,		
- with screw connection	50	106.1 mm
- with push-in connection	50	107.9 mm
VARIOFACE interface module, for 32 channels with light indicator,		
- with screw connection	50	106.1 mm
- with push-in connection	50	107.9 mm

Ordering data		
Type	Order No.	Pcs. / Pkt.
VIP-2/SC/FLK50/PLC	2315227	1
VIP-2/SC/FLK50/LED/PLC	2322252	1

Ordering data		
Type	Order No.	Pcs. / Pkt.
VIP-2/PT/FLK50/PLC	2903803	1
VIP-2/PT/FLK50/LED/PLC	2904280	1

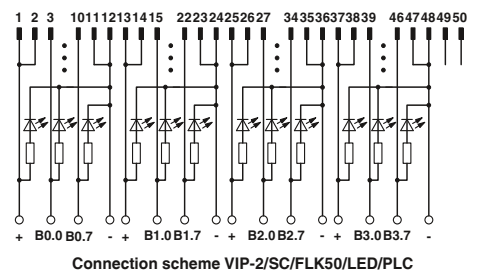
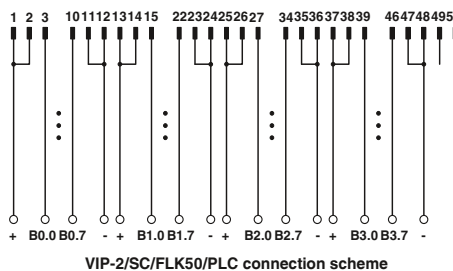

System cabling for controllers

VARIOFACE system cabling

VIP termination boards for SIMATIC® S7

These VIP - VARIOFACE Professional modules are used in combination with 50-pos. system cables and the relevant front adapters for SIMATIC® S7.

Features:

- Numerical marking
- Specifically for S7-300 or S7-400

Notes:
For marking systems (e.g., "ZB 22:UNBEDRUCKT"; Order No. 0811862) and mounting material, see Catalog 5.

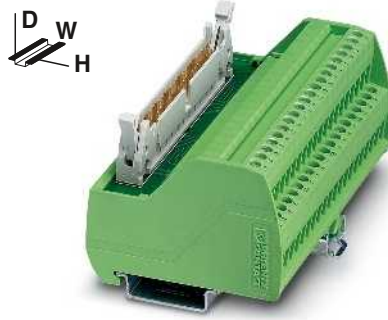

Passive interface modules for input/output, with SIMATIC®-specific marking and screw connection

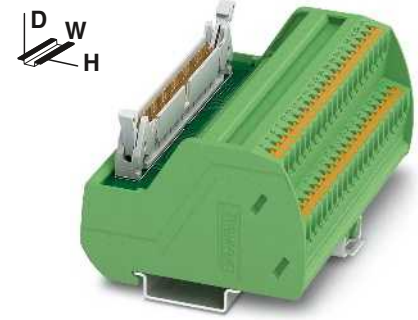

Passive interface modules for input/output, with SIMATIC®-specific marking and push-in connection

N



Max. perm. operating voltage	60 V AC/DC
Max. perm. current (per branch)	1 A
Rated surge voltage	0.6 kV
Ambient temperature (operation)	-20°C ... 50°C
Mounting position	Any
Standards/regulations	IEC 60664, DIN EN 50178, IEC 62103
Connection method	Screw connection
	Field level
	Control system level
Connection data solid / stranded / AWG	0.2 ... 4 mm ² / 0.2 ... 2.5 mm ² / 24 - 12
Dimensions	65.5 mm / 56 mm

Technical data

Technical data

Max. perm. operating voltage	60 V AC/DC
Max. perm. current (per branch)	1 A
Rated surge voltage	0.6 kV
Ambient temperature (operation)	-20°C ... 50°C
Mounting position	Any
Standards/regulations	IEC 60664, DIN EN 50178, IEC 62103
Connection method	Push-in connection
	Field level
	Control system level
Connection data solid / stranded / AWG	0.14 ... 2.5 mm ² / 0.14 ... 2.5 mm ² / 26 - 14
Dimensions	72.1 mm / 56 mm

Description	No. of pos.	Module width W
VARIOFACE interface module, with SIMATIC® S7-300-specific marking from 1 to 40		
- with screw connection	50	106.1 mm
- with push-in connection	50	107.9 mm
VARIOFACE interface module, with SIMATIC® S7-400-specific marking from 3 to 48		
- with screw connection	50	106.1 mm
- with push-in connection	50	107.9 mm

Ordering data

Ordering data

Type	Order No.	Pcs. / Pkt.
VIP-2/SC/FLK50 (1-40) /S7	2315243	1
VIP-2/SC/FLK50/S7/A-S400	2322359	1

Type	Order No.	Pcs. / Pkt.
VIP-2/PT/FLK50 (1-40) /S7	2903804	1
VIP-2/PT/FLK50/S7/A-S400	2904289	1

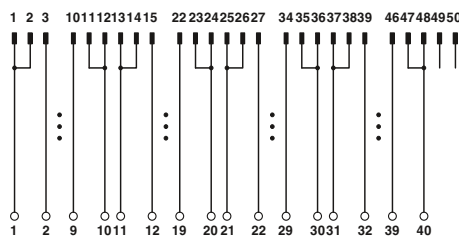

Connection scheme VIP-2/.../FLK50 (1-40) /S7

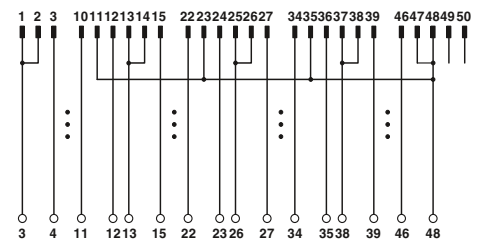

Connection scheme VIP-2/.../FLK50/S7/A-S400

VIP termination boards for MODICON® TSX Quantum and Allen-Bradley ControlLogix

These VIP - VARIOFACE Professional modules are used in combination with 50-pos. system cables and the relevant front adapters.

Features:

- Specific marking
- Specifically for MODICON TSX Quantum or ControlLogix

Notes:
For marking systems (e.g., "ZB 22:UNBEDRUCKT"; Order No. 0811862) and mounting material, see Catalog 5.

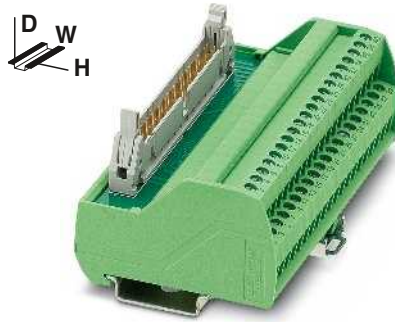

Passive interface modules for input/output, with specific marking and screw connection

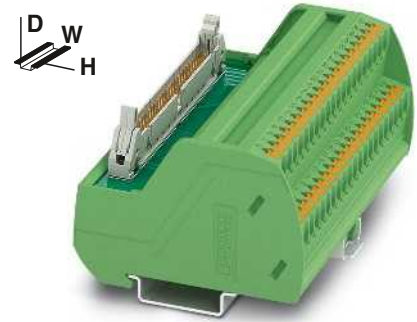

Passive interface modules for input/output, with specific marking and push-in connection



Max. perm. operating voltage	60 V AC/DC
Max. perm. current (per branch)	1 A
Rated surge voltage	0.6 kV
Ambient temperature (operation)	-20°C ... 50°C
Mounting position	Any
Standards/regulations	IEC 60664, DIN EN 50178, IEC 62103
Connection method	Screw connection
	Field level
	Control system level
Connection data solid / stranded / AWG	IDC/FLK pin strip (2.54 mm) 0.2 ... 4 mm ² / 0.2 ... 2.5 mm ² / 24 - 12
Dimensions	65.5 mm / 56 mm

Technical data

Max. perm. operating voltage	60 V AC/DC
Max. perm. current (per branch)	1 A
Rated surge voltage	0.6 kV
Ambient temperature (operation)	-20°C ... 50°C
Mounting position	Any
Standards/regulations	IEC 60664, DIN EN 50178, IEC 62103
Connection method	Push-in connection
	Field level
	Control system level
Connection data solid / stranded / AWG	IDC/FLK pin strip (2.54 mm) 0.14 ... 2.5 mm ² / 0.14 ... 2.5 mm ² / 26 - 14
Dimensions	72.1 mm / 56 mm

Technical data

Max. perm. operating voltage	60 V AC/DC
Max. perm. current (per branch)	1 A
Rated surge voltage	0.6 kV
Ambient temperature (operation)	-20°C ... 50°C
Mounting position	Any
Standards/regulations	IEC 60664, DIN EN 50178, IEC 62103
Connection method	Push-in connection
	Field level
	Control system level
Connection data solid / stranded / AWG	IDC/FLK pin strip (2.54 mm) 0.14 ... 2.5 mm ² / 0.14 ... 2.5 mm ² / 26 - 14
Dimensions	72.1 mm / 56 mm

Description	No. of pos.	Module width W
VARIOFACE interface module, with MODICON® TSX Quantum-specific marking from 1 to 40		
- with screw connection	50	106.1 mm
- with push-in connection	50	107.9 mm
VARIOFACE interface module, with ControlLogix-specific marking from 1 to 36		
- with screw connection	50	95.9 mm
- with push-in connection	50	97.7 mm

Ordering data

Type	Order No.	Pcs. / Pkt.
VIP-2/SC/FLK50/MODI-TSX/Q	2322304	1
VIP-2/SC/FLK50/AB-1756	2322317	1

Ordering data

Type	Order No.	Pcs. / Pkt.
VIP-2/PT/FLK50/MODI-TSX/Q	2904285	1
VIP-2/PT/FLK50/AB-1756	2904286	1

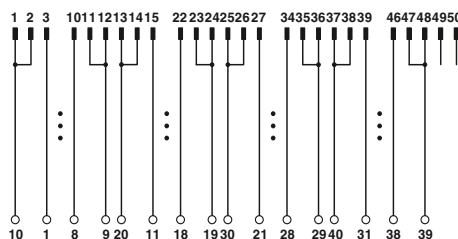

Connection scheme VIP-2/.../FLK50/MODI-TSX/Q

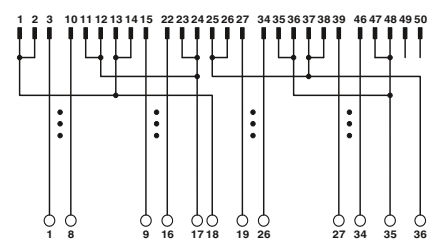

Connection scheme VIP-2/.../FLK50/AB-1756

System cabling for controllers

VARIOFACE system cabling

VIP termination boards for Siemens SIMATIC® S7-300

These VIP - VARIOFACE Professional modules are used in combination with two 14-pos. system cables and the relevant front adapters for Siemens SIMATIC® S7-300.

Features:

- Numerical labeling (1-20)
- Specifically for S7 300.

Notes:
For marking systems (e.g., "ZB 22:UNBEDRUCKT"; Order No, 0811862) and mounting material, see Catalog 5.

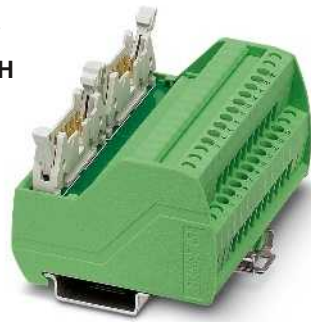

Passive interface modules for SIMATIC® S7-300 with screw connection

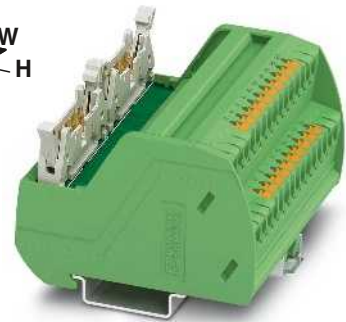

Passive interface modules for SIMATIC® S7-300 with push-in connection

N



Max. perm. operating voltage	
Max. perm. current (per branch)	
Rated surge voltage	
Ambient temperature (operation)	
Mounting position	
Standards/regulations	
Connection method	Field level
	Control system level
Connection data solid / stranded / AWG	
Dimensions	H / D

Technical data	
Max. perm. operating voltage	60 V AC/DC
Max. perm. current (per branch)	1 A
Rated surge voltage	0.6 kV
Ambient temperature (operation)	-20°C ... 50°C
Mounting position	Any
Standards/regulations	IEC 60664, DIN EN 50178, IEC 62103
Connection method	Screw connection
	IDC/FLK pin strip (2.54 mm)
Connection data solid / stranded / AWG	0.2 ... 4 mm ² / 0.2 ... 2.5 mm ² / 24 - 12
Dimensions	65.5 mm / 56 mm

Technical data	
Max. perm. operating voltage	60 V AC/DC
Max. perm. current (per branch)	1 A
Rated surge voltage	0.6 kV
Ambient temperature (operation)	-20°C ... 50°C
Mounting position	Any
Standards/regulations	IEC 60664, DIN EN 50178, IEC 62103
Connection method	Push-in connection
	IDC/FLK pin strip (2.54 mm)
Connection data solid / stranded / AWG	0.14 ... 2.5 mm ² / 0.14 ... 2.5 mm ² / 26 - 14
Dimensions	72.1 mm / 56 mm

Description	No. of pos.	Module width W
VARIOFACE interface module, with SIMATIC® S7-300-specific marking from 1 to 20		
- with screw connection	14	80.6 mm
- with push-in connection	14	82.5 mm

Ordering data		
Type	Order No.	Pcs. / Pkt.
VIP-2/SC/2FLK14 (1-20) /S7	2315230	1

Ordering data		
Type	Order No.	Pcs. / Pkt.
VIP-2/PT/2FLK14 (1-20) /S7	2903802	1

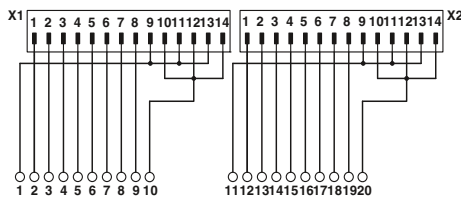

Connection scheme: VIP-2/.../2FLK14 (1-20) /S7

VIP termination boards for Allen-Bradley

These VIP - VARIOFACE Professional modules are used in combination with two 14-pos. system cables and the relevant front adapters for Allen-Bradley.

Features:

- Numerical labeling (1-20)
- Specifically for ControlLogix.

Notes:
For marking systems (e.g., "ZB 22:UNBEDRUCKT"; Order No. 0811862) and mounting material, see Catalog 5.

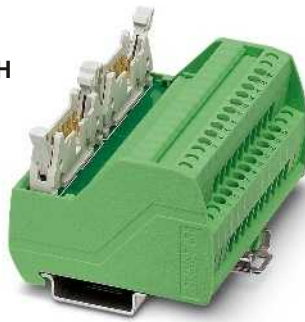

Passive interface modules for Allen-Bradley ControlLogix with screw connection

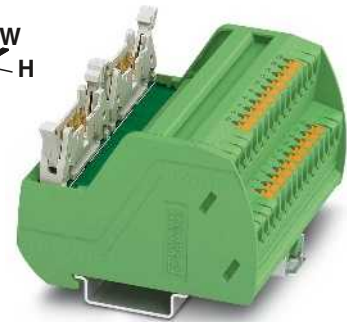

Passive interface modules for Allen-Bradley ControlLogix with push-in connection



Max. perm. operating voltage	60 V AC/DC
Max. perm. current (per branch)	1 A
Rated surge voltage	0.6 kV
Ambient temperature (operation)	-20°C ... 50°C
Mounting position	Any
Standards/regulations	IEC 60664, DIN EN 50178, IEC 62103
Connection method	Screw connection
	Field level
	Control system level
Connection data solid / stranded / AWG	IDC/FLK pin strip (2.54 mm) 0.2 ... 4 mm ² / 0.2 ... 2.5 mm ² / 24 - 12
Dimensions	65.5 mm / 56 mm

Technical data	
Max. perm. operating voltage	60 V AC/DC
Max. perm. current (per branch)	1 A
Rated surge voltage	0.6 kV
Ambient temperature (operation)	-20°C ... 50°C
Mounting position	Any
Standards/regulations	IEC 60664, DIN EN 50178, IEC 62103
Connection method	Push-in connection
	Field level
	Control system level
Connection data solid / stranded / AWG	IDC/FLK pin strip (2.54 mm) 0.2 ... 4 mm ² / 0.2 ... 2.5 mm ² / 24 - 12
Dimensions	72.1 mm / 56 mm

Technical data	
Max. perm. operating voltage	60 V AC/DC
Max. perm. current (per branch)	1 A
Rated surge voltage	0.6 kV
Ambient temperature (operation)	-20°C ... 50°C
Mounting position	Any
Standards/regulations	IEC 60664, DIN EN 50178, IEC 62103
Connection method	Push-in connection
	Field level
	Control system level
Connection data solid / stranded / AWG	IDC/FLK pin strip (2.54 mm) 0.2 ... 4 mm ² / 0.2 ... 2.5 mm ² / 24 - 12
Dimensions	72.1 mm / 56 mm

Description	No. of pos.	Module width W
VARIOFACE interface module, with ControlLogix-specific marking from 1 to 20		
- with screw connection	14	80.6 mm
- with push-in connection	14	82.5 mm

Ordering data		
Type	Order No.	Pcs. / Pkt.
VIP-2/SC/2FLK14/AB-1756	2322333	1

Ordering data		
Type	Order No.	Pcs. / Pkt.
VIP-2/PT/2FLK14/AB-1756	2904288	1

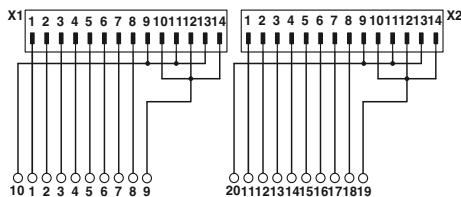

Connection scheme VIP-2.../2FLK14/AB-1756

System cabling for controllers

VARIOFACE system cabling

VIP termination boards with 2-conductor connection technology for 8 channels

These VIP VARIOFACE modules are used in combination with 14-pos. system cables and the relevant front adapters.

Features:

- Byte-wise labeling
- For digital I/O modules
- Negative or positive connection per signal.

Notes:
For marking systems (e.g., "ZB 22:UNBEDRUCKT"; Order No. 0811862) and mounting material, see Catalog 5.



Passive interface modules with screw connection



Passive interface modules with push-in connection

N



Max. perm. operating voltage	60 V DC
Max. perm. current (per branch)	1 A
Max total current (voltage supply)	3 A (per byte)
Rated surge voltage	0.6 kV
Ambient temperature (operation)	-20°C ... 50°C
Mounting position	Any
Standards/regulations	IEC 60664, DIN EN 50178, IEC 62103
Connection method	Screw connection
	Field level
	Control system level
Connection data solid / stranded / AWG	IDC/FLK pin strip (2.54 mm)
Dimensions	0.2 ... 4 mm ² / 0.2 ... 2.5 mm ² / 24 - 12
	65.5 mm / 56 mm

Technical data

Technical data

Max. perm. operating voltage	60 V DC
Max. perm. current (per branch)	1 A
Max total current (voltage supply)	3 A (per byte)
Rated surge voltage	0.6 kV
Ambient temperature (operation)	-20°C ... 50°C
Mounting position	Any
Standards/regulations	IEC 60664, DIN EN 50178, IEC 62103
Connection method	Push-in connection
	Field level
	Control system level
Connection data solid / stranded / AWG	IDC/FLK pin strip (2.54 mm)
Dimensions	0.14 ... 2.5 mm ² / 0.14 ... 2.5 mm ² / 26 - 14
	72.1 mm / 56 mm

Max. perm. operating voltage	60 V DC
Max. perm. current (per branch)	1 A
Max total current (voltage supply)	3 A (per byte)
Rated surge voltage	0.6 kV
Ambient temperature (operation)	-20°C ... 50°C
Mounting position	Any
Standards/regulations	IEC 60664, DIN EN 50178, IEC 62103
Connection method	Push-in connection
	Field level
	Control system level
Connection data solid / stranded / AWG	IDC/FLK pin strip (2.54 mm)
Dimensions	0.14 ... 2.5 mm ² / 0.14 ... 2.5 mm ² / 26 - 14
	72.1 mm / 56 mm

Ordering data

Ordering data

Description	No. of pos.	Module width W
VARIOFACE interface module , for eight channels, each with an additional terminal block per signal for a common minus potential		
- with screw connection	14	50 mm
- with push-in connection	14	52 mm
VARIOFACE interface module , for eight channels, each with an additional terminal block per signal for a common plus potential		
- with screw connection	14	50 mm
- with push-in connection	14	52 mm

Type	Order No.	Pcs. / Pkt.
VIP-2/SC/FLK14/8M/PLC	2322281	1
VIP-2/SC/FLK14/8P/PLC	2322294	1

Type	Order No.	Pcs. / Pkt.
VIP-2/PT/FLK14/8M/PLC	2904283	1
VIP-2/PT/FLK14/8P/PLC	2904284	1

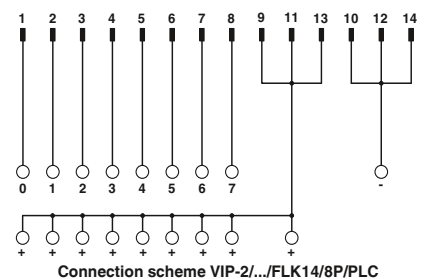
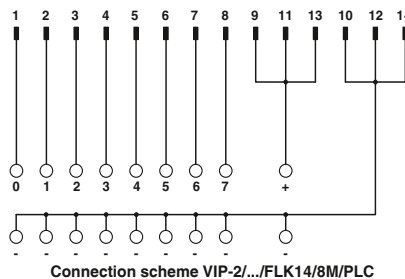

Termination boards with 2-conductor connection technology for 32 channels

These VARIOFACE modules are used in combination with 50-pos. system cables and the relevant front adapters.

The following module types with 2-conductor connection technology are available:

FLKM 50/32M/PLC

- Byte-wise labeling
- For digital I/O modules
- Negative connection for each signal.

FLKM 50/32P/PLC

- Byte-wise labeling
- For digital I/O modules
- Positive connection per signal.

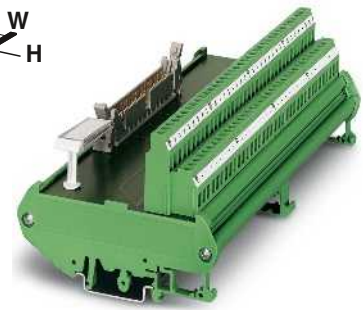

Passive interface modules with screw connection



Technical data

Max. perm. operating voltage	60 V DC
Max. perm. current (per branch)	1 A
Max total current (voltage supply)	8 A (per byte)
Rated surge voltage	0.8 kV
Ambient temperature (operation)	-20°C ... 50°C
Mounting position	Any
Standards/regulations	IEC 60664, DIN EN 50178, IEC 62103
Connection method	Screw connection
	Field level
	Control system level
Connection data solid / stranded / AWG	0.2 ... 4 mm ² / 0.2 ... 2.5 mm ² / 24 - 12
Dimensions	90 mm / 68 mm

Ordering data

Description	No. of pos.	Module width W	Type	Order No.	Pcs. / Pkt.
VARIOFACE interface module, for 32 channels, each with an additional terminal block per signal for a common minus potential	50	192 mm	FLKM 50/32M/PLC	2289719	1
VARIOFACE interface module, for 32 channels, each with an additional terminal block per signal for a common plus potential	50	192 mm	FLKM 50/32P/PLC	2291121	1

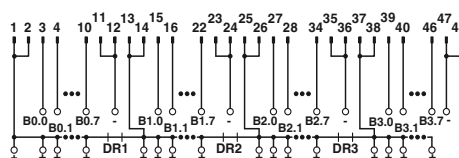

Connection scheme: FLKM 50/32P/PLC

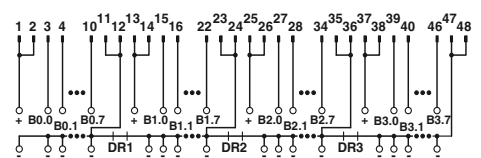

Connection scheme: FLKM 50/32M/PLC

System cabling for controllers

VARIOFACE system cabling

Termination boards with fuses with 2-conductor connection method

These VARIOFACE modules are used in combination with 14- or 50-pos. system cables and the relevant front adapters.

The following module types with fuses and 2-conductor connection technology are available:

FLKM 14/8M/SI/PLC (for 8 channels) FLKM 50/32M/SI/PLC (for 32 channels)

- Byte-wise labeling
- Can be used for digital I/O modules
- Plug-in fuse (IEC 127-3, 1AF) per signal path (F1)
- Plug-in fuse (IEC 127-3, 2AF) per voltage supply (F2)
- Negative connection for each signal.

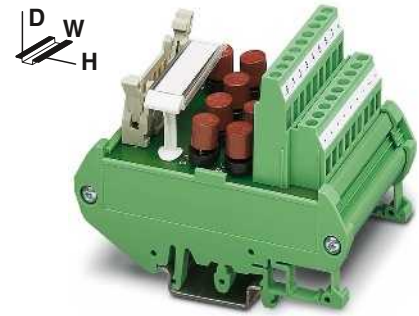

Passive fuse modules for 8 or 32 channels



Technical data

FLKM 14/8M/SI/PLC	FLKM 50/32M/PLC
60 V DC	60 V DC
1 A	1 A
2 A	2 A (per byte)
0.8 kV	0.8 kV
-20°C ... 50°C	-20°C ... 50°C
Any	Any
IEC 60664, DIN EN 50178, IEC 62103	IEC 60664, DIN EN 50178, IEC 62103
Screw connection	Screw connection
Field level	Control system level
IDC/FLK pin strip (2.54 mm)	IDC/FLK pin strip (2.54 mm)

Max. perm. operating voltage
Max. perm. current (per branch)
Max total current (voltage supply)
Rated surge voltage
Ambient temperature (operation)
Mounting position
Standards/regulations
Connection method

Connection data solid / stranded / AWG
Dimensions

0.2 ... 4 mm² / 0.2 ... 2.5 mm² / 24 - 12
90 mm / 68 mm

Ordering data

Description	No. of pos.	Module width W
VARIOFACE module, for eight channels, each with an additional terminal block and fuse per signal, (common minus potential)	14	57 mm
VARIOFACE module, for 32 channels, each with an additional terminal block and fuse per signal, (common minus potential)	50	192 mm

Type	Order No.	Pcs. / Pkt.
FLKM 14/8M/SI/PLC	2294487	1
FLKM 50/32M/SI/PLC	2294490	1

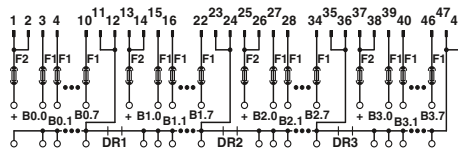

Connection scheme: FLKM 50/32M/SI/PLC

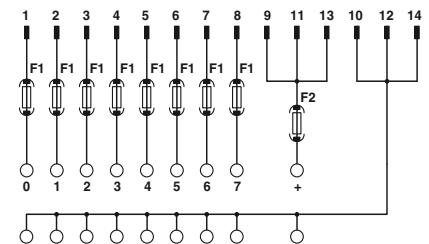

Connection scheme: FLKM 14/8M/SI/PLC

VIP initiator modules for 8 channels

These VIP - VARIOFACE Professional modules are used in combination with 14-pos. system cables and the relevant front adapters.

Features:

- Byte-wise labeling
- For digital I/O modules
- Positive and negative connection per signal
- Optionally with LED.

Notes:
For marking systems (e.g., "ZB 22:UNBEDRUCKT"; Order No. 0811862) and mounting material, see Catalog 5.

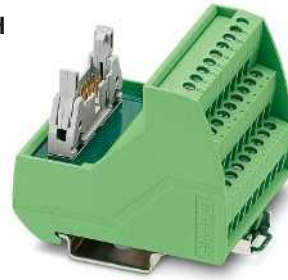

Initiator modules with screw connection

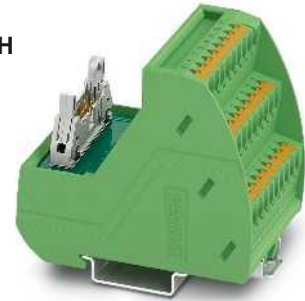

Initiator modules with push-in connection



Max. perm. operating voltage	
Max. perm. current (per branch)	
Max total current (voltage supply)	
Rated surge voltage	
Ambient temperature (operation)	
Mounting position	
Standards/regulations	
Connection method	Field level
	Control system level
Connection data solid / stranded / AWG	H / D
Dimensions	

Technical data	
VIP-3/SC/FLK14/8IM/PLC	VIP-3/SC/FLK14/8IM/LED/PLC
60 V DC	24 V DC
1 A	1 A
3 A	3 A
0.6 kV	0.6 kV
-20°C ... 50°C	-20°C ... 50°C
Any	Any
IEC 60664, DIN EN 50178, IEC 62103	
Screw connection	Screw connection
IDC/FLK pin strip (2.54 mm)	IDC/FLK pin strip (2.54 mm)
0.2 ... 4 mm ² / 0.2 ... 2.5 mm ² / 24 - 12	
69 mm / 62 mm	

Technical data	
VIP-3/PT/FLK14/8IM/PLC	VIP-3/PT/FLK14/8IM/LED/PLC
60 V DC	24 V DC
1 A	1 A
3 A	3 A
0.6 kV	0.6 kV
-20°C ... 50°C	-20°C ... 50°C
Any	Any
IEC 60664, DIN EN 50178, IEC 62103	
Push-in connection	Push-in connection
IDC/FLK pin strip (2.54 mm)	IDC/FLK pin strip (2.54 mm)
0.14 ... 2.5 mm ² / 0.14 ... 2.5 mm ² / 26 - 14	
75.8 mm / 63 mm	

Description	No. of pos.	Module width W
VARIOFACE initiator module , for connecting 8 PNP initiators, with an additional positive and negative terminal block each per signal		
- with screw connection	14	52.3 mm
- with push-in connection	14	52 mm
VARIOFACE initiator module with LED , for connecting 8 PNP initiators, with an additional positive and negative terminal block each per signal		
- with screw connection	14	52.3 mm
- with push-in connection	14	52 mm

Ordering data		
Type	Order No.	Pcs. / Pkt.
VIP-3/SC/FLK14/8IM/PLC	2322278	1
VIP-3/SC/FLK14/8IM/LED/PLC	2322265	1

Ordering data		
Type	Order No.	Pcs. / Pkt.
VIP-3/PT/FLK14/8IM/PLC	2904282	1
VIP-3/PT/FLK14/8IM/LED/PLC	2904281	1

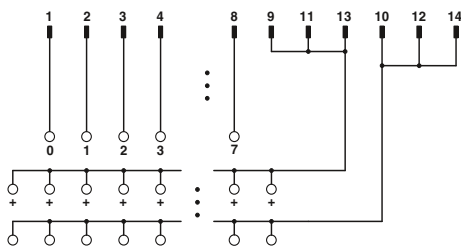

Connection scheme VIP-3/.../FLK14/8IM/PLC

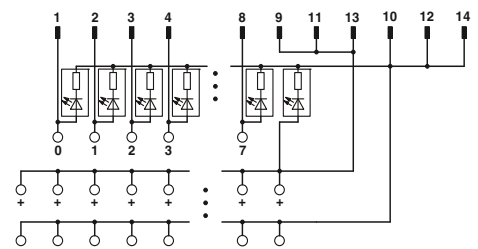

Connection scheme VIP-3/.../FLK14/8IM/LED/PLC

System cabling for controllers

VARIOFACE system cabling

Initiator modules for 32 channels

These VARIOFACE modules are used in combination with 50-pos. system cables and the relevant front adapters for digital I/O modules.

Features:

- Byte-wise labeling
- Positive and negative connection per signal
- Optionally with LED

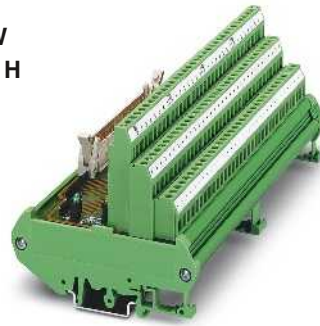

Initiator modules for 32 channels, with screw connection

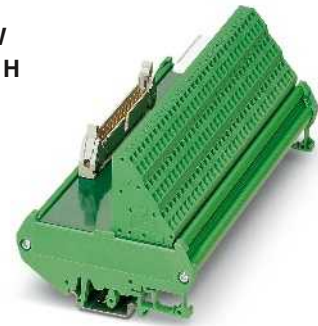

Initiator modules for 32 channels, with spring-cage connection



		Technical data		Technical data	
Max. perm. operating voltage		... 50/32 IM	... 50/32 IM/LA	60 V DC	60 V DC
Max. perm. current (per branch)		60 V DC	20 V DC (up to 30 V DC)	1 A	1 A
Max total current (voltage supply)		1 A	1 A	2 A (per byte)	2 A (per byte)
Status indication		2 A (per byte)	2 A (per byte)	-	-
Rated surge voltage		No	LED	0.6 kV	0.6 kV
Ambient temperature (operation)		0.8 kV	0.8 kV	-20°C ... 50°C	-20°C ... 50°C
Mounting position		-20°C ... 50°C	-20°C ... 50°C	Any	Any
Standards/regulations		Any	Any	DIN EN 50178,	DIN EN 50178,
Connection method	Field level	IEC 60664, DIN EN 50178, IEC 62103	IEC 60664, DIN EN 50178, IEC 62103	Spring-cage connection	Spring-cage connection
	Control system level	Screw connection	Screw connection	IDC/FLK pin strip (2.54 mm)	IDC/FLK pin strip (2.54 mm)
Connection data solid / stranded / AWG		IDC/FLK pin strip (2.54 mm)	IDC/FLK pin strip (2.54 mm)	0.2 ... 2.5 mm ² / 0.2 ... 1.5 mm ² / 24 - 12	0.2 ... 2.5 mm ² / 0.2 ... 1.5 mm ² / 24 - 12
Dimensions	H / D	0.2 ... 4 mm ² / 0.2 ... 2.5 mm ² / 24 - 12	0.2 ... 4 mm ² / 0.2 ... 2.5 mm ² / 24 - 12	90 mm / 81 mm	90 mm / 73.5 mm

			Ordering data			Ordering data		
Description	No. of pos.	Module width W	Type	Order No.	Pcs. / Pkt.	Type	Order No.	Pcs. / Pkt.
VARIOFACE initiator module, for connection of 32 PNP initiators	50	180 mm	FLKMS 50/32IM/PLC	2284523	1			
VARIOFACE initiator module, same as before, however with light indicator	50	180 mm	FLKMS 50/32IM/LA/PLC	2284510	1			
VARIOFACE initiator module, for connection of 32 PNP initiators	50	180 mm	FLKMS 50/32IM/ZFKDS/PLC	2901389	1			

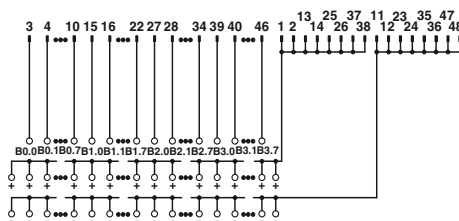

Connection scheme: FLKMS 50/32IM/PLC, ...50/32IM/ZFKDS/PLC

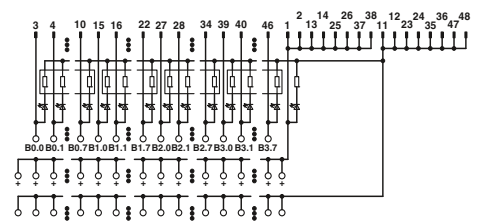

FLKMS 50/32IM/LA/PLC connection scheme

COMPACT-LINE initiator modules with spring-cage connection

These VARIOFACE modules are used in combination with 14- and 50-pos. system cables and the relevant front adapters.

The following COMPACT-LINE initiator modules are available:

UM 45-FLK14/8IM/.../PLC (for 8 channels)

UM 45-FLK 50/32IM/.../PLC (for 32 channels)

- Byte-wise labeling
- Can be used for digital I/O modules
- Positive and negative connection for every signal

Notes:
Due to the geometry, it is not possible to couple any molded FLK connectors (e.g., VIP-PA...S7).



Sensor modules for 8 or 32 channels With spring-cage connection



Max. perm. operating voltage	60 V DC
Max. perm. current (per branch)	1 A
Max total current (voltage supply)	3 A
Rated surge voltage	0.8 kV
Ambient temperature (operation)	-20°C ... 50°C
Mounting position	Any
Standards/regulations	IEC 60664, DIN EN 50178, IEC 62103
Connection method	Field level Control system level
Connection data solid / stranded / AWG	0.2 ... 2.5 mm ² / 0.2 ... 1.5 mm ² / 24 - 14
Dimensions	H / D 45 mm / 61 mm

Technical data		
UM 45-FLK 14/.../PLC	UM 45-FLK 50/.../PLC	
60 V DC	60 V DC	
1 A	1 A	
3 A	2 A (per byte)	
0.8 kV	0.8 kV	
-20°C ... 50°C	-20°C ... 50°C	
Any	Any	
IEC 60664, DIN EN 50178, IEC 62103		
Spring-cage connection	Spring-cage connection	
IDC/FLK pin strip (2.54 mm)	IDC/FLK pin strip (2.54 mm)	

Description	No. of pos.	Module width W
VARIOFACE-COMPACT-LINE initiator module, for connection of eight PNP initiators	14	75 mm
VARIOFACE-COMPACT-LINE initiator module, for connection of 32 PNP initiators	50	197 mm

Ordering data		
Type	Order No.	Pcs. / Pkt.
UM 45-FLK14/ 8IM/ZFKDS/PLC	2965211	1
UM 45-FLK50/32IM/ZFKDS/PLC	2965224	1

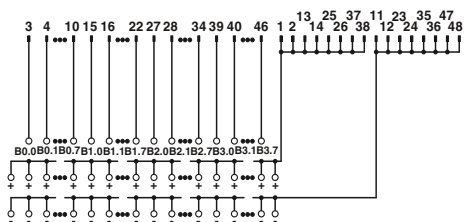

UM 45-FLK50/32IM/ZFKDS/PLC connection scheme

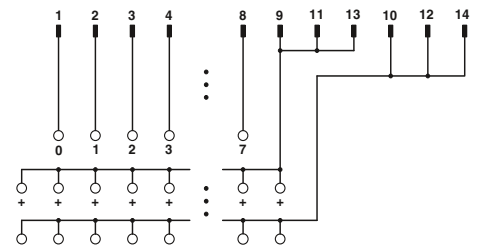

UM 45-FLK14/8IM/ZFKDS/PLC connection scheme

System cabling for controllers

VARIOFACE system cabling

Controller boards with knife disconnect terminal blocks

These VARIOFACE modules with knife disconnection and test connection for each signal (2 or 2.3 mm Ø test plug) are used in combination with the respective front adapters.

FLKM14/KDS3-MT/PPA/PLC

(for 8 channels)

FLKM 50/KDS3-MT/PPA/PLC

(for 32 channels)

- Byte-wise labeling
- Can be used for digital I/O modules

FLKM-2FLK14/KDS3-MT/PPA/S7

- Numerical labeling (1-20)
- Specially for S7-300 (in conjunction with the front adapter FLKM 14-PA-S300, Order No.: 2299770)

FLKM 50/KDS3-MT/PPA/7-300

- Numerical labeling (1-40)
- Specially for S7-300 (in conjunction with the front adapter FLKM 50-PA-S300, Order No.: 2294445).

FLKM 50/KDS3-MT/PPA/AN/PLC

- Numerical labeling (1-50)
- Specially for S7-400 (in conjunction with the front adapter FLKM 50-PA-S400 (3-48) Order No.: 2294908).

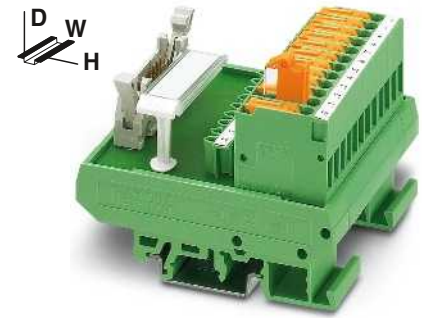

Passive interface modules for 8 or 32 channels with knife disconnect terminal blocks



Technical data

FLKM...14/KDS 3-MT...	FLKM 50/KDS 3-MT...
60 V DC	60 V DC
1 A	1 A
3 A	2 A (per byte)
0.8 kV	0.8 kV
-20°C ... 50°C	-20°C ... 50°C
Any	Any
IEC 60664, DIN EN 50178, IEC 62103	
Screw connection with disconnect knife	Screw connection with disconnect knife
Field level	Field level
IDC/FLK pin strip (2.54 mm)	IDC/FLK pin strip (2.54 mm)
Control system level	
0.2 ... 4 mm² / 0.2 ... 2.5 mm² / 24 - 12	
77 mm / 61 mm	

Ordering data

Type	Order No.	Pcs. / Pkt.
FLKM 14/KDS3-MT/PPA/PLC	2290423	1
FLKM 50/KDS3-MT/PPA/PLC	2290614	1
FLKM-2FLK14/KDS3-MT/PPA/S7	2295062	1
FLKM 50/KDS3-MT/PPA/S7-300	2304490	1
FLKM 50/KDS3-MT/PPA/AN/PLC	2291587	1

Max. perm. operating voltage	60 V DC
Max. perm. current (per branch)	1 A
Max total current (voltage supply)	3 A
Rated surge voltage	0.8 kV
Ambient temperature (operation)	-20°C ... 50°C
Mounting position	Any
Standards/regulations	IEC 60664, DIN EN 50178, IEC 62103
Connection method	Screw connection with disconnect knife
	Field level
	Control system level
Connection data solid / stranded / AWG	0.2 ... 4 mm² / 0.2 ... 2.5 mm² / 24 - 12
Dimensions	H / D
	77 mm / 61 mm

Description	No. of pos.	Module width W
VARIOFACE interface module , for eight channels, with knife disconnect terminal blocks and test sockets to the field and the system	14	67 mm
VARIOFACE interface module , for 32 channels, with knife disconnect terminal blocks and test sockets to the field and the system	50	214 mm
VARIOFACE interface module , for SIMATIC S7-300 with SIMATIC-specific labeling (1-20), knife disconnect terminal blocks, and test sockets to the field and the system	14	113 mm
VARIOFACE interface module , same as before, however, with SIMATIC-specific labeling (1-40)	50	214 mm
VARIOFACE interface module , same as before, however, for SIMATIC S7-400 with SIMATIC-specific labeling (3-48)	50	259 mm

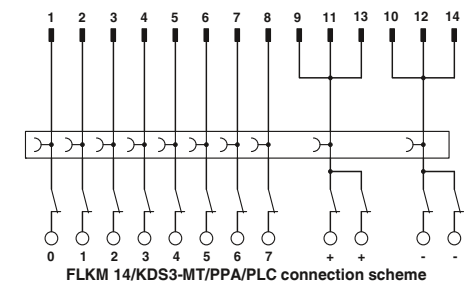
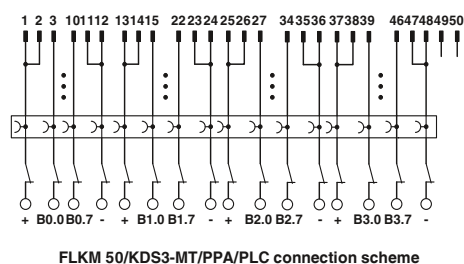
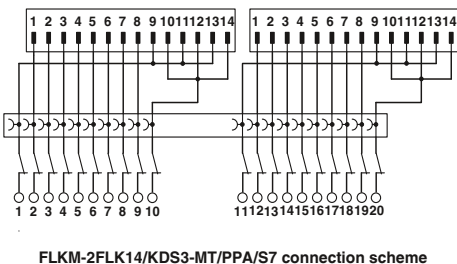
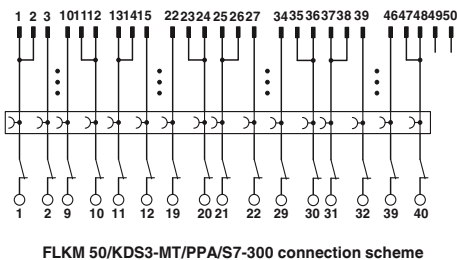
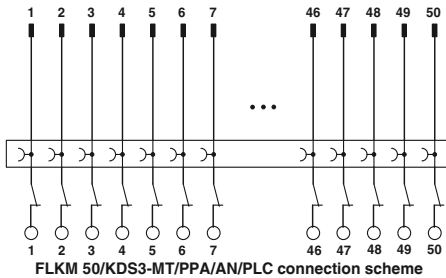

Simulation module with switches

These VARIOFACE modules enable simple simulation of the control and peripheral hardware for 8 signals.

The UM 45-DI/DO/S/LA/SIM8 switch module is assembled for signal transmission with COMBICON screw connector for single-conductor wiring. Alternatively, connection to the PLC system cabling is established through a 14-pos. flat-ribbon cable pin strip. Connection to the front adapters of the PLC system cabling is established through 14-pos. system cables with socket strips.

Each signal path is allocated an LED which signals the “high active” signal state. The supply voltage to the modules is signaled via a green LED.

Notes:
Type of housing: Terminal blocks: Polyamide PA non-reinforced, color: green. Housing: PVC
Marking systems and mounting material See Catalog 5

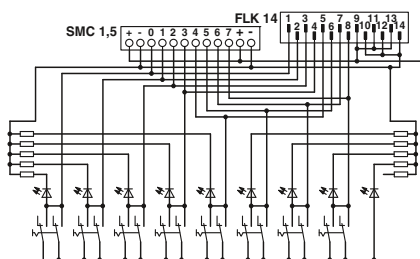

Max. perm. operating voltage	24 V DC
Max. perm. current (per branch)	1 A
Max total current (voltage supply)	8 A (+, - terminal block)
Rated surge voltage	0.8 kV
Ambient temperature (operation)	-20°C ... 50°C
Mounting position	Any
Standards/regulations	IEC 60664, DIN EN 50178, IEC 62103
Connection data solid / stranded / AWG	0.14 ... 1.5 mm ² / 0.14 ... 1.5 mm ² / 28 - 16
Dimensions	45 mm / 51 mm

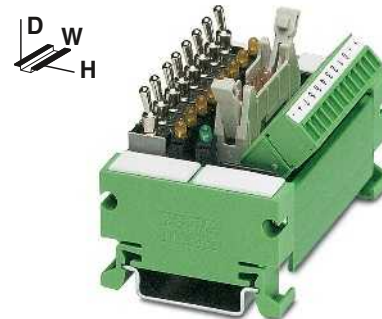

Switch module

Technical data

Description	No. of pos.	Module width W
VARIOFACE switch module, for simulation		75 mm

Ordering data		
Type	Order No.	Pcs. / Pkt.
UM 45-DI/DO/S/LA/SIM8	2968205	1

Simulation module for display

These VARIOFACE modules enable simple simulation of the control and peripheral hardware for 8 signals.

The UM 45-DO/LA/SIM8 display module is assembled for signal transmission with COMBICON screw connector for single-conductor wiring. Alternatively, connection to the PLC system cabling is established through a 14-pos. flat-ribbon cable pin strip. Connection to the front adapters of the PLC system cabling is established through 14-pos. system cables with socket strips.

Each signal path is allocated an LED which signals the “high active” signal state. The supply voltage to the modules is signaled via a green LED.

Notes:
Type of housing: Terminal blocks: Polyamide PA non-reinforced, color: green. Housing: PVC
Marking systems and mounting material See Catalog 5

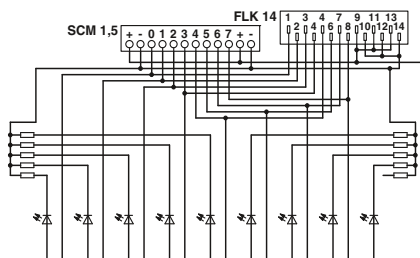

Max. perm. operating voltage	24 V DC
Max. perm. current (per branch)	1 A
Max total current (voltage supply)	8 A (+, - terminal block)
Rated surge voltage	0.8 kV
Ambient temperature (operation)	-20°C ... 50°C
Mounting position	Any
Standards/regulations	IEC 60664, DIN EN 50178, IEC 62103
Connection data solid / stranded / AWG	0.14 ... 1.5 mm ² / 0.14 ... 1.5 mm ² / 28 - 16
Dimensions	45 mm / 51 mm

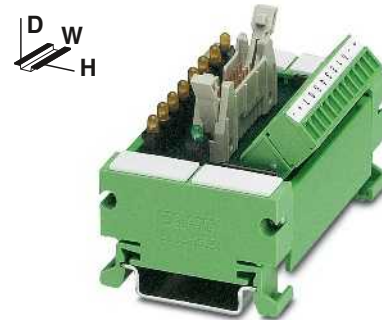

Indicator module

Technical data

Description	No. of pos.	Module width W
VARIOFACE display module, for simulation		75 mm

Ordering data		
Type	Order No.	Pcs. / Pkt.
UM 45-DO/LA/SIM8	2968195	1

VARIOFACE system cabling

Adapter for PLC-INTERFACE (6.2 mm)

PLC-V8/... are the VARIOFACE adapters connecting the eight slim 6.2 mm PLC-INTERFACE modules to the VARIOFACE system cabling:

- Can be plugged into the bridge shafts of eight aligned PLC-INTERFACE modules
- Freely definable configuration with relays, optocouplers, and passive feed-through terminal blocks
- With D-SUB connection as an option for universal connections

Notes:

For cross-reference list with matching PLC-INTERFACE modules, see page 488

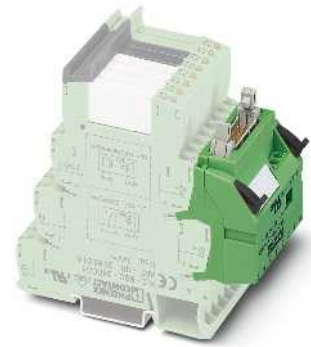

VARIOFACE adapter for 6.2 mm PLC-INTERFACE



Technical data

Max. perm. operating voltage	24 V DC ±25%
Max. perm. current (per branch)	1 A (per signal path)
Max total current (voltage supply)	3 A
Rated surge voltage	0.8 kV
Ambient temperature (operation)	-40°C ... 70°C
Standards/regulations	IEC 60664, DIN EN 50178, IEC 62103
Connection method	Screw connection
	Power supply
	Signal level
Connection data solid / stranded / AWG	IDC/FLK pin strip (2.54 mm) 0.2 ... 4 mm ² / 0.2 ... 2.5 mm ² / 24 - 12
Dimensions	100 mm / 94 mm

Ordering data

Description	No. of pos.	Module width W	Type	Order No.	Pcs. / Pkt.
V8 adapter, for 8 PLC interfaces (6.2 mm), with FLK connection, for PLC system cabling, positive switching					
OUTPUT	14	49.6 mm	PLC-V8/FLK14/OUT	2295554	1
INPUT	14	49.6 mm	PLC-V8/FLK14/IN	2296553	1
V8 adapter, for 8 PLC interfaces (6.2 mm), with FLK connection, for PLC system cabling, negative switching					
OUTPUT	14	49.6 mm	PLC-V8/FLK14/OUT/M	2304102	1
INPUT	14	49.6 mm	PLC-V8/FLK14/IN/M	2304115	1
V8 output adapter, for 8 PLC interfaces (6.2 mm), with 15-pos. D-SUB connection					
Pin strip	15	49.6 mm	PLC-V8/D15S/OUT	2296058	1
Socket strip	15	49.6 mm	PLC-V8/D15B/OUT	2296061	1
V8 input adapter, for 8 PLC interfaces (6.2 mm), with 15-pos. D-SUB connection					
Pin strip	15	49.6 mm	PLC-V8/D15S/IN	2296074	1
Socket strip	15	49.6 mm	PLC-V8/D15B/IN	2296087	1

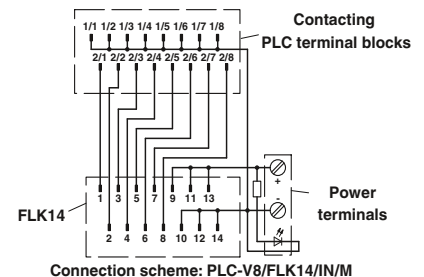
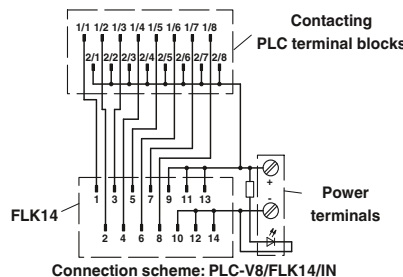
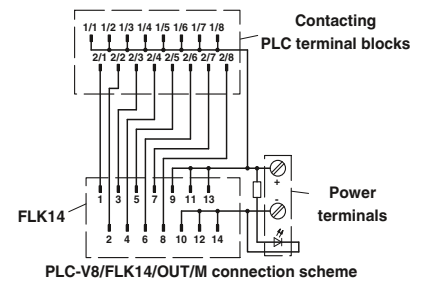
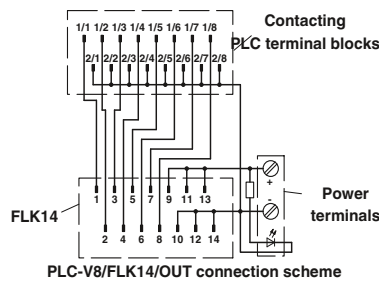

Adapter for PLC-INTERFACE (14 mm)

PLC-V8L/... are the VARIOFACE adapters connecting the eight 14 mm PLC-INTERFACE modules (2 PDT, HC, and IC types) to the system cabling:

- Can be plugged into the bridge shafts of eight aligned PLC-INTERFACE modules
- Freely selectable assembly with relays or optocouplers

Notes:
For cross-reference list with matching PLC-INTERFACE modules, see page 488

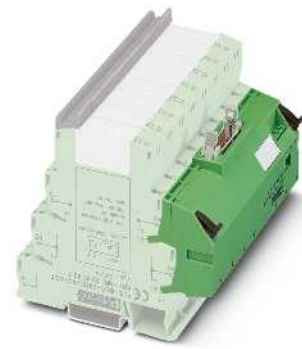

VARIOFACE adapter for 14 mm PLC-INTERFACE



Technical data

Max. perm. operating voltage	24 V DC ±25%
Max. perm. current (per branch)	1 A (per signal path)
Max total current (voltage supply)	3 A
Rated surge voltage	0.8 kV
Ambient temperature (operation)	-40°C ... 70°C
Mounting position	Any
Standards/regulations	IEC 60664, DIN EN 50178, IEC 62103
Connection method	Screw connection
	Power supply
	Signal level
Connection data solid / stranded / AWG	0.2 ... 4 mm ² / 0.2 ... 2.5 mm ² / 24 - 12
Dimensions	100 mm / 94 mm

Ordering data

Description	No. of pos.	Module width W	Type	Order No.	Pcs. / Pkt.
V8 adapter, for 8 PLC interfaces (14 mm), with FLK connection, for PLC system cabling, positive switching	14	112.3 mm	PLC-V8L/FLK14/OUT	2299660	1
V8 adapter, for 8 PLC interfaces (14 mm), with FLK connection, for PLC system cabling, negative switching	14	112.3 mm	PLC-V8L/FLK14/OUT/M	2304306	1

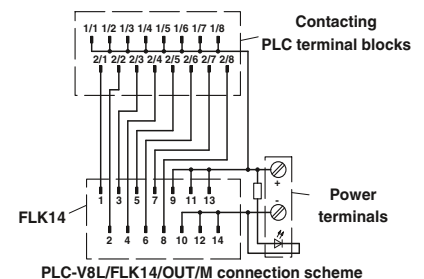
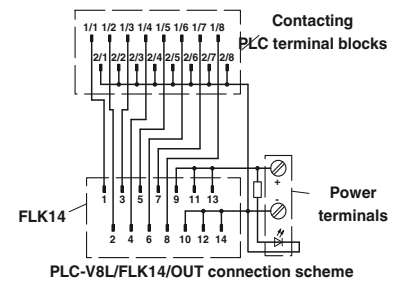

VARIOFACE system cabling

Feed-through terminal blocks for PLC-INTERFACE

The VARIOFACE PLC-VT terminals are passive feed-through terminal blocks, with the same shape as the 6.2 mm slim relay and PLC-INTERFACE optocoupler interfaces. This makes it possible to implement 8-channel interface blocks for the system cabling, which can be adapted to a bit for the particular application. For individual requirements, the relay, optocoupler or the PLC-VT terminal blocks for passive signal transmission can be combined as needed.

PLC-VT PLC-VT/LA

- Can be combined with PLC-INTERFACE universal series
- Signal path with additional potential level for free assignment (two-conductor connection)
- Optionally with LED

Max. perm. operating voltage	
Max. perm. current (per branch)	
Ambient temperature (operation)	
Mounting position	
Standards/regulations	
Connection data solid / stranded / AWG	
Dimensions	H / D

Description	No. of pos.	Module width W
VARIOFACE feed-through terminal block (two-conductor connection), for PLC-INTERFACE universal series		6.2 mm
VARIOFACE feed-through terminal block , same as before, however, with 24 V DC light indicator		6.2 mm

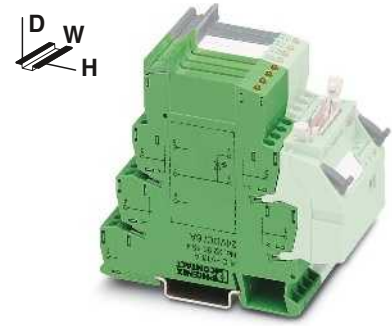

VARIOFACE feed-through terminal blocks for PLC-INTERFACE universal series



Technical data

PLC-VT	PLC-VT/LA
max. 250 V AC/DC	24 V DC
6 A (per signal conductor)	6 A (per signal conductor)
-40°C ... 70°C	-40°C ... 70°C
Any	Any
DIN EN 50178, IEC 62103	
0.2 ... 4 mm ² / 0.2 ... 2.5 mm ² / 24 - 12	
80 mm / 94 mm	

Ordering data

Type	Order No.	Pcs. / Pkt.
PLC-VT	2296870	10
PLC-VT/LA	2296854	10



PLC-VT connection scheme

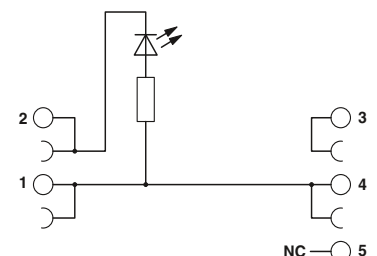

PLC-VT/LA connection scheme

Feed-through terminal blocks for PLC-INTERFACE

The VARIOFACE PLC-VT terminals are passive feed-through terminal blocks, with the same shape as the 6.2 mm slim relay and PLC-INTERFACE optocoupler interfaces. This makes it possible to implement 8-channel interface blocks for the system cabling, which can be adapted to a bit for the particular application. For individual requirements, the relay, optocoupler or the PLC-VT terminal blocks for passive signal transmission can be combined as needed.

PLC-VT/ACT PLC-VT/ACT/LA

- Can be combined with PLC-INTERFACE actuator series
- Signal path with two additional potential levels for free assignment (three-conductor connection)
- Optionally with LED

The system connection is made via the PLC-V8 adapter.

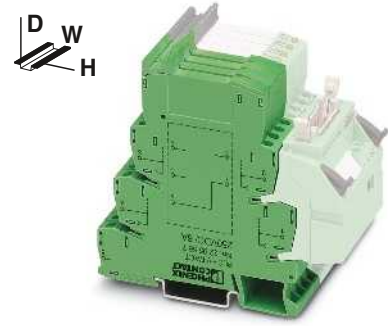

VARIOFACE feed-through terminal blocks for PLC-INTERFACE actuator series



Max. perm. operating voltage	Max. perm. current (per branch)
Ambient temperature (operation)	Mounting position
Standards/regulations	Connection data solid / stranded / AWG
Dimensions	H / D

Technical data	
PLC-VT/AKT max. 250 V AC/DC 6 A (per signal conductor)	PLC-VT/AKT/LA 24 V DC 6 A (per signal conductor)
-40°C ... 70°C Any DIN EN 50178, IEC 62103 0.2 ... 4 mm ² / 0.2 ... 2.5 mm ² / 24 - 12 80 mm / 94 mm	-40°C ... 70°C Any

Description	No. of pos.	Module width W
VARIOFACE feed-through terminal block (three-conductor connection), for PLC-INTERFACE actuator series		6.2 mm
VARIOFACE feed-through terminal block, same as before, however, with 24 V DC light indicator		6.2 mm

Ordering data		
Type	Order No.	Pcs. / Pkt.
PLC-VT/ACT	2295567	10
PLC-VT/ACT/LA	2296867	10

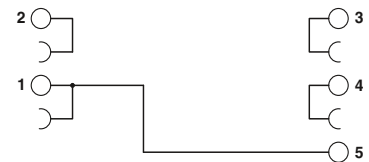

PLC-VT/ACT connection scheme

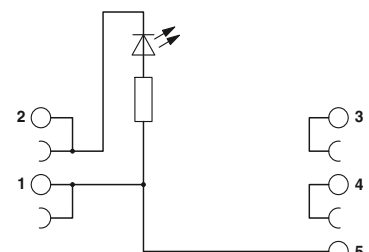

PLC-VT/ACT/LA connection scheme

Cross-reference list for PLC-V8 adapters with matching PLC-INTERFACE modules

Series



Function	Contact	Input	Output	Page	Spring-cage connection	Order No.:	
Relay	1 PDT	24 V DC	250 V AC/DC / 6 A	322	PLC-RSP-24DC/21	2966472	
		24 V DC	250 V AC/DC / 10 A	333	PLC-RSP-24DC/21HC	2912277	
		12 V DC	30 V AC/36 V DC / 50 mA	323	PLC-RSP-12DC/21AU	2967442	
		24 V DC	30 V AC/36 V DC / 50 mA	323	PLC-RSP-24DC/21AU	2966540	
		24 V AC/DC	30 V AC/36 V DC / 50 mA	323	PLC-RSP-24UC/21AU	2966553	
		48 V DC	30 V AC/36 V DC / 50 mA	323	PLC-RSP-48DC/21AU	2966566	
		60 V DC	30 V AC/36 V DC / 50 mA	323	PLC-RSP-60DC/21AU	2966579	
		120 V AC/DC	30 V AC/36 V DC / 50 mA	323	PLC-RSP-120UC/21AU	2966582	
		230 V AC/DC	30 V AC/36 V DC / 50 mA	323	PLC-RSP-230UC/21AU	2966647	
		120 V AC	30 V AC/36 V DC / 50 mA ¹⁾	334	PLC-BSP-120UC/21/SO46	2980351 ³⁾	
	230 V AC	30 V AC/36 V DC / 50 mA ¹⁾	334	PLC-BSP-230UC/21/SO46	2980377 ³⁾		
	2 PDTs	24 V DC	250 V AC/DC / 6 A	323	PLC-RSP-24DC/21-21	2912507	
		24 V DC	30 V AC/DC / 50 mA	323	PLC-RSP-24DC/21-21AU	2912578	
	Relay switch	1 N/O contact	24 V AC/DC	250 V AC/DC / 6 A	350	PLC-RSP-24UC/1/S/H	2982249
24 V AC/DC			250 V AC/DC / 6 A	350	PLC-RSP-24UC/1/S/L	2834889	
Optocoupler	1 N/O contact, electronic	24 V DC	24 V DC / 3 A	325	PLC-OSP-24DC/24DC/2	2967471	
		24 V DC	24 V DC / 10 A	353	PLC-OSP-24DC/24DC/10/R	2982715	
		24 V DC	250 V AC / 0.75 A	325	PLC-OSP-24DC/230AC/1	2967895	
		24 V DC	300 V DC / 1 A	352	PLC-OSP-24DC/300DC/1	2980830	
		24 V DC	48 V DC / 100 mA	324	PLC-OSP-24DC/48DC/100	2967549	
		48 V DC	48 V DC / 100 mA	324	PLC-OSP-48DC/48DC/100	2967743	
		60 V DC	48 V DC / 100 mA	324	PLC-OSP-60DC/48DC/100	2967756	
		120 V AC/DC	48 V DC / 100 mA	324	PLC-OSP-120UC/48DC/100	2967552	
		230 V AC/DC	48 V DC / 100 mA	324	PLC-OSP-230UC/48DC/100	2967565	
		NAMUR	24 V DC / 50 mA	364	PLC-SP-EIK 1-SVN 24P/P	2982676	
	120 V AC	48 V DC / 100 mA ²⁾	334	PLC-BSP-120UC/21/SO46	2980351 ³⁾		
	230 V AC	48 V DC / 100 mA ²⁾	334	PLC-BSP-230UC/21/SO46	2980377 ³⁾		
	1 PDT, electronic	24 V DC	48 V DC / 0.5 A	353	PLC-OSP-24DC/48DC/500/W	2980649	
Feed-through	-	250 V AC/DC	250 V AC/DC	486	-	-	
		24 V DC	24 V DC	486	-	-	
Relay	1 N/O contact	24 V DC	250 V AC/DC / 6 A	326	PLC-RSP-24DC/1/ACT	2967345	
		24 V DC	250 V AC/DC / 10 A (80 A; 20 ms)	332	PLC-RSP-24DC/11C/ACT	2912413	
	2 N/O contacts	24 V DC	250 V AC/DC / 6 A	327	-	-	
	Optocoupler	1 N/O contact, electronic	24 V DC	24 V DC / 3 A	327	PLC-OSP-24DC/24DC/2/ACT	2967507
			24 V DC	24 V DC / 5 A	328	-	-
			24 V DC	250 V AC / 0.75 A	327	-	-
			24 V DC	250 V AC / 2 A	328	-	-
Feed-through	-	250 V AC/DC	250 V AC/DC	487	-	-	
		24 V DC	24 V DC	487	-	-	
Relay	1 N/O contact	24 V DC	30 V AC/36 V DC / 50 mA	330	PLC-RSP-24DC/1AU/SEN	2967374	
		120 V AC/DC	30 V AC/36 V DC / 50 mA	330	PLC-RSP-120UC/1AU/SEN	2967390	
		230 V AC/DC	30 V AC/36 V DC / 50 mA	330	PLC-RSP-230UC/1AU/SEN	2967413	
		120 V AC	30 V AC/36 V DC / 50 mA ¹⁾	335	PLC-BSP-120UC/1/SEN/SO46	2980364 ³⁾	
		230 V AC	30 V AC/36 V DC / 50 mA ¹⁾	335	PLC-BSP-230UC/1/SEN/SO46	2980380 ³⁾	
	Optocoupler	1 N/O contact, electronic	24 V DC	48 V DC / 100 mA	331	PLC-OSP-24DC/48DC/100/SEN	2967578
			120 V AC/DC	48 V DC / 100 mA	331	PLC-OSP-120UC/48DC/100/SEN	2967581
			230 V AC/DC	48 V DC / 100 mA	331	PLC-OSP-230UC/48DC/100/SEN	2967594
			120 V AC	48 V DC / 100 mA ²⁾	335	PLC-BSP-120UC/1/SEN/SO46	2980364 ³⁾
			230 V AC	48 V DC / 100 mA ²⁾	335	PLC-BSP-230UC/1/SEN/SO46	2980380 ³⁾

¹⁾ Plug-in miniature relay insert: REL-MR-60DC/21AU, 2961134

²⁾ Plug-in solid-state relay insert: OPT-60DC/48DC/100, 2966621

³⁾ PLC-...SO46 is supplied as a basic terminal block with filter, but without relay or solid-state relay.

⁴⁾ Cannot be combined with the universal series (within a byte)



Push-in connection



Screw connection

	Order No.:		Order No.:	PLC-V8...OUT(M)	PLC-V8...IN(M)	PLC-V8L...OUT
PLC-RPT-24DC/21	2900299	PLC-RSC-24DC/21	2966171	X		
PLC-RPT-24DC/21HC	2900291	PLC-RSC-24DC/21HC	2967620			X
PLC-RPT-12DC/21AU	2900317	PLC-RSC-12DC/21AU	2966919		X	
PLC-RPT-24DC/21AU	2900306	PLC-RSC-24DC/21AU	2966265	X	X	
PLC-RPT-24UC/21AU	2900307	PLC-RSC-24UC/21AU	2966278	X	X	
PLC-RPT-48DC/21AU	2900308	PLC-RSC-48DC/21AU	2966126		X	
PLC-RPT-60DC/21AU	2900309	PLC-RSC-60DC/21AU	2966142		X	
PLC-RPT-120UC/21AU	2900310	PLC-RSC-120UC/21AU	2966281		X	
PLC-RPT-230UC/21AU	2900311	PLC-RSC-230UC/21AU	2966294		X	
PLC-RPT-120UC/21/SO46	2900453 ³⁾	PLC-BSC-120UC/21/SO46	2980319 ³⁾		X	
PLC-RPT-230UC/21/SO46	2900455 ³⁾	PLC-BSC-230UC/21/SO46	2980335 ³⁾		X	
PLC-RPT-24DC/21-21	2900330	PLC-RSC-24DC/21-21	2967060			X
PLC-RPT-24DC/21-21AU	2900338	PLC-RSC-24DC/21-21AU	2967125			X
PLC-RPT-24UC/1/S/H	2900328	PLC-RSC-24UC/1/S/H	2982236	X		
PLC-RPT-24UC/1/S/L	2900327	PLC-RSC-24UC/1/S/L	2834876	X		
PLC-OPT-24DC/24DC/2	2900364	PLC-OSC-24DC/24DC/2	2966634	X		
PLC-OPT-24DC/24DC/10/R	2900398	PLC-OSC-24DC/24DC/10/R	2982702	X		
PLC-OPT-24DC/230AC/1	2900369	PLC-OSC-24DC/230AC/1	2967840	X		
PLC-OPT-24DC/300DC/1	2900383	PLC-OSC-24DC/300DC/1	2980678	X		
PLC-OPT-24DC/48DC/100	2900352	PLC-OSC-24DC/48DC/100	2966728	X	X	
PLC-OPT-48DC/48DC/100	2900353	PLC-OSC-48DC/48DC/100	2966993		X	
PLC-OPT-60DC/48DC/100	2900354	PLC-OSC-60DC/48DC/100	2967455		X	
PLC-OPT-120UC/48DC/100	2900355	PLC-OSC-120UC/48DC/100	2966744		X	
PLC-OPT-230UC/48DC/100	2900356	PLC-OSC-230UC/48DC/100	2966757		X	
PLC-PT-EIK 1-SVN 24P/P	2900397	PLC-SC-EIK 1-SVN 24P/P	2982663		X	
PLC-BPT-120UC/21/SO46	2900453 ³⁾	PLC-BSC-120UC/21/SO46	2980319 ³⁾		X	
PLC-BPT-230UC/21/SO46	2900455 ³⁾	PLC-BSC-230UC/21/SO46	2980335 ³⁾		X	
PLC-OPT-24DC/48DC/500/W	2900378	PLC-OSC-24DC/48DC/500/W	2980636	X		
-		PLC-VT	2296870	X	X	
-		PLC-VT/LA	2296854	X	X	
PLC-RPT-24DC/1/ACT	2900312	PLC-RSC-24DC/1/ACT	2966210	X		
PLC-RPT-24DC/11C/ACT	2900298	PLC-RSC-24DC/11C/ACT	2967604			X
-		PLC-RSC-24DC/1-1/ACT	2967109			X
PLC-OPT-24DC/24DC/2/ACT	2900376	PLC-OSC-24DC/24DC/2/ACT	2966676	X		
-		PLC-OSC-24DC/24DC/5/ACT	2982786			X
-		PLC-OSC-24DC/230AC/1/ACT	2967947	X		
-		PLC-OSC-24DC/230AC/2/ACT	2982760			X
-		PLC-VT/AKT	2295567	X		
-		PLC-VT/AKT/LA	2296867	X		
PLC-RPT-24DC/1AU/SEN	2900313	PLC-RSC-24DC/1AU/SEN	2966317		X	
PLC-RPT-120UC/1AU/SEN	2900314	PLC-RSC-120UC/1AU/SEN	2966320		X	
PLC-RPT-230UC/1AU/SEN	2900315	PLC-RSC-230UC/1AU/SEN	2966333		X	
PLC-BPT-120UC/1/SEN/SO46	2900456 ³⁾	PLC-BSC-120UC/1/SEN/SO46	2980322 ³⁾		X	
PLC-BPT-230UC/1/SEN/SO46	2900457 ³⁾	PLC-BSC-230UC/1/SEN/SO46	2980348 ³⁾		X	
PLC-OPT-24DC/48DC/100/SEN	2900358	PLC-OSC-24DC/48DC/100/SEN	2966773		X	
PLC-OPT-120UC/48DC/100/SEN	2900359	PLC-OSC-120UC/48DC/100/SEN	2966799		X	
PLC-OPT-230UC/48DC/100/SEN	2900361	PLC-OSC-230UC/48DC/100/SEN	2966809		X	
PLC-BPT-120UC/1/SEN/SO46	2900456 ³⁾	PLC-BSC-120UC/1/SEN/SO46	2980322 ³⁾		X	
PLC-BPT-230UC/1/SEN/SO46	2900457 ³⁾	PLC-BSC-230UC/1/SEN/SO46	2980348 ³⁾		X	

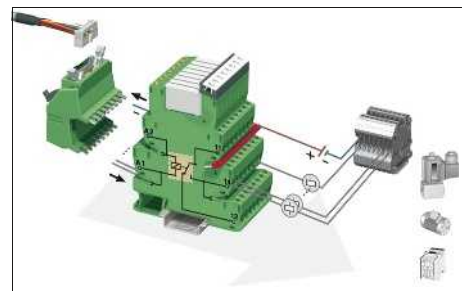

PLC universal series

The universal series of products can be used as either input or output interfaces. Each product consists of a basic terminal block with a plug-in miniature relay (PDT contact) or a plug-in solid-state relay.

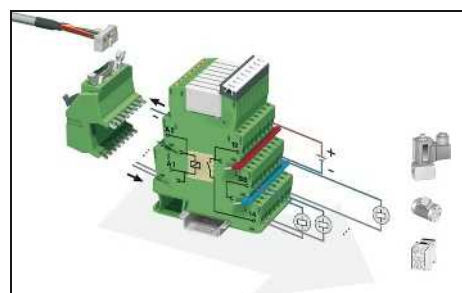

PLC actuator series

When used as an interface between the PLC and actuators, such as motors, contactors or solenoid valves, only one N/O contact function is normally required. In such cases, the PLC...ACT output interface is used. All actuator connections, including the load return line, are connected directly. This eliminates the need for additional output terminal blocks.

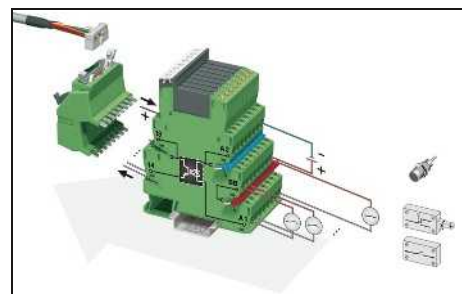

PLC sensor series

When used as an interface between the PLC and sensors, such as proximity switches, limit switches or auxiliary contacts, only one N/O contact function is normally required. In such cases, the PLC...SEN input interface is used. All sensor connections, including the supply voltage for the sensors/switches, are connected directly. This eliminates the need for additional modular terminal blocks.

System cabling for controllers

VARIOFACE system cabling

COMPACT-LINE output modules with relays, one N/O contact

These VARIOFACE Compact Line output modules are used in combination with the respective front adapters.

Like the front adapters, the modules are connected via 14-pos. or 50-pos. system cables. The following features characterize these relay modules:

- Plug-in miniature relays, each with an N/O contact
- Universal applications from 1 mA to 3 A continuous current through 2-layer double contact with hard gold plating
- Low construction height of only 45 mm
- LED status display for each signal path and supply voltage
- Freewheeling and reverse polarity protection diode for each signal path.

With the 32-channel version, the system cable is connected to the UM 45-16RM/MR-G24/1/PLC 16-channel base module.

The UM 45-16RM/MR-G24/1/E/PLC output extension module with a further 16 channels is coupled to the base module via a 20-pos. flat-ribbon cable (length: 10 cm).

Notes:

The connection cable between the base and the extension modules is delivered with the extension unit.

Due to the geometry, it is not possible to couple any molded FLK connectors (e.g., VIP-PA...S7).



Output module with eight miniature relays, 1 N/O contact

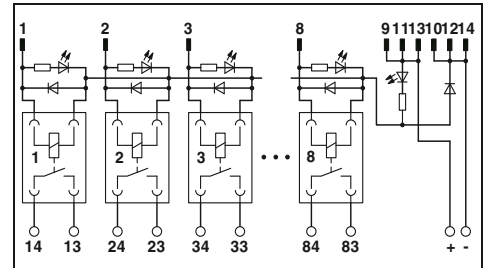

Technical data

Coil side		24 V DC
Operating voltage U_N		6.5 mA
Typ. input current at U_N		5 ms
Typ. response time at U_N		15 ms
Typ. release time at U_N		Freewheeling diode, Protection against polarity reversal
Input circuit		Yellow LED
Status display/channel		IDC/FLK pin strip (2.54 mm)
Connection method		14
No. of pos.		
Contact side		
Contact type		1 N/O contact (double contact)
Contact material		AgNi, 5 µm hard gold-plated
Max. switching voltage		250 V AC / 125 V DC
Min. switching voltage		5 V
Max. inrush current		5 A
Limiting continuous current		3 A
Min. switching current		1 mA
Max. interrupting rating:	24 V DC	72 W
	48 V DC	60 W
	60 V DC	50 W
	110 V DC	50 W
	250 V AC	750 VA
Connection method		Screw connection
Connection data solid / stranded / AWG		0.14 ... 1.5 mm ² / 0.14 ... 1.5 mm ² / 26 - 14
General data		
Test voltage		2 kV AC (50 Hz, 1 min.)
Ambient temperature (operation)		-20°C ... 50°C
Nominal operating mode		100% operating factor
Mechanical service life		2 x 10 ⁷ cycles
Standards/regulations		IEC 60664, DIN EN 50178, IEC 62103
Mounting position		Any
Mounting		In rows with zero spacing
Dimensions	H / D	45 mm / 50 mm

Ordering data

Description	Module width W	Type	Order No.	Pcs. / Pkt.
VARIOFACE COMPACT LINE output module, for 24 V DC (including relays)				
- With 8 miniature relays	103	UM 45- 8RM/MR-G24/1/PLC	2962900	1
- With 16 miniature relays	215			
VARIOFACE COMPACT LINE output extension module, for 24 V DC (including relays)				
- With 16 miniature relays	200			

Accessories

Plug-in miniature relays	REL-MR-G 24/1	2961037	8
---------------------------------	----------------------	----------------	----------

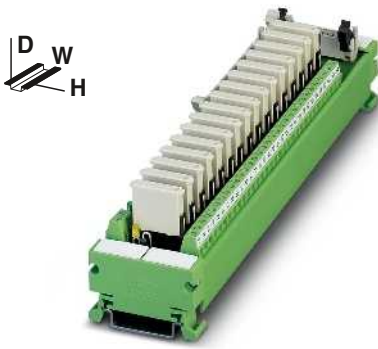

Output base module with 16 miniature relays,
1 N/O contact

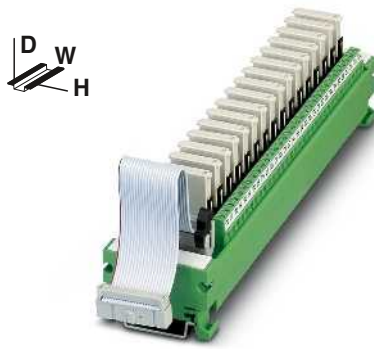

Output extension module with 16 miniature relays,
one N/O contact

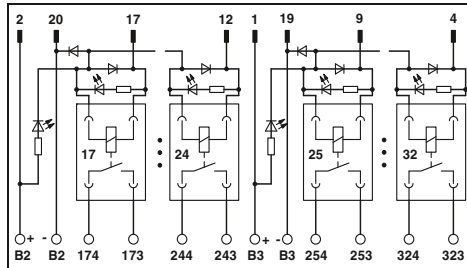
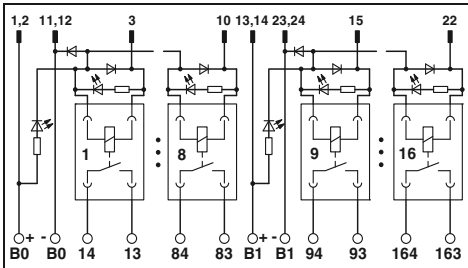

Technical data

Technical data

24 V DC
6.5 mA
5 ms
15 ms
Freewheeling diode, Protection against polarity reversal
Yellow LED
IDC/FLK pin strip (2.54 mm)
50

24 V DC
6.5 mA
5 ms
15 ms
Freewheeling diode, Protection against polarity reversal
Yellow LED
IDC/FLK pin strip (2.54 mm)
20

1 N/O contact (double contact)

1 N/O contact (double contact)

AgNi, 5 µm hard gold-plated
250 V AC / 125 V DC
5 V
5 A
3 A
1 mA
72 W
60 W
50 W
50 W
750 VA
Screw connection
0.14 ... 1.5 mm² / 0.14 ... 1.5 mm² / 26 - 14

AgNi, 5 µm hard gold-plated
250 V AC / 125 V DC
5 V
5 A
3 A
1 mA
72 W
60 W
50 W
50 W
750 VA
Screw connection
0.14 ... 1.5 mm² / 0.14 ... 1.5 mm² / 26 - 14

2 kV (50 Hz, 1 min.)
-20°C ... 50°C
100% operating factor
2 x 10⁷ cycles
IEC 60664, DIN EN 50178, IEC 62103
Any
In rows with zero spacing
45 mm / 50 mm

2 kV (50 Hz, 1 min.)
-20°C ... 50°C
100% operating factor
2 x 10⁷ cycles
IEC 60664, DIN EN 50178, IEC 62103
Any
In rows with zero spacing
45 mm / 50 mm

Ordering data

Ordering data

Type	Order No.	Pcs. / Pkt.
UM 45-16RM/MR-G24/1/PLC	2962913	1

Type	Order No.	Pcs. / Pkt.
UM 45-16RM/MR-G24/1/E/PLC	2962926	1

Accessories

Accessories

REL-MR-G 24/1	2961037	8
---------------	---------	---

REL-MR-G 24/1	2961037	8
---------------	---------	---

System cabling for controllers

VARIOFACE system cabling

Output modules with relays, one N/O contact

These VARIOFACE output modules are used in combination with the respective front adapters.

- Plug-in miniature relays, each with an N/O contact
- Universal applications from 1 mA to 3 A continuous current through 2-layer double contact with hard gold plating
- Slim construction widths of only 55 mm (8 channels) or 202 mm (32 channels)
- LED status display for each signal path and supply voltage
- Freewheeling and reverse polarity protection diode for each signal path.

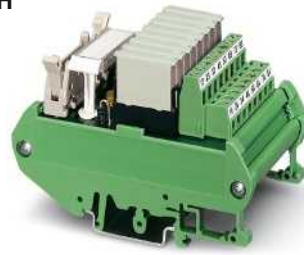

Output module with eight miniature relays, 1 N/O contact

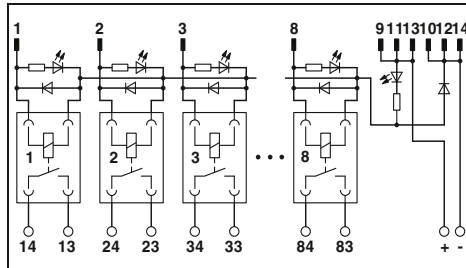

Technical data

Coil side	
Operating voltage U_N	24 V DC
Typ. input current at U_N	6.5 mA
Typ. response time at U_N	5 ms
Typ. release time at U_N	15 ms
Input circuit	Freewheeling diode, Protection against polarity reversal
Status display/channel	Yellow LED
Connection method	IDC/FLK pin strip (2.54 mm)
No. of pos.	14
Contact side	
Contact type	1 N/O contact (double contact)
Contact material	AgNi, 5 µm hard gold-plated
Max. switching voltage	250 V AC / 125 V DC
Min. switching voltage	5 V
Max. inrush current	5 A
Limiting continuous current	3 A
Min. switching current	1 mA
Max. interrupting rating:	24 V DC 72 W 48 V DC 60 W 60 V DC 50 W 110 V DC 50 W 250 V AC 750 VA
Connection method	Screw connection
Connection data solid / stranded / AWG	0.14 ... 1.5 mm ² / 0.14 ... 1.5 mm ² / 26 - 14
General data	
Test voltage	3 kV AC
Ambient temperature (operation)	-20°C ... 50°C
Nominal operating mode	100% operating factor
Mechanical service life	2 x 10 ⁷ cycles
Standards/regulations	IEC 60664, DIN EN 50178, IEC 62103
Mounting position	Any
Mounting	In rows with zero spacing
Dimensions	90 mm / 58 mm

Ordering data

Description	Module width W
VARIOFACE output module, with 8 miniature relays, plugged in, for 24 V DC (including relays)	56
VARIOFACE output module, with 32 miniature relays, plugged in, for 24 V DC (including relays)	202

Accessories

Plug-in miniature relays	REL-MR-G 24/1	2961037	8
--------------------------	---------------	---------	---

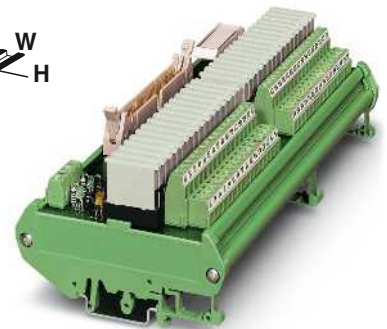

Output modules with 32 miniature relays, 1 N/O contact

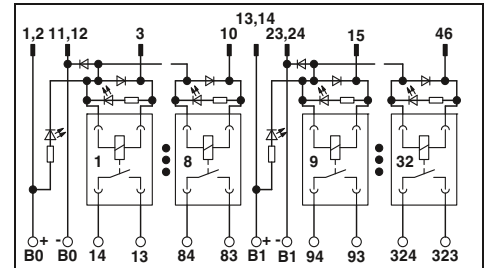

Technical data

Coil side	
Operating voltage U_N	24 V DC
Typ. input current at U_N	6.5 mA
Typ. response time at U_N	5 ms
Typ. release time at U_N	15 ms
Input circuit	Freewheeling diode, Protection against polarity reversal
Status display/channel	Yellow LED
Connection method	IDC/FLK pin strip (2.54 mm)
No. of pos.	50
Contact side	
Contact type	1 N/O contact (double contact)
Contact material	AgNi, 5 µm hard gold-plated
Max. switching voltage	250 V AC / 125 V DC
Min. switching voltage	5 V
Max. inrush current	5 A
Limiting continuous current	3 A
Min. switching current	1 mA
Max. interrupting rating:	24 V DC 72 W 48 V DC 60 W 60 V DC 50 W 110 V DC 50 W 250 V AC 750 VA
Connection method	Screw connection
Connection data solid / stranded / AWG	0.14 ... 1.5 mm ² / 0.14 ... 1.5 mm ² / 26 - 14
General data	
Test voltage	3 kV AC
Ambient temperature (operation)	-20°C ... 50°C
Nominal operating mode	100% operating factor
Mechanical service life	2 x 10 ⁷ cycles
Standards/regulations	IEC 60664, DIN EN 50178, IEC 62103
Mounting position	Any
Mounting	In rows with zero spacing
Dimensions	90 mm / 58 mm

Ordering data

Type	Order No.	Pcs. / Pkt.
UMK-8 RM/MR-G24/ 1/PLC	2979469	1
UMK-32 RM/MR-G24/1/PLC	2979472	1

Accessories

Plug-in miniature relays	REL-MR-G 24/1	2961037	8
--------------------------	---------------	---------	---

Output modules with relay, 1 PDT

These VARIOFACE output modules are used in combination with the respective front adapters.

Like the front adapters, the modules are connected via 14-pos. or 50-pos. system cables. The following features characterize these relay modules:

- Plug-in miniature relays, each with a PDT contact
- Slim construction widths of only 80 mm (8 channels) or 271 mm (32 channels)
- LED status display for each signal path and supply voltage
- Freewheeling diode for each signal path



Output module with eight miniature relays, 1 PDT

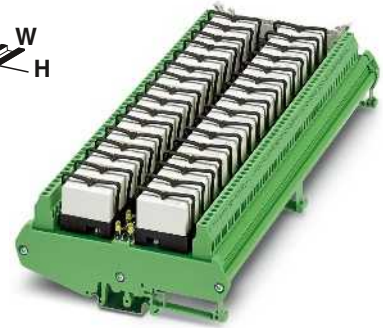

Output module with 32 miniature relays, 1 PDT

Notes:
1) EMC: Class A product, see page 571

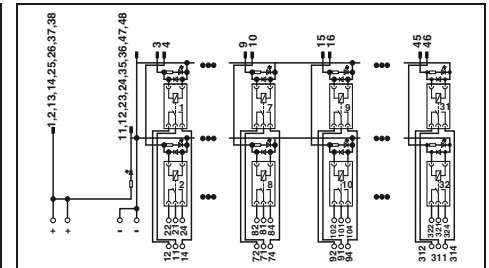
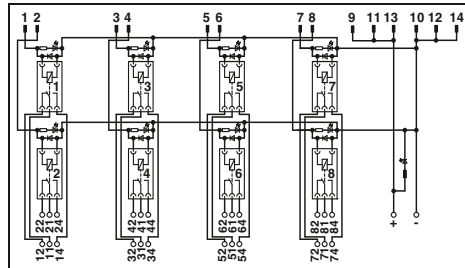

Coil side	
Operating voltage U_N	24 V DC
Typ. input current at U_N	18 mA
Typ. response time at U_N	8 ms
Typ. release time at U_N	10 ms
Input circuit	Freewheeling diode
Status display/channel	Yellow LED
Connection method	IDC/FLK pin strip (2.54 mm)
No. of pos.	14
Contact side	
Contact type	Single contact, 1-PDT
Contact material	AgNi
Max. switching voltage	250 V AC/DC
Min. switching voltage	12 V AC/DC
Limiting continuous current	5 A
Min. switching current	100 mA
Max. interrupting rating:	24 V DC 120 W 48 V DC 58 W 60 V DC 48 W 110 V DC 50 W 220 V DC 80 W 250 V AC 1250 VA
Connection method	Screw connection
Connection data solid / stranded / AWG	0.2 ... 4 mm ² / 0.2 ... 2.5 mm ² / 24 - 12
General data	
Test voltage	2.5 kV (50 Hz, 1 min.)
Ambient temperature (operation)	-20°C ... 50°C
Nominal operating mode	100% operating factor
Mechanical service life	3 x 10 ⁷ cycles
Standards/regulations	IEC 60664, DIN EN 50178, IEC 62103
Mounting position	Any
Mounting	In rows with zero spacing
Dimensions	123 mm / 68 mm

Technical data

Technical data	
Operating voltage U_N	24 V DC
Typ. input current at U_N	18 mA
Typ. response time at U_N	8 ms
Typ. release time at U_N	10 ms
Input circuit	Freewheeling diode
Status display/channel	Yellow LED
Connection method	IDC/FLK pin strip (2.54 mm)
No. of pos.	50
Contact side	
Contact type	Single contact, 1-PDT
Contact material	AgNi
Max. switching voltage	250 V AC/DC
Min. switching voltage	12 V AC/DC
Limiting continuous current	5 A
Min. switching current	100 mA
Max. interrupting rating:	120 W 58 W 48 W 50 W 80 W 1250 VA
Connection method	Screw connection
Connection data solid / stranded / AWG	0.2 ... 4 mm ² / 0.2 ... 2.5 mm ² / 24 - 12
General data	
Test voltage	2.5 kV (50 Hz, 1 min.)
Ambient temperature (operation)	-20°C ... 50°C
Nominal operating mode	100% operating factor
Mechanical service life	3 x 10 ⁷ cycles
Standards/regulations	IEC 60664, DIN EN 50178, IEC 62103
Mounting position	Any
Mounting	In rows with zero spacing
Dimensions	123 mm / 68 mm

Technical data

Technical data	
Operating voltage U_N	24 V DC
Typ. input current at U_N	18 mA
Typ. response time at U_N	8 ms
Typ. release time at U_N	10 ms
Input circuit	Freewheeling diode
Status display/channel	Yellow LED
Connection method	IDC/FLK pin strip (2.54 mm)
No. of pos.	50
Contact side	
Contact type	Single contact, 1-PDT
Contact material	AgNi
Max. switching voltage	250 V AC/DC
Min. switching voltage	12 V AC/DC
Limiting continuous current	5 A
Min. switching current	100 mA
Max. interrupting rating:	120 W 58 W 48 W 50 W 80 W 1250 VA
Connection method	Screw connection
Connection data solid / stranded / AWG	0.2 ... 4 mm ² / 0.2 ... 2.5 mm ² / 24 - 12
General data	
Test voltage	2.5 kV (50 Hz, 1 min.)
Ambient temperature (operation)	-20°C ... 50°C
Nominal operating mode	100% operating factor
Mechanical service life	3 x 10 ⁷ cycles
Standards/regulations	IEC 60664, DIN EN 50178, IEC 62103
Mounting position	Any
Mounting	In rows with zero spacing
Dimensions	123 mm / 68 mm

Description	Module width W
VARIOFACE output module, with 8 miniature relays, plugged in, for 24 V DC (including relays)	80
VARIOFACE output module, with 32 miniature relays, plugged in, for 24 V DC (including relays)	271

Ordering data		
Type	Order No.	Pcs. / Pkt.
UM- 8 RM/RT-G24/21/PLC	2968386	1

Ordering data		
Type	Order No.	Pcs. / Pkt.
UM-32 RM/RT-G24/21/PLC ¹⁾	2968373	1

Accessories	
Plug-in miniature relays	REL-MR- 24DC/21HC

Accessories		
Type	Order No.	Pcs. / Pkt.
REL-MR- 24DC/21HC	2961312	10

Accessories		
Type	Order No.	Pcs. / Pkt.
REL-MR- 24DC/21HC	2961312	10

System cabling for controllers

VARIOFACE system cabling

Output modules with relay, 1 PDT

These VARIOFACE output modules are used in combination with the respective front adapters.

Like the front adapters, the modules are connected via 14-pos. or 50-pos. system cables. The following features characterize these relay modules:

- Plug-in miniature relays, each with a PDT contact
- LED status display for each signal path and supply voltage
- Freewheeling and reverse polarity protection diode for each signal path.

With the 32-channel version, the system cable is connected to the 16-channel UMK-16R.../KSR-G24/21/PLC base module. The UMK-16R.../KSR-G24/21/E/PLC output extension module with a further 16 channels is coupled to the base module via a 20-pos. flat-ribbon cable (length: 10 cm).

Notes:

The connection cable between the base and the extension modules is delivered with the extension unit.

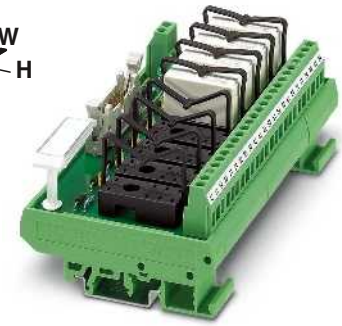

Output module with eight miniature relays, 1 PDT

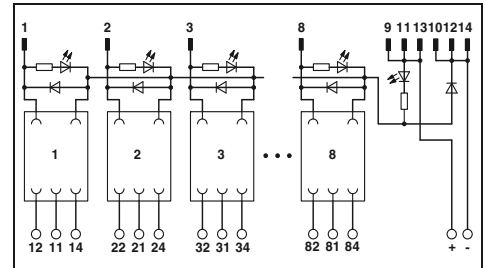

Technical data

Coil side	
Operating voltage U_N	24 V DC $\pm 10\%$
Input circuit	Freewheeling diode, Protection against polarity reversal
Operating voltage display	Green LED
Status display/channel	Yellow LED
Connection method	IDC/FLK pin strip (2.54 mm)
No. of pos.	14
Contact side	
Contact type	1 PDT
Max. switching voltage	250 V AC/DC
Limiting continuous current	5 A
Connection method	Screw connection
Connection data solid / stranded / AWG	0.2 ... 4 mm ² / 0.2 ... 2.5 mm ² / 24 - 12
General data	
Test voltage	2.5 kV (50 Hz, 1 min.)
Ambient temperature (operation)	-20°C ... 50°C
Standards/regulations	IEC 60664, DIN EN 50178, IEC 62103
Mounting position	Any
Mounting	In rows with zero spacing
Dimensions	77 mm / 59 mm

Ordering data

Description	Module width W	Type	Order No.	Pcs. / Pkt.
VARIOFACE output module, with 8 miniature relays, plugged in, for 24 V DC (including relays)	135	UMK- 8 RM/KSR-G 24/21/PLC	2979485	1
VARIOFACE output module, with plug-in bases for eight miniature relays, for 24 V DC (without relays)	135	UMK- 8 RELS/KSR-G24/21/PLC	2974914	1
VARIOFACE output module, with 16 miniature relays, plugged in, for 24 V DC (base module, including relays)	259			
VARIOFACE output module, with plug-in bases for 16 miniature relays, for 24 V DC (base module, without relays)	259			
VARIOFACE output extension module, with 16 miniature relays, plugged in, for 24 V DC (including relays)	259			
VARIOFACE output extension module, with plug-in bases for 16 miniature relays, for 24 V DC (without relays)	259			

Accessories

Plug-in miniature relays	REL-MR- 24DC/21HC	2961312	10
--------------------------	-------------------	---------	----

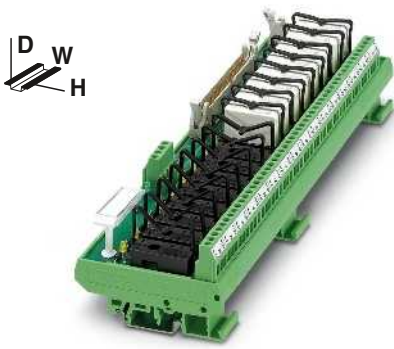

Output base module with 16 miniature relays,
1 PDT

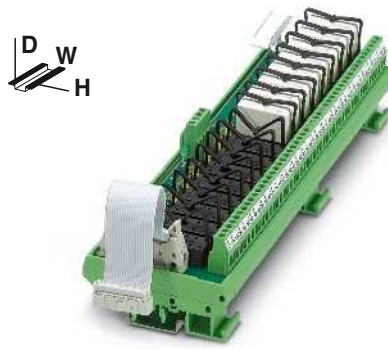

Output extension module with 16 miniature relays,
1 PDT

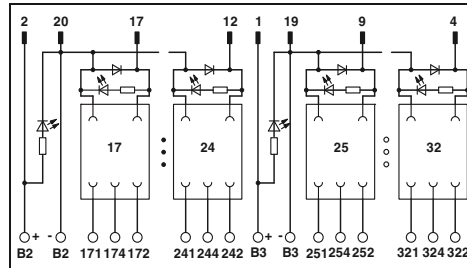
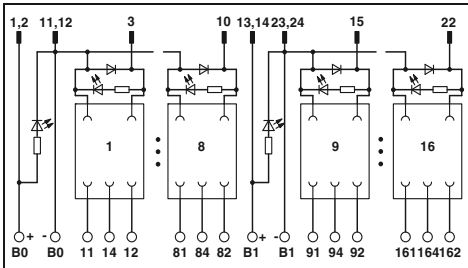

Technical data

24 V DC $\pm 10\%$
 Freewheeling diode, Protection against polarity reversal
 Green LED
 Yellow LED
 IDC/FLK pin strip (2.54 mm)
 50

1 PDT
 250 V AC/DC
 5 A
 Screw connection
 0.2 ... 4 mm² / 0.2 ... 2.5 mm² / 24 - 12

2.5 kV (50 Hz, 1 min.)
 -20°C ... 50°C
 IEC 60664, DIN EN 50178, IEC 62103
 Any
 In rows with zero spacing
 77 mm / 59 mm

Ordering data

Type	Order No.	Pcs. / Pkt.
UMK-16 RM/KSR-G 24/21/PLC	2979498	1
UMK-16 RELS/KSR-G24/21/PLC	2974901	1

Accessories

REL-MR- 24DC/21HC	2961312	10
-------------------	---------	----

Technical data

24 V DC $\pm 10\%$
 Freewheeling diode, Protection against polarity reversal
 Green LED
 Yellow LED
 IDC/FLK pin strip (2.54 mm)
 20

1 PDT
 250 V AC/DC
 5 A
 Screw connection
 0.2 ... 4 mm² / 0.2 ... 2.5 mm² / 24 - 12

2.5 kV (50 Hz, 1 min.)
 -20°C ... 50°C
 IEC 60664, DIN EN 50178, IEC 62103
 Any
 In rows with zero spacing
 77 mm / 59 mm

Ordering data

Type	Order No.	Pcs. / Pkt.
UMK-16 RM/KSR-G 24/21/E/PLC	2979508	1
UMK-16 RELS/KSR-G24/21/E/PLC	2974891	1

Accessories

REL-MR- 24DC/21HC	2961312	10
-------------------	---------	----

System cabling for controllers

VARIOFACE system cabling

Output module for relays

- 2 PDTs
- 1 PDT with disconnect terminal blocks

These VARIOFACE output modules are used in combination with the respective front adapters.

8 channels are controlled via 14-pos. cables. All modules feature the following:

- Plug-in miniature relays
- LED status indicator and freewheeling diode per signal path
- Supply voltage indicator (LED)
- Polarity protection diode

With the 32-channel version (1 PDT with knife disconnect terminal blocks), the 50-pos. system cable is connected to the base module with 16 channels.

The output extension module with a further 16 channels is coupled to the base module via a 20-pos. flat-ribbon cable (length: 10 cm).

Notes:

The connection cable between the base and the extension modules is delivered with the extension unit.

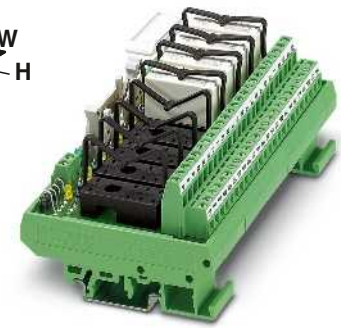

Output module for 8 miniature relays, 2 PDTs

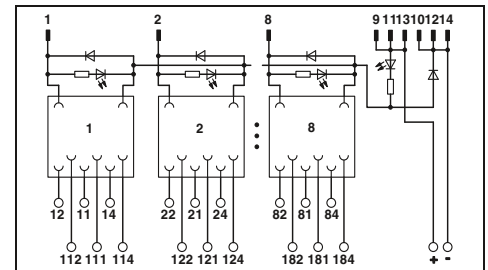

Technical data

Coil side	
Operating voltage U_N	24 V DC
Input circuit	Freewheeling diode
Operating voltage display	Green LED
Status display/channel	Yellow LED
Connection method	IDC/FLK pin strip (2.54 mm)
No. of pos.	14
Contact side	
Contact type	2 PDT
Max. switching voltage	250 V AC/DC
Limiting continuous current	3 A
Connection method	Screw connection
Connection data solid / stranded / AWG	0.14 ... 1.5 mm ² / 0.14 ... 1.5 mm ² / 26 - 14
General data	
Test voltage	2.5 kV AC
Ambient temperature (operation)	-20°C ... 50°C
Standards/regulations	IEC 60664, DIN EN 50178, IEC 62103
Mounting position	Any
Mounting	In rows with zero spacing
Dimensions	77 mm / 59 mm

Ordering data

Description	Module width W	Type	Order No.	Pcs. / Pkt.
VARIOFACE output module, with plug-in bases for eight miniature relays, for 24 V DC, each with two PDTs (without relays)	135	UMK- 8 RELS/KSR-G24/21-21/PLC	2976187	1
VARIOFACE output module, with plug-in bases for 8 miniature relays, for 24 V DC and knife disconnect terminal blocks, each with 1 PDT (without relays)	145			
VARIOFACE output module, with plug-in bases for 16 miniature relays, for 24 V DC and knife disconnect terminal blocks, each with 1 PDT (without relays)	285			
VARIOFACE output extension module, with plug-in bases for 16 miniature relays, for 24 V DC and knife disconnect terminal blocks, each with 1 PDT (without relays)	285			

Accessories

Plug-in miniature relays	REL-MR- 24DC/21-21	2961192	10
--------------------------	--------------------	---------	----

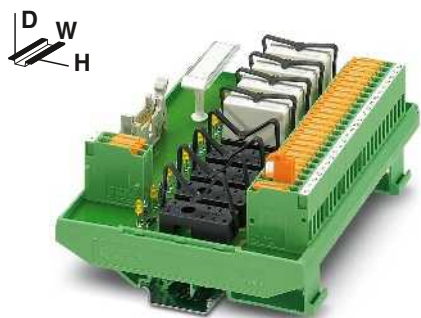

Output module for 8 miniature relays with knife/disconnect terminal blocks, 1 PDT

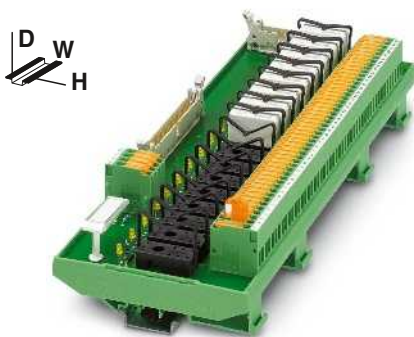

Output module for 16 miniature relays with knife/disconnect terminal blocks, 1 PDT

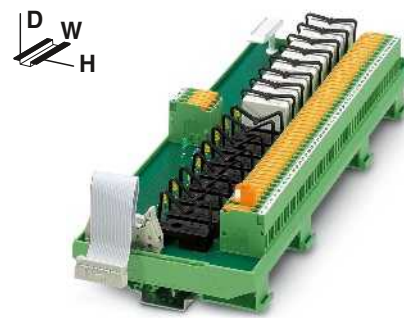

Output extension module for 16 miniature relays with knife/disconnect terminal blocks, 1 PDT

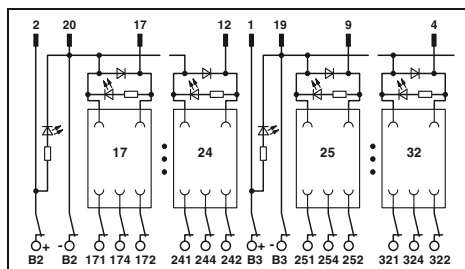
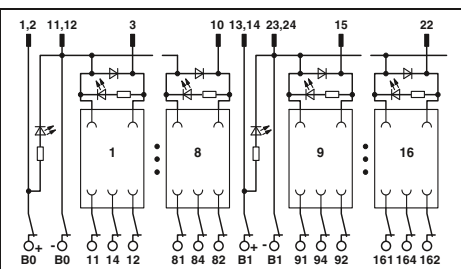
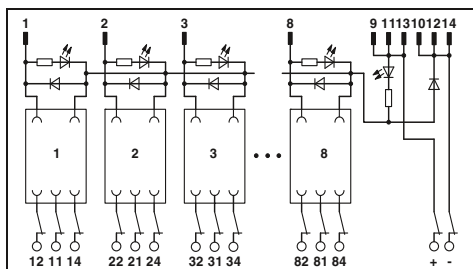

Technical data

24 V DC
 Freewheeling diode, Protection against polarity reversal
 Green LED
 Yellow LED
 IDC/FLK pin strip (2.54 mm)
 14

1 PDT
 250 V AC/DC
 5 A
 Screw connection with disconnect knife
 0.2 ... 4 mm² / 0.2 ... 2.5 mm² / 24 - 12

2.5 kV (50 Hz, 1 min.)
 -20°C ... 50°C
 IEC 60664, DIN EN 50178, IEC 62103
 Any
 In rows with zero spacing
 111.5 mm / 59 mm

Ordering data

Type	Order No.	Pcs. / Pkt.
UM-8 RELS/KSR-G24/21/MT/PLC	2962463	1

Accessories

REL-MR-24DC/21-21	2961192	10
-------------------	---------	----

Technical data

24 V DC
 Freewheeling diode
 Green LED
 Yellow LED
 IDC/FLK pin strip (2.54 mm)
 50

1 PDT
 250 V AC/DC
 5 A
 Screw connection with disconnect knife
 0.2 ... 4 mm² / 0.2 ... 2.5 mm² / 24 - 12

2.5 kV (50 Hz, 1 min.)
 -20°C ... 50°C
 IEC 60664, DIN EN 50178, IEC 62103
 Any
 In rows with zero spacing
 111.5 mm / 59 mm

Ordering data

Type	Order No.	Pcs. / Pkt.
UM-16 RELS/KSR-G24/21/MT/PLC	2962382	1

Accessories

REL-MR-24DC/21-21	2961192	10
-------------------	---------	----

Technical data

24 V DC
 Freewheeling diode
 Green LED
 Yellow LED
 IDC/FLK pin strip (2.54 mm)
 20

1 PDT
 250 V AC/DC
 5 A
 Screw connection with disconnect knife
 0.2 ... 4 mm² / 0.2 ... 2.5 mm² / 24 - 12

2.5 kV (50 Hz, 1 min.)
 -20°C ... 50°C
 IEC 60664, DIN EN 50178, IEC 62103
 Any
 In rows with zero spacing
 111.5 mm / 59 mm

Ordering data

Type	Order No.	Pcs. / Pkt.
UM-16 RELS/KSR-G24/21/E/MT/PLC	2962379	1

Accessories

REL-MR-24DC/21-21	2961192	10
-------------------	---------	----

System cabling for controllers

VARIOFACE system cabling

Output modules with relays, 1 PDT with detectable manual operation

These VARIOFACE output modules are used in combination with the respective front adapters.

The modules are connected via a 14- or 50-pos. system cable. These relay modules offer the following features:

- Plug-in miniature relays each with a PDT contact and detectable manual operation
- Slim design width of just 92 mm (8 channels) or 285 mm (32 channels)
- LED status indicator and freewheeling diode per signal path (integrated in relay)
- Supply voltage indicator (LED)



Output module with 8 miniature relays,
1 PDT with detectable manual operation

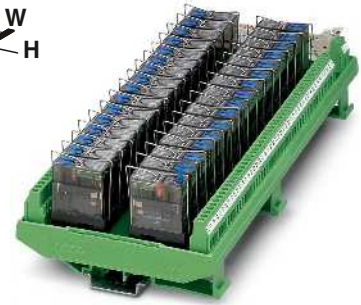

Output module with 32 miniature relays,
1 PDT with detectable manual operation

Notes:
1) EMC: Class A product, see page 571

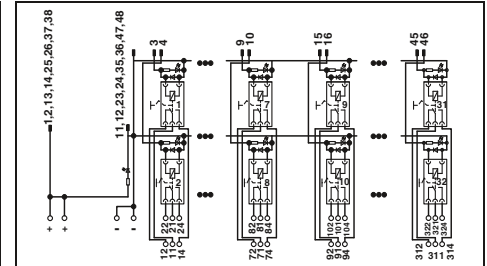
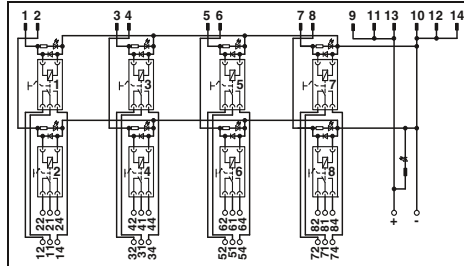

Coil side	
Operating voltage U_N	24 V DC
Typ. input current at U_N	18 mA
Typ. response time at U_N	9 ms
Typ. release time at U_N	6 ms
Input circuit	Freewheeling diode (integrated in relay)
Status display/channel	Yellow LED (integrated in relay)
Connection method	Flat-ribbon cable plug-in connector according to IEC 60603-13
No. of pos.	
14	
Contact side	
Contact type	Single contact, 1-PDT
Contact material	AgNi
Max. switching voltage	250 V AC/DC
Min. switching voltage	12 V AC/DC
Limiting continuous current	5 A
Min. switching current	100 mA
Max. interrupting rating:	24 V DC 120 W 48 V DC 62 W 60 V DC 42 W 110 V DC 55 W 220 V DC 66 W 250 V AC 1250 VA
Connection method	Screw connection
Connection data solid / stranded / AWG	0.2 ... 4 mm ² / 0.2 ... 2.5 mm ² / 24 - 12
General data	
Rated insulation voltage	260 V AC
Rated surge voltage	4 kV
Pollution degree / Surge voltage category	2 / III
Ambient temperature (operation)	-20°C ... 50°C
Nominal operating mode	100% operating factor
Mechanical service life	5 x 10 ⁶ cycles
Standards/regulations	DIN EN 50178
Mounting position	Any
Mounting	In rows with zero spacing
Dimensions	111 mm / 64 mm

Technical data		
24 V DC		
18 mA		
9 ms		
6 ms		
Freewheeling diode (integrated in relay)		
Yellow LED (integrated in relay)		
Flat-ribbon cable plug-in connector according to IEC 60603-13		
14		
Single contact, 1-PDT		
AgNi		
250 V AC/DC		
12 V AC/DC		
5 A		
100 mA		
24 V DC 120 W		
48 V DC 62 W		
60 V DC 42 W		
110 V DC 55 W		
220 V DC 66 W		
250 V AC 1250 VA		
Screw connection		
0.2 ... 4 mm ² / 0.2 ... 2.5 mm ² / 24 - 12		
260 V AC		
4 kV		
2 / III		
-20°C ... 50°C		
100% operating factor		
5 x 10 ⁶ cycles		
DIN EN 50178		
Any		
In rows with zero spacing		
111 mm / 64 mm		

Technical data		
24 V DC		
18 mA		
9 ms		
6 ms		
Freewheeling diode (integrated in relay)		
Yellow LED (integrated in relay)		
Flat-ribbon cable plug-in connector according to IEC 60603-13		
50		
Single contact, 1-PDT		
AgNi		
250 V AC/DC		
12 V AC/DC		
5 A		
100 mA		
24 V DC 120 W		
48 V DC 62 W		
60 V DC 42 W		
110 V DC 55 W		
220 V DC 66 W		
250 V AC 1250 VA		
Screw connection		
0.2 ... 4 mm ² / 0.2 ... 2.5 mm ² / 24 - 12		
260 V AC		
4 kV		
2 / III		
-20°C ... 50°C		
100% operating factor		
5 x 10 ⁶ cycles		
DIN EN 50178		
Any		
In rows with zero spacing		
111 mm / 64 mm		

Description	Module width W
VARIOFACE output module, with 8 miniature relays, plugged in, for 24 V DC (including relays)	92
VARIOFACE output module, with 32 miniature relays, plugged in, for 24 V DC (including relays)	285

Ordering data		
Type	Order No.	Pcs. / Pkt.
UM- 8RM/KSR-G24/21/MS/PLC ¹⁾	2900890	1

Ordering data		
Type	Order No.	Pcs. / Pkt.
UM-32RM/KSR-G24/21/MS/PLC ¹⁾	2900891	1

Accessories	
Plug-in miniature power relays, with power contacts	REL-MR- 24DC/21HC/MS

REL-MR- 24DC/21HC/MS	2987888	10
----------------------	---------	----

Accessories		
REL-MR- 24DC/21HC/MS	2987888	10

**Output modules with relays,
1 PDT with or without manual
operation and fuses**

These VARIOFACE output modules are used in combination with the respective front adapters.

The modules are connected via a 14-pos. system cable. These relay modules offer the following features:

- Plug-in miniature relays each with a PDT contact with or without manual operation
- Fuse per output circuit as short-circuit protection
- Slim design width of just 127 mm
- LED status indicator and freewheeling diode per signal path
- Supply voltage indicator (LED)
- Polarity protection diode



**Output module with 8 miniature relays,
1 PDT and fuse per output circuit**



**Output module with 8 miniature relays,
1 PDT with detectable manual operation
and fuse per output circuit**

Notes:
1) EMC: Class A product, see page 571

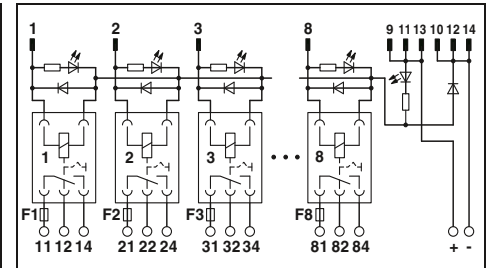
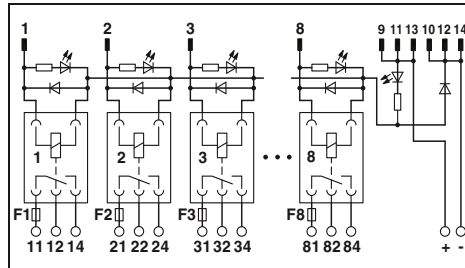

Coil side	
Operating voltage U_N	24 V DC
Typ. input current at U_N	17 mA
Typ. response time at U_N	8 ms
Typ. release time at U_N	10 ms
Input circuit	Freewheeling diode
Status display/channel	Yellow LED
Connection method	Flat-ribbon cable plug-in connector according to IEC 60603-13
No. of pos.	
14	
Contact side	
Single contact, 1-PDT	
Contact type	AgNi
Contact material	250 V AC/DC
Max. switching voltage	12 V AC/DC
Min. switching voltage	4 A 5x20 fuse (slow-blow)
Output fuse	3.9 A (observe derating)
Limiting continuous current	100 mA
Min. switching current	93 W
Max. interrupting rating:	48 V DC
	58 W
	60 V DC
	48 W
	110 V DC
	50 W
	220 V DC
	80 W
	250 V AC
	975 VA
Connection method	Screw connection
Connection data solid / stranded / AWG	0.2 ... 4 mm ² / 0.2 ... 2.5 mm ² / 24 - 12
General data	
Rated insulation voltage	260 V AC
Rated surge voltage	4 kV
Pollution degree / Surge voltage category	2 / III
Ambient temperature (operation)	-20°C ... 50°C
Nominal operating mode	100% operating factor
Mechanical service life	3 x 10 ⁷ cycles
Standards/regulations	DIN EN 50178
Mounting position	Any
Mounting	In rows with zero spacing
Dimensions	111 mm / 60 mm

Technical data

Technical data	
24 V DC	
17 mA	
8 ms	
10 ms	
Freewheeling diode	
Yellow LED	
Flat-ribbon cable plug-in connector according to IEC 60603-13	
No. of pos.	
14	
Contact side	
Single contact, 1-PDT	
AgNi	
250 V AC/DC	
12 V AC/DC	
4 A 5x20 fuse (slow-blow)	
3.9 A (observe derating)	
100 mA	
93 W	
48 V DC	
58 W	
60 V DC	
48 W	
110 V DC	
50 W	
220 V DC	
80 W	
250 V AC	
975 VA	
Screw connection	
0.2 ... 4 mm ² / 0.2 ... 2.5 mm ² / 24 - 12	

Technical data

Technical data	
24 V DC	
18 mA	
9 ms	
6 ms	
Freewheeling diode (integrated in relay)	
Yellow LED (integrated in relay)	
Flat-ribbon cable plug-in connector according to IEC 60603-13	
No. of pos.	
14	
Contact side	
Single contact, 1-PDT	
AgNi	
250 V AC/DC	
12 V AC/DC	
4 A 5x20 fuse (slow-blow)	
3.9 A (observe derating)	
100 mA	
93 W	
62 W	
42 W	
55 W	
66 W	
975 VA	
Screw connection	
0.2 ... 4 mm ² / 0.2 ... 2.5 mm ² / 24 - 12	

Description	Module width W
VARIOFACE output module, with 8 miniature relays, plugged in, for 24 V DC (including relays)	127

Ordering data

Type	Order No.	Pcs. / Pkt.
UM- 8RM/KSR-G24/21/SI/PLC ¹⁾	2900892	1

Ordering data

Type	Order No.	Pcs. / Pkt.
UM- 8RM/KSR-G24/21/MS/SI/PLC ¹⁾	2900893	1

Accessories

Plug-in miniature relays	
--------------------------	--

Accessories

REL-MR- 24DC/21HC	2961312	10
-------------------	---------	----

Accessories

REL-MR- 24DC/21HC/MS	2987888	10
----------------------	---------	----

System cabling for controllers

VARIOFACE system cabling

VIP – VARIOFACE Professional system cables with flat-ribbon connectors

- 1:1 connection
- 10- to 20-pos.
- Plug-in connectors as per IEC 60603-13
- In the desired lengths
- Individual serial number

Note:

Due to the enlarged outer contour of the molded plug-in connectors, module types with UM45 profile and three-level terminal blocks cannot be connected with the VIP-CAB-FLK... system cable.

The following module types (10- to 50-pos.) can be connected.

For example, for 20 positions:

- VIP-2/SC/FLK 20
- VIP-2/SC/FLK20/LED
- FLKM 20/ZFKDS
- UM45-FLK 20/ZFKDS

(double-level connection)

The VIP-CAB-FLK... system cables are not suitable for front adapters (see the dimensional drawing).

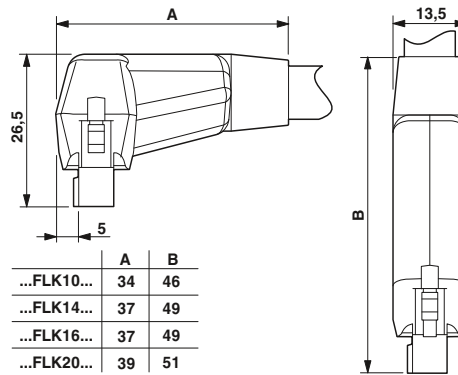

not shielded



Technical data

Max. perm. operating voltage
 Max. perm. current carrying capacity per path
 Max. conductor resistance
 Ambient temperature (operation)
 Assembly

< 50 V AC / 60 V DC
 1 A
 0.16 Ω/m
 -20°C ... 50°C
 Insulation displacement, IEC 60352-4/DIN EN 60352-4

Conductor cross section
 Outside diameter

AWG 26 / 0.14 mm²

10 -position 6.1 mm
 14 -position 6.4 mm
 16 -position 6.8 mm
 20 -position 7.6 mm

Ordering data

Description	No. of pos.	Cable length	Type	Order No.	Pcs. / Pkt.
Round cable, with two molded socket strips					
	10	0.5 m	VIP-CAB-FLK10/0,14/0,5M	2318305	1
	10	1 m	VIP-CAB-FLK10/0,14/1,0M	2318318	1
	10	1.5 m	VIP-CAB-FLK10/0,14/1,5M	2318321	1
	10	2 m	VIP-CAB-FLK10/0,14/2,0M	2318334	1
	10	3 m	VIP-CAB-FLK10/0,14/3,0M	2318347	1
	10	4 m	VIP-CAB-FLK10/0,14/4,0M	2318350	1
	10	6 m	VIP-CAB-FLK10/0,14/6,0M	2318363	1
Round cable, same as before, in variable lengths (minimum ordering quantity five pieces)					
	10		VIP-CAB-FLK10-0,14/...	2318376	1
Round cable, with two molded socket strips					
	14	0.5 m	VIP-CAB-FLK14/0,14/0,5M	2318389	1
	14	1 m	VIP-CAB-FLK14/0,14/1,0M	2318392	1
	14	1.5 m	VIP-CAB-FLK14/0,14/1,5M	2318402	1
	14	2 m	VIP-CAB-FLK14/0,14/2,0M	2318415	1
	14	3 m	VIP-CAB-FLK14/0,14/3,0M	2318428	1
	14	4 m	VIP-CAB-FLK14/0,14/4,0M	2318431	1
	14	6 m	VIP-CAB-FLK14/0,14/6,0M	2318444	1
Round cable, same as before, in variable lengths (minimum ordering quantity five pieces)					
	14		VIP-CAB-FLK14-0,14/...	2318457	1
Round cable, with two molded socket strips					
	16	0.5 m	VIP-CAB-FLK16/0,14/0,5M	2318460	1
	16	1 m	VIP-CAB-FLK16/0,14/1,0M	2318473	1
	16	1.5 m	VIP-CAB-FLK16/0,14/1,5M	2318486	1
	16	2 m	VIP-CAB-FLK16/0,14/2,0M	2318499	1
	16	3 m	VIP-CAB-FLK16/0,14/3,0M	2318509	1
	16	4 m	VIP-CAB-FLK16/0,14/4,0M	2318512	1
	16	6 m	VIP-CAB-FLK16/0,14/6,0M	2318525	1
Round cable, same as before, in variable lengths (minimum ordering quantity five pieces)					
	16		VIP-CAB-FLK16-0,14/...	2318538	1
Round cable, with two molded socket strips					
	20	0.5 m	VIP-CAB-FLK20/0,14/0,5M	2318541	1
	20	1 m	VIP-CAB-FLK20/0,14/1,0M	2318554	1
	20	1.5 m	VIP-CAB-FLK20/0,14/1,5M	2318567	1
	20	2 m	VIP-CAB-FLK20/0,14/2,0M	2318570	1
	20	3 m	VIP-CAB-FLK20/0,14/3,0M	2318583	1
	20	4 m	VIP-CAB-FLK20/0,14/4,0M	2318596	1
	20	6 m	VIP-CAB-FLK20/0,14/6,0M	2318606	1
Round cable, same as before, in variable lengths (minimum ordering quantity five pieces)					
	20		VIP-CAB-FLK20-0,14/...	2318619	1

Ordering example for system cable:

– 10-pos. cable, 7.6 m long

Quantity	Order No.	Length [m]
1	2318376	7.6
		Min. 0.5 m
		Max. 100.0 m
		Step width 0.1 m

VIP – VARIOFACE Professional system cables with flat-ribbon plug-in connectors

- 1:1 connection
- 26- to 50-pos.
- Plug-in connectors as per IEC 60603-13
- In the desired lengths
- Individual serial number

Note:

Due to the enlarged outer contour of the molded connectors, module types with UM45 profile and three-level terminal blocks cannot be connected with the VIP-CAB-FLK... system cable.

The following module types (10- to 50-pos.) can be connected.

For example, for 20 positions:

- VIP-2/SC/FLK 20
- VIP-2/SC/FLK20/LED
- FLKM 20/ZFKDS
- UM45-FLK 20/ZFKDS (double-level connection)

The VIP-CAB-FLK... system cables are not suitable for front adapters (see the dimensional drawing).

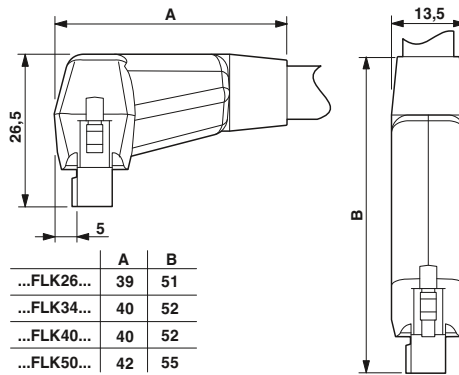

not shielded



Max. perm. operating voltage
 Max. perm. current carrying capacity per path
 Max. conductor resistance
 Ambient temperature (operation)
 Assembly

Conductor cross section
 Outside diameter

26 -position
 34 -position
 40 -position
 50 -position

< 50 V AC / 60 V DC
 1 A
 0.16 Ω/m
 -20°C ... 50°C
 Insulation displacement, IEC 60352-4/DIN EN 60352-4

AWG 26 / 0.14 mm²

8.3 mm
 8.7 mm
 9.9 mm
 10.3 mm

Technical data

Ordering data

Description	No. of pos.	Cable length	Type	Order No.	Pcs. / Pkt.
Round cable, with two molded socket strips					
	26	0.5 m	VIP-CAB-FLK26/0,14/0,5M	2318622	1
	26	1 m	VIP-CAB-FLK26/0,14/1,0M	2318635	1
	26	1.5 m	VIP-CAB-FLK26/0,14/1,5M	2318648	1
	26	2 m	VIP-CAB-FLK26/0,14/2,0M	2318651	1
	26	3 m	VIP-CAB-FLK26/0,14/3,0M	2318664	1
	26	4 m	VIP-CAB-FLK26/0,14/4,0M	2318677	1
	26	6 m	VIP-CAB-FLK26/0,14/6,0M	2318680	1
Round cable, same as before, in variable lengths (minimum ordering quantity five pieces)					
	26		VIP-CAB-FLK26-0,14/...	2318693	1
Round cable, with two molded socket strips					
	34	0.5 m	VIP-CAB-FLK34/0,14/0,5M	2318703	1
	34	1 m	VIP-CAB-FLK34/0,14/1,0M	2318716	1
	34	1.5 m	VIP-CAB-FLK34/0,14/1,5M	2318729	1
	34	2 m	VIP-CAB-FLK34/0,14/2,0M	2318732	1
	34	3 m	VIP-CAB-FLK34/0,14/3,0M	2318745	1
	34	4 m	VIP-CAB-FLK34/0,14/4,0M	2318758	1
	34	6 m	VIP-CAB-FLK34/0,14/6,0M	2318761	1
Round cable, same as before, in variable lengths (minimum ordering quantity five pieces)					
	34		VIP-CAB-FLK34-0,14/...	2318774	1
Round cable, with two molded socket strips					
	40	0.5 m	VIP-CAB-FLK40/0,14/0,5M	2318787	1
	40	1 m	VIP-CAB-FLK40/0,14/1,0M	2318790	1
	40	1.5 m	VIP-CAB-FLK40/0,14/1,5M	2318800	1
	40	2 m	VIP-CAB-FLK40/0,14/2,0M	2318813	1
	40	3 m	VIP-CAB-FLK40/0,14/3,0M	2318826	1
	40	4 m	VIP-CAB-FLK40/0,14/4,0M	2318839	1
	40	6 m	VIP-CAB-FLK40/0,14/6,0M	2318842	1
Round cable, same as before, in variable lengths (minimum ordering quantity five pieces)					
	40		VIP-CAB-FLK40-0,14/...	2318855	1
Round cable, with two molded socket strips					
	50	0.5 m	VIP-CAB-FLK50/0,14/0,5M	2318868	1
	50	1 m	VIP-CAB-FLK50/0,14/1,0M	2318871	1
	50	1.5 m	VIP-CAB-FLK50/0,14/1,5M	2318884	1
	50	2 m	VIP-CAB-FLK50/0,14/2,0M	2318897	1
	50	3 m	VIP-CAB-FLK50/0,14/3,0M	2318907	1
	50	4 m	VIP-CAB-FLK50/0,14/4,0M	2318910	1
	50	6 m	VIP-CAB-FLK50/0,14/6,0M	2318923	1
Round cable, same as before, in variable lengths (minimum ordering quantity five pieces)					
	50		VIP-CAB-FLK50-0,14/...	2318936	1

Ordering example for system cable:

– 26-pos. cable, 12.6 m long

Quantity	Order No.	Length [m]
1	2318693	12.6
		Min. 0.5 m
		Max. 100.0 m
		Step width 0.1 m

System cabling for controllers

VARIOFACE system cabling

System cable with a flat-ribbon cable plug-in connector and an open end

- 1:1 connection
- 10-, 14-, and 16-pos.
- Plug-in connectors as per IEC 60603-13
- Open end at the other end

The individual wires at the open end are labeled (1, 2, 3, 4, ...) and equipped with a ferrule.



Molded plug-in connectors, not shielded



not shielded

Notes:
In the case of molded connectors, please observe the dimensional drawing and note, see page 500



Max. perm. operating voltage	< 50 V AC / 60 V DC
Max. perm. current carrying capacity per path	1 A
Max. conductor resistance	0.16 Ω/m
Ambient temperature (operation)	-20°C ... 50°C
Assembly	Insulation displacement, IEC 60352-4/DIN EN 60352-4
Conductor cross section	AWG 26 / 0.14 mm ²
Conductor structure: stranded wires / material	7 / Cu tin-plated
Outside diameter	10 -position: 6.1 mm 14 -position: 6.4 mm 16 -position: 6.5 mm

Technical data		
Max. perm. operating voltage	< 50 V AC / 60 V DC	
Max. perm. current carrying capacity per path	1 A	
Max. conductor resistance	0.16 Ω/m	
Ambient temperature (operation)	-20°C ... 50°C	
Assembly	Insulation displacement, IEC 60352-4/DIN EN 60352-4	
Conductor cross section	AWG 26 / 0.14 mm ²	
Conductor structure: stranded wires / material	7 / Cu tin-plated	
Outside diameter	10 -position: 6.1 mm 14 -position: 6.4 mm 16 -position: 6.5 mm	

Technical data		
Max. perm. operating voltage	< 50 V AC / 60 V DC	
Max. perm. current carrying capacity per path	1 A	
Max. conductor resistance	0.16 Ω/m	
Ambient temperature (operation)	-20°C ... 50°C	
Assembly	Insulation displacement, IEC 60352-4/DIN EN 60352-4	
Conductor cross section	AWG 26 / 0.14 mm ²	
Conductor structure: stranded wires / material	7 / Cu tin-plated	
Outside diameter	6.1 mm 6.4 mm 6.5 mm	

Description	No. of pos.	Cable length
Round cable with an open end	10	0.5 m
	10	1 m
	10	1.5 m
	10	2 m
	10	2.5 m
	10	3 m
	10	4 m
	10	6 m
	10	8 m
	10	10 m
Round cable, same as before, however in variable lengths	10	
Round cable with an open end	14	0.5 m
	14	1 m
	14	1.5 m
	14	2 m
	14	2.5 m
	14	3 m
	14	4 m
	14	6 m
	14	8 m
	14	10 m
Round cable, same as before, however in variable lengths	14	
Round cable with an open end	16	0.5 m
	16	1 m
	16	1.5 m
	16	2 m
	16	2.5 m
	16	3 m
	16	4 m
	16	6 m
	16	8 m
	16	10 m
Round cable, same as before, however in variable lengths	16	

Ordering data		
Type	Order No.	Pcs. / Pkt.
VIP-CAB-FLK14/FR/OE/0,14/0,5M	2900122	1
VIP-CAB-FLK14/FR/OE/0,14/1,0M	2900123	1
VIP-CAB-FLK14/FR/OE/0,14/1,5M	2900125	1
VIP-CAB-FLK14/FR/OE/0,14/2,0M	2900126	1
VIP-CAB-FLK14/FR/OE/0,14/3,0M	2900127	1
VIP-CAB-FLK14/FR/OE/0,14/4,0M	2900128	1
VIP-CAB-FLK14/FR/OE/0,14/6,0M	2900129	1
VIP-CAB-FLK16/FR/OE/0,14/0,5M	2900130	1
VIP-CAB-FLK16/FR/OE/0,14/1,0M	2900131	1
VIP-CAB-FLK16/FR/OE/0,14/1,5M	2900132	1
VIP-CAB-FLK16/FR/OE/0,14/2,0M	2900133	1
VIP-CAB-FLK16/FR/OE/0,14/3,0M	2900134	1
VIP-CAB-FLK16/FR/OE/0,14/4,0M	2900135	1
VIP-CAB-FLK16/FR/OE/0,14/6,0M	2900136	1

Ordering data		
Type	Order No.	Pcs. / Pkt.
CABLE-FLK10/OE/0,14/ 0,5M	2904073	1
CABLE-FLK10/OE/0,14/ 1,0M	2904074	1
CABLE-FLK10/OE/0,14/ 1,5M	2904075	1
CABLE-FLK10/OE/0,14/ 2,0M	2904076	1
CABLE-FLK10/OE/0,14/ 2,5M	2904077	1
CABLE-FLK10/OE/0,14/ 3,0M	2904078	1
CABLE-FLK10/OE/0,14/ 4,0M	2904079	1
CABLE-FLK10/OE/0,14/ 6,0M	2904080	1
CABLE-FLK10/OE/0,14/ 8,0M	2904081	1
CABLE-FLK10/OE/0,14/10,0M	2904082	1
CABLE-FLK10-OE-0,14/...	2904331	1
CABLE-FLK14/OE/0,14/ 50	2305761	1
CABLE-FLK14/OE/0,14/ 100	2305253	1
CABLE-FLK14/OE/0,14/ 150	2305266	1
CABLE-FLK14/OE/0,14/ 200	2305279	1
CABLE-FLK14/OE/0,14/ 250	2305282	1
CABLE-FLK14/OE/0,14/ 300	2305295	1
CABLE-FLK14/OE/0,14/ 400	2305774	1
CABLE-FLK14/OE/0,14/ 600	2305787	1
CABLE-FLK14/OE/0,14/ 800	2305790	1
CABLE-FLK14/OE/0,14/1000	2305800	1
CABLE-FLK14/OE/0,14/...	2305732	1
CABLE-FLK16/OE/0,14/ 0,5M	2318127	1
CABLE-FLK16/OE/0,14/ 1,0M	2318130	1
CABLE-FLK16/OE/0,14/ 1,5M	2318143	1
CABLE-FLK16/OE/0,14/ 2,0M	2318156	1
CABLE-FLK16/OE/0,14/ 2,5M	2318169	1
CABLE-FLK16/OE/0,14/ 3,0M	2318172	1
CABLE-FLK16/OE/0,14/ 4,0M	2318185	1
CABLE-FLK16/OE/0,14/ 6,0M	2318198	1
CABLE-FLK16/OE/0,14/ 8,0M	2318208	1
CABLE-FLK16/OE/0,14/10,0M	2318211	1
CABLE-FLK16/OE/0,14/...	2318224	1

System cable with a flat-ribbon cable plug-in connector and an open end

- 1:1 connection
- 20- and 50-pos.
- Plug-in connectors as per IEC 60603-13
- Open end at the other end

The individual wires at the open end are labeled (1, 2, 3, 4, ...) and equipped with a ferrule.

Notes:
In the case of molded connectors, please observe the dimensional drawing and note, see page 500



Molded plug-in connectors, not shielded



not shielded

Max. perm. operating voltage
Max. perm. current carrying capacity per path
Max. conductor resistance
Ambient temperature (operation)
Assembly

< 50 V AC / 60 V DC
1 A
0.16 Ω/m
-20°C ... 50°C
Insulation displacement, IEC 60352-4/DIN EN 60352-4

Conductor cross section
Conductor structure: stranded wires / material
Outside diameter

AWG 26 / 0.14 mm²
7 / Cu tin-plated

20 -position 7.6 mm
50 -position 10.3 mm



< 50 V AC / 60 V DC
1 A
0.16 Ω/m
-20°C ... 50°C
Insulation displacement, IEC 60352-4/DIN EN 60352-4

AWG 26 / 0.14 mm²
7 / Cu tin-plated

7.6 mm
10.3 mm

Technical data

Technical data

Ordering data

Ordering data

Description	No. of pos.	Cable length
Round cable with an open end	20	0.5 m
	20	1 m
	20	1.5 m
	20	2 m
	20	2.5 m
	20	3 m
	20	4 m
	20	6 m
	20	8 m
	20	10 m
Round cable, same as before, however in variable lengths	20	
Round cable with an open end	50	0.5 m
	50	1 m
	50	1.5 m
	50	2 m
	50	2.5 m
	50	3 m
	50	4 m
	50	6 m
	50	8 m
	50	10 m
Round cable, same as before, however in variable lengths	50	

Type	Order No.	Pcs. / Pkt.
VIP-CAB-FLK20/FR/OE/0,14/0,5M	2900138	1
VIP-CAB-FLK20/FR/OE/0,14/1,0M	2900139	1
VIP-CAB-FLK20/FR/OE/0,14/1,5M	2900141	1
VIP-CAB-FLK20/FR/OE/0,14/2,0M	2900142	1
VIP-CAB-FLK20/FR/OE/0,14/3,0M	2900143	1
VIP-CAB-FLK20/FR/OE/0,14/4,0M	2900144	1
VIP-CAB-FLK20/FR/OE/0,14/6,0M	2900145	1
VIP-CAB-FLK50/FR/OE/0,14/0,5M	2900146	1
VIP-CAB-FLK50/FR/OE/0,14/1,0M	2900147	1
VIP-CAB-FLK50/FR/OE/0,14/1,5M	2900148	1
VIP-CAB-FLK50/FR/OE/0,14/2,0M	2900149	1
VIP-CAB-FLK50/FR/OE/0,14/3,0M	2900150	1
VIP-CAB-FLK50/FR/OE/0,14/4,0M	2900151	1
VIP-CAB-FLK50/FR/OE/0,14/6,0M	2900152	1

Type	Order No.	Pcs. / Pkt.
CABLE-FLK20/OE/0,14/ 50	2305826	1
CABLE-FLK20/OE/0,14/ 100	2305305	1
CABLE-FLK20/OE/0,14/ 150	2305318	1
CABLE-FLK20/OE/0,14/ 200	2305321	1
CABLE-FLK20/OE/0,14/ 250	2305334	1
CABLE-FLK20/OE/0,14/ 300	2305347	1
CABLE-FLK20/OE/0,14/ 400	2305839	1
CABLE-FLK20/OE/0,14/ 600	2305842	1
CABLE-FLK20/OE/0,14/ 800	2305855	1
CABLE-FLK20/OE/0,14/1000	2305868	1
CABLE-FLK20/OE/0,14/...	2305745	1
CABLE-FLK50/OE/0,14/ 50	2305871	1
CABLE-FLK50/OE/0,14/ 100	2305350	1
CABLE-FLK50/OE/0,14/ 150	2305363	1
CABLE-FLK50/OE/0,14/ 200	2305376	1
CABLE-FLK50/OE/0,14/ 250	2305389	1
CABLE-FLK50/OE/0,14/ 300	2305392	1
CABLE-FLK50/OE/0,14/ 400	2305884	1
CABLE-FLK50/OE/0,14/ 600	2305897	1
CABLE-FLK50/OE/0,14/ 800	2305907	1
CABLE-FLK50/OE/0,14/1000	2305910	1
CABLE-FLK50/OE/0,14/...	2305758	1

System cabling for controllers

VARIOFACE system cabling

System cable with flat-ribbon cable plug-in connector

Standard lengths

Round cable sets are used to connect the PLC front adapters to the corresponding VARIOFACE controller boards.

The following versions are available with 14 and 50 positions:

- Not shielded
- Shielded
- Halogen-free

Plug-in connector strips are fitted on both sides of the cables in accordance with IEC 60603-13/DIN 41651 (1:1 connection).

In case of shielded cables, a cable end with a ferrule is additionally provided as a shield connection (length: approx. 0.5 m; cable H05V-K 1 mm², black).

Special lengths are defined using an order key, refer to page 510.



not shielded



Technical data

Max. perm. operating voltage	< 50 V AC / 60 V DC
Max. perm. current carrying capacity per path	1 A
Max. conductor resistance	0.16 Ω/m
Ambient temperature (operation)	-20°C ... 50°C
Shield	-
Assembly	Insulation displacement, IEC 60352-4/DIN EN 60352-4
Conductor cross section	AWG 26 / 0.14 mm ²
Conductor structure: stranded wires / material	7 / Cu tin-plated
Outside diameter	14 -position: 6.4 mm 50 -position: 10.3 mm

Ordering data

Description	No. of pos.	Cable length	Type	Order No.	Pcs. / Pkt.
Assembled round cables¹⁾ , with two 14-pos. socket strips in fixed lengths, for transfer of eight channels among other things					
	14	0.3 m	FLK 14/EZ-DR/ 30/KONFEK	2295729	5
	14	0.5 m	FLK 14/EZ-DR/ 50/KONFEK	2288901	5
	14	1 m	FLK 14/EZ-DR/ 100/KONFEK	2288914	1
	14	1.5 m	FLK 14/EZ-DR/ 150/KONFEK	2288927	1
	14	2 m	FLK 14/EZ-DR/ 200/KONFEK	2288930	1
	14	2.5 m	FLK 14/EZ-DR/ 250/KONFEK	2288943	1
	14	3 m	FLK 14/EZ-DR/ 300/KONFEK	2288956	1
	14	3.5 m	FLK 14/EZ-DR/ 350/KONFEK	2288969	1
	14	4 m	FLK 14/EZ-DR/ 400/KONFEK	2288972	1
	14	4.5 m	FLK 14/EZ-DR/ 450/KONFEK	2290847	1
	14	5 m	FLK 14/EZ-DR/ 500/KONFEK	2290834	1
	14	5.5 m	FLK 14/EZ-DR/ 550/KONFEK	2290850	1
	14	6 m	FLK 14/EZ-DR/ 600/KONFEK	2290863	1
	14	7 m			
	14	8 m	FLK 14/EZ-DR/ 800/KONFEK	2299563	1
	14	10 m	FLK 14/EZ-DR/1000/KONFEK	2299576	1
Assembled round cables²⁾ , with two 50-pos. socket strips in fixed lengths, for transfer of 32 channels among other things					
	50	0.5 m	FLK 50/EZ-DR/ 50/KONFEK	2289065	5
	50	1 m	FLK 50/EZ-DR/ 100/KONFEK	2289078	1
	50	1.5 m	FLK 50/EZ-DR/ 150/KONFEK	2289081	1
	50	2 m	FLK 50/EZ-DR/ 200/KONFEK	2289094	1
	50	2.5 m	FLK 50/EZ-DR/ 250/KONFEK	2289104	1
	50	3 m	FLK 50/EZ-DR/ 300/KONFEK	2289117	1
	50	3.5 m	FLK 50/EZ-DR/ 350/KONFEK	2289120	1
	50	4 m	FLK 50/EZ-DR/ 400/KONFEK	2289133	1
	50	4.5 m	FLK 50/EZ-DR/ 450/KONFEK	2289573	1
	50	5 m	FLK 50/EZ-DR/ 500/KONFEK	2289586	1
	50	5.5 m	FLK 50/EZ-DR/ 550/KONFEK	2289599	1
	50	6 m	FLK 50/EZ-DR/ 600/KONFEK	2289609	1
	50	6.5 m	FLK 50/EZ-DR/ 650/KONFEK	2289612	1
	50	7 m	FLK 50/EZ-DR/ 700/KONFEK	2289625	1
	50	7.5 m	FLK 50/EZ-DR/ 750/KONFEK	2289638	1
	50	8 m	FLK 50/EZ-DR/ 800/KONFEK	2289641	1
	50	8.5 m	FLK 50/EZ-DR/ 850/KONFEK	2289654	1
	50	9 m	FLK 50/EZ-DR/ 900/KONFEK	2289667	1
	50	9.5 m	FLK 50/EZ-DR/ 950/KONFEK	2289670	1
	50	10 m	FLK 50/EZ-DR/1000/KONFEK	2289683	1



Shielded



Halogen-free
(only the cable)



Applied for: cUL / UL

Technical data	
< 50 V AC / 60 V DC	
1 A	
0.16 Ω/m	
-20°C ... 50°C	
Tinned copper-braided shield, approx. 85% covering	
Insulation displacement, IEC 60352-4/DIN EN 60352-4	
AWG 26 / 0.14 mm ²	
7 / Cu tin-plated	
6.7 mm	
11 mm	

Technical data	
< 50 V AC / 60 V DC	
1 A	
0.16 Ω/m	
-20°C ... 50°C	
-	
Insulation displacement, IEC 60352-4/DIN EN 60352-4	
AWG 26 / 0.14 mm ²	
7 / Cu tin-plated	
6.4 mm	
10.3 mm	

Ordering data		
Type	Order No.	Pcs. / Pkt.
FLK 14/EZ-DR/ 50/KONFEK/S	2296977	1
FLK 14/EZ-DR/ 100/KONFEK/S	2296980	1
FLK 14/EZ-DR/ 150/KONFEK/S	2296993	1
FLK 14/EZ-DR/ 200/KONFEK/S	2297002	1
FLK 14/EZ-DR/ 300/KONFEK/S	2299013	1
FLK 14/EZ-DR/ 400/KONFEK/S	2299026	1
FLK 14/EZ-DR/ 600/KONFEK/S	2299039	1
FLK 14/EZ-DR/ 800/KONFEK/S	2299042	1
FLK 14/EZ-DR/1000/KONFEK/S	2299055	1
FLK 50/EZ-DR/ 50/KONFEK/S	2299097	1
FLK 50/EZ-DR/ 100/KONFEK/S	2299107	1
FLK 50/EZ-DR/ 150/KONFEK/S	2299110	1
FLK 50/EZ-DR/ 200/KONFEK/S	2299123	1
FLK 50/EZ-DR/ 300/KONFEK/S	2299136	1
FLK 50/EZ-DR/ 400/KONFEK/S	2299149	1
FLK 50/EZ-DR/ 600/KONFEK/S	2299152	1
FLK 50/EZ-DR/ 800/KONFEK/S	2299165	1
FLK 50/EZ-DR/1000/KONFEK/S	2299178	1

Ordering data		
Type	Order No.	Pcs. / Pkt.
FLK 14/EZ-DR/HF/ 50/KONFEK	2305952	1
FLK 14/EZ-DR/HF/ 100/KONFEK	2305965	1
FLK 14/EZ-DR/HF/ 150/KONFEK	2305978	1
FLK 14/EZ-DR/HF/ 200/KONFEK	2305981	1
FLK 14/EZ-DR/HF/ 250/KONFEK	2305994	1
FLK 14/EZ-DR/HF/ 300/KONFEK	2304759	1
FLK 14/EZ-DR/HF/ 400/KONFEK	2304762	1
FLK 14/EZ-DR/HF/ 500/KONFEK	2304717	1
FLK 14/EZ-DR/HF/ 600/KONFEK	2306003	1
FLK 14/EZ-DR/HF/ 700/KONFEK	2314011	1
FLK 14/EZ-DR/HF/ 800/KONFEK	2314024	1
FLK 14/EZ-DR/HF/1000/KONFEK	2314037	1
CABLE-FLK50/0,14/HF/ 0,5M	2314134	1
CABLE-FLK50/0,14/HF/ 1,0M	2314147	1
CABLE-FLK50/0,14/HF/ 1,5M	2314150	1
CABLE-FLK50/0,14/HF/ 2,0M	2314163	1
CABLE-FLK50/0,14/HF/ 2,5M	2314176	1
CABLE-FLK50/0,14/HF/ 3,0M	2314189	1
CABLE-FLK50/0,14/HF/ 4,0M	2314192	1
CABLE-FLK50/0,14/HF/ 5,0M	2314202	1
CABLE-FLK50/0,14/HF/ 6,0M	2314215	1
CABLE-FLK50/0,14/HF/ 7,0M	2314228	1
CABLE-FLK50/0,14/HF/ 8,0M	2314231	1
CABLE-FLK50/0,14/HF/10,0M	2314244	1

Color code of system cables

No. of wires	PIN	Wire color
	1	Black
	2	Brown
	3	Red
	4	Orange
	5	Yellow
	6	Green
	7	Blue
	8	Violet
	9	Gray
10-pos.	10	White
	11	White-black
	12	White-brown
14-pos.	13	White-red
	14	White-orange
	15	White-yellow
16-pos.	16	White-green
	17	White-blue
	18	White-violet
20-pos.	19	White-gray
	20	Brown-black
	21	Brown-red
	22	Brown-orange
	23	Brown-yellow
	24	Brown-green
26-pos.	25	Brown-blue
	26	Brown-violet
	27	Brown-gray
	28	Brown-white
	29	Green-black
	30	Green-brown
	31	Green-red
	32	Green-orange
	33	Green-blue
34-pos.	34	Green-violet
	35	Green-gray
	36	Green-white
	37	Yellow-black
	38	Yellow-brown
	39	Yellow-red
40-pos.	40	Yellow-orange
	41	Yellow-blue
	42	Yellow-violet
	43	Yellow-gray
	44	Yellow-white
	45	Gray-black
	46	Gray-brown
	47	Gray-red
	48	Gray-orange
	49	Gray-yellow
50-pos.	50	Gray-green

1) Socket strips assembled straight at both ends.

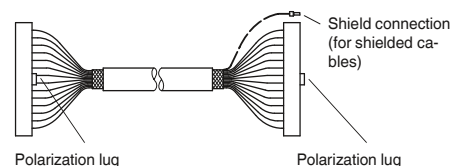

2) Socket strips assembled straight at one end and angled at the other.

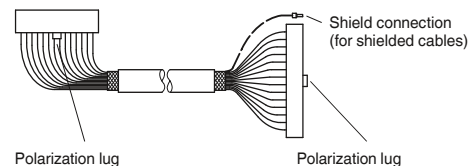

System cabling for controllers

VARIOFACE system cabling

System cable with flat-ribbon cable plug-in connector

Standard lengths

Pre-assembled round cables to couple the VARIOFACE interface modules.

Plug-in connector strips are fitted on both sides of the cables in accordance with IEC 60603-13/DIN 41651 (1:1 connection).

Special lengths are defined using an order key, refer to page 510.



not shielded

Notes:
Outside diameter of the cable
10-pos.: 6 mm
16-pos.: 6.5 mm
20-pos.: 7.6 mm
26-pos.: 7.8 mm
34-pos.: 10 mm

Max. perm. operating voltage
 Max. perm. current carrying capacity per path
 Max. conductor resistance
 Ambient temperature (operation)
 Assembly

Conductor cross section
 Conductor structure: stranded wires / material



Applied for: cUL / UL

Technical data

< 50 V AC / 60 V DC
 1 A
 0.16 Ω/m
 -20°C ... 50°C
 Insulation displacement, IEC 60352-4/DIN EN 60352-4

AWG 26 / 0.14 mm²
 7 / Cu tin-plated

Ordering data

Description	No. of pos.	Cable length	Type	Order No.	Pcs. / Pkt.
Round cable¹⁾ , with two socket strips	10	0.5 m	FLK 10/EZ-DR/ 50/KONFEK	2299204	1
	10	1 m	FLK 10/EZ-DR/ 100/KONFEK	2299217	1
	10	1.5 m	FLK 10/EZ-DR/ 150/KONFEK	2299220	1
	10	2 m	FLK 10/EZ-DR/ 200/KONFEK	2299233	1
	10	3 m	FLK 10/EZ-DR/ 300/KONFEK	2299246	1
	10	4 m	FLK 10/EZ-DR/ 400/KONFEK	2299259	1
	10	6 m	FLK 10/EZ-DR/ 600/KONFEK	2299262	1
	10	8 m	FLK 10/EZ-DR/ 800/KONFEK	2299275	1
	10	10 m	FLK 10/EZ-DR/1000/KONFEK	2299288	1
	Round cable¹⁾ , with two socket strips	16	0.5 m	FLK 16/EZ-DR/ 50/KONFEK	2299291
16		1 m	FLK 16/EZ-DR/ 100/KONFEK	2299301	1
16		1.5 m	FLK 16/EZ-DR/ 150/KONFEK	2299314	1
16		2 m	FLK 16/EZ-DR/ 200/KONFEK	2299327	1
16		3 m	FLK 16/EZ-DR/ 300/KONFEK	2299330	1
16		4 m	FLK 16/EZ-DR/ 400/KONFEK	2299343	1
16		6 m	FLK 16/EZ-DR/ 600/KONFEK	2299356	1
16		8 m	FLK 16/EZ-DR/ 800/KONFEK	2299369	1
16		10 m	FLK 16/EZ-DR/1000/KONFEK	2299372	1
Round cable¹⁾ , with two socket strips		20	0.5 m	FLK 20/EZ-DR/ 50KONFEK	2296391
	20	1 m	FLK 20/EZ-DR/ 100KONFEK	2296401	1
	20	1.5 m	FLK 20/EZ-DR/ 150KONFEK	2296472	1
	20	2 m	FLK 20/EZ-DR/ 200KONFEK	2296485	1
	20	3 m	FLK 20/EZ-DR/ 300KONFEK	2296498	1
	20	4 m	FLK 20/EZ-DR/ 400KONFEK	2296508	1
	20	6 m	FLK 20/EZ-DR/ 600KONFEK	2296511	1
	20	8 m	FLK 20/EZ-DR/ 800KONFEK	2296524	1
	20	10 m	FLK 20/EZ-DR/1000KONFEK	2296537	1
	Round cable¹⁾ , with two socket strips	26	0.5 m	FLK 26/EZ-DR/ 50/KONFEK	2299385
26		1 m	FLK 26/EZ-DR/ 100/KONFEK	2299398	1
26		1.5 m	FLK 26/EZ-DR/ 150/KONFEK	2299408	1
26		2 m	FLK 26/EZ-DR/ 200/KONFEK	2299411	1
26		3 m	FLK 26/EZ-DR/ 300/KONFEK	2299424	1
26		4 m	FLK 26/EZ-DR/ 400/KONFEK	2299437	1
26		6 m	FLK 26/EZ-DR/ 600/KONFEK	2299440	1
26		8 m	FLK 26/EZ-DR/ 800/KONFEK	2299453	1
26		10 m	FLK 26/EZ-DR/1000/KONFEK	2299466	1
Round cable¹⁾ , with two socket strips		34	0.5 m	FLK 34/EZ-DR/ 50/KONFEK	2299479
	34	1 m	FLK 34/EZ-DR/ 100/KONFEK	2299482	1
	34	1.5 m	FLK 34/EZ-DR/ 150/KONFEK	2299495	1
	34	2 m	FLK 34/EZ-DR/ 200/KONFEK	2299505	1
	34	3 m	FLK 34/EZ-DR/ 300/KONFEK	2299518	1
	34	4 m	FLK 34/EZ-DR/ 400/KONFEK	2299521	1
	34	6 m	FLK 34/EZ-DR/ 600/KONFEK	2299534	1
	34	8 m	FLK 34/EZ-DR/ 800/KONFEK	2299547	1
	34	10 m	FLK 34/EZ-DR/1000/KONFEK	2299550	1

System cable with flat-ribbon cable plug-in connector

Standard lengths

Round cable sets are used to connect the PLC front adapters to the corresponding VARIOFACE controller boards.

Plug-in connector strips are fitted on both sides of the cables in accordance with IEC 60603-13/DIN 41651 (1:1 connection).

Special lengths are defined using an order key, refer to page 510.



not shielded



Technical data

Max. perm. operating voltage	< 50 V AC / 60 V DC
Max. perm. current carrying capacity per path	1 A
Max. conductor resistance	0.16 Ω/m
Ambient temperature (operation)	-20°C ... 50°C
Assembly	Insulation displacement, IEC 60352-4/DIN EN 60352-4
Conductor cross section	AWG 26 / 0.14 mm ²
Conductor structure: stranded wires / material	7 / Cu tin-plated
Outside diameter	9.9 mm
	40 -position

Ordering data

Description	No. of pos.	Cable length	Type	Order No.	Pcs. / Pkt.
Round cable ²⁾ , with two socket strips	40	0.5 m	FLK 40/EZ-DR/ 50/KONFEK	2288985	5
	40	1 m	FLK 40/EZ-DR/ 100/KONFEK	2288998	1
	40	1.5 m	FLK 40/EZ-DR/ 150/KONFEK	2289007	1
	40	2 m	FLK 40/EZ-DR/ 200/KONFEK	2289010	1
	40	2.5 m	FLK 40/EZ-DR/ 250/KONFEK	2289023	1
	40	3 m	FLK 40/EZ-DR/ 300/KONFEK	2289036	1
	40	3.5 m	FLK 40/EZ-DR/ 350/KONFEK	2289049	1
	40	4 m	FLK 40/EZ-DR/ 400/KONFEK	2289052	1
	40	6 m	FLK 40/EZ-DR/ 600/KONFEK	2299589	1
	40	8 m	FLK 40/EZ-DR/ 800/KONFEK	2299592	1
	40	10 m	FLK 40/EZ-DR/1000/KONFEK	2299602	1

1) Socket strips assembled straight at both ends.

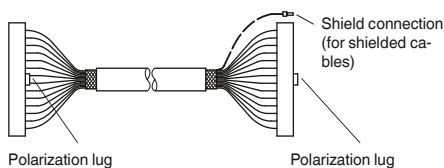

2) Socket strips assembled straight at one end and angled at the other.

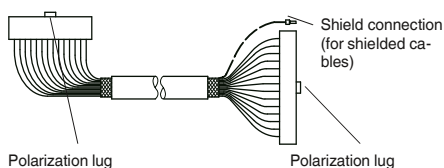

System cabling for controllers

VARIOFACE system cabling

System cable with flat-ribbon cable plug-in connector

The FLK 50... types are plugged onto the VARIOFACE front adapters for 32 channels and make it possible to split the channels into 4 x 8 channels. All 8-channel VARIOFACE modules and the PLC-V8 adapters for PLC-INTERFACE can therefore be connected.

In case of shielded cables, a cable end with a ferrule is additionally provided as a shield connection (length: approx. 0.5 m; cable H05V-K 1 mm², black).



Splitting cable unshielded
50 positions on 4 x 14



Splitting cable shielded
50 positions on 4 x 14



Max. perm. operating voltage	< 50 V AC / 60 V DC
Max. perm. current carrying capacity per path	1 A
Max. conductor resistance	0.16 Ω/m
Ambient temperature (operation)	-20°C ... 50°C
Shield	-
Assembly	Insulation displacement, IEC 60352-4/DIN EN 60352-4
Conductor cross section	AWG 26 / 0.14 mm ²
Conductor structure: stranded wires / material	7 / Cu tin-plated
Number of connectors on the module side	4
Outside diameter	6.3 mm

50 -position

Technical data		
Max. perm. operating voltage	< 50 V AC / 60 V DC	
Max. perm. current carrying capacity per path	1 A	
Max. conductor resistance	0.16 Ω/m	
Ambient temperature (operation)	-20°C ... 50°C	
Shield	-	
Assembly	Insulation displacement, IEC 60352-4/DIN EN 60352-4	
Conductor cross section	AWG 26 / 0.14 mm ²	
Conductor structure: stranded wires / material	7 / Cu tin-plated	
Number of connectors on the module side	4	
Outside diameter	6.3 mm	

Technical data		
Max. perm. operating voltage	< 50 V AC / 60 V DC	
Max. perm. current carrying capacity per path	1 A	
Max. conductor resistance	0.16 Ω/m	
Ambient temperature (operation)	-20°C ... 50°C	
Shield	Tinned copper-braided shield, approx. 85% covering	
Assembly	Insulation displacement, IEC 60352-4/DIN EN 60352-4	
Conductor cross section	AWG 26 / 0.14 mm ²	
Conductor structure: stranded wires / material	7 / Cu tin-plated	
Number of connectors on the module side	4	
Outside diameter	6.3 mm	

Description	No. of pos.	Cable length
Round cable sets , for connection to the VARIOFACE system cabling, with a 50-pos. socket strip and four 14-pos. socket strips, for splitting max. 32 channels into 4 x 8 channels.	50	0.5 m
	50	1 m
	50	1.5 m
	50	2 m
	50	2.5 m
	50	3 m
	50	4 m
	50	6 m
	50	8 m
	50	10 m
Assembled round cables , same as before, however in variable lengths	50	
Assembled round cables , same as before, however shielded and in variable lengths	50	

Ordering data		
Type	Order No.	Pcs. / Pkt.
FLK 50/4X14/EZ-DR/ 50/KONFEK	2296689	1
FLK 50/4X14/EZ-DR/ 100/KONFEK	2296692	1
FLK 50/4X14/EZ-DR/ 150/KONFEK	2296702	1
FLK 50/4X14/EZ-DR/ 200/KONFEK	2296715	1
FLK 50/4X14/EZ-DR/ 250/KONFEK	2305402	1
FLK 50/4X14/EZ-DR/ 300/KONFEK	2296728	1
FLK 50/4X14/EZ-DR/ 400/KONFEK	2296731	1
FLK 50/4X14/EZ-DR/ 600/KONFEK	2296744	1
FLK 50/4X14/EZ-DR/ 800/KONFEK	2296757	1
FLK 50/4X14/EZ-DR/1000/KONFEK	2296773	1
FLK 50-4X14-EZ-DR ...	2302405	1

Ordering data		
Type	Order No.	Pcs. / Pkt.
FLK 50-4X14-EZ-DR-S ...	2302447	1

Ordering example for system cable:

– Unshielded splitting cable 12.75 m long

Quantity	Order No.	Length [m] ¹⁾
1	2302405	12.75

¹⁾ min. 0.30 m

– Shielded splitting cable 11.00 m long

Quantity	Order No.	Length [m] ¹⁾
1	2302447	11.00

¹⁾ min. 0.30 m

System cabling for controllers

VARIOFACE system cabling

System cable with flat-ribbon cable plug-in connector

Special lengths

Pre-assembled **round cables** for connecting, e.g., PLC front adapters to the corresponding VARIOFACE termination boards. The cables are assembled with plug-in connector strips at both ends according to IEC 60603-13/DIN 41651. For shielded cables, a cable end with ferrule is available additionally as a shielded connection (length: approx. 0.5 m; cable: H05V-K 1 mm², black).

The order key for special lengths is described using three features.

The order of the features is as follows:

- Cable type
- Assembly
- Length in meters

There are two order keys, one for unshielded round cables, FLK EZ-DR/.../.../..., and one

for shielded round cables, FLK EZ-DR-S/.../.../.... To ensure clear specification when ordering, the features are described in detail below:

Cable type

- This specifies the number of individual cables within the specific cable.

Assembly

- None, the cable is not assembled at either end;
- 10-pos. socket strip at both ends, the cable is assembled with 10-pos. plug-in connectors at both ends (1:1 connection);
- 14-pos. socket strip at both ends, the cable is assembled with 14-pos. plug-in connectors at both ends

- (1:1 connection); and so on up to 50-pos. socket strip at both ends, the cable is assembled with 50-pos. plug-in connectors at both ends (1:1 connection);
- 14-pos. socket strip at one end, 16-pos. socket strip at one end, the cable is assembled with a 14-pos. plug-in connector at one end and a 16-pos. plug-in connector at the other end (for SIMATIC S7; no 1:1 connection).

Features of permissible assemblies:

Cable type \ Assembly	Unshielded round cables FLK EZ-DR/.../.../...								Shielded round cables FLK EZ-DR-S/.../.../....			
	10-pos.	14-pos.	16-pos.	20-pos.	26-pos.	34-pos.	40-pos.	50-pos.	14-pos.	16-pos.	40-pos.	50-pos.
No assembly	10U/C00/...	14U/C00/...	16U/C00/...	20U/C00/...	26U/C00/...	34U/C00/...	40U/C00/...	50U/C00/...	14S/C00/...	16S/C00/...	40S/C00/...	50S/C00/...
10-pos. socket strip at both ends	10U/C55/... ¹⁾											
14-pos. socket strip at both ends		14U/C23/... ¹⁾							14S/C23/... ¹⁾			
16-pos. socket strip at both ends			16U/C58/... ¹⁾							16S/C58/... ¹⁾		
20-pos. socket strip at both ends				20U/C61/... ¹⁾								
26-pos. socket strip at both ends					26U/C63/... ¹⁾							
34-pos. socket strip at both ends						34U/C65/... ¹⁾						
40-pos. socket strip at both ends							40U/C30/... ²⁾				40S/C30/... ²⁾	
50-pos. socket strip at both ends								50U/C38/... ²⁾				50S/C38/... ²⁾
14-pos. socket strip at one end; 16-pos. socket strip at one end		14U/C52/... ¹⁾							14S/C52/... ¹⁾			

¹⁾ Socket strips assembled straight at both ends.

²⁾ Socket strips assembled straight at one end and angled at the other.

³⁾ Socket strips assembled straight at one end and angled at the other.

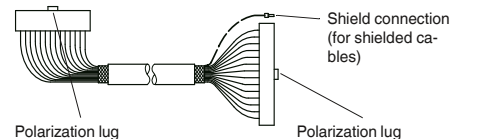
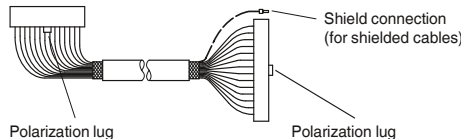
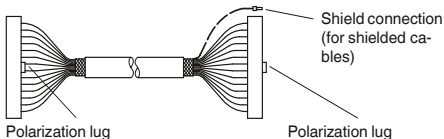

Ordering example for unshielded round cable:

- Unshielded 50-pos. round cable, assembled with two 50-pos. socket strips, 11.5 m long

Quantity	Order No.	Cable type	Assembly	Length [m] ⁴⁾
1	2295059	50U 10U ≙ 10-pos. unshielded 14U ≙ 14-pos. unshielded 16U ≙ 16-pos. unshielded 20U ≙ 20-pos. unshielded 26U ≙ 26-pos. unshielded 34U ≙ 34-pos. unshielded 40U ≙ 40-pos. unshielded 50U ≙ 50-pos. unshielded	C38 C00 ≙ No assembly C55 ≙ 10-pos. socket strip at both ends C23 ≙ 14-pos. socket strip at both ends C52 ≙ 14-pos. socket strip at one end, 16-pos. socket strip at the other (for S7) C58 ≙ 16-pos. socket strip at both ends C61 ≙ 20-pos. socket strip at both ends C63 ≙ 26-pos. socket strip at both ends C65 ≙ 34-pos. socket strip at both ends C30 ≙ 40-pos. socket strip at both ends C38 ≙ 50-pos. socket strip at both ends	11.50 ⁴⁾ Min. 0.20 m

Ordering example for shielded round cable:

- Shielded 14-pos. round cable, assembled with two 14-pos. socket strips, 12.75 m long

Quantity	Order No.	Cable type	Assembly	Length [m] ⁴⁾
1	2295046	14S 14S ≙ 14-pos. shielded 16S ≙ 16-pos. shielded 40S ≙ 40-pos. shielded 50S ≙ 50-pos. shielded	C23 C00 ≙ No assembly C23 ≙ 14-pos. socket strip at both ends C52 ≙ 14-pos. socket strip at one end, 16-pos. socket strip at the other (for S7) C58 ≙ 16-pos. socket strip at both ends C30 ≙ 40-pos. socket strip at both ends C38 ≙ 50-pos. socket strip at both ends	12.75 ⁴⁾ Min. 0.20 m



not shielded



shielded



Max. perm. operating voltage
 Max. perm. current carrying capacity per path
 Max. conductor resistance
 Ambient temperature (operation)
 Shield

Conductor cross section
 Conductor structure: stranded wires / material

Technical data

< 50 V AC / 60 V DC
 1 A
 0.16 Ω/m
 -20°C ... 50°C
 -
 AWG 26 / 0.14 mm²
 7 / Cu tin-plated

Ordering data

Description	No. of pos.	Cable length
Unshielded round cables , as above, but in variable lengths of type "FLK EZ-DR/14U/C52/..."		

Type	Order No.	Pcs. / Pkt.
FLK EZ-DR.../.../...	2295059	1

Technical data

< 50 V AC / 60 V DC
 1 A
 0.16 Ω/m
 -20°C ... 50°C
 Tinned copper-braided shield, approx. 85% covering
 AWG 26 / 0.14 mm²
 7 / Cu tin-plated

Ordering data

Type	Order No.	Pcs. / Pkt.
FLK EZ-DR-S.../.../...	2295046	1

System cabling for controllers

VARIOFACE system cabling

System cable with D-SUB socket and pin strip

Standard lengths

Shielded round cable sets to connect the control level with the corresponding VARIOFACE interface modules.

Assembly with D-SUB strips as per IEC 60807-2/DIN 41652, (1:1 connection).

- D-SUB socket strip on one side and D-SUB pin strip on the other
- D-SUB sockets on both sides
- D-SUB pin strips on both sides
- Cable exit: straight
- Screw connection: 2 UNC 4-40 screws.

Special lengths and assembly versions are defined using an order key, refer to page 514.



Socket at one end and pin strip at the other



Technical data

Max. perm. operating voltage	125 V AC/DC	
Max. perm. current carrying capacity per path	2 A	
Max. conductor resistance	0.09 Ω/m	
Ambient temperature (operation)	-20°C ... 50°C	
Shield	Tinned copper-braided shield, approx. 85% covering	
Insertion/withdrawal cycles	> 200	
Conductor cross section	AWG 24 / 0.25 mm ²	
Outside diameter		
	9 -position	7.5 mm
	15 -position	9 mm
	25 -position	10.5 mm
	37 -position	12.5 mm
	50 -position	13.5 mm

Ordering data

Description	No. of pos.	Cable length	Type	Order No.	Pcs. / Pkt.
Shielded round cable , fitted with two D-SUB strips, various numbers of positions and lengths					
	9	0.5 m	CABLE-D 9SUB/B/S/ 50/KONFEK/S	2299987	1
	9	1 m	CABLE-D 9SUB/B/S/100/KONFEK/S	2299990	1
	9	1.5 m	CABLE-D 9SUB/B/S/150/KONFEK/S	2300009	1
	9	2 m	CABLE-D 9SUB/B/S/200/KONFEK/S	2302010	1
	9	3 m	CABLE-D 9SUB/B/S/300/KONFEK/S	2302023	1
	9	4 m	CABLE-D 9SUB/B/S/400/KONFEK/S	2302036	1
	9	6 m	CABLE-D 9SUB/B/S/600/KONFEK/S	2302049	1
	15	0.5 m	CABLE-D15SUB/B/S/ 50/KONFEK/S	2302052	1
	15	1 m	CABLE-D15SUB/B/S/100/KONFEK/S	2302065	1
	15	1.5 m	CABLE-D15SUB/B/S/150/KONFEK/S	2302078	1
	15	2 m	CABLE-D15SUB/B/S/200/KONFEK/S	2302081	1
	15	3 m	CABLE-D15SUB/B/S/300/KONFEK/S	2302094	1
	15	4 m	CABLE-D15SUB/B/S/400/KONFEK/S	2302104	1
	15	6 m	CABLE-D15SUB/B/S/600/KONFEK/S	2302117	1
	25	0.5 m	CABLE-D25SUB/B/S/ 50/KONFEK/S	2302120	1
	25	1 m	CABLE-D25SUB/B/S/100/KONFEK/S	2302133	1
	25	1.5 m	CABLE-D25SUB/B/S/150/KONFEK/S	2302146	1
	25	2 m	CABLE-D25SUB/B/S/200/KONFEK/S	2302159	1
	25	3 m	CABLE-D25SUB/B/S/300/KONFEK/S	2302162	1
	25	4 m	CABLE-D25SUB/B/S/400/KONFEK/S	2302175	1
	25	6 m	CABLE-D25SUB/B/S/600/KONFEK/S	2302188	1
	37	0.5 m	CABLE-D37SUB/B/S/ 50/KONFEK/S	2302191	1
	37	1 m	CABLE-D37SUB/B/S/100/KONFEK/S	2302201	1
	37	1.5 m	CABLE-D37SUB/B/S/150/KONFEK/S	2302214	1
	37	2 m	CABLE-D37SUB/B/S/200/KONFEK/S	2302227	1
	37	3 m	CABLE-D37SUB/B/S/300/KONFEK/S	2302230	1
	37	4 m	CABLE-D37SUB/B/S/400/KONFEK/S	2302243	1
	37	6 m	CABLE-D37SUB/B/S/600/KONFEK/S	2302256	1
	37	8 m			
	37	10 m			
	37	15 m			
	37	20 m			
	50	0.5 m	CABLE-D50SUB/B/S/ 50/KONFEK/S	2302269	1
	50	1 m	CABLE-D50SUB/B/S/100/KONFEK/S	2302272	1
	50	1.5 m	CABLE-D50SUB/B/S/150/KONFEK/S	2302285	1
	50	2 m	CABLE-D50SUB/B/S/200/KONFEK/S	2302298	1
	50	3 m	CABLE-D50SUB/B/S/300/KONFEK/S	2302308	1
	50	4 m	CABLE-D50SUB/B/S/400/KONFEK/S	2302311	1
	50	6 m	CABLE-D50SUB/B/S/600/KONFEK/S	2302324	1

Color code of the system cables
CABLE-D...SUB/...



Socket strip at both ends



Pin strip at both ends



Technical data

125 V AC/DC
2 A
0.09 Ω/m
-20°C ... 50°C
Tinned copper-braided shield, approx. 85% covering

> 200
AWG 24 / 0.25 mm²

7.5 mm
9 mm
10.5 mm
12 mm
13.5 mm

Ordering data



Technical data

125 V AC/DC
2 A
0.09 Ω/m
-20°C ... 50°C
Tinned copper-braided shield, approx. 85% covering

> 200
AWG 24 / 0.25 mm²

7.5 mm
9 mm
10.5 mm
12 mm
13.5 mm

Ordering data

No. of wires	PIN	Wire color
	1	white
	2	brown
	3	green
	4	yellow
	5	gray
	6	pink
	7	blue
	8	red
9-pos.	9	black
	10	violet
	11	gray-pink
	12	red-blue
	13	white-green
	14	brown-green
15-pos.	15	white-yellow
	16	yellow-brown
	17	white-gray
	18	gray-brown
	19	white-pink
	20	pink-brown
	21	white-blue
	22	brown-blue
	23	white-red
	24	brown-red
25-pos.	25	white-black
	26	brown-black
	27	gray-green
	28	yellow-gray
	29	pink-green
	30	yellow-pink
	31	green-blue
	32	yellow-blue
	33	green-red
	34	yellow-red
	35	green-black
	36	yellow-black
37-pos.	37	gray-blue
	38	pink-blue
	39	gray-red
	40	pink-red
	41	gray-black
	42	pink-black
	43	blue-black
	44	red-black
	45	white-brown-black
	46	yellow-green-black
	47	gray-pink-black
	48	blue-red-black
	49	white-green-black
50-pos.	50	green-brown-black

Type	Order No.	Pcs. / Pkt.	Type	Order No.	Pcs. / Pkt.
CABLE-D 9SUB/B/B/100/KONFEK/S	2305415	1	CABLE-D 9SUB/S/S/100/KONFEK/S	2305570	1
CABLE-D 9SUB/B/B/200/KONFEK/S	2305428	1	CABLE-D 9SUB/S/S/200/KONFEK/S	2305583	1
CABLE-D 9SUB/B/B/300/KONFEK/S	2305431	1	CABLE-D 9SUB/S/S/300/KONFEK/S	2305596	1
CABLE-D15SUB/B/B/100/KONFEK/S	2305444	1	CABLE-D15SUB/S/S/100/KONFEK/S	2305606	1
CABLE-D15SUB/B/B/200/KONFEK/S	2305457	1	CABLE-D15SUB/S/S/200/KONFEK/S	2305619	1
CABLE-D15SUB/B/B/300/KONFEK/S	2305460	1	CABLE-D15SUB/S/S/300/KONFEK/S	2305622	1
CABLE-D25SUB/B/B/100/KONFEK/S	2305473	1	CABLE-D25SUB/S/S/100/KONFEK/S	2305635	1
CABLE-D25SUB/B/B/200/KONFEK/S	2305486	1	CABLE-D25SUB/S/S/200/KONFEK/S	2305648	1
CABLE-D25SUB/B/B/300/KONFEK/S	2305499	1	CABLE-D25SUB/S/S/300/KONFEK/S	2305651	1
CABLE-D37SUB/B/B/ 100/KONFEK/S	2305509	1	CABLE-D37SUB/S/S/100/KONFEK/S	2305664	1
CABLE-D37SUB/B/B/ 200/KONFEK/S	2305512	1	CABLE-D37SUB/S/S/200/KONFEK/S	2305677	1
CABLE-D37SUB/B/B/ 300/KONFEK/S	2305525	1	CABLE-D37SUB/S/S/300/KONFEK/S	2305680	1
CABLE-D37SUB/B/B/ 400/KONFEK/S	2900759	1			
CABLE-D37SUB/B/B/ 600/KONFEK/S	2900760	1			
CABLE-D37SUB/B/B/ 800/KONFEK/S	2900761	1			
CABLE-D37SUB/B/B/1000/KONFEK/S	2900762	1			
CABLE-D37SUB/B/B/1500/KONFEK/S	2900763	1			
CABLE-D37SUB/B/B/2000/KONFEK/S	2900764	1			
CABLE-D50SUB/B/B/100/KONFEK/S	2305541	1	CABLE-D50SUB/S/S/100/KONFEK/S	2305693	1
CABLE-D50SUB/B/B/200/KONFEK/S	2305554	1	CABLE-D50SUB/S/S/200/KONFEK/S	2305703	1
CABLE-D50SUB/B/B/300/KONFEK/S	2305567	1	CABLE-D50SUB/S/S/300/KONFEK/S	2305716	1

System cabling for controllers

VARIOFACE system cabling

System cable with D-SUB sockets and pin strip

Special lengths

Pre-assembled shielded **round cables** for connecting VARIOFACE termination boards. The cables are assembled with D-SUB strips in accordance with IEC 60807-2/DIN 41652.

The order key is defined by three features.

The features in the appropriate sequence are:

- Cable type
- Assembly
- Length in meters

There are three assembly variants of the shielded round cable:

- CABLE D-SUB-S/.../.../... D-SUB socket strip on one end and D-SUB pin strip on the other
- CABLE D-SUB-B-B-S/.../.../... D-SUB

socket strip at both ends
 - CABLE D-SUB-S-S/.../.../... D-SUB pin strip at both ends
 The features necessary for clear identification of an order are described below:

Cable type

- The number of individual cables within the cable is defined here.

Assembly

- (example for CABLE D-SUB-S/.../.../...)
- None, the cable is not assembled at either end
- 9-pos. D-SUB socket strip at one end 9-pos. D-SUB pin strip at one end the cable connects (1:1) a 9-pos. D-SUB socket and pin strip

- 15-pos. D-SUB socket strip at one end 15-pos. D-SUB pin strip at one end the cable connects (1:1) a 15-pos. D-SUB socket and pin strip; or up to
- 50-pos. D-SUB socket strip at one end 50-pos. D-SUB pin strip at one end the cable connects (1:1) a 50-pos. D-SUB socket and pin strip.

Sample order for round cable set assembled with pin strip on one side and socket strip on one side

- unshielded 25-pos. round cable set, assembled with one 25-pos. D-SUB socket strip and one 25-pos. D-SUB pin strip, 11.5 mm long

Quantity	Order No.	Cable type	Assembly	Length [m] ¹⁾
1	2302340	25S 09S ≙ 9-pos. shielded 15S ≙ 15-pos. shielded 25S ≙ 25-pos. shielded 37S ≙ 37-pos. shielded 50S ≙ 50-pos. shielded	C36 C00 ≙ no assembly C01 ≙ 9-pos. D-SUB socket strip at one end 9-pos. D-SUB pin strip at one end C28 ≙ 15-pos. D-SUB socket strip at one end 15-pos. D-SUB pin strip at one end C36 ≙ 25-pos. D-SUB socket strip at one end 25-pos. D-SUB pin strip at one end C43 ≙ 37-pos. D-SUB socket strip at one end 37-pos. D-SUB pin strip at one end C49 ≙ 50-pos. D-SUB socket strip at one end 50-pos. D-SUB pin strip at one end	11.50 ¹⁾ min. 0.20 m

Sample order for round cable set assembled with socket strip at both ends

- Shielded 37-pos. round cable, assembled with two 37-pos. D-SUB socket strips, 12.75 m long

Quantity	Order No.	Cable type	Assembly	Length [m] ¹⁾
1	2302421	37S 09S ≙ 9-pos. shielded 15S ≙ 15-pos. shielded 25S ≙ 25-pos. shielded 37S ≙ 37-pos. shielded 50S ≙ 50-pos. shielded	C44 C00 ≙ no assembly C22 ≙ 9-pos. D-SUB socket strip at both ends C29 ≙ 15-pos. D-SUB socket strip at both ends C37 ≙ 25-pos. D-SUB socket strip at both ends C44 ≙ 37-pos. D-SUB socket strip at both ends C50 ≙ 50-pos. D-SUB socket strip at both ends	12.75 ¹⁾ min. 0.20 m

Sample order for round cable set assembled with pin strip at both ends

- Shielded 15-pos. round cable, assembled with two 15-pos. D-SUB pin strips, 8.5 m long

Quantity	Order No.	Cable type	Assembly	Length [m] ¹⁾
1	2302434	15S 09S ≙ 9-pos. shielded 15S ≙ 15-pos. shielded 25S ≙ 25-pos. shielded 37S ≙ 37-pos. shielded 50S ≙ 50-pos. shielded	C71 C00 ≙ no assembly C70 ≙ 9-pos. D-SUB pin strip at both ends C71 ≙ 15-pos. D-SUB pin strip at both ends C72 ≙ 25-pos. D-SUB pin strip at both ends C73 ≙ 37-pos. D-SUB pin strip at both ends C74 ≙ 50-pos. D-SUB pin strip at both ends	8.50 ¹⁾ min. 0.20 m



Shielded



Technical data

Max. perm. operating voltage	125 V AC/DC
Max. perm. current carrying capacity per path	2 A
Max. conductor resistance	0.09 Ω/m
Ambient temperature (operation)	-20°C ... 50°C
Shield	Tinned copper-braided shield, approx. 85% covering
Insertion/withdrawal cycles	> 200
Conductor cross section	AWG 24 / 0.25 mm ²

Ordering data

Description	No. of pos.	Cable length	Type	Order No.	Pcs. / Pkt.
Assembled round cables, in variable lengths, pin strip on one side and socket strip on one side			CABLE D-SUB-S/.../.../...	2302340	1
Assembled round cables, in variable lengths, socket strip on both sides			CABLE D-SUB-B-B-S/.../.../...	2302421	1
Assembled round cables, in variable lengths, pin strip on both sides			CABLE D-SUB-S-S-S/.../.../...	2302434	1

System cabling for controllers

VARIOFACE system cabling

System cable with D-SUB socket or pin strip and one open end

- 1:1 connection
- D-SUB socket or pin strip at one end
- Connector according to IEC 60807-2/DIN 41652
- Gland: 2 UNC 4-40 screws
- Open end at the other end
- Individual wire marking: 1, 2, 3, 4, etc.
- Individual wires fitted with ferrules
- Shield connection: H05V-K 1 mm² cable, black, 0.5 m in length



Socket strip at one end and open end at the other end



Pin strip at one end and open end at the other end

			Technical data			Technical data		
Max. perm. operating voltage			125 V AC/DC			125 V AC/DC		
Max. perm. current carrying capacity per path			2 A			2 A		
Max. conductor resistance			0.09 Ω/m			0.09 Ω/m		
Ambient temperature (operation)			-20°C ... 50°C			-20°C ... 50°C		
Shield			Tinned copper-braided shield, approx. 85% covering			Tinned copper-braided shield, approx. 85% covering		
Insertion/withdrawal cycles			> 200			> 200		
Conductor cross section			AWG 24 / 0.25 mm ²			AWG 24 / 0.25 mm ²		
Outside diameter								
	9 -position	7.5 mm				7.5 mm		
	15 -position	9 mm				9 mm		
	25 -position	10.5 mm				10.5 mm		
			Ordering data			Ordering data		
Description	No. of pos.	Cable length	Type	Order No.	Pcs. / Pkt.	Type	Order No.	Pcs. / Pkt.
Round cable with an open end	9	0.5 m	CABLE-D-9SUB/F/OE/0,25/S/0,5M	2926014	1	CABLE-D-9SUB/M/OE/0,25/S/0,5M	2926360	1
	9	1 m	CABLE-D-9SUB/F/OE/0,25/S/1,0M	2926027	1	CABLE-D-9SUB/M/OE/0,25/S/1,0M	2926373	1
	9	1.5 m	CABLE-D-9SUB/F/OE/0,25/S/1,5M	2926030	1	CABLE-D-9SUB/M/OE/0,25/S/1,5M	2926386	1
	9	2 m	CABLE-D-9SUB/F/OE/0,25/S/2,0M	2926043	1	CABLE-D-9SUB/M/OE/0,25/S/2,0M	2926399	1
	9	3 m	CABLE-D-9SUB/F/OE/0,25/S/3,0M	2926056	1	CABLE-D-9SUB/M/OE/0,25/S/3,0M	2926409	1
	9	4 m	CABLE-D-9SUB/F/OE/0,25/S/4,0M	2926069	1	CABLE-D-9SUB/M/OE/0,25/S/4,0M	2926412	1
	9	6 m	CABLE-D-9SUB/F/OE/0,25/S/6,0M	2926072	1	CABLE-D-9SUB/M/OE/0,25/S/6,0M	2926425	1
Round cable, same as before, however in variable lengths	9		CABLE-D-9SUB-F-OE-0,25-S/...	2900903	1	CABLE-D-9SUB-M-OE-0,25-S/...	2900909	1
Round cable with an open end	15	0.5 m	CABLE-D-15SUB/F/OE/0,25/S/0,5M	2926085	1	CABLE-D-15SUB/M/OE/0,25/S/0,5M	2926438	1
	15	1 m	CABLE-D-15SUB/F/OE/0,25/S/1,0M	2926098	1	CABLE-D-15SUB/M/OE/0,25/S/1,0M	2926441	1
	15	1.5 m	CABLE-D-15SUB/F/OE/0,25/S/1,5M	2926108	1	CABLE-D-15SUB/M/OE/0,25/S/1,5M	2926454	1
	15	2 m	CABLE-D-15SUB/F/OE/0,25/S/2,0M	2926111	1	CABLE-D-15SUB/M/OE/0,25/S/2,0M	2926467	1
	15	3 m	CABLE-D-15SUB/F/OE/0,25/S/3,0M	2926124	1	CABLE-D-15SUB/M/OE/0,25/S/3,0M	2926470	1
	15	4 m	CABLE-D-15SUB/F/OE/0,25/S/4,0M	2926137	1	CABLE-D-15SUB/M/OE/0,25/S/4,0M	2926483	1
	15	6 m	CABLE-D-15SUB/F/OE/0,25/S/6,0M	2926140	1	CABLE-D-15SUB/M/OE/0,25/S/6,0M	2926496	1
Round cable, same as before, however in variable lengths	15		CABLE-D-15SUB-F-OE-0,25-S/...	2900905	1	CABLE-D-15SUB-M-OE-0,25-S/...	2900910	1
Round cable with an open end	25	0.5 m	CABLE-D-25SUB/F/OE/0,25/S/0,5M	2926153	1	CABLE-D-25SUB/M/OE/0,25/S/0,5M	2926506	1
	25	1 m	CABLE-D-25SUB/F/OE/0,25/S/1,0M	2926166	1	CABLE-D-25SUB/M/OE/0,25/S/1,0M	2926519	1
	25	1.5 m	CABLE-D-25SUB/F/OE/0,25/S/1,5M	2926179	1	CABLE-D-25SUB/M/OE/0,25/S/1,5M	2926522	1
	25	2 m	CABLE-D-25SUB/F/OE/0,25/S/2,0M	2926182	1	CABLE-D-25SUB/M/OE/0,25/S/2,0M	2926535	1
	25	3 m	CABLE-D-25SUB/F/OE/0,25/S/3,0M	2926195	1	CABLE-D-25SUB/M/OE/0,25/S/3,0M	2926548	1
	25	4 m	CABLE-D-25SUB/F/OE/0,25/S/4,0M	2926205	1	CABLE-D-25SUB/M/OE/0,25/S/4,0M	2926551	1
	25	6 m	CABLE-D-25SUB/F/OE/0,25/S/6,0M	2926218	1	CABLE-D-25SUB/M/OE/0,25/S/6,0M	2926564	1
Round cable, same as before, however in variable lengths	25		CABLE-D-25SUB-F-OE-0,25-S/...	2900906	1	CABLE-D-25SUB-M-OE-0,25-S/...	2900911	1

Special lengths of D-SUB cable with open ends can be configured using separate order numbers.

Ordering example:

One system cable assembled with a 37-pos. D-SUB socket strip and one open end, 12.75 m in length:

1 pcs. 2900907/12,75



Socket strip at one end and open end at the other end



Pin strip at one end and open end at the other end

			Technical data			Technical data		
Max. perm. operating voltage			125 V AC/DC			125 V AC/DC		
Max. perm. current carrying capacity per path			2 A			2 A		
Max. conductor resistance			0.09 Ω/m			0.09 Ω/m		
Ambient temperature (operation)			-20°C ... 50°C			-20°C ... 50°C		
Shield			Tinned copper-braided shield, approx. 85% covering			Tinned copper-braided shield, approx. 85% covering		
Insertion/withdrawal cycles			> 200			> 200		
Conductor cross section			AWG 24 / 0.25 mm ²			AWG 24 / 0.25 mm ²		
Outside diameter	37 -position	12 mm				12 mm		
	50 -position	13.5 mm				13.5 mm		
			Ordering data			Ordering data		
Description	No. of pos.	Cable length	Type	Order No.	Pcs. / Pkt.	Type	Order No.	Pcs. / Pkt.
Round cable with an open end	37	0.5 m	CABLE-D-37SUB/F/OE/0,25/S/0,5M	2926221	1	CABLE-D-37SUB/M/OE/0,25/S/0,5M	2926577	1
	37	1 m	CABLE-D-37SUB/F/OE/0,25/S/1,0M	2926234	1	CABLE-D-37SUB/M/OE/0,25/S/1,0M	2926580	1
	37	1.5 m	CABLE-D-37SUB/F/OE/0,25/S/1,5M	2926247	1	CABLE-D-37SUB/M/OE/0,25/S/1,5M	2926593	1
	37	2 m	CABLE-D-37SUB/F/OE/0,25/S/2,0M	2926250	1	CABLE-D-37SUB/M/OE/0,25/S/2,0M	2926603	1
	37	3 m	CABLE-D-37SUB/F/OE/0,25/S/3,0M	2926263	1	CABLE-D-37SUB/M/OE/0,25/S/3,0M	2926616	1
	37	4 m	CABLE-D-37SUB/F/OE/0,25/S/4,0M	2926276	1	CABLE-D-37SUB/M/OE/0,25/S/4,0M	2926629	1
	37	6 m	CABLE-D-37SUB/F/OE/0,25/S/6,0M	2926289	1	CABLE-D-37SUB/M/OE/0,25/S/6,0M	2926632	1
Round cable, same as before, however in variable lengths	37		CABLE-D-37SUB-F-OE-0,25-S/...	2900907	1	CABLE-D-37SUB-M-OE-0,25-S/...	2900912	1
Round cable with an open end	50	0.5 m	CABLE-D-50SUB/F/OE/0,25/S/0,5M	2926292	1	CABLE-D-50SUB/M/OE/0,25/S/0,5M	2926645	1
	50	1 m	CABLE-D-50SUB/F/OE/0,25/S/1,0M	2926302	1	CABLE-D-50SUB/M/OE/0,25/S/1,0M	2926658	1
	50	1.5 m	CABLE-D-50SUB/F/OE/0,25/S/1,5M	2926315	1	CABLE-D-50SUB/M/OE/0,25/S/1,5M	2926661	1
	50	2 m	CABLE-D-50SUB/F/OE/0,25/S/2,0M	2926328	1	CABLE-D-50SUB/M/OE/0,25/S/2,0M	2926674	1
	50	3 m	CABLE-D-50SUB/F/OE/0,25/S/3,0M	2926331	1	CABLE-D-50SUB/M/OE/0,25/S/3,0M	2926687	1
	50	4 m	CABLE-D-50SUB/F/OE/0,25/S/4,0M	2926344	1	CABLE-D-50SUB/M/OE/0,25/S/4,0M	2926690	1
	50	6 m	CABLE-D-50SUB/F/OE/0,25/S/6,0M	2926357	1	CABLE-D-50SUB/M/OE/0,25/S/6,0M	2926700	1
Round cable, same as before, however in variable lengths	50		CABLE-D-50SUB-F-OE-0,25-S/...	2900908	1	CABLE-D-50SUB-M-OE-0,25-S/...	2900913	1

System cable with a 56-pos. ELCO/EDAC plug-in connector and an open end

Assembled system cable for connecting 56-pos. EDAC plug-in connectors from the 516 series or ELCO plug-in connectors from the 8016 series.

- Single-sided 516 series EDAC socket plug-in connectors
- Metal housing with lateral cable outlet
- Coding sockets in location 1 by default
- Open end at the other end
- Single wire marking:
1, 2, 3, ... 53, 54, Y, Z (see pin assignment)
- Shield connection on both sides:
H05V-K 1 mm² cable, black, length: 0.5 m

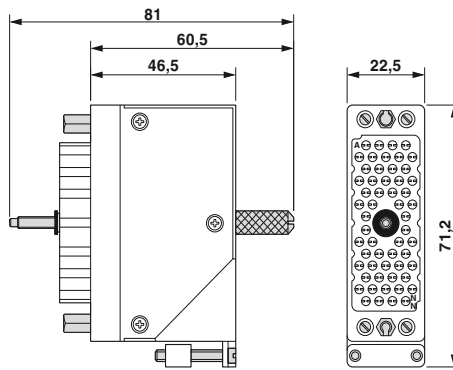

56-pos. system cable

Notes:
The system cables are designed specifically for the UMK-EC56/56-XOR (2975900) and UMK-EC56/56-XOL (2975890) modules.
When using the UMK-EC56/FRONT 2,5V/R (2976161) or UMK-EC56/FRONT 2,5V/L (2976158) modules, the coding sockets must be adapted accordingly.
Observe the module and system cable layouts.

Max. perm. operating voltage
Max. perm. current carrying capacity per path
Max. conductor resistance
Ambient temperature (operation)
Shield

Technical data

25 V AC / 60 V DC
1.5 A
0.056 Ω/m
-20°C ... 60°C
Tinned copper-braided shield, approx. 85% covering

Conductor cross section
Conductor structure: stranded wires / material

AWG 22 / 0.34 mm²
19 / Cu uninsulated

Ordering data

Description	No. of pos.	Cable length
Shielded round cable , single-sided with assembled EDAC socket plug-in connector and an open end		
	56	1 m
	56	2 m
	56	4 m
	56	6 m
	56	8 m
	56	10 m
	56	15 m
	56	20 m

Shielded round cable, as above, but in variable lengths

Type	Order No.	Pcs. / Pkt.
CABLE-EC56/F/OE/0,34/S/ 1,0M	2903395	1
CABLE-EC56/F/OE/0,34/S/ 2,0M	2903396	1
CABLE-EC56/F/OE/0,34/S/ 4,0M	2903397	1
CABLE-EC56/F/OE/0,34/S/ 6,0M	2903398	1
CABLE-EC56/F/OE/0,34/S/ 8,0M	2903399	1
CABLE-EC56/F/OE/0,34/S/10,0M	2903400	1
CABLE-EC56/F/OE/0,34/S/15,0M	2903401	1
CABLE-EC56/F/OE/0,34/S/20,0M	2903402	1
CABLE-EC56-F-OE-0,34-S/...	2904025	1

Pin assignment

Single wire marking	EDAC socket plug-in connector	Single wire marking	EDAC socket plug-in connector
Z	Z	31	m
1	A	32	n
2	B	33	p
3	C	34	r
4	D	35	s
5	E	36	t
6	F	37	u
7	H	38	v
8	J	39	w
9	K	40	x
10	L	41	y
11	M	42	z
12	N	43	AA
13	P	44	BB
14	R	45	CC
15	S	46	DD
16	T	47	EE
17	U	48	FF
18	V	49	HH
19	W	50	JJ
20	X	51	KK
21	a	52	LL
22	b	53	MM
23	c	54	NN
24	d	Y	Y
25	e		
26	f		
27	h		
28	j		
29	k		
30	l		

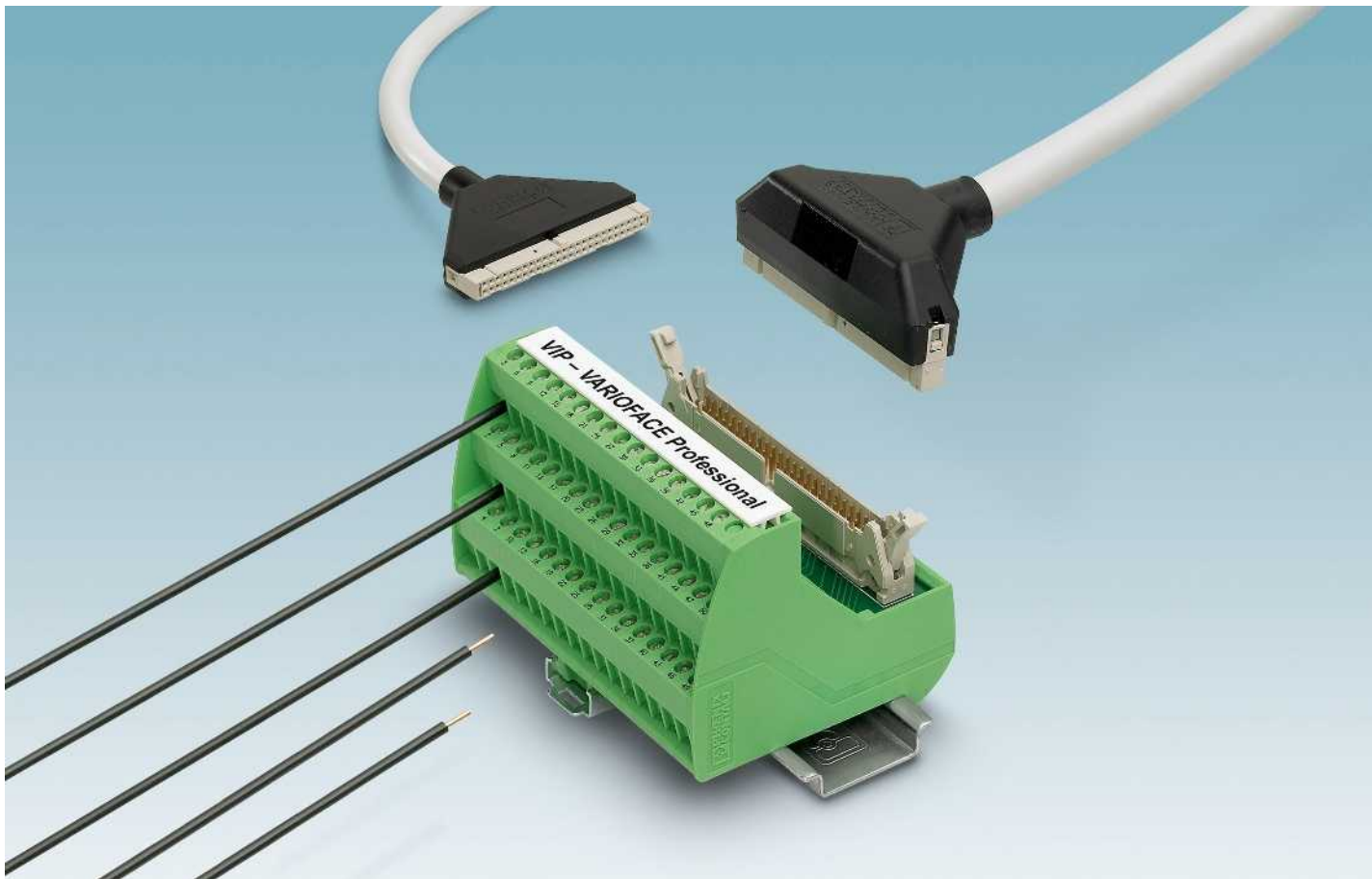

VIP – VARIOFACE Professional – secure and reliable connections in even the tightest of spaces

Space is extremely valuable in the control cabinet. That is why the I/O of automation devices feature high-position plug-in connectors. To enable the individual wires of the sensor/actuator level to be connected to the automation interface in accordance with industry requirements, Phoenix Contact is now able to offer new interface modules and new system cables inside a professional and compact housing design. Thanks to the encapsulated system cables, the control and process levels can be connected safely and reliably in harsh industrial environments.

To allow all components to be supplied with power, potential distributors are available with the same housing design.

VARIOFACE Professional means:

New modules:

- Space-saving
- Vibration resistant thanks to metal foot
- Optional marking
- New housing design

New FLK system cables:

- Encapsulated FLK plug-in connectors
- Professional strain relief
- Robust design

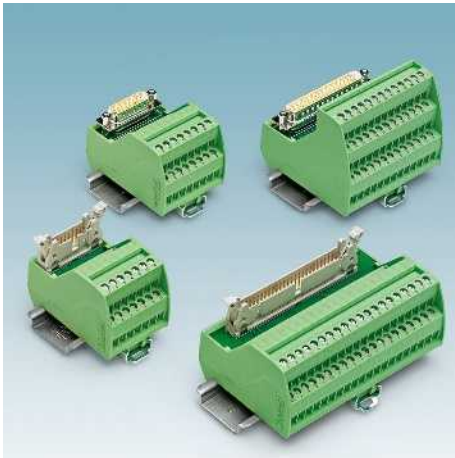

VIP - VARIOFACE Professional interface modules

Interface modules with various connection technologies and designs are available for the widely-used FLK, D-SUB, and high-density D-SUB plug-in connectors. Modules with a status indicator can be selected for operation monitoring purposes.



Interface module with ELCO or DIN plug-in connector

Modules with ELCO plug-in connectors exist for robust environments or where there are increased safety requirements.

Interface modules are also available for DIN strip types C, D, E, and F.

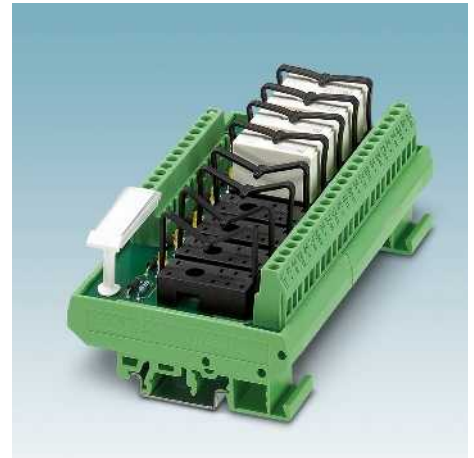

Relay/solid-state relay modules

The active modules are configured as a 4-channel, 8-channel, and 16-channel interface. Multi-channel modules exist for relay and signal/power optocouplers. These allow functions such as signal conditioning, electrical isolation, and power gain to be achieved.



System cables with encapsulated FLK or D-SUB plug-in connectors

Assembled FLK and D-SUB cables guarantee a reliable connection between the automation device and the module. 1 A (FLK cable) and 2 A (D-SUB cable) currents can be transmitted on each signal path thanks to the large conductor cross sections.

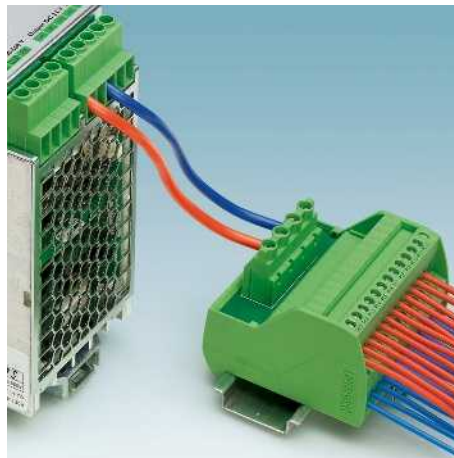

VIP - VARIOFACE Professional potential distributors

Designed for up to 250 V/30 V, the potential distributors can be used universally – for both operating voltage and control voltage distribution. Screw connections or spring-cage connection can be selected as required for the application.

System cabling for controllers

VARIOFACE wiring interface

Product overview for VIP - VARIOFACE Professional

Device series	Passive modules (connection technology)				
	Flat-ribbon cable strip	D-SUB strip	DIN strip	ELCO strip	Potential distributor
VIP Line	 Page 524	 Page 532 539	 Page 540	 Page 544	 Page 548
Standard Line			 540	 544	
Slim Line	 528	 536			
Feed-through modules	 530	 537			
Cables	 500	 512			

COMBICON



Page

Device series

Active modules (function)

**Relays/
solid-state relays**



Page

Solid-state relays



Page

Standard Line



550

553

Accessories



554

558

547

547

VARIOFACE wiring interface

VIP – VARIOFACE Professional Modules with flat-ribbon cable plug-in connectors

- 1:1 connection
 - 10- to 64-pos.
 - Screw connection
 - Metal foot
 - As per IEC 60603-13
 - Optional with status indicator
- Low and high engagement latches are supplied with all modules.

Notes:

For marking systems (e.g., "ZB 22:UNBEDRUCKT"; Order No. 0811862) and mounting material, see Catalog 5.



10 to 20 positions with screw connection



Technical data

Operating voltage	60 V AC/DC
Max. perm. current (per branch)	1 A
Ambient temperature (operation)	-20°C ... 50°C
Mounting position	Any
Standards/regulations	IEC 60664, DIN EN 50178, IEC 62103
Connection data solid / stranded / AWG	0.2 - 4 mm ² / 0.2 - 2.5 mm ² / 24 - 12
Dimensions	H / D 65.5 mm / 56 mm

Ordering data

Description	No. of pos.	Module width W	Type	Order No.	Pcs. / Pkt.
VARIOFACE module, with pin strip	10	34.70	VIP-2/SC/FLK10	2315010	1
	14	39.80	VIP-2/SC/FLK14	2315023	1
	16	45.00	VIP-2/SC/FLK16	2315036	1
	20	55.10	VIP-2/SC/FLK20	2315049	1
VARIOFACE module, with pin strip and light indicator	10	34.70			
	14	44.90			
	16	50.00			
	20	60.20			
VARIOFACE module, with pin strip	26	57.10			
	34	67.30			
	40	77.40			
	50	92.70			
	60	108.00			
	64	118.00			
VARIOFACE module, with pin strip and light indicator	26	57.40			
	34	67.60			
	40	77.80			
	50	93.10			
	60	113.50			
	64	118.60			

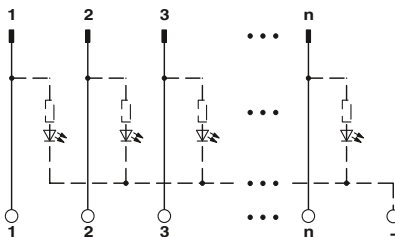



**10 to 20 positions
with screw connection and light indicator**



**26 to 64 positions
with screw connection**

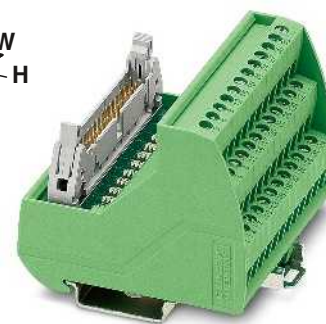

**26 to 64 positions
with screw connection and light indicator**



Technical data

24 V DC
1 A
-20°C ... 50°C
Any
IEC 60664, DIN EN 50178, IEC 62103
0.2 - 4 mm² / 0.2 - 2.5 mm² / 24 - 12
65.5 mm / 56 mm

Technical data

60 V AC/DC
1 A
-20°C ... 50°C
Any
IEC 60664, DIN EN 50178, IEC 62103
0.2 - 4 mm² / 0.2 - 2.5 mm² / 24 - 12
69 mm / 62 mm

Technical data

24 V DC
1 A
-20°C ... 50°C
Any
IEC 60664, DIN EN 50178, IEC 62103
0.2 - 4 mm² / 0.2 - 2.5 mm² / 24 - 12
69 mm / 62 mm

Ordering data

Ordering data

Ordering data

Type	Order No.	Pcs. / Pkt.
VIP-2/SC/FLK10/LED	2322045	1
VIP-2/SC/FLK14/LED	2322058	1
VIP-2/SC/FLK16/LED	2322061	1
VIP-2/SC/FLK20/LED	2322074	1

Type	Order No.	Pcs. / Pkt.
VIP-3/SC/FLK26	2315052	1
VIP-3/SC/FLK34	2315065	1
VIP-3/SC/FLK40	2315078	1
VIP-3/SC/FLK50	2315081	1
VIP-3/SC/FLK60	2315094	1
VIP-3/SC/FLK64	2315104	1

Type	Order No.	Pcs. / Pkt.
VIP-3/SC/FLK26/LED	2322087	1
VIP-3/SC/FLK34/LED	2322090	1
VIP-3/SC/FLK40/LED	2322100	1
VIP-3/SC/FLK50/LED	2322113	1
VIP-3/SC/FLK60/LED	2322126	1
VIP-3/SC/FLK64/LED	2322139	1

VARIOFACE wiring interface

VIP – VARIOFACE Professional Modules with flat-ribbon cable plug-in connectors

- 1:1 connection
 - 10- to 64-pos.
 - Push-in connection
 - Metal foot
 - As per IEC 60603-13
 - Optional with status indicator
- Low and high engagement latches are supplied with all modules.

Notes:

For marking systems (e.g., "ZB 22:UNBEDRUCKT"; Order No. 0811862) and mounting material, see Catalog 5.



10 to 20 positions with push-in connection

Operating voltage
Max. perm. current (per branch)
Ambient temperature (operation)
Mounting position
Standards/regulations
Connection data solid / stranded / AWG
Dimensions

Technical data

60 V AC/DC
1 A
-20°C ... 50°C
Any
IEC 60664, DIN EN 50178, IEC 62103
0.14 - 2.5 mm² / 0.14 - 2.5 mm² / 26 - 14
72.1 mm / 56 mm

H / D

Ordering data

Description	No. of pos.	Module width W
VARIOFACE module, with pin strip	10	36.80
	14	41.90
	16	46.90
	20	57.10
VARIOFACE module, with pin strip and light indicator	10	36.80
	14	41.90
	16	46.90
	20	57.10
VARIOFACE module, with pin strip	26	57.10
	34	67.30
	40	77.40
	50	92.70
	60	107.90
	64	118.10
VARIOFACE module, with pin strip and light indicator	26	57.10
	34	67.30
	40	77.40
	50	92.70
	60	107.90
	64	118.10

Type	Order No.	Pcs. / Pkt.
VIP-2/PT/FLK10	2903787	1
VIP-2/PT/FLK14	2903788	1
VIP-2/PT/FLK16	2903789	1
VIP-2/PT/FLK20	2903790	1

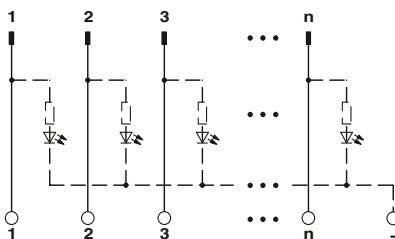



10 to 20 positions
with push-in connection and light indicator

N



26 to 64 positions
with push-in connection

N



26 to 64 positions
with push-in connection and light indicator

N

Technical data

24 V DC
1 A
-20°C ... 50°C
Any
IEC 60664, DIN EN 50178, IEC 62103
0.14 - 2.5 mm² / 0.14 - 2.5 mm² / 26 - 14
72.1 mm / 56 mm

Technical data

60 V AC/DC
1 A
-20°C ... 50°C
Any
IEC 60664, DIN EN 50178, IEC 62103
0.14 - 2.5 mm² / 0.14 - 2.5 mm² / 26 - 14
75.8 mm / 63 mm

Technical data

24 V DC
1 A
-20°C ... 50°C
Any
IEC 60664, DIN EN 50178, IEC 62103
0.14 - 2.5 mm² / 0.14 - 2.5 mm² / 26 - 14
75.8 mm / 63 mm

Ordering data

Type	Order No.	Pcs. / Pkt.
VIP-2/PT/FLK10/LED	2904248	1
VIP-2/PT/FLK14/LED	2904249	1
VIP-2/PT/FLK16/LED	2904250	1
VIP-2/PT/FLK20/LED	2904251	1

Ordering data

Type	Order No.	Pcs. / Pkt.
VIP-3/PT/FLK26	2903791	1
VIP-3/PT/FLK34	2903792	1
VIP-3/PT/FLK40	2903793	1
VIP-3/PT/FLK50	2903794	1
VIP-3/PT/FLK60	2903795	1
VIP-3/PT/FLK64	2903796	1

Ordering data

Type	Order No.	Pcs. / Pkt.
VIP-3/PT/FLK26/LED	2904252	1
VIP-3/PT/FLK34/LED	2904253	1
VIP-3/PT/FLK40/LED	2904254	1
VIP-3/PT/FLK50/LED	2904255	1
VIP-3/PT/FLK60/LED	2904256	1
VIP-3/PT/FLK64/LED	2904257	1

System cabling for controllers

VARIOFACE wiring interface

SLIM-LINE modules for flat-ribbon cable plug-in connectors

VARIOFACE SLIM-LINE modules connect flat-ribbon cable plug-in connectors in accordance with IEC 60603-13/DIN 41651 to front connection terminal blocks.

The modules are provided with low and high engagement latches to protect the flat-ribbon cable plug-in connector against being accidentally released.



20 and 26-pos.
with screw connection



34 to 50 positions
with screw connection

Operating voltage	
Max. perm. current (per branch)	
Ambient temperature (operation)	
Mounting position	
Standards/regulations	
Screw connection solid / stranded / AWG	
Dimensions	D / W



Technical data	
Operating voltage	< 50 V AC / 60 V DC
Max. perm. current (per branch)	0.8 A (data valid for 100% coincidence factor)
Ambient temperature (operation)	-10°C ... 50°C
Mounting position	Any
Standards/regulations	IEC 60664, DIN EN 50178, IEC 62103
Screw connection solid / stranded / AWG	0.2 ... 4 mm ² / 0.2 ... 2.5 mm ² / 24 - 12
Dimensions	45 mm / 25 mm

Ordering data		
Type	Order No.	Pcs. / Pkt.
UM 25-FLK20/Front/Q	2959515	1
UM-25 FLK26/Front/Q	2959528	1



Technical data	
Operating voltage	< 50 V AC / 60 V DC
Max. perm. current (per branch)	1 A (data valid for 100% coincidence factor)
Ambient temperature (operation)	-10°C ... 50°C
Mounting position	Any
Standards/regulations	IEC 60664, DIN EN 50178, IEC 62103
Screw connection solid / stranded / AWG	0.2 ... 4 mm ² / 0.2 ... 2.5 mm ² / 24 - 12
Dimensions	45 mm / 45 mm

Ordering data		
Type	Order No.	Pcs. / Pkt.
UM 45-FLK34/Front/Q	2959531	1
UM 45-FLK40/Front/Q	2959544	1
UM 45-FLK50/Front/Q	2959557	1

Description	No. of pos.	Module height H
VARIOFACE-SLIM-LINE module, with pin strip	20	177.00
	26	217.00
VARIOFACE-SLIM-LINE module, with pin strip	34	147.00
	40	167.00
	50	197.00

System cabling for controllers

VARIOFACE wiring interface

Panel feed-through modules for flat-ribbon cable plug-in connectors

VARIOFACE DFLK... panel feed-through modules connect the flat-ribbon cable plug-in connectors in accordance with IEC 60603-13/DIN 41651 to the screw connection terminal blocks.

These modules are suitable for mounting on a side panel with an appropriate housing cutout (see dimensioning table).

The modules are provided with low and high engagement latches to protect the flat-ribbon cable plug-in connector against being accidentally released.



16 to 50 positions
with screw connection

Technical data

Operating voltage	< 50 V AC / 60 V DC
Max. perm. current (per branch)	1 A
Ambient temperature (operation)	-20°C ... 50°C
Mounting position	Any
Standards/regulations	DIN EN 50178
Connection data solid / stranded / AWG	0.2 - 4 mm ² / 0.2 - 2.5 mm ² / 24 - 12

Ordering data

Description	No. of pos.	Module width W	Type	Order No.	Pcs. / Pkt.
VARIOFACE feed-through module, with pin strip					
	16	39.00	DFLK 16	2280239	5
	20	39.00	DFLK 20	2280242	5
	26	39.00	DFLK 26	2280255	5
	34	39.00	DFLK 34	2280268	5
	40	39.00	DFLK 40	2280271	5
	50	39.00	DFLK 50	2280284	5

Dimensioning of the housing cutout



Type	a	b	c	d
DFLK 16	58.4	52.5	40.1 + 0.2	9 + 0.2
DFLK 20	68.4	62.5	45.2 + 0.2	9 + 0.2
DFLK 26	83.4	77.5	52.8 + 0.2	9 + 0.2
DFLK 34	103.4	97.5	63.0 + 0.2	9 + 0.2
DFLK 40	128.4	122.5	70.6 + 0.2	9 + 0.2
DFLK 50	143.4	137.5	83.3 + 0.2	9 + 0.2

Dimensional drawing DFLK:



Feed-through modules for IDC/FLK plug-in connectors (pitch 2.54 mm) with spring-cage connection

- 1:1 connection
- 10- to 50-pos.
- Plug-in push-in spring-cage connection
- Plug-in connectors as per IEC 60603-13
- Short and long latches are supplied with the module
- Select housing cutout for side panel mounting according to dimensions table



With pin strip and push-in spring-cage connection

Technical data

Operating voltage	< 50 V AC / 60 V DC
Max. perm. current (per branch)	1 A
Ambient temperature (operation)	-20°C ... 50°C
Mounting position	Any
Standards/regulations	DIN EN 50178
Connection data solid / stranded / AWG	0.2 - 2.5 mm ² / 0.2 - 2.5 mm ² / 24 - 12

Ordering data

Description	No. of pos.	Module width W	Type	Order No.	Pcs. / Pkt.
VARIOFACE feed-through module, with pin strip					
	10	36.50	DFLK 10/FKCT	2903034	1
	14	36.50	DFLK 14/FKCT	2903035	1
	16	36.50	DFLK 16/FKCT	2903036	1
	20	36.50	DFLK 20/FKCT	2903038	1
	26	36.50	DFLK 26/FKCT	2903039	1
	34	36.50	DFLK 34/FKCT	2903041	1
	40	36.50	DFLK 40/FKCT	2903042	1
	50	36.50	DFLK 50/FKCT	2903043	1

Dimensioning of the housing cutout



Dimensional drawing DFLK...FKCT

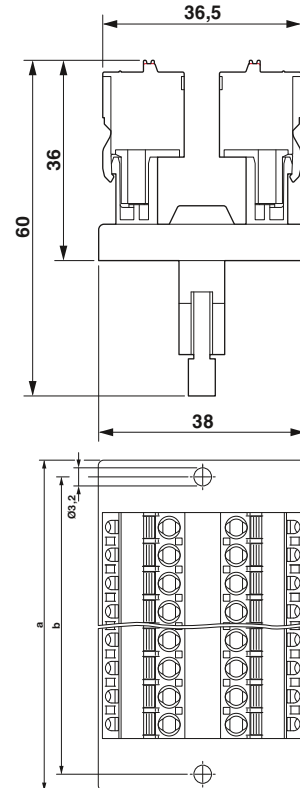

Type	a	b	c	d
DFLK 10/FKCT	58.4	52.5	40.1 + 0.2	9 + 0.2
DFLK 14/FKCT	58.4	52.5	40.1 + 0.2	9 + 0.2
DFLK 16/FKCT	58.4	52.5	40.1 + 0.2	9 + 0.2
DFLK 20/FKCT	68.4	62.5	45.2 + 0.2	9 + 0.2
DFLK 26/FKCT	83.4	77.5	52.8 + 0.2	9 + 0.2
DFLK 34/FKCT	103.4	97.5	63.0 + 0.2	9 + 0.2
DFLK 40/FKCT	128.4	122.5	70.6 + 0.2	9 + 0.2
DFLK 50/FKCT	143.4	137.5	83.3 + 0.2	9 + 0.2

VARIOFACE wiring interface

VIP – VARIOFACE Professional Modules with D-SUB plug-in connectors

- 1:1 connection
 - 9- to 50-pos.
 - Screw connection
 - Metal foot
 - As per IEC 60807-2
 - Optional with status indicator
- The D-SUB-4-40 UNC threads are guided directly onto a connection terminal block.

Notes:

For marking systems (e.g., "ZB 22:UNBEDRUCKT"; Order No. 0811862) and mounting material, see Catalog 5.



9 to 15 positions
with screw connection



Technical data

Operating voltage	125 V AC/DC
Max. perm. current (per branch)	2 A
Ambient temperature (operation)	-20°C ... 50°C
Mounting position	Any
Standards/regulations	IEC 60664, DIN EN 50178, IEC 62103
Connection data solid / stranded / AWG	0.2 - 4 mm ² / 0.2 - 2.5 mm ² / 24 - 12
Dimensions	H / D 65.5 mm / 45.1 mm

Ordering data

Description	No. of pos.	Module width W	Type	Order No.	Pcs. / Pkt.
VARIOFACE module , with D-SUB miniature pin strip	9	34.70	VIP-2/SC/D 9SUB/M	2315117	1
	15	45.00			
VARIOFACE module , with D-SUB miniature pin strip and light indicator	9	34.70			
	15	50.00			
VARIOFACE module , with D-SUB miniature socket strip	9	34.70	VIP-2/SC/D 9SUB/F	2315162	1
	15	45.00			
VARIOFACE module , with D-SUB miniature socket strip and light indicator	9	34.70			
	15	50.00			
VARIOFACE module , with D-SUB miniature pin strip	25	57.40			
	37	72.70			
	50	98.20			
VARIOFACE module , with D-SUB miniature pin strip and light indicator	25	57.40			
	37	72.70			
	50	98.20			
VARIOFACE module , with D-SUB miniature socket strip	25	57.40			
	37	72.70			
	50	98.20			
VARIOFACE module , with D-SUB miniature socket strip and light indicator	25	57.40			
	37	72.70			
	50	98.20			

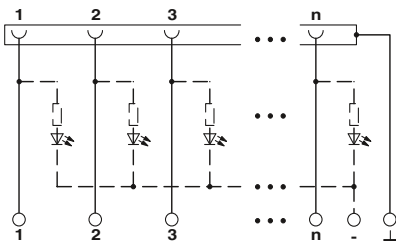



9 to 15 positions
with screw connection and light indicator



25 to 50 positions
with screw connection



25 to 50 positions
with screw connection and light indicator



Technical data

24 V DC
2.5 A
-20°C ... 50°C
Any
IEC 60664, DIN EN 50178, IEC 62103
0.2 - 4 mm² / 0.2 - 2.5 mm² / 24 - 12
65.5 mm / 45.1 mm

Technical data

125 V AC/DC
2 A
-20°C ... 50°C
Any
IEC 60664, DIN EN 50178, IEC 62103
0.2 - 4 mm² / 0.2 - 2.5 mm² / 24 - 12
69 mm / 62 mm

Technical data

24 V DC
2.5 A
-20°C ... 50°C
Any
IEC 60664, DIN EN 50178, IEC 62103
0.2 - 4 mm² / 0.2 - 2.5 mm² / 24 - 12
69 mm / 62 mm

Ordering data

Ordering data

Ordering data

Type	Order No.	Pcs. / Pkt.
VIP-2/SC/D 9SUB/M/LED	2322142	1
VIP-2/SC/D15SUB/M/LED	2322155	1
VIP-2/SC/D 9SUB/F/LED	2322197	1
VIP-2/SC/D15SUB/F/LED	2322207	1

Type	Order No.	Pcs. / Pkt.
VIP-3/SC/D25SUB/M	2315133	1
VIP-3/SC/D37SUB/M	2315146	1
VIP-3/SC/D50SUB/M	2315159	1
VIP-3/SC/D25SUB/F	2315188	1
VIP-3/SC/D37SUB/F	2315191	1
VIP-3/SC/D50SUB/F	2315201	1

Type	Order No.	Pcs. / Pkt.
VIP-3/SC/D25SUB/M/LED	2322168	1
VIP-3/SC/D37SUB/M/LED	2322171	1
VIP-3/SC/D50SUB/M/LED	2322184	1
VIP-3/SC/D25SUB/F/LED	2322210	1
VIP-3/SC/D37SUB/F/LED	2322223	1
VIP-3/SC/D50SUB/F/LED	2322236	1

VARIOFACE wiring interface

VIP – VARIOFACE Professional Modules with D-SUB plug-in connectors

- 1:1 connection
 - 9- to 50-pos.
 - Push-in connection
 - Metal foot
 - As per IEC 60807-2
 - Optional with status indicator
- The D-SUB-4-40 UNC threads are guided directly onto a connection terminal block.

Notes:

For marking systems (e.g., "ZB 22:UNBEDRUCKT"; Order No. 0811862) and mounting material, see Catalog 5.



N



9 to 15 positions with push-in connection

Operating voltage
Max. perm. current (per branch)
Ambient temperature (operation)
Mounting position
Standards/regulations
Connection data solid / stranded / AWG
Dimensions

Technical data

125 V AC/DC
2 A
-20°C ... 50°C
Any
IEC 60664, DIN EN 50178, IEC 62103
0.14 - 2.5 mm² / 0.14 - 2.5 mm² / 26 - 14
72.1 mm / 46.6 mm

Ordering data

Description	No. of pos.	Module width W	Type	Order No.	Pcs. / Pkt.
VARIOFACE module , with D-SUB miniature pin strip					
	9	36.80	VIP-2/PT/D 9SUB/M	2903777	1
	15	46.90	VIP-2/PT/D15SUB/M	2903779	1
VARIOFACE module , with D-SUB miniature pin strip and light indicator					
	9	36.80			
	15	52.00			
VARIOFACE module , with D-SUB miniature socket strip					
	9	36.80	VIP-2/PT/D 9SUB/F	2903778	1
	15	46.90	VIP-2/PT/D15SUB/F	2903780	1
VARIOFACE module , with D-SUB miniature socket strip and light indicator					
	9	36.80			
	15	52.00			
VARIOFACE module , with D-SUB miniature pin strip					
	25	57.10			
	37	72.30			
	50	97.70			
VARIOFACE module , with D-SUB miniature pin strip and light indicator					
	25	57.10			
	37	72.30			
	50	97.70			
VARIOFACE module , with D-SUB miniature socket strip					
	25	57.10			
	37	72.30			
	50	97.70			
VARIOFACE module , with D-SUB miniature socket strip and light indicator					
	25	57.10			
	37	72.30			
	50	97.70			

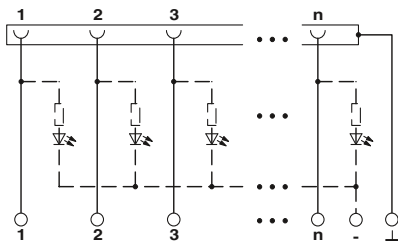



9 to 15 positions
with push-in connection and light indicator

N

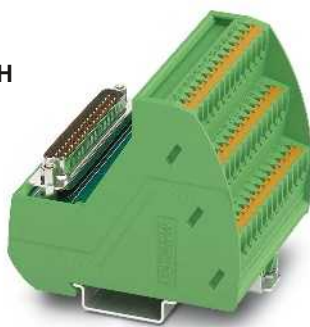

25 to 50 positions
with push-in connection

N

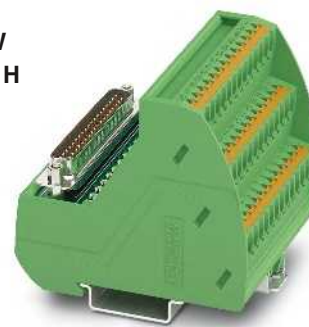

25 to 50 positions
with push-in connection and light indicator

N

Technical data

24 V DC
2 A
-20°C ... 50°C
Any
IEC 60664, DIN EN 50178, IEC 62103
0.14 - 2.5 mm² / 0.14 - 2.5 mm² / 26 - 14
72.1 mm / 46.6 mm

Technical data

125 V AC/DC
2 A
-20°C ... 50°C
Any
IEC 60664, DIN EN 50178, IEC 62103
0.14 - 2.5 mm² / 0.14 - 2.5 mm² / 26 - 14
75.8 mm / 63 mm

Technical data

24 V DC
2 A
-20°C ... 50°C
Any
IEC 60664, DIN EN 50178, IEC 62103
0.14 - 2.5 mm² / 0.14 - 2.5 mm² / 26 - 14
75.8 mm / 63 mm

Ordering data

Type	Order No.	Pcs. / Pkt.
VIP-2/PT/D 9SUB/M/LED	2904258	1
VIP-2/PT/D15SUB/M/LED	2904259	1
VIP-2/PT/D 9SUB/F/LED	2904263	1
VIP-2/PT/D15SUB/F/LED	2904264	1

Ordering data

Type	Order No.	Pcs. / Pkt.
VIP-3/PT/D25SUB/M	2903781	1
VIP-3/PT/D37SUB/M	2903783	1
VIP-3/PT/D50SUB/M	2903785	1
VIP-3/PT/D25SUB/F	2903782	1
VIP-3/PT/D37SUB/F	2903784	1
VIP-3/PT/D50SUB/F	2903786	1

Ordering data

Type	Order No.	Pcs. / Pkt.
VIP-3/PT/D25SUB/M/LED	2904260	1
VIP-3/PT/D37SUB/M/LED	2904261	1
VIP-3/PT/D50SUB/M/LED	2904262	1
VIP-3/PT/D25SUB/F/LED	2904265	1
VIP-3/PT/D37SUB/F/LED	2904266	1
VIP-3/PT/D50SUB/F/LED	2904267	1

System cabling for controllers

VARIOFACE wiring interface

SLIM-LINE modules for D-subminiature plug-in connectors

These VARIOFACE modules connect D-SUB strips with front connection terminal blocks in accordance with IEC 60807-2/DIN 41652.

To make the ground connection, the metallic plug shell (4-40 UNC thread) makes contact with a connection terminal block.



9 to 25 positions
With screw connection



37 to 50 positions
With screw connection

Operating voltage	
Max. perm. current (per branch)	
Ambient temperature (operation)	
Mounting position	
Standards/regulations	
Dimensions	D / W



Technical data	
Operating voltage	125 V AC/DC
Max. perm. current (per branch)	2.5 A
Ambient temperature (operation)	-10°C ... 50°C
Mounting position	Any
Standards/regulations	IEC 60664, IEC 60664 A, DIN VDE 0110, DIN VDE 0160 (in parts)
Dimensions	45 mm / 25 mm

Ordering data		
---------------	--	--

Type	Order No.	Pcs. / Pkt.
UM 25-D 9SUB/S/Front/Q	2959573	1
UM 25-D15SUB/S/Front/Q	2959599	1
UM 25-D25SUB/S/Front/Q	2959612	1
UM 25-D 9SUB/B/Front/Q	2959560	1
UM 25-D15SUB/B/Front/Q	2959586	1
UM 25-D25SUB/B/Front/Q	2959609	1



Technical data	
Operating voltage	125 V AC/DC
Max. perm. current (per branch)	2.5 A
Ambient temperature (operation)	-10°C ... 50°C
Mounting position	Any
Standards/regulations	IEC 60664, DIN EN 50178, IEC 62103
Dimensions	45 mm / 45 mm

Ordering data		
---------------	--	--

Type	Order No.	Pcs. / Pkt.
UM 45-D37SUB/S/Front/Q	2959638	1
UM 45-D50SUB/S/Front/Q	2959654	1
UM 45-D37SUB/B/Front/Q	2959625	1
UM 45-D50SUB/B/Front/Q	2959641	1

Description	No. of pos.	Module height H
VARIOFACE-SLIM-LINE module, with D-SUB miniature pin strip	9	117.00
	15	147.00
	25	217.00
VARIOFACE-SLIM-LINE module, with D-SUB miniature socket strip	9	117.00
	15	147.00
	25	217.00
VARIOFACE-SLIM-LINE module, with D-SUB miniature pin strip	37	157.00
	50	187.00
VARIOFACE-SLIM-LINE module, with D-SUB miniature socket strip	37	157.00
	50	187.00

Feed-through modules for D-SUB miniature plug-in connectors with screw connection

- 1:1 connection
- 9- to 50-pos.
- Screw connection
- As per IEC 60807-2
- D-SUB 4-40 UNC thread
- 9- to 37-pos.: Separate ground tap
- 50-pos.: No ground tap



With D-subminiature pin strip



With D-subminiature socket strip

Operating voltage	125 V AC/DC
Max. perm. current (per branch)	2.5 A
Ambient temperature (operation)	-20°C ... 50°C
Mounting position	Any
Standards/regulations	DIN EN 50178
Connection data solid / stranded / AWG	0.2 - 4 mm ² / 0.2 - 2.5 mm ² / 24 - 12

Technical data

Operating voltage	125 V AC/DC
Max. perm. current (per branch)	2.5 A
Ambient temperature (operation)	-20°C ... 50°C
Mounting position	Any
Standards/regulations	DIN EN 50178
Connection data solid / stranded / AWG	0.2 - 4 mm ² / 0.2 - 2.5 mm ² / 24 - 12

Technical data

Operating voltage	125 V AC/DC
Max. perm. current (per branch)	2.5 A
Ambient temperature (operation)	-20°C ... 50°C
Mounting position	Any
Standards/regulations	DIN EN 50178
Connection data solid / stranded / AWG	0.2 - 4 mm ² / 0.2 - 2.5 mm ² / 24 - 12

Description	No. of pos.	Module width W
VARIOFACE feed-through module, with D-subminiature plug-in connector		
	9	39.00
	15	39.00
	25	39.00
	37	39.00
	50	39.00

Ordering data

Type	Order No.	Pcs. / Pkt.
DFLK-D 9 SUB/S	2283870	5
DFLK-D15 SUB/S	2280297	5
DFLK-D25 SUB/S	2280310	5
DFLK-D37 SUB/S	2280336	5
DFLK-D50 SUB/S	2291286	5

Ordering data

Type	Order No.	Pcs. / Pkt.
DFLK-D 9 SUB/B	2287135	5
DFLK-D15 SUB/B	2280307	5
DFLK-D25 SUB/B	2280323	5
DFLK-D37 SUB/B	2280349	5
DFLK-D50 SUB/B	2287669	5

Dimensioning of the housing cutout

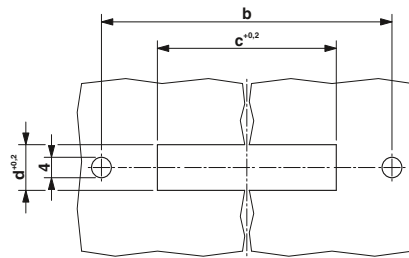

Type	a	b	c	d
DFLK-D 9 SUB/S	58.4	52.5	40.2 + 0.2	13 + 0.2
DFLK-D 15 SUB/S	58.4	52.5	40.2 + 0.2	13 + 0.2
DFLK-D 25 SUB/S	83.4	77.5	54.2 + 0.2	13 + 0.2
DFLK-D 37 SUB/S	128.4	122.5	70.6 + 0.2	13 + 0.2
DFLK-D 50 SUB/S	143.4	137.5	67.8 + 0.2	15.8 + 0.2
DFLK-D 9 SUB/B	58.4	52.5	40.2 + 0.2	13 + 0.2
DFLK-D 15 SUB/B	58.4	52.5	40.2 + 0.2	13 + 0.2
DFLK-D 25 SUB/B	83.4	77.5	54.2 + 0.2	13 + 0.2
DFLK-D 37 SUB/B	128.4	122.5	70.6 + 0.2	13 + 0.2
DFLK-D 50 SUB/B	143.4	137.5	67.8 + 0.2	15.8 + 0.2

Dimensional drawing: DFLK-D...SUB:

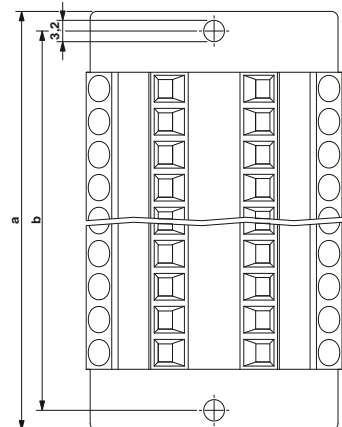
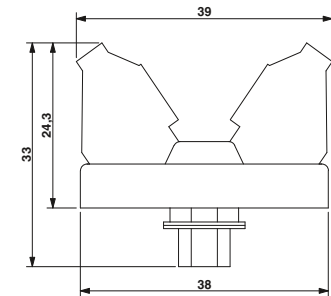

System cabling for controllers

VARIOFACE wiring interface

Feed-through modules for D-SUB miniature plug-in connectors with push-in connection

- 1:1 connection
- 9- to 50-pos.
- Plug-in push-in spring-cage connection
- Plug-in connector according to IEC 60807-2
- D-SUB 4-40 UNC thread
- 9- to 37-pos. with separate ground tap
- 50-pos.: No ground tap
- Select housing cutout for side panel mounting according to dimensions table



With D-SUB pin strip and push-in connection



With D-SUB socket strip and push-in connection

Operating voltage
Max. perm. current (per branch)
Ambient temperature (operation)
Mounting position
Standards/regulations
Connection data solid / stranded / AWG

125 V AC/DC
2.5 A
-20°C ... 50°C
Any
DIN EN 50178
0.2 - 2.5 mm² / 0.2 - 2.5 mm² / 24 - 12

125 V AC/DC
2.5 A
-20°C ... 50°C
Any
DIN EN 50178
0.2 - 2.5 mm² / 0.2 - 2.5 mm² / 24 - 12

Description	No. of pos.	Module width W
VARIOFACE feed-through module, with D-subminiature plug-in connector		
	9	36.50
	15	36.50
	25	36.50
	37	36.50
	50	36.50

Ordering data		
Type	Order No.	Pcs. / Pkt.
DFLK-D 9 SUB/M/FKCT	2903052	1
DFLK-D15 SUB/M/FKCT	2903054	1
DFLK-D25 SUB/M/FKCT	2903055	1
DFLK-D37 SUB/M/FKCT	2903056	1
DFLK-D50 SUB/M/FKCT	2903058	1

Ordering data		
Type	Order No.	Pcs. / Pkt.
DFLK-D 9 SUB/F/FKCT	2903063	1
DFLK-D15 SUB/F/FKCT	2903065	1
DFLK-D25 SUB/F/FKCT	2903067	1
DFLK-D37 SUB/F/FKCT	2903069	1
DFLK-D50 SUB/F/FKCT	2903070	1

Dimensioning of the housing cutout

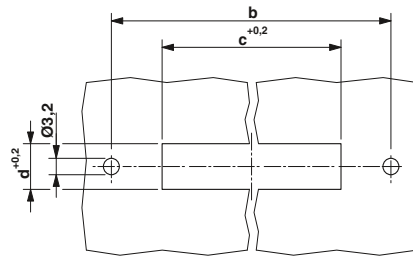

Type	a	b	c	d
DFLK-D 9 SUB/M/FKCT	58.4	52.5	40.2 + 0.2	13 + 0.2
DFLK-D15 SUB/M/FKCT	58.4	52.5	40.2 + 0.2	13 + 0.2
DFLK-D25 SUB/M/FKCT	83.4	77.5	54.2 + 0.2	13 + 0.2
DFLK-D37 SUB/M/FKCT	128.4	122.5	70.6 + 0.2	13 + 0.2
DFLK-D50 SUB/M/FKCT	143.4	137.5	67.8 + 0.2	15.8 + 0.2
DFLK-D 9 SUB/F/FKCT	58.4	52.5	40.2 + 0.2	13 + 0.2
DFLK-D15 SUB/F/FKCT	58.4	52.5	40.2 + 0.2	13 + 0.2
DFLK-D25 SUB/F/FKCT	83.4	77.5	54.2 + 0.2	13 + 0.2
DFLK-D37 SUB/F/FKCT	128.4	122.5	70.6 + 0.2	13 + 0.2
DFLK-D50 SUB/F/FKCT	143.4	137.5	67.8 + 0.2	15.8 + 0.2

Dimensional drawing DFLK-D...SUB...FKCT

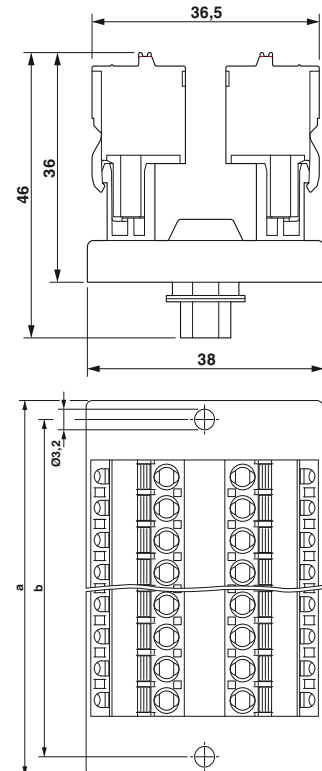

VIP – VARIOFACE Professional modules for high density D-SUB miniature plug-in connectors

- 1:1 connection
- 15- to 62-pos.
- Screw and push-in connection
- Metal foot

The D-SUB-4-40 UNC threads are guided directly onto a connection terminal block.

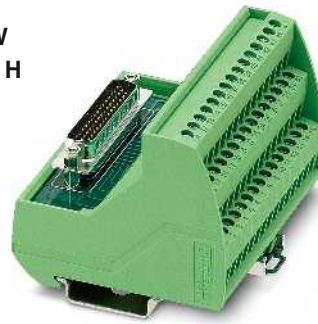

15 to 62 positions
with screw connection

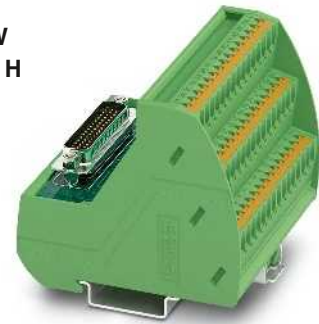

15 to 62 positions
with push-in connection

Notes:

For marking systems (e.g., "ZB 22:UNBEDRUCKT"; Order No. 0811862) and mounting material, see Catalog 5.

1) Module with double-level terminal blocks



Operating voltage
Max. perm. current (per branch)
Ambient temperature (operation)
Mounting position
Connection data solid / stranded / AWG
Dimensions

H / D

Technical data

125 V AC/DC
1 A
-20°C ... 50°C
Any
0.2 - 4 mm² / 0.2 - 2.5 mm² / 24 - 12
69 mm / 62 mm

Technical data

125 V AC/DC
1 A
-20°C ... 50°C
Any
0.14 - 2.5 mm² / 0.14 - 2.5 mm² / 26 - 14
75.8 mm / 63 mm

Ordering data

Type	Order No.	Pcs. / Pkt.
VIP-2/SC/HD15SUB/M	2322326	1
VIP-3/SC/HD26SUB/M	2322375	1
VIP-3/SC/HD44SUB/M	2322388	1
VIP-3/SC/HD62SUB/M	2322391	1
VIP-2/SC/HD15SUB/F	2322401	1
VIP-3/SC/HD26SUB/F	2322414	1
VIP-3/SC/HD44SUB/F	2322427	1
VIP-3/SC/HD62SUB/F	2322430	1

Ordering data

Type	Order No.	Pcs. / Pkt.
VIP-2/PT/HD15SUB/M	2904268	1
VIP-3/PT/HD26SUB/M	2904269	1
VIP-3/PT/HD44SUB/M	2904270	1
VIP-3/PT/HD62SUB/M	2904271	1
VIP-2/PT/HD15SUB/F	2904272	1
VIP-3/PT/HD26SUB/F	2904273	1
VIP-3/PT/HD44SUB/F	2904274	1
VIP-3/PT/HD62SUB/F	2904275	1

Description	No. of pos.	Module width W
VARIOFACE module, with D-SUB miniature pin strip		
With screw connection 1)	15	44.90
With screw connection	26	52.30
With screw connection	44	82.90
With screw connection	62	113.50
With push-in connection 1)	15	46.90
With push-in connection	26	52.00
With push-in connection	44	82.50
With push-in connection	62	113.00
VARIOFACE module, with D-SUB miniature socket strip		
With screw connection 1)	15	44.90
With screw connection	26	52.30
With screw connection	44	82.90
With screw connection	62	113.50
With push-in connection 1)	15	46.90
With push-in connection	26	52.00
With push-in connection	44	82.50
With push-in connection	62	113.00

VARIOFACE wiring interface

Modules for plug-in connectors IEC 60603/DIN 41612

These VARIOFACE interface modules connect high-position plug-in connectors according to IEC 60603/DIN 41612 to screw connection terminal blocks.

The following VARIOFACE modules are available:

- **UMK** modules with double-level connection terminal blocks
- **UMKS** modules with three-level connection terminal blocks.

Notes:

For suitable cable housings, see the table on page 562

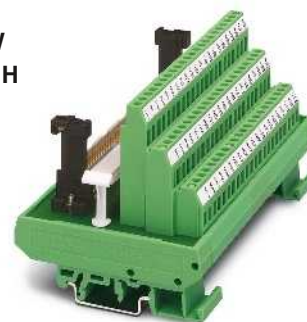

**Design C,
64-position, a, c assembled**



Technical data

Operating voltage	125 V AC/DC
Max. perm. current (per branch)	1 A
Ambient temperature (operation)	-20°C ... 50°C
Mounting position	Any
Standards/regulations	IEC 60664, DIN EN 50178, IEC 62103
Connection data solid / stranded / AWG	0.2 - 4 mm ² / 0.2 - 2.5 mm ² / 24 - 12
Dimensions	H / D 77 mm / 72 mm

Ordering data

Description	No. of pos.	Module width W
VARIOFACE module, C 64-pos., screw-on cable housing, with:		
- Pin strip	64	135.00
VARIOFACE module, E 48-pos., screw-on cable housing, with:		
- Pin strip	48	123.80
VARIOFACE module, F 48-pos., screw-on cable housing, with:		
- Pin strip	48	112.50
VARIOFACE module, F 48-pos., snap-on cable housing, with:		
- Pin strip	48	112.50
VARIOFACE module, D 32-pos., screw-on cable housing, with:		
- Pin strip	32	135.00

Type	Order No.	Pcs. / Pkt.
UMKS- C64M-VS	2970565	1

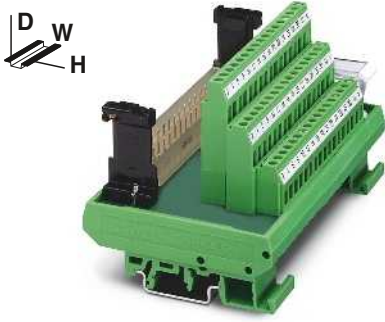

Design E,
48-position, a, c, e assembled

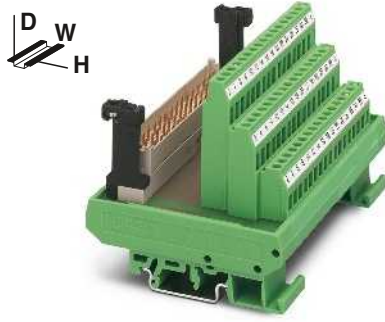

Design F,
48-position, z, b, d assembled

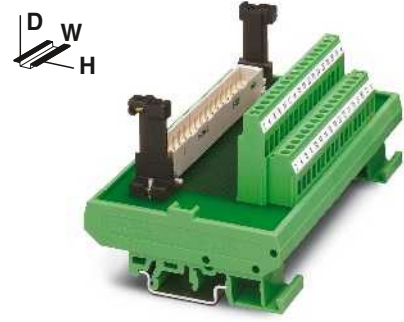

Design D,
32-position, a, c assembled



Technical data
125 V AC/DC
4 A
-20°C ... 50°C
Any
IEC 60664, DIN EN 50178, IEC 62103
0.2 - 4 mm ² / 0.2 - 2.5 mm ² / 24 - 12
77 mm / 72 mm

Technical data
250 V AC
4 A
-20°C ... 45°C
Any
IEC 60664, DIN EN 50178, IEC 62103
0.2 - 4 mm ² / 0.2 - 2.5 mm ² / 24 - 12
77 mm / 72 mm

Technical data
250 V AC/DC
2 A
-20°C ... 50°C
Any
IEC 60664, DIN EN 50178, IEC 62103
0.2 - 4 mm ² / 0.2 - 2.5 mm ² / 24 - 12
77 mm / 62.5 mm

Ordering data		
Type	Order No.	Pcs. / Pkt.
UMKS- E48M-VS	2970154	1

Ordering data		
Type	Order No.	Pcs. / Pkt.
UMKS- F48M-VS	2970714	1
UMKS- F48M-VR	2970167	1

Ordering data		
Type	Order No.	Pcs. / Pkt.
UMK- D32M-VS	2970060	1

System cabling for controllers

VARIOFACE wiring interface

Modules for ELCO plug-in connectors

Notes:
Dimensional drawings and pin assignments, see page 562

These modules can be used to connect ELCO plug-in connectors of the 8016 series to screw connection terminal blocks.

The diagonal position of the ELCO plug-in connector means that the wires leading out of the cable housing at the side can be led away without restricting neighboring modules.

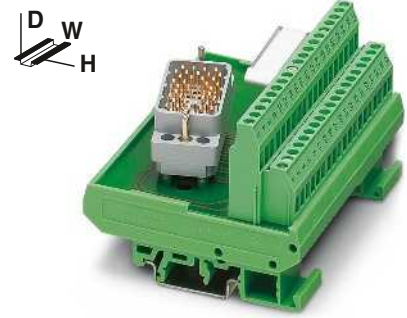

38-pos.



Technical data

Operating voltage	25 V AC / 60 V DC
Max. perm. current (per branch)	1.5 A
Total current	19 A (38 branches with 0.5 A each)
Ambient temperature (operation)	-20°C ... 40°C
Mounting position	Any
Standards/regulations	IEC 60664, DIN EN 50178, IEC 62103
Connection data solid / stranded / AWG	0.2 - 4 mm ² / 0.2 - 2.5 mm ² / 24 - 12
Dimensions	77 mm / 58.5 mm

H / D

Ordering data

Description	No. of pos.	Module width W	Type	Order No.	Pcs. / Pkt.
VARIOFACE module, with:					
- Pin strip 8016 right	38	101.50	UMK- EC38/38-XOR	2976297	1
- Pin strip 8016 left	38	101.50	UMK- EC38/38-XOL	2976284	1
VARIOFACE module, with:					
- Pin strip 8016 right	56	157.50			
- Pin strip 8016 left	56	157.50			
VARIOFACE module, with:					
- Pin strip 8016 right	56	77.00			
- Pin strip 8016 left	56	77.00			
VARIOFACE module, with:					
- Pin strip 8016 right above	32	101.30			
- Pin strip 8016 right below	32	101.30			
- Pin strip 8016 left above	32	101.30			
- Pin strip 8016 left below	32	101.30			

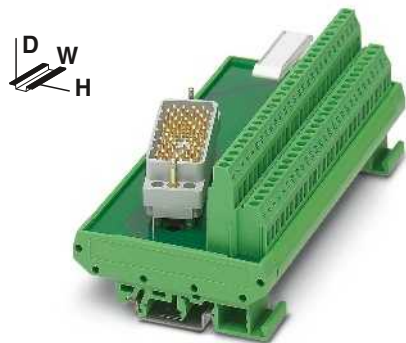

56-pos.

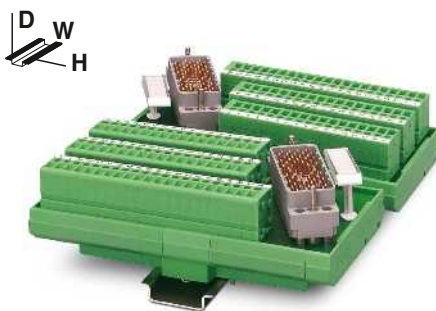

56-pos.,
with front connection terminal blocks

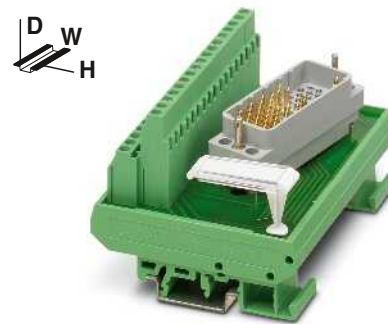

32-pos.



Technical data

125 V AC/DC
1.5 A
28 A (56 branches with 0.5 A each)
-20°C ... 50°C
Any
IEC 60664, DIN EN 50178, IEC 62103
0.2 - 4 mm² / 0.2 - 2.5 mm² / 24 - 12
77 mm / 58.5 mm

Technical data

< 25 V AC / 30 V DC
1.5 A
28 A (56 branches with 0.5 A each)
-20°C ... 50°C
Any
IEC 60664, DIN EN 50178, IEC 62103
0.2 - 2.5 mm² / 0.2 - 1.5 mm² / 26 - 16
146.3 mm / 47.5 mm

Technical data

25 V AC / 60 V DC
2 A
32 A (32 branches with 1 A each)
-20°C ... 40°C
Any
IEC 60664, DIN EN 50178, IEC 62103
0.2 - 4 mm² / 0.2 - 2.5 mm² / 24 - 12
77 mm / 58.5 mm

Ordering data

Type	Order No.	Pcs. / Pkt.
UMK- EC56/56-XOR	2975900	1
UMK- EC56/56-XOL	2975890	1

Ordering data

Type	Order No.	Pcs. / Pkt.
UMK- EC56/FRONT 2,5V/R	2976161	1
UMK- EC56/FRONT 2,5V/L	2976158	1

Ordering data

Type	Order No.	Pcs. / Pkt.
UMK- EC56/32-XOR	2975858	1
UMK- EC56/32-XUR	2975777	1
UMK- EC56/32-XOL	2975764	1
UMK- EC56/32-XUL	2975780	1

VARIOFACE wiring interface

Modules for ELCO plug-in connectors for use in Ex i circuits

The VARIOFACE modules connect ELCO plug-in connectors of the 8016 series to screw connection terminal blocks. The modules for ELCO connectors can be used as simple electrical equipment for applications in intrinsically safe circuits as per EN 60079-14. They fulfill the requirements of intrinsic safety as per EN 60079-11 (EN 50020) and can be used for various intrinsically safe circuits taking into account the pin configuration.

The voltage of an intrinsically safe circuit may not exceed 30 V. The voltage difference between two intrinsically safe circuits can be up to 60 V.

The modules are equipped with blue screw connection methods are clear labeling for intrinsically safe circuits.

The arrangement of angled ELCO plug-in connectors makes it possible to lead the lines led out from the cable housing away from the adjacent modules without any negative effects.

For the disconnection of intrinsically safe and non-intrinsically safe circuits, a distance of at least 50 mm should be kept between the connection points using partition plates or spaces.

Notes:
Dimensional drawings and pin assignments, see page 563
Facts about explosion protection, see page 154

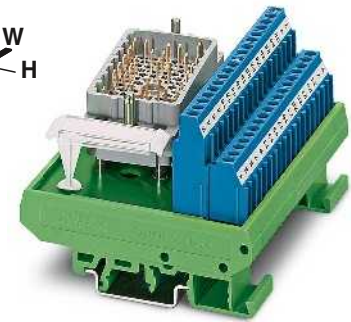

32-pos.

Operating voltage

Max. perm. current (per branch)	
Ambient temperature (operation)	
Mounting position	
Standards/regulations	
Connection data solid / stranded / AWG	
Dimensions	H / D

Technical data

max. 30 V DC (Max. voltage between two intrinsically safe circuits: 60 V DC)
500 mA
-20°C ... 50°C
Any
DIN EN 60079-11
0.2 - 4 mm ² / 0.2 - 2.5 mm ² / 24 - 12
77 mm / 58.5 mm

Description	No. of pos.	Module width W
VARIOFACE module, with:		
- Pin strip 8016 right above	32	101.30
- Pin strip 8016 right below	32	101.30
- Pin strip 8016 left above	32	101.30
- Pin strip 8016 left below	32	101.30
VARIOFACE module, with:		
- Pin strip 8016 right	25	78.80
- Pin strip 8016 left	25	78.80
VARIOFACE module, with:		
- Pin strip 8016 right	25	77.00
- Pin strip 8016 left	25	77.00

Ordering data

Type	Order No.	Pcs. / Pkt.
UMK- EC90/32/EX-XOR	2900109	1
UMK- EC90/32/EX-XUR	2969068	1
UMK- EC90/32/EX-XOL	2900110	1
UMK- EC90/32/EX-XUL	2969071	1

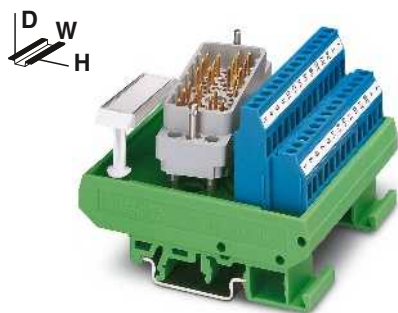

25-pos.

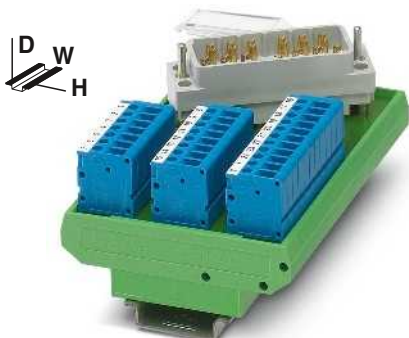

25-pos.,
with front connection terminal blocks

Technical data

max. 30 V DC
(Max. voltage between two intrinsically safe circuits: 60 V DC)
500 mA
-20°C ... 50°C
Any
DIN EN 60079-11
0.2 - 4 mm² / 0.2 - 2.5 mm² / 24 - 12
77 mm / 58.5 mm

Ordering data

Type	Order No.	Pcs. / Pkt.
UMK- EC56/25/EX -R	2900112	1
UMK- EC56/25/EX -L	2900113	1

Technical data

max. 30 V DC
(Max. voltage between two intrinsically safe circuits: 60 V DC)
500 mA
-20°C ... 50°C
Any
DIN EN 60079-11
0.2 - 2.5 mm² / 0.2 - 2.5 mm² / 24 - 14
112.5 mm / 52.5 mm

Ordering data

Type	Order No.	Pcs. / Pkt.
UMK- EC56/25/EX -FRONT 2,5V/R	2900114	1
UMK- EC56/25/EX -FRONT 2,5V/L	2900115	1

VARIOFACE wiring interface

Modules with RJ45 plug-in connector

- 1:1 connection
- 8-positions, RJ45 connector
- Screw or push-in connection (direct plug-in technology)
- Connector housing led to separate connection terminal blocks

Notes:
For marking systems (e.g., "ZB 22:UNBEDRUCKT"; Order No. 0811862) and mounting material, see Catalog 5.



8-pos.
with screw connection

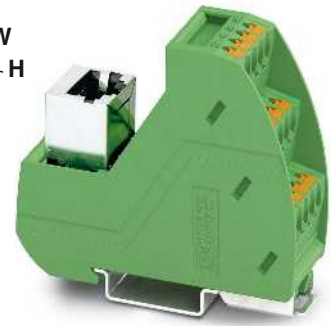

8-pos.
with push-in connection

N

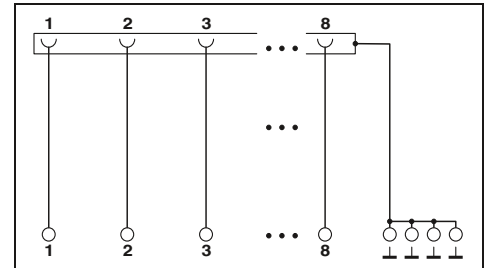
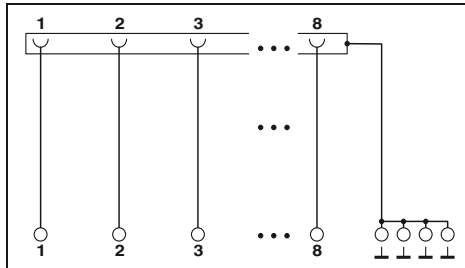

Technical data	
Operating voltage	48 V AC/DC
Max. perm. current (per branch)	1 A
Ambient temperature (operation)	-20°C ... 50°C
Mounting position	Any
Standards/regulations	DIN EN 50178
Connection data solid / stranded / AWG	0.2 - 4 mm ² / 0.2 - 2.5 mm ² / 24 - 12
Dimensions	69 mm / 62 mm

Technical data	
Operating voltage	48 V AC/DC
Max. perm. current (per branch)	1 A
Ambient temperature (operation)	-20°C ... 50°C
Mounting position	Any
Standards/regulations	EN 50178
Connection data solid / stranded / AWG	0.14 - 2.5 mm ² / 0.14 - 2.5 mm ² / 26 - 14
Dimensions	75.8 mm / 63 mm

Ordering data		
Type	Order No.	Pcs. / Pkt.
VIP-3/SC/RJ45	2900701	1

Ordering data		
Type	Order No.	Pcs. / Pkt.
VIP-3/PT/RJ45	2904290	1

Operating voltage		
Max. perm. current (per branch)		
Ambient temperature (operation)		
Mounting position		
Standards/regulations		
Connection data solid / stranded / AWG		
Dimensions	H / D	

Description	No. of pos.	Module width W
VARIOFACE module, with RJ45 plug-in connector		
With screw connection	8	26.90
With push-in connection	8	26.60

Modules with COMBICON connection

- The slim 10- and 18-pos. VARIOFACE SLIM-LINE modules connect the front connection terminal blocks to a COMBICON header. The corresponding COMBICON plugs (5.0 mm pitch) can be found in the COMBICON catalog PCB Connection Technique.
- The 32-pos. UMK-32 MDSTB/MKKDS 3/R module connects screw connection terminal blocks with coded COMBICON plug-in screw connectors.

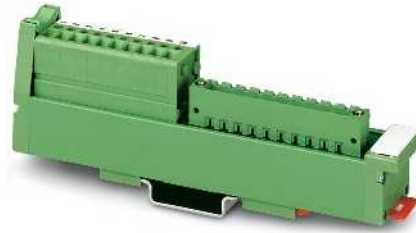

10- and 18-pos.
With screw connection

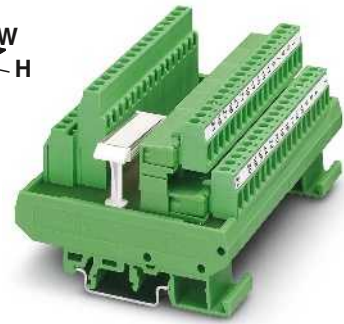

32-pos.
With screw connection

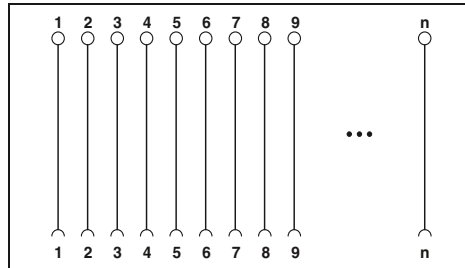

Technical data

250 V AC/DC
2.5 A
-10°C ... 50°C
Any
IEC 60664, DIN EN 50178, IEC 62103
45 mm / 25 mm

Ordering data

Type	Order No.	Pcs. / Pkt.
UM 25-10 MSTB/FRONT/Q	2959803	1
UM 25-18 MSTB/FRONT/Q	2959502	1

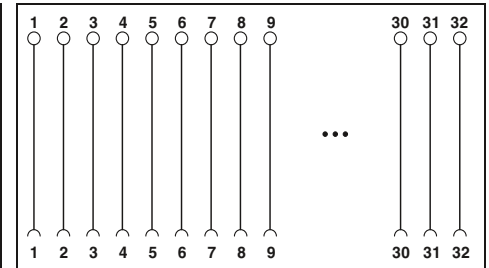

Technical data

250 V AC/DC
3 A
-20°C ... 50°C
Any
IEC 60664, DIN EN 50178, IEC 62103
58.5 mm / 112.5 mm

Ordering data

Type	Order No.	Pcs. / Pkt.
UMK-32 MDSTB/MKKDS3/R	2970196	1

Operating voltage
Max. perm. current (per branch)
Ambient temperature (operation)
Mounting position
Standards/regulations
Dimensions

D / W

Description	No. of pos.	Module height H
VARIOFACE-SLIM-LINE module, with a COMBICON header (without a COMBICON plug-in connector)	10 18	137.00 217.00
VARIOFACE module, with COMBICON plug-in connector, coded	32	77.00

VARIOFACE wiring interface

Modules as compact potential distributors

The VIP-2/.../PDM... modules offer the following features:

- Two potential levels
- Separate supply
- Screw or push-in connection
- Consecutive labeling

The UMK-PVB and UMK-PVB 6 modules have three or six potential levels.

Notes:

Marking systems and mounting material
See Catalog 5



With screw connection and 2 potential levels

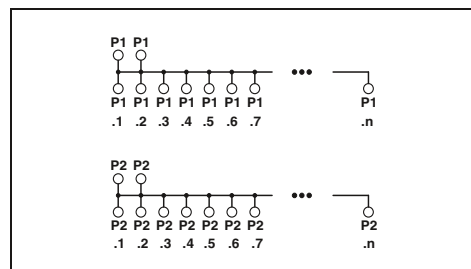

Technical data

Operating voltage	250 V AC/DC
Max. perm. current (per branch)	15 A
Total current	30 A (Per potential)
Ambient temperature (operation)	-20°C ... 50°C
Mounting position	Any
Standards/regulations	IEC 60664, DIN EN 50178, IEC 62103
Supply connection data solid / stranded / AWG	0.2 - 6 mm ² / 0.2 - 4 mm ² / 24 - 10
Distribution connection data solid / stranded / AWG	0.2 - 4 mm ² / 0.2 - 2.5 mm ² / 24 - 12
Dimensions	H / D 65.5 mm / 50 mm

Ordering data

Description	No. of pos.	Module width W	Type	Order No.	Pcs. / Pkt.
VARIOFACE module , with two busbars (P1, P2) for potential distribution, per potential:					
2 power terminal blocks/ 8 distributor terminal blocks		50.00	VIP-2/SC/PDM-2/16	2315256	1
2 power terminal blocks/ 12 distributor terminal blocks		70.40	VIP-2/SC/PDM-2/24	2315269	1
2 power terminal blocks/ 16 distributor terminal blocks		90.80	VIP-2/SC/PDM-2/32	2315272	1
2 power terminal blocks/ 24 distributor terminal blocks		131.50	VIP-2/SC/PDM-2/48	2903717	1
VARIOFACE module , with three busbars (+, -, PE) for potential distribution, per potential:					
(+) two power terminal blocks/48 distributor terminal blocks (-) two power terminal blocks/24 distributor terminal blocks (PE) 2 power/72 distributor terminal blocks		168.80			
VARIOFACE module , with six busbars (P1 to P6) for potential distribution, per potential:					
2 power terminal blocks/ 12 distributor terminal blocks		123.80			
VARIOFACE module , with two busbars (P1, P2) for potential distribution, per potential:					
2 power terminal blocks/ 8 distributor terminal blocks		41.90			
2 power terminal blocks/ 12 distributor terminal blocks		57.10			
2 power terminal blocks/ 16 distributor terminal blocks		67.30			
2 power terminal blocks/ 24 distributor terminal blocks		97.70			

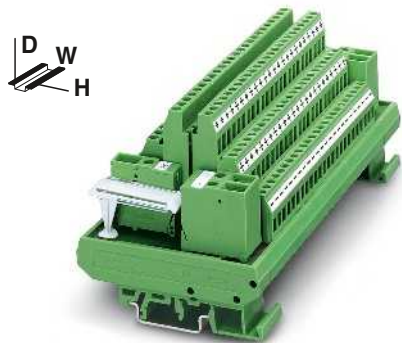

With screw connection and 3 potential levels

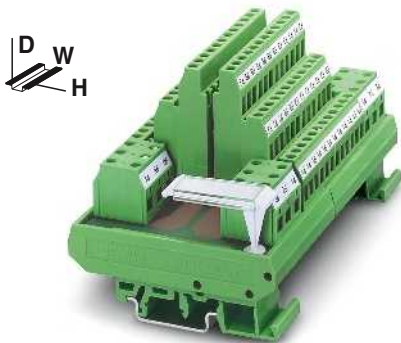

With screw connection and 6 potential levels

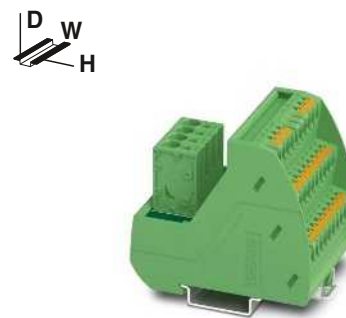

With push-in three-level connection and 2 potential levels

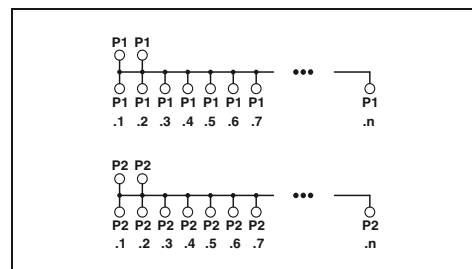
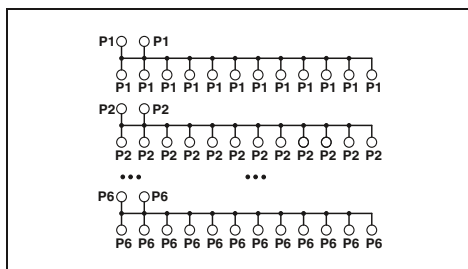
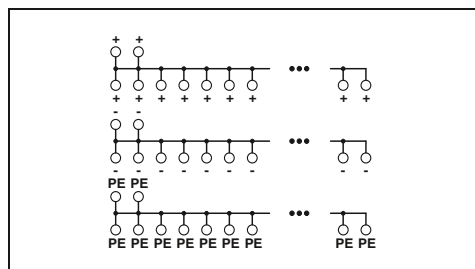

Technical data

250 V AC/DC
16 A
16 A (Per potential)
-20°C ... 50°C
Any
IEC 60664, DIN EN 50178, IEC 62103
0.5 - 6 mm² / 0.5 - 4 mm² / 20 - 10

0.2 - 4 mm² / 0.2 - 2.5 mm² / 24 - 12

77 mm / 72 mm

Technical data

250 V AC/DC
16 A
16 A (Per potential)
-20°C ... 50°C
Any
IEC 60664, DIN EN 50178, IEC 62103
0.2 - 6 mm² / 0.2 - 4 mm² / 24 - 10

0.2 - 4 mm² / 0.2 - 2.5 mm² / 24 - 12

77 mm / 72 mm

Technical data

250 V AC/DC
15 A
30 A (Per potential)
-20°C ... 50°C
Any
IEC 60664, DIN EN 50178, IEC 62103
0.25 - 6 mm² / 0.25 - 4 mm² / 24 - 10

0.14 - 2.5 mm² / 0.14 - 2.5 mm² / 26 - 14

75.8 mm / 63 mm

Ordering data

Type	Order No.	Pcs. / Pkt.
UMK- PVB	2971302	1

Ordering data

Type	Order No.	Pcs. / Pkt.
UMK- PVB 6	2972136	1

Ordering data

Type	Order No.	Pcs. / Pkt.
VIP-3/PT/PDM-2/16	2903797	1
VIP-3/PT/PDM-2/24	2903798	1
VIP-3/PT/PDM-2/32	2903799	1
VIP-3/PT/PDM-2/48	2903800	1

System cabling for controllers

VARIOFACE wiring interface

VARIOFACE modules for plug-in miniature relays and/or miniature solid-state relays

The UMK-... RM 4-, 8-, and 16-way relay or solid-state relay interfaces provide 4, 8 or 16 slots for standard electromechanical relays (REL-MR..., not REL-MR...MS) or optoelectronic relays (SIM-El...). The connections between the I/O module and the electronics, as well as the process cabling, are implemented via screw connection terminal blocks.

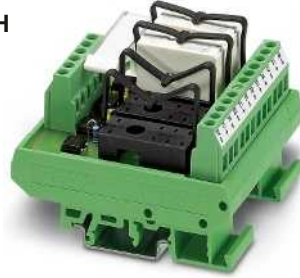

4-channel with bridge rectifier



4-channel for relays with a PDT contact

Notes:
For the protection of relay coils and contacts, inductive loads must be dampened with an efficient protection circuit.
Other input voltages on request.
1) not with 230 V AC.
2) with 230 V AC glow lamp.
3) with 100 V DC and 230 V AC glow lamp.

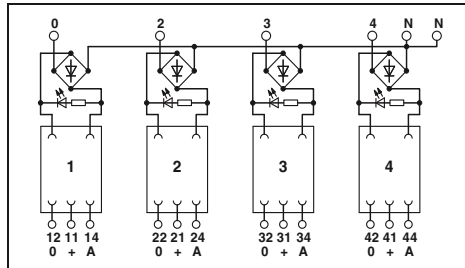

Technical data

Coil side	
Tolerance of the input voltage	±10%
Input circuit	Bridge rectifier
Operating voltage display	-
Status display/channel	Yellow LED
Connection method	Screw connection
Connection data solid / stranded / AWG	0.2 ... 4 mm ² / 0.2 ... 2.5 mm ² / 24 - 12
Contact side	
Contact type	1 PDT
Max. switching voltage	250 V AC/DC
Limiting continuous current	6 A
Connection method	Screw connection
Connection data solid / stranded / AWG	0.2 ... 4 mm ² / 0.2 ... 2.5 mm ² / 24 - 12
General data	
Test voltage	2.5 kV (50 Hz, 1 min.)
Ambient temperature (operation)	-20°C ... 50°C
Standards/regulations	DIN VDE 0110
Mounting position	Any
Dimensions	W / H / D 67.5 mm / 77 mm / 59 mm

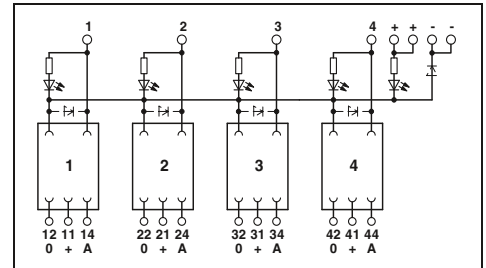

Technical data

Coil side	
Tolerance of the input voltage	±10%
Input circuit	Freewheeling diode, Protection against polarity reversal (Yellow LED ¹)
Operating voltage display	Yellow LED ²
Status display/channel	
Connection method	Screw connection
Connection data solid / stranded / AWG	0.2 ... 4 mm ² / 0.2 ... 2.5 mm ² / 24 - 12
Contact side	
Contact type	1 PDT
Max. switching voltage	250 V AC/DC
Limiting continuous current	5 A
Connection method	Screw connection
Connection data solid / stranded / AWG	0.2 ... 4 mm ² / 0.2 ... 2.5 mm ² / 24 - 12
General data	
Test voltage	2.5 kV (50 Hz, 1 min.)
Ambient temperature (operation)	-20°C ... 50°C
Standards/regulations	DIN VDE 0110
Mounting position	Any
Dimensions	W / H / D 67.5 mm / 77 mm / 59 mm

Ordering data

Description	Input voltage
VARIOFACE module, for four plug-in miniature relays or miniature solid-state relays, with light indicator (without relays)	24 V AC/DC
VARIOFACE module, for plug-in miniature relays or miniature solid-state relays, with light indicator (without relay)	5 V DC
	12 V DC
	24 V DC
	48 V DC
	110 V DC
	230 V AC

Type	Order No.	Pcs. / Pkt.
UMK- 4 RM 24	2971344	1

Ordering data

Type	Order No.	Pcs. / Pkt.
UMK- 4 RM 5DC	2972819	1
UMK- 4 RM 12DC	2972822	1
UMK- 4 RM 24DC	2972835	1
UMK- 4 RM 60DC	2972851	1
UMK- 4 RM110DC	2972864	1
UMK- 4 RM230AC	2972880	1

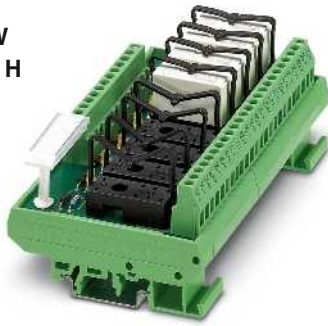

8-channel for relays with a PDT contact

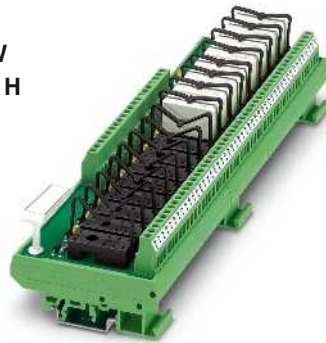

16-channel for relays with a PDT contact

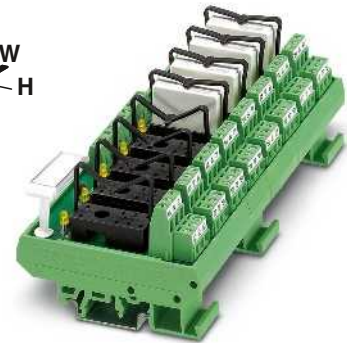

8-channel for relays with two PDT contacts

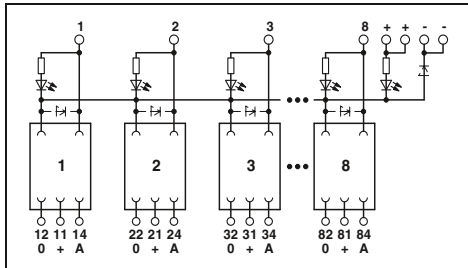

Technical data

±10%
 Freewheeling diode, Protection against polarity reversal
 Yellow LED²⁾
 Yellow LED³⁾

Screw connection
 0.2 ... 4 mm² / 0.2 ... 2.5 mm² / 24 - 24

1 PDT
 250 V AC
 5 A
 Screw connection
 0.2 ... 4 mm² / 0.2 ... 2.5 mm² / 24 - 12

2.5 kV (50 Hz, 1 min.)
 -20°C ... 50°C
 DIN VDE 0110
 Any
 135 mm / 77 mm / 59 mm

Ordering data

Type	Order No.	Pcs. / Pkt.
UMK- 8 RM 5DC/MKDS	2972893	1
UMK- 8 RM 12DC/MKDS	2972903	1
UMK- 8 RM24DC/MKDS	2972916	1
UMK- 8 RM 60DC/MKDS	2972932	1
UMK- 8 RM110DC/MKDS	2972945	1
UMK- 8 RM230AC/MKDS	2972961	1

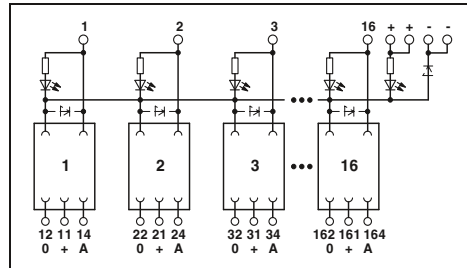

Technical data

±10%
 Freewheeling diode, Protection against polarity reversal
 Yellow LED²⁾
 Yellow LED³⁾

Screw connection
 0.2 ... 4 mm² / 0.2 ... 2.5 mm² / 24 - 24

1 PDT
 250 V AC
 5 A
 Screw connection
 0.2 ... 4 mm² / 0.2 ... 2.5 mm² / 24 - 12

2.5 kV (50 Hz, 1 min.)
 -20°C ... 50°C
 DIN VDE 0110
 Any
 259 mm / 77 mm / 59 mm

Ordering data

Type	Order No.	Pcs. / Pkt.
UMK-16 RM 5DC/MKDS	2972974	1
UMK-16 RM 12DC/MKDS	2972987	1
UMK-16 RM 24DC/MKDS	2972990	1
UMK-16 RM 60DC/MKDS	2973038	1
UMK-16 RM110DC/MKDS	2973041	1
UMK-16 RM230AC/MKDS	2973067	1

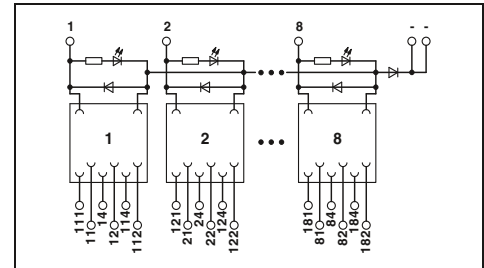

Technical data

±10%
 Freewheeling diode, Protection against polarity reversal
 -
 Yellow LED

Screw connection
 0.14 ... 1.5 mm² / 0.14 ... 1.5 mm² / 26 - 26

2 PDT
 250 V AC
 5 A
 Screw connection
 0.14 ... 1.5 mm² / 0.14 ... 1.5 mm² / 26 - 14

2.5 kV (50 Hz, 1 min.)
 -20°C ... 50°C
 DIN VDE 0110
 Any
 168.8 mm / 77 mm / 59 mm

Ordering data

Type	Order No.	Pcs. / Pkt.
UMK- 8 RELS/KSR-24/21/21	2975722	1

System cabling for controllers

VARIOFACE wiring interface

VARIOFACE modules as interface for plug-in solid-state relays or digital I/O modules

The 1-, 4-, 8- or 16-time INTERFACE modules are the wiring interface and the coupling level in one unit. The connection to the interface module is established using screw connection technology.

Properties of the single interface:

- Status display
- Protection against polarity reversal in input
- Surge protection in input
- Assembly option with solid-state relay for loads up to 350 V DC/1 A or 480 V AC/5 A

Properties of the 4-, 8-, and 16-time interfaces:

- Status display
- Integrated fuse for line protection
- Assembly option with solid-state relay or I/O modules

Notes:
Type of housing: Polyamide PA non-reinforced, color: green.
Marking systems and mounting material See Catalog 5
For the protection of relay coils and contacts, inductive loads must be dampened with an efficient protection circuit.
Solid-state relays, see page 558

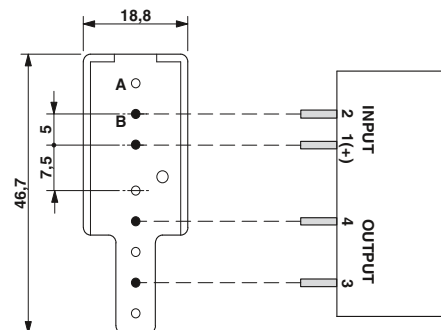

A = without metal
B = with metal

Input data
Input voltage range
Input circuit
Status display/channel
Connection method
Connection data solid / stranded / AWG
Output data
Connection method
Connection data solid / stranded / AWG
General data
Ambient temperature (operation)
Standards/regulations
Mounting position
Mounting
Dimensions

H / D

Description	Module width W
Interface module , with plug-in base for one solid-state relay, with locking clip	22.5
Interface module , with plug-in base for four solid-state relays, with locking clip Microfuse: 250 V, 4 A	90
Interface module , with plug-in base for eight digital I/O modules. Microfuse: 250 V, 4 A	180
Interface module , with plug-in base for eight solid-state relays, with locking clip Microfuse: 250 V, 4 A	180
Interface module , with plug-in base for 16 digital I/O modules. Microfuse: 250 V, 4 A	326.5
Interface module , with plug-in base for 16 solid-state relays, with locking clip Microfuse: 250 V, 4 A	326.5

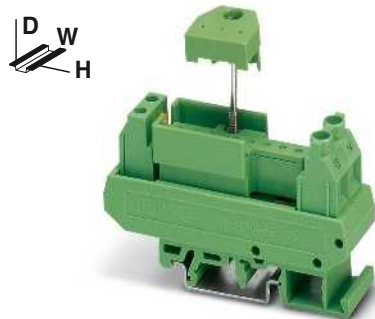

With light indicator

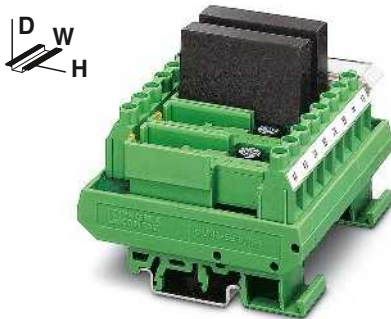

With light indicator and fuse,
control logic negative switching

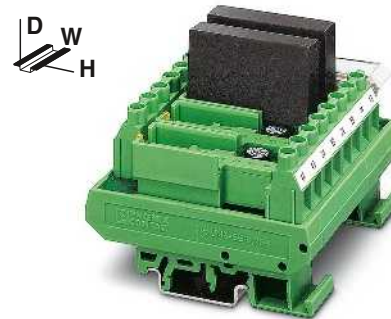

With light indicator and fuse,
control logic positive switching

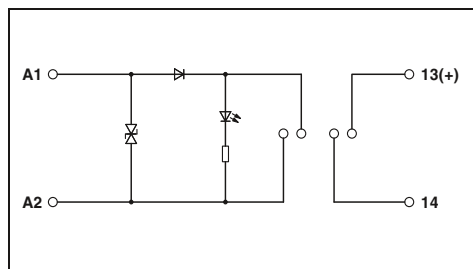
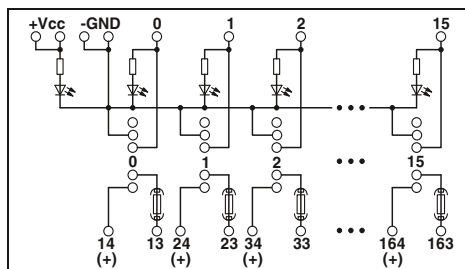
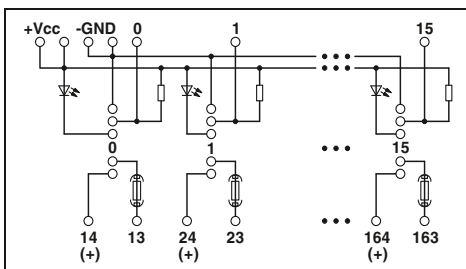

Technical data

4 V ... 32 V
Protection against polarity reversal, Surge protection
Yellow LED
Screw connection
0.2 ... 4 mm² / 0.2 ... 2.5 mm² / 24 - 12
Screw connection
0.2 ... 6 mm² / 0.2 ... 4 mm² / 24 - 10

-20°C ... 60°C
DIN EN 50178

Any
In rows with zero spacing
77 mm / 72 mm

Technical data

4 V ... 32 V
Yellow LED
Screw connection
0.2 ... 4 mm² / 0.2 ... 2.5 mm² / 24 - 24
Screw connection
0.2 ... 6 mm² / 0.2 ... 4 mm² / 24 - 10

-20°C ... 55°C
DIN VDE 0110b, Gr. C for 250 V DC, DIN VDE 0160
(in relevant parts)

Any
In rows with zero spacing
77 mm / 72 mm

Technical data

4 V ... 32 V
Yellow LED
Screw connection
0.2 ... 4 mm² / 0.2 ... 2.5 mm² / 24 - 24
Screw connection
0.2 ... 6 mm² / 0.2 ... 4 mm² / 24 - 10

-20°C ... 55°C
DIN VDE 0110b, Gr. C for 250 V DC, DIN VDE 0160
(in relevant parts)

Any
In rows with zero spacing
77 mm / 72 mm

Ordering data

Type	Order No.	Pcs. / Pkt.
UMK- 1 OM-R/AMS	2983002	1

Ordering data

Type	Order No.	Pcs. / Pkt.
UMK- 4 OM-R/MF	2970882	1
UMK- 8 OM/MF/MKDS	2972712	1
UMK- 8 OM-R/MF/MKDS	2972738	1
UMK-16 OM/MF/MKDS	2972754	1
UMK-16 OM-R/MF/MKDS	2972770	1

Ordering data

Type	Order No.	Pcs. / Pkt.
UMK- 4 OM-R/MF/P	2972673	1
UMK- 8 OM-R/MF/MKDS/P	2972699	1
UMK-16 OM-R/MF/MKDS/P	2972796	1

REL-MR miniature relay

The robust relays are used as interface relays throughout process and production engineering.

The main features of these relays are their compact design, reliable electrical isolation, and compliance with the most important standards, as well as the number of variants.

Notes:
If the specified maximum values for multi-layer contact relays are exceeded, the gold plating is destroyed. The maximum values of the power contact relay are then valid. This can result in a shorter service life than with a pure power contact.
For diagrams of operating voltage ranges, see page 344



1 N/O contact

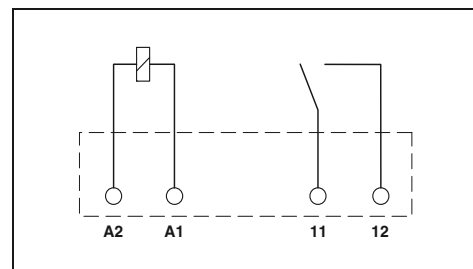

Input data	
Permissible range (with reference to U_N)	-
Permissible range (with reference to U_N)	0.8 - 1.1
Typ. input current at U_N	[mA] 5
Typ. response time at U_N	[ms] 5
Typ. response time at U_N (depending on phase relation)	[ms]
Typ. release time at U_N	[ms] 2
Typ. release time at U_N (depending on phase relation)	[ms]
Output data	
Contact type	Double contact, 1 N/O contact
Contact material	AgNi, hard gold-plated
Max. switching voltage	250 V AC / 125 V DC
Min. switching voltage	5 V DC
Limiting continuous current	3 A
Max. inrush current	5 A
Max. interrupting rating, ohmic load	250 V AC
General data	
Test voltage (winding / contact)	2 kV AC (50 Hz, 1 min.)
Test voltage (contact/contact)	-
Ambient temperature (operation)	-40°C ... 85°C
Nominal operating mode	100% operating factor
Mechanical service life	Approx. 2×10^7 cycles
Standards/regulations	DIN VDE 0110, IEC 255/DIN VDE 0435 (in relevant parts)
Mounting position/mounting	Any
Dimensions	W / H / D 5 mm / 23 mm / 17 mm

Technical data

Ordering data		
Type	Order No.	Pcs. / Pkt.
REL-MR-G 24/1	2961037	8

Description	Input voltage U_N
Plug-in miniature power relays	
with power contact	① 12 V DC
with power contact	② 24 V DC
with power contact	③ 48 V DC
with power contact	④ 60 V DC
with power contact	⑤ 110 V DC
with power contact	⑥ 230 V AC
Plug-in miniature power relays	
with gold contact	① 12 V DC
with gold contact	② 24 V DC
with gold contact	③ 48 V DC
with gold contact	④ 60 V DC
with gold contact	⑤ 110 V DC
with gold contact	⑥ 230 V AC



1 PDT for high continuous currents



2 PDT

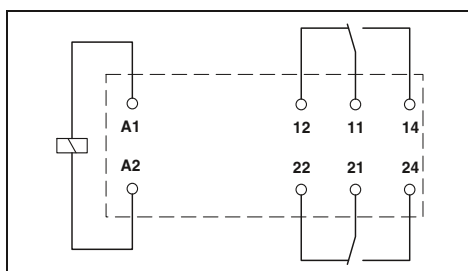
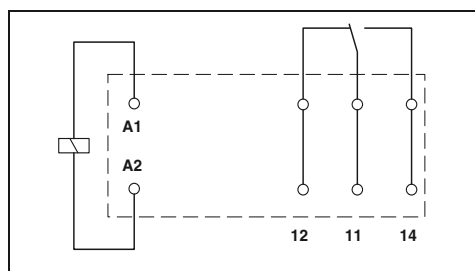

Technical data

Technical data

① ② ③ ④ ⑤ ⑥
refer to the diagram

① ② ③ ④ ⑤ ⑥
refer to the diagram

33	17	8.7	8.2	4.1	3
7	7	7	7	7	
					3 - 12
3	3	3	3	3	
					2 - 9

33	17	8.7	8.2	4.1	3
7	7	7	7	7	
					3 - 12
3	3	3	3	3	
					2 - 9

Single contact, 1-PDT

Single contact, 1-PDT

Single contact, 2-PDT

Single contact, 2-PDT

AgNi
250 V AC/DC
12 V (at 10 mA)
16 A
30 A (300 ms)

AgNi, hard gold-plated
30 V AC / 36 V DC
100 mV (at 10 mA)
50 mA
50 mA

AgNi
250 V AC/DC
5 V (at 10 mA)
8 A
25 A (20 ms)

AgNi, hard gold-plated
30 V AC / 36 V DC
100 mV (at 10 mA)
50 mA
50 mA

4000 VA

-

2000 VA

-

5 kV AC (50 Hz, 1 min.)

-

5 kV AC (50 Hz, 1 min.)

2.5 kV AC (50 Hz, 1 min.)

-40°C ... 85°C

-40°C ... 85°C

100% operating factor

100% operating factor

3 x 10⁷ cycles

3 x 10⁷ cycles

IEC 60664, EN 50178, IEC 62103

IEC 60664, EN 50178, IEC 62103

Any / Can be aligned without spacing (> 70°C ≥ 2.5 mm)

Any / Can be aligned without spacing (> 70°C ≥ 2.5 mm)

12.7 mm / 29 mm / 15.7 mm

12.7 mm / 29 mm / 15.7 mm

Ordering data

Ordering data

Type	Order No.	Pcs. / Pkt.
REL-MR- 12DC/21HC	2961309	10
REL-MR- 24DC/21HC	2961312	10
REL-MR- 48DC/21HC	2834821	10
REL-MR- 60DC/21HC	2961325	10
REL-MR-110DC/21HC	2961338	10
REL-MR-230AC/21HC	2961422	10
REL-MR- 12DC/21HC AU	2961532	10
REL-MR- 24DC/21HC AU	2961545	10
REL-MR-110DC/21HC AU	2961561	10
REL-MR-230AC/21HC AU	2961529	10

Type	Order No.	Pcs. / Pkt.
REL-MR- 12DC/21-21	2961257	10
REL-MR- 24DC/21-21	2961192	10
REL-MR- 48DC/21-21	2834834	10
REL-MR- 60DC/21-21	2961273	10
REL-MR-110DC/21-21	2961202	10
REL-MR-230AC/21-21	2961451	10
REL-MR- 12DC/21-21AU	2961299	10
REL-MR- 24DC/21-21AU	2961215	10
REL-MR- 48DC/21-21AU	2834847	10
REL-MR- 60DC/21-21AU	2961286	10
REL-MR-110DC/21-21AU	2961228	10
REL-MR-230AC/21-21AU	2961480	10

SIM-EI miniature solid-state relay

The SIM-EI miniature solid-state relays have connections compatible with commercially available miniature switching relays and are of the same shape.

The modules are used for floating conditioning of process signals as an alternative to electromechanical relays. Substituting mechanical relays for solid-state ones opens new possibilities for solving interface problems in a user-friendly way. The compatibility of the pins with the mechanical relay permits use of solid-state relays without any changes in the layout. The output of the solid-state relay is "high active" and designed as a 2- or 3-conductor output.



with DC voltage output
max. = 100 mA

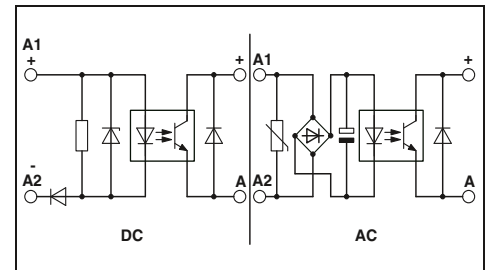

Technical data

Input data		①	②	③	④	⑤	⑥	⑦	⑧	
Permissible range (with reference to U_N)		0.9 - 1.1	0.9 - 1.1	0.9 - 1.1	0.9 - 1.1	0.9 - 1.1	0.9 - 1.1	0.9 - 1.1	0.9 - 1.1	
Switching level with reference to U_N	1 signal ("H")	≥ 0.8	≥ 0.8	≥ 0.8	≥ 0.8	≥ 0.8	≥ 0.8	≥ 0.8	≥ 0.8	
	0 signal ("L")	≤ 0.35	≤ 0.4	≤ 0.4	≤ 0.25	≤ 0.4	≤ 0.4	≤ 0.4	≤ 0.4	
Typ. input current at U_N	[mA]	5.4	5.7	5.1	6.8	2.4	2.6	2.1	2.1	
Transmission frequency f_{limit}	[Hz]	600	600	600	600	300	300	3	3	
Input circuit AC		Protection against polarity reversal, Surge protection								
Input circuit DC		Protection against polarity reversal								
Output data		8 V DC ... 48 V DC								
Operating voltage range		100 mA								
Limiting continuous current		1 V								
Residual voltage drop at "H"		-								
Max. inrush current		2-conductor, floating								
Output circuit		Protection against polarity reversal								
Output protection		2.5 kV (50 Hz, 1 min.)								
General data		-20°C ... 50°C								
Test voltage input/output		DIN VDE 0110								
Ambient temperature (operation)		Any / Can be aligned with 2 mm spacing								
Standards/regulations		13 mm / 29 mm / 25 mm								
Mounting position/mounting										
Dimensions	W / H / D									

Ordering data

Description	Input voltage U_N	Type	Order No.	Pcs. / Pkt.
Solid-state relay , with protective circuit in the input and output circuit				
	① 5 V DC	SIM-EI- 5DC/48DC/100	2271057	10
	② 12 V DC	SIM-EI- 12DC/48DC/100	2271060	10
	③ 24 V DC	SIM-EI- 24DC/48DC/100	2271073	10
48 V DC ... 60 V DC	④ 60 V DC	SIM-EI- 60DC/48DC/100	2271086	10
	⑤ 110 V DC	SIM-EI-110DC/48DC/100	2271099	10
	⑥ 220 V DC	SIM-EI-220DC/48DC/100	2271109	10
	⑦ 120 V AC	SIM-EI-120AC/48DC/100	2271112	10
	⑧ 230 V AC	SIM-EI-230AC/48DC/100	2271125	10

Accessories

Accessories	Order No.	Pcs. / Pkt.
Plug-in base , for plug-in miniature relays or miniature solid-state relays, for soldering onto the printed circuit board.		
Retaining bracket , for miniature solid-state relay		
- Plastic	2271484	100
- Metal		
Retaining bracket , for miniature relay		
- Plastic	2271468	10
- Metal	2271497	10
	2271471	10
	2271510	10

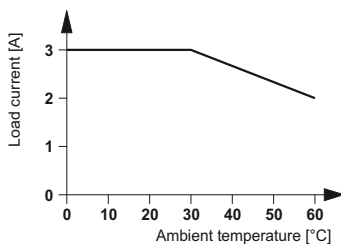

Derating curve for SIM-EI-OV-24 DC/24 DC/3



with TTL logic level output,
max. = 100 mA



with DC voltage output
Maximum = 100 mA, RC element in input



with DC voltage output
max. = 3 A

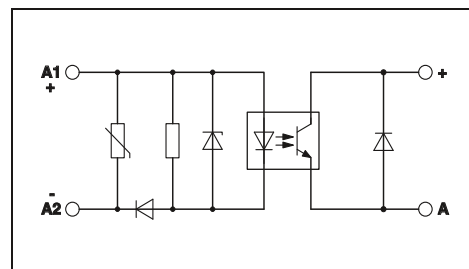
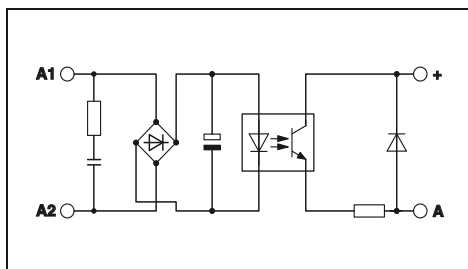
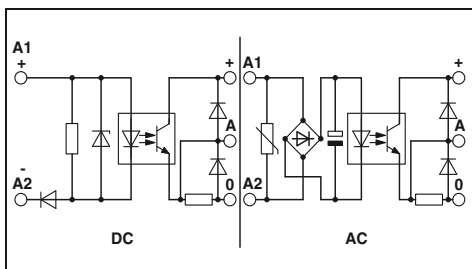

Technical data

①	②	③	④	⑤	⑥	⑦	⑧
0.9 - 1.1	0.9 - 1.1	0.9 - 1.1	0.9 - 1.1	0.9 - 1.1	0.9 - 1.1	0.9 - 1.1	0.9 - 1.1
≥ 0.8	≥ 0.8	≥ 0.8	≥ 0.8	≥ 0.8	≥ 0.8	≥ 0.8	≥ 0.8
≤ 0.35	≤ 0.4	≤ 0.4	≤ 0.25	≤ 0.4	≤ 0.4	≤ 0.4	≤ 0.4
5.4	5.7	5.1	4.7	2.4	2.6	2.1	2.1
4000	4000	4000	4000	1000	1000	3	3

Protection against polarity reversal, Surge protection
Protection against polarity reversal

3 V DC ... 5.25 V DC
100 mA
0.3 V

-
3-conductor, ground-referenced
Protection against polarity reversal, Free running

2.5 kV (50 Hz, 1 min.)
-20°C ... 50°C
DIN VDE 0110
Any / Can be aligned with 2 mm spacing
13 mm / 29 mm / 25 mm

Technical data

⑦	⑧
0.9 - 1.1	0.9 - 1.1
≥ 0.8	≥ 0.8
≤ 0.4	≤ 0.4
2.2	2.5
3	3

RC element

8 V DC ... 48 V DC
100 mA
1 V

-
2-conductor, floating
Protection against polarity reversal

2.5 kV (50 Hz, 1 min.)
-20°C ... 50°C
DIN VDE 0110
Any / Can be aligned with 2 mm spacing
13 mm / 29 mm / 25 mm

Technical data

③
0.8 - 1.2
≥ 0.8
≤ 0.4
7
300

Protection against polarity reversal, Surge protection

3 V DC ... 33 V DC
3 A (see derating curve)
≤ 200 mV

15 A (10 ms)
2-conductor, floating
Protection against polarity reversal, Surge protection

2.5 kV (50 Hz, 1 min.)
-20°C ... 60°C
DIN VDE 0110
Any / Can be aligned with 2 mm spacing
13 mm / 29 mm / 25 mm

Ordering data

Type	Order No.	Pcs. / Pkt.
SIM-EI- 5DC/TTL/100	2271138	10
SIM-EI- 12DC/TTL/100	2271141	10
SIM-EI- 24DC/TTL/100	2271154	10
SIM-EI- 60DC/TTL/100	2271167	10
SIM-EI-110DC/TTL/100	2271170	10
SIM-EI-220DC/TTL/100	2271183	10
SIM-EI-120AC/TTL/100	2271196	10
SIM-EI-230AC/TTL/100	2271206	10

Ordering data

Type	Order No.	Pcs. / Pkt.
SIM-EI-120AC/48DC/100/RC	2271439	10
SIM-EI-230AC/48DC/100/RC	2271426	10

Ordering data

Type	Order No.	Pcs. / Pkt.
SIM-EI-OV- 24DC/ 24DC/3	2300096	10

Accessories

Type	Order No.	Pcs. / Pkt.
SIM-ERSN	2271484	100
SIM-ERSN-HB-KSR	2271468	10
SIM-ERSN-HB-KSR/MET	2271497	10
SIM-ERSN-HB-MR	2271471	10
SIM-ERSN-HB-MR/MET	2271510	10

Accessories

Type	Order No.	Pcs. / Pkt.
SIM-ERSN	2271484	100
SIM-ERSN-HB-KSR	2271468	10
SIM-ERSN-HB-KSR/MET	2271497	10
SIM-ERSN-HB-MR	2271471	10
SIM-ERSN-HB-MR/MET	2271510	10

Accessories

Type	Order No.	Pcs. / Pkt.
SIM-ERSN	2271484	100
SIM-ERSN-HB-KSR	2271468	10
SIM-ERSN-HB-KSR/MET	2271497	10
SIM-ERSN-HB-MR	2271471	10
SIM-ERSN-HB-MR/MET	2271510	10

OV solid-state relay

Solid-state relays for electrical isolation can be mounted directly on the printed circuit board as interfaces or plugged in using the SIM-AMS solder-in socket.

The solid-state relays are suitable for switching ohmic, capacitive or inductive loads. Relays for switching AC circuits have a zero voltage switch to switch the load on in the zero voltage crossing. It is switched off in the zero current crossing. The integrated RC element permits operation up to $\cos \phi = 0.5$.

Inductive DC loads must be equipped with a fast-acting freewheeling diode for semiconductor relay protection.

- Switching capacity up to 350 V DC/1 A, 60 V DC/4 A or 480 V AC/5 A
- No wear and tear even with high switching frequencies
- No contact bounce – no movable parts
- No electromagnetic interference
- Electrically insulated housings
- Small dimensions
- High test voltage of 4 kV between control and load circuits

Notes:
For derating curves see page 564
For suitable bases, see page 560
¹⁾ Turn-on/off time at U_N : Max. ½ period



with DC voltage output
max. = 1 A

RLIS

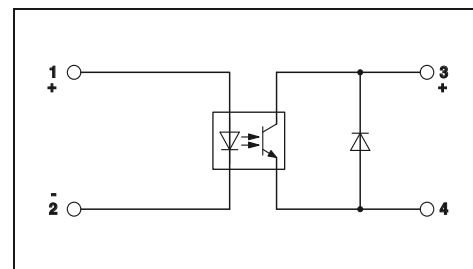

Technical data

Input data	①
Input voltage range	4.25 V DC ... 32 V DC
Switching level	3.3
	1 signal ("H") [V DC] ≥
	0 signal ("L") [V DC] ≤
Typ. input current at U_N	[mA] 15
Typ. switch-on time at U_N	[µs] 100
Typ. switch-off time at U_N	[µs] 250
Transmission frequency f_{limit}	[Hz] 100
Output data	
Operating voltage range	1 V DC ... 350 V DC
Periodic peak reverse voltage	-
Limiting continuous current	1 A (see derating curve)
Min. load current	1 mA
Surge current	20 A (tp = 1 s)
Residual voltage drop at "H"	0.5 V
Leakage current in off state	100 µA
Phase angle (cos φ)	-
Max. load value	-
Output protection	Protection against polarity reversal
General data	
Test voltage input/output	4 kV (50 Hz, 1 min.)
Ambient temperature (operation)	-20°C ... 80°C
Standards/regulations	EN 61000-4-2, EN 61000-4-3, EN 61000-4-4, EN 55011
Mounting position/mounting	Any / Can be aligned with > 9 mm spacing
Dimensions	10.5 mm / 43 mm / 25.4 mm

Ordering data

Description	Input voltage U_N	Type	Order No.	Pcs. / Pkt.
Solid-state relay for signal amplification and electrical isolation of the control and load circuits, can be plugged into the solder-in plug-in base SIM-AMS or with PCB connection for direct mounting onto the PCB. Input: DC voltage Output: DC voltage	① 24 V DC			
Solid-state relay , same as before, however Input: DC voltage Output: AC voltage	① 24 V DC			
		OV-24DC/350DC/1	2982634	10



with DC voltage output
max. = 4 A



with AC voltage output
max. = 5 A

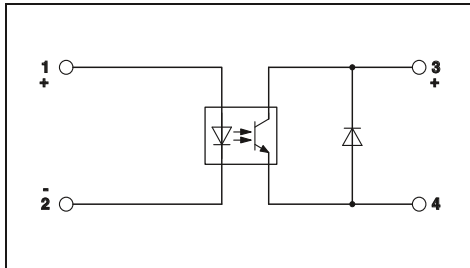

Technical data

①
4.25 V DC ... 32 V DC
3.3
1
15
100
250
100

1 V DC ... 60 V DC
-
4 A (see derating curve)
1 mA
25 A (tp = 1 s)
0.5 V
100 μ A
-
-
Protection against polarity reversal

4 kV (50 Hz, 1 min.)
-20°C ... 80°C
EN 61000-4-2, EN 61000-4-3, EN 61000-4-4, EN 55011

Any / Can be aligned with > 20 mm spacing
10.5 mm / 43 mm / 25.4 mm

Ordering data

Type	Order No.	Pcs. / Pkt.
OV-24DC/ 60DC/4	2982647	10

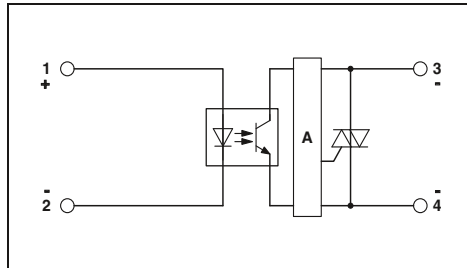

Technical data

①
4 V DC ... 32 V DC
3.5
1.2
10
25

12 V AC ... 530 V AC (45/65 Hz)
1000 V
5 A (see derating curve)
20 mA
80 A (tp = 20 ms)
1.2 V
< 1 mA
0.5
50 A²s
-

4 kV (50 Hz, 1 min.)
-20°C ... 70°C
EN 61000-4-2, EN 61000-4-3, EN 61000-4-4, EN 61000-4-5,
EN 61000-4-6

Any / Can be aligned with > 20 mm spacing
10.5 mm / 43 mm / 25.4 mm

Ordering data

Type	Order No.	Pcs. / Pkt.
OV-24DC/480AC/5	2982650	10

Solder-in socket for solid-state relays and I/O modules

Modern interface solutions for computer and electronic controls are increasingly being designed as I/O systems which are system-independent and individually mountable. Electrical isolation and signal conditioning are carried out using standard I/O modules. These are produced by various manufacturers in pin-compatible versions for different functions. The I/O modules are either soldered directly into the PCB or plugged into component sockets for quick interchanging.

SIM sockets facilitate the plugging of I/O modules considerably. All standard I/O modules and solid-state relays with up to eight connections can be plugged into the solder-in plug-in socket.

The I/O modules are securely fixed to the socket using fastening screws which are specific to the module. They are thereby protected against being accidentally released. Optocouplers, now also available in plug-in versions, are secured using the latch which is attached to the socket and which can be labeled. For better identification, each module plug position has its own marking panel on the socket.

The SIM socket has been designed so that it can be used on existing printed circuit boards without any layout modifications. Peripheral components such as LEDs or fuse resistors remain accessible to the user.

Notes:
Type of housing: Polyamide PA non-reinforced, color: green.
Marking systems and mounting material See Catalog 5
For dimensional drawings and pin assignments, see page 564
¹⁾ Applies only to the sockets SIM-AMS 1, SIM-AMS 1-R and SIM-AMSC in connection with the standard I/O modules with the corresponding AC voltage output.

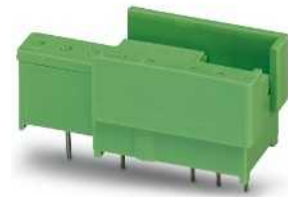

Plug-in base for solid-state relays

Operating voltage

Nominal current
Standards/regulations



Technical data

250 V AC / 380 V AC¹⁾

5 A
DIN VDE 0110b, Gr. C for 250 V DC

Ordering data

Description	No. of pos.	Module width W
Plug-in base , for solid-state relay and I/O modules, with different numbers of contacts, can be labeled with marker pins BN or BNB		
Partial assembly Complete assembly		
Plug-in base , as above, however, with locking clips for fastening		
Partial assembly Complete assembly		
Plug-in base , for standard I/O modules of generation 4 of the company Opto 22, can be labeled using marker pins BN or BNB		

Type	Order No.	Pcs. / Pkt.
SIM-AMS 1	2271015	10
SIM-AMS 2	2271028	10

Marker pin , made of white plastic, lettering area 7.5 x 4 mm, unprinted for self-marking with B-STIFT
Marker pen, not refillable , for manual labeling, line thickness 0.5 mm

Accessories

BN-TRK	2701404	100
B-STIFT	1051993	10

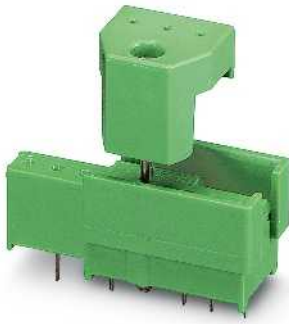

Plug-in base for solid-state relays with locking clip

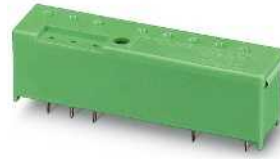

Plug-in base for I/O modules



Technical data

250 V AC / 380 V AC¹⁾

5 A
DIN VDE 0110b, Gr. C for 250 V DC

Ordering data

Type	Order No.	Pcs. / Pkt.
SIM-AMS 1-R	2271031	10
SIM-AMS 2-R	2271044	10

Accessories

BN-TRK	2701404	100
B-STIFT	1051993	10

Technical data

250 V AC / 380 V AC¹⁾

5 A
DIN VDE 0110b, Gr. C for 250 V DC

Ordering data

Type	Order No.	Pcs. / Pkt.
SIM-AMSC1	2271390	50

Accessories

BN-TRK	2701404	100
B-STIFT	1051993	10

System cabling for controllers

VARIOFACE wiring interface

Modules for IEC 60603/DIN 41612 plug-in connectors

Cable housing suitable for snap-lock mechanism:

Manufacturer	Type F 32- and 48-pos.	
HARTING	Types "B" and "D"	

Cable housing suitable for screw locking:

Manufacturer	Type C, 64-pos.	Type D, 32-pos.
ERNI	KSG 173...	KSG 173...
AMP	826196-1	826196-1

Cable housing suitable for screw locking:

Manufacturer	Type E, 48-pos.	Type F, 32- and 48-pos.
ERNI	KSG 173...	KSG 203...
AMP	-	826198-1

Modules for ELCO plug-in connectors

Dimensional drawing for UMK-EC38/38-XOL

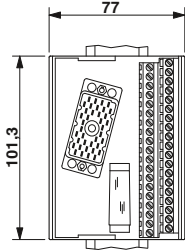

Dimensional drawing for UMK-EC38/38-XOR

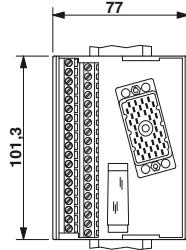

Dimensional drawing for UMK-EC56/56-XOL

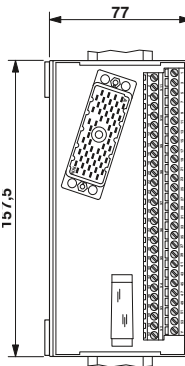

Dimensional drawing for UMK-EC56/56-XOR

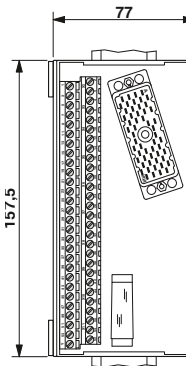

Dimensional drawing for UMK-EC56/Front 2,5V/R

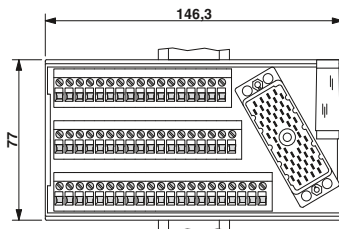

Dimensional drawing for UMK-EC56/Front 2,5V/L

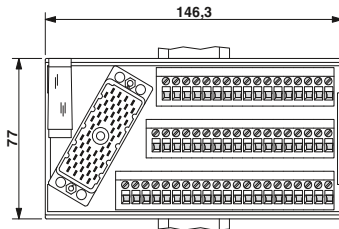

Dimensional drawing for UMK-EC56/32-XOL

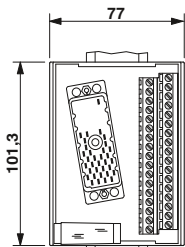

Dimensional drawing for UMK-EC56/32-XOR

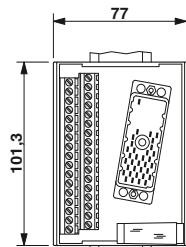

Pin assignment UMK-EC38/38...

Terminal block	Pin strip
1	A
2	B
3	C
4	D
5	E
6	F
7	H
8	J
9	K
10	L
11	M
12	N
13	P
14	R
15	S
16	T
17	U
18	V
19	W
20	X
21	Y
22	Z
23	AA
24	BB
25	DD
26	EE
27	FF
28	HH
29	JJ
30	KK
31	LL
32	MM
33	NN
34	PP
35	RR
36	SS
37	TT
CC	CC

Pin assignment UMK-EC56/56...

Terminal block	Pin strip
Z	Z
1	A
2	B
3	C
4	D
5	E
6	F
7	H
8	J
9	K
10	L
11	M
12	N
13	P
14	R
15	S
16	T
17	U
18	V
19	W
20	X
21	a
22	b
23	c
24	d
25	e
26	f
27	h
28	j
29	k
30	l
31	m
32	n
33	p
34	r
35	s
36	t
37	u
38	v
39	w
40	x
41	y
42	z
43	AA
44	BB
45	CC
46	DD
47	EE
48	FF
49	HH
50	JJ
51	KK
52	LL
53	MM
54	NN
Y	Y (shield)

Modules for ELCO plug-in connectors with protection type Ex i

Pin assignment UMK-EC56/Front 2,5V/...

Terminal block	ELCO plug
X	N.C.
1	A
2	B
3	C
4	D
5	E
6	F
7	H
8	J
9	K
10	L
11	M
12	N
13	P
14	R
15	S
16	T
17	U
18	V
19	W
20	X
21	a
22	b
23	c
24	d
25	e
26	f
27	h
28	j
29	k
30	l
31	m
32	n
33	p
34	r
35	s
36	t
37	u
38	v
39	w
40	x
41	y
42	z
43	AA
44	BB
45	CC
46	DD
47	EE
48	FF
49	HH
50	JJ
51	KK
52	LL
53	MM
54	NN
Y	Y (shield)

Pin assignment UMK-EC56/32-...

Terminal block	ELCO plug
1	A
2	B
3	C
4	D
5	E
6	F
7	H
8	J
9	K
10	L
11	M
12	N
13	P
14	R
15	S
16	T
17	U
18	V
19	W
20	X
21	Z
22	a
23	b
24	c
25	d
26	e
27	f
28	h
29	j
30	k
31	l
32	m
Y	NN + Y

Dimensional drawing for UMK-EC90/32/EX-XUL

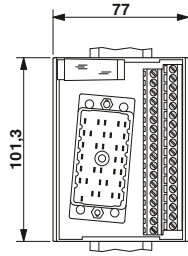

Dimensional drawing for UMK-EC90/32/EX-XUR

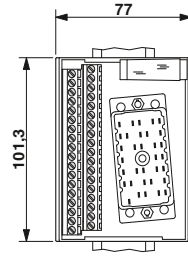

Dimensional drawing for UMK-EC56/25/EX-L

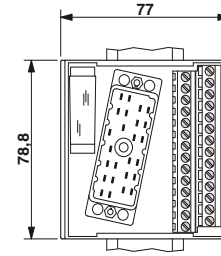

Dimensional drawing for UMK-EC56/25/EX-R

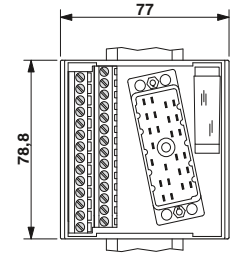

Dimensional drawing for UMK-EC90/32/EX-XOL

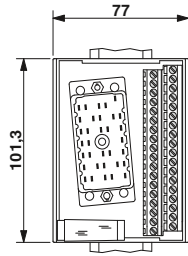

Dimensional drawing for UMK-EC90/32/EX-XOR

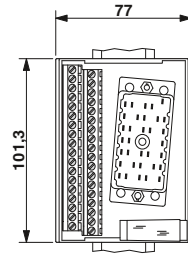

Dimensional drawing for UMK-EC 56/25/EX/Front 2,5 V/L

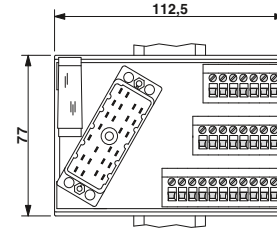

Dimensional drawing for UMK-EC 56/25/EX/Front 2,5 V/R

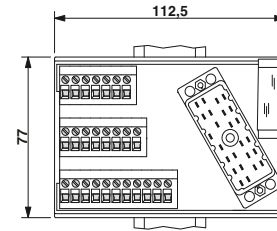

Pin assignment UMK-EC90/32/EX-...

Terminal block	Pin strip	Channel
1	H	
2	J	1
3	L	
4	M	2
5	P	
6	X	3
7	Z	
8	AA	4
9	AC	
10	AD	5
11	AM	
12	AN	6
13	AR	
14	AS	7
15	AU	
16	BC	8
17	AZ	
18	BA	9
19	BJ	
20	BK	10
21	BM	
22	BN	11
23	BR	
24	BY	12
25	CA	
26	CB	13
27	CD	
28	CE	14
29	CN	
30	CP	15
31	CS	
32	CT	16
Y	DS	

Pin assignment UMK-EC 56/25/EX-...

Terminal block	Pin strip	Channel
1	C	
2	D	1
3	E	
4	F	2
5	N	
6	P	3
7	R	
8	S	4
9	a	
10	b	5
11	d	
12	j	6
13	k	
14	l	7
15	s	
16	t	8
17	u	
18	v	9
19	BB	
20	CC	10
21	DD	
22	EE	11
23	MM	
24	NN	12
Y	Y	

System cabling for controllers

VARIOFACE wiring interface

OV solid-state relays

Load current depending on ambient temperature
Operating time: 100% OT

OV-24DC/350DC/1

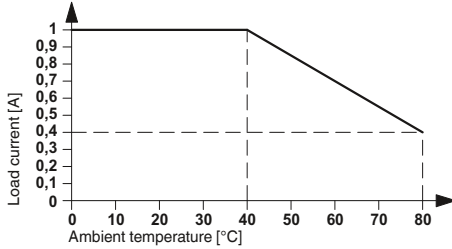

Dimensional drawing for SIM-AMS:

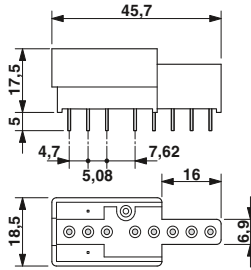

Dimensional drawing for SIM-AMSC:

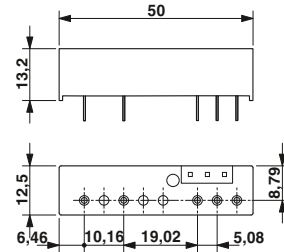

OV-24DC/60DC/4

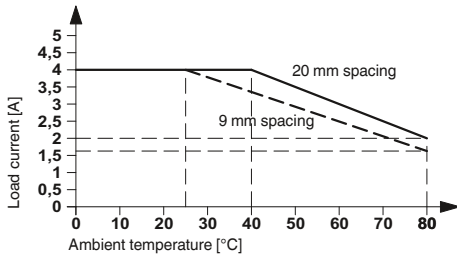

Dimensional drawing for SIM-AMS...R:

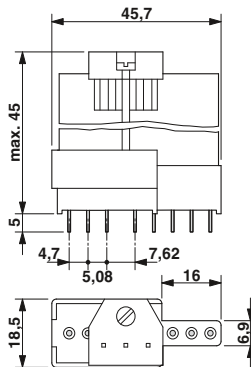

Contacts in the SIM-AMSC plug-in base:

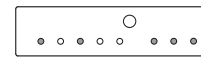

- With metal
- Without metal

Note:
4th generation optocoupler, available from Opto 22.

OV-24DC/480AC/5

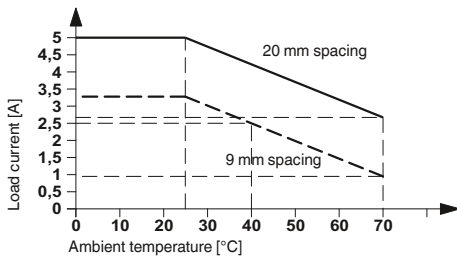

Contacts in the SIM-AMS plug-in base
1. Partial assembly for standard I/O modules

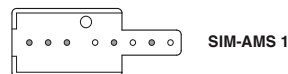

2. Complete assembly, e.g., for analog I/O modules

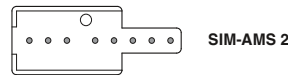

- With metal
- Without metal

Quality in quantity

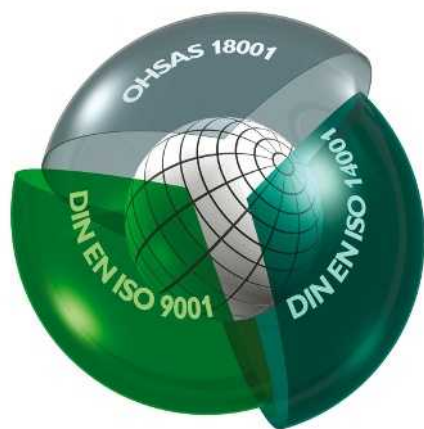

Integrated management system

The aim of the Phoenix Contact integrated management system is to coordinate all the requirements regarding products, processes, and organization.

Statutory and regulatory requirements, as well as those of international standards and our customers, are met and, in some cases, even exceeded in all phases of the product life cycle.

In the Phoenix Contact management system, the integration of quality, environmental protection, and safety in the workplace is monitored each year for conformance by internationally recognized independent bodies. Certification in accordance with international standards ISO 9001, ISO 14001, and BS OHSAS 18001 is the result of our corporate philosophy of meeting the needs of our customers, staff, and environment as best as possible. They serve as the basis for innovative products with the familiar high Phoenix quality standard, actively practiced environmental protection, and responsibility in the field of occupational health and safety. Of course, we integrate all further requirements of standards, international approvals or special customer requirements into company processes.

This system provides a building block for the success of the Phoenix Contact Group and its products and services.

CE marking

The CE mark was introduced as an important instrument for the free movement of goods and services within the single European market. By attaching the mark to a product, the manufacturer confirms that it complies with all applicable European Union (EU) directives. EC directives describe the product properties with regard to device safety and avoiding danger. These are legally binding regulations of the European Union (EU). In other words, compliance with the requirements is a **statutory condition for marketing the product within the EU.**

Where applicable, the products that our company currently manufactures fall within the scope of the following directives:

- 2006/95/EC
Electrical equipment designed for use within certain voltage limits (Low Voltage Directive)
- 2004/108/EC
Electromagnetic compatibility (EMC Directive)
- 2006/42/EC
Safety of machinery (Machinery Directive)
- 94/9/EC
Equipment and protective systems intended for use in potentially explosive areas (ATEX Directive 100a)
- 1999/5/EC
Radio and telecommunications terminal equipment (R&TTE)

The standards upon which the specified directives are based have been part of our standard of development for a long time. This guarantees conformance with European directives. The numbers of the directives indicate their version at the time of publication. In the event of changes to directives and/or standards, our products will undergo conformity assessment again in good time and a new declaration of conformity will be issued promptly. The current declarations for each product can also be found in our Download Center.

The EMC Directive occupies a special place among the European directives listed. It defines electromagnetic compatibility as a fundamental property of devices based on mandatory guidelines. European Law therefore acknowledges the electromagnetic compatibility of devices and systems as an important condition for error-free operation of machinery and systems. Phoenix Contact is one of the leading international companies in surge protection, and therefore possesses broad expertise in EMC. This expertise and the experience gained over years of developing and applying industrial interface and communication technology have resulted in our products having an extremely high standard of quality with regard to electromagnetic compatibility. It was with a view to providing other companies with this expertise that our associate company, Phoenix Testlab, was founded. Phoenix Testlab GmbH is an independent, accredited service provider offering EMC testing that conforms to European standards. At Phoenix Testlab, devices are also tested with regard to their electrical safety, mechanical influences, and their behavior in relation to environmental influences. Furthermore, Phoenix Testlab is a “Notified Body” in accordance with EMC Directive 2004/108/EC and according to R&TTE Directive 1999/5/EC for radio and telecom-

munications terminal equipment. As a “Telecom Certification Body” (TCB), Phoenix Testlab may also approve these products for markets in the USA, Canada, and Japan.

Standards and regulations

All relevant standards and regulations are used as the basis for the development and maintenance of our products.

International standards are subject to continuous changes as a result of harmonization and new developments. In line with this process, the current version of all standards that are relevant to our products is documented in the product area on our website at www.phoenixcontact.net/products.

Online product information service on the web

Phoenix Contact's product range is growing constantly.

Due to our commitment to product monitoring, all products are subject to improvement.

The Internet is an ideal platform to quickly communicate new product developments and improvements to the market.

You can quickly access the relevant Phoenix Contact website for your region via www.phoenixcontact.com. Here, you will always find the latest overview of products, solutions, and services from Phoenix Contact. This includes technical documents, such as data sheets and user manuals, the latest driver and demo software, plus a means of contacting the appropriate contact person directly.

Shock protection

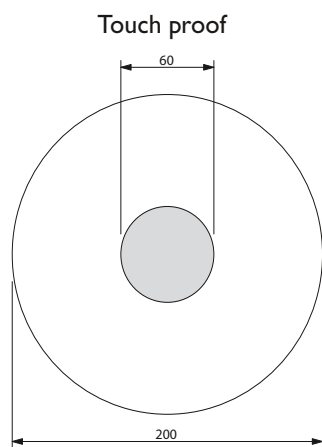

Back of hand safety

Example: pressure actuation

The accident prevention regulations BGV A 2 issued by the German employer's liability insurance association for precision mechanics and electrical engineering apply to the operators of electrical systems and are aimed at the prevention of electrical accidents by means of special safety requirements.

These regulations contain specifications regarding the safety distances for work, operation, and occasional handling in the proximity of "live parts" in low-voltage systems up to 1000 V ~ or 1500 V –.

- Work with live parts is only permitted once they have been de-energized. Operational activities are only permitted in the vicinity of live parts if these parts are de-energized or are protected against direct contact (§ 6). The following safety measures apply when working in the vicinity of active components:
- Provision of the de-energized state for the duration of the work
- Ensure shock protection is in place in the form of covers or barriers during the work
- Assurance that proximity limits will not be violated (§ 7)

The term "occasional handling" has been introduced for the operation of elements such as pushbuttons, rocker arms or rotary buttons in the proximity of live parts.

In VDE 0105-1, this is covered by "operation with partial protection against direct contact".

Detailed specifications for "occasional handling" can be found in DIN VDE 0106-100. This specifies to what degree live parts in the proximity of operating elements are to be protected against contact. The basis for this is the definition of a "protection area for occasional handling"; this is the area into which the user must reach in order to handle the machine.

The most important thing is that an area formed by an even envelope curve 30 mm in radius must surround the live parts. This area must be **touch proof**, i.e., the live parts of the electrical device must not be within reach of the VDE test finger in accordance with IEC 60529/DIN VDE 0470-1 (test finger).

Back of hand safety is specified for the "rest of the area" up to 100 mm around the operating element. **Back of hand safety** means that when a force of 50 N is applied to a ball with a diameter of 50 mm, this does not come into contact with the live parts of the



equipment. No special measures for shock protection are provided outside this area.

Note: systems and equipment that are operated with SELV up to 25 V ~ or 60 V – are considered to be protected against direct contact.

According to § 5, Subsection 4 of the BGV A 2 regulations, there is no need to test the condition of the system prior to initial startup if the company has confirmation from the manufacturer or installer that the electrical



systems and equipment conform to BGV A 2. The confirmation required relates to systems and equipment that have been installed and are ready for operation and can only be issued

by the installer or installation company. The manufacturer of the electrical equipment can only issue a confirmation that products have been produced in accordance with the relevant electrotechnical DIN VDE regulations stipulated in BGV A 2. The installer must bear this in mind when selecting the equipment to be used.

In the field of connection technology, Phoenix Contact offers a wide range of products that are touch proof or that can be protected against contact using covers. Depending on the conditions, all of this must be taken into account when selecting the individual types of terminal block and accessories.

Quality features of insulating housing

Thermoplastics

The majority of our insulating housing is made from thermoplastic materials. Roughly speaking, these can be divided into amorphous and semi-crystalline substances. Thermoplastics are processed using the efficient and environmentally-friendly injection molding process. They have good recycling properties and can be re-used. We use many materials that are modified in different ways to meet the demanding requirements that electrical and electronic modules, devices, and systems have to meet with regard to their mechanical, thermal, and electrical properties.

Behavior of plastics under the influence of temperature (operating temperatures, mechanical influences)

All plastics undergo a process referred to as thermal aging when they are subjected to heat over long periods. This process causes changes in the mechanical and electrical properties of the material. External influences, e.g., radiation, additional mechanical, chemical or electrical stresses, amplify this effect. Special tests on samples can yield characteristic data which provides a good means of drawing comparisons between different plastics. However, applying these characteristics to an evaluation of molded plastic parts is only possible to a limited extent, and can only give the designer a rough guide when it comes to selecting a plastic material. This catalog uses the following assessment criteria: the **RTI value** according to UL746B/ANSI 746 B (elec. based on dielectric strength) and the **Ti value** according to IEC 60216-1 (based on a 50% reduction in tensile strength after 20,000 hours).

IEC 60947-7-1/EN 60947-7-1 specifies a permissible temperature increase of 45 K for modular terminal blocks under nominal load. Phoenix Contact terminal blocks meet this requirement.

The properties of plastics are not only affected by the influence of heat as described above; they also undergo changes as a result of cold influences. When subjected to cold as well as low levels of humidity, plastics become increasingly brittle with the result that they are no longer capable of withstanding the same mechanical loads. As the table on the right shows, the plastics concerned can be used down to a temperature of -40°C, but only without a mechanical load. As far as the products presented in the catalog are concerned, it is the ambient temperature specified in each case that is to be regarded as definitive for operation. Regardless of the plastics used, this may be subject to further restrictions (e.g., limited to -20°C) as a result of the components used or other restrictive parameters.

At very low temperatures, this means that any form of mechanical load on the plastic components must be avoided (e.g., mounting of products on/removal of products from the DIN rail, actuation of terminal points, locking/ejection of relays from bases, prizing out of plug-in bridges, bending of cables and lines, etc.), as there is always an associated risk of damage. Unless otherwise indicated, it is recommended that you carry out the specified mounting/operational tasks in a temperature range from -10°C to +40°C.

Inflammability characteristics of plastics (UL 94)

Inflammability tests for plastics have been defined by Underwriters Laboratories (USA) in regulation UL 94. This applies to all areas of application, but in particular to electrical engineering. A horizontal or vertical test is carried out at the test laboratory to determine the inflammability of the plastic material with a naked flame. In order of increasing resistance to combustion, the evaluation classes are HB, V2, V1, V0, and 5V. Test results are recorded on "yellow cards" and are published annually in the **Recognized Component Directory**.

Thermoplastics:

non-reinforced polyamide, PA

We use the modern, semi-crystalline polyamide insulation material, which has now become an essential component in electrical engineering and electronics. It has long occupied a leading position and is authorized for use by the relevant approval authorities such as the CSA, NEMKO, KEMA, PTB, SEV, UL, VDE, etc.

Polyamide also has excellent electrical, mechanical, chemical, and other properties, even at high operating temperatures. Brief peak temperatures up to approximately 200°C are permitted as a result of heat aging stabilization. Depending on the type (PA 4.6, 6.6, 6.10, etc.), its melting point is in the region of 215°C to 295°C.

Polyamide absorbs moisture from its surroundings, on average 2.8%. However, this moisture is not in the form of crystallization water in the plastic itself, but chemically bonded H₂O groups in the molecule structure. This makes the plastic flexible and resistant to breakage, even at temperatures as low as -40°C. According to UL 94, PA belongs to inflammability class V2 to V0.

Thermoplastics: polyester, PBT

We use the semi-crystalline thermoplastic polyester in non-reinforced and fiberglass-reinforced variants for special applications which require increased dimensional and form stability.

In addition to the high operating temperature, the material is characterized by excellent mechanical strength and hardness, and does not absorb moisture from its surroundings. PBT is therefore particularly suitable for strips, for example, which are soldered onto PCBs and subsequently have to pass a burn-in test while they are subjected to heat. According to UL 94, PBT belongs to inflammability class V2 to V0.

Thermoplastics: polycarbonate, PC

Polycarbonate combines many advantages such as rigidity, impact strength, transparency, dimensional stability, good insulation properties, and resistance to heat.

This amorphous material only absorbs moisture to a very limited degree, and is used for items such as large, rigid electronic component housing.

In its transparent form, polycarbonate is particularly suitable for use as cover profiles or marking materials.

PC has good resistance properties against mineral acids, saturated aliphatic hydrocarbons, gasoline, greases, and oils.

The material is less resistant to solvents, benzene, lyes, acetone, and ammonia. Strain cracks may result from contact with certain chemicals.

According to UL 94, PC belongs to inflammability class V2 to V0.

Thermoplastics: polycarbonate fiber-reinforced, PC-F

Compared to non-reinforced materials, fiber-reinforced polycarbonates feature greater rigidity, impact strength, and operating temperature. In other respects, their properties are largely identical to those of non-reinforced polycarbonate.

Thermoplastics: ABS

We use the thermoplastic molding compound ABS for products which must have good impact and notched impact properties in addition to high mechanical stability and rigidity. The products are resistant to chemicals and stress cracking due to their special surface quality and hardness.

The characteristic thermal properties provide good dimensional stability at both low and high temperatures. Products made from ABS can be coated with metallic surfaces, e.g., nickel.

According to UL 94, the molding compound used belongs to inflammability class HB to V0.

Dimensions: width / height / depth

The dimensions for “width / height / depth” are defined as follows for all DIN-rail-mountable products in the INTERFACE range:

- Width: measurement taken along the DIN rail
- Height: measurement taken across the DIN rail
- Depth: measurement taken starting from the mounting plate and including the NS 35/7,5 DIN rail (EN 60715)

The width, height, and depth never change, even if the products shown in this catalog happen to be photographed from two different perspectives (horizontal or vertical).

To make things easier for you, one of the following two symbols has been included next to each product photo:



Properties	Unit/level	Polyamide PA	Polyester PBT	Polycarbonate PC	Polycarbonate PC-F	ABS
Operating temperature	RTI **	≤ 105	≤ 105	≤ 125	≤ 120	≤ 80
Minimum temperature (without mechanical load)		-40	-40	-40	-40	-40
Dielectric strength according to IEC 60243-1/DIN VDE 0303-21	kV/cm	600	400	> 300		850
Creep resistance	CTI...M	550	225	175		200
IEC 60112/DIN VDE 0303-1	CTI...	600	225	175	175	600
Tropical and termite resistance		Good	Good	Good		
Specific contact resistance IEC 60093/VDE 0303 Part 30; IEC 60167/VDE 0303 Part 31	Ω cm	10 ¹²	10 ¹⁶	> 10 ¹⁶	> 10 ¹⁴	10 ¹⁴
Surface resistance IEC 60093/VDE 0303 Part 30; IEC 60167/VDE 0303 Part 31	Ω	10 ¹⁰	10 ¹³	> 10 ¹⁴		10 ¹³
Inflammability class according to UL 94		V2 - V0	V0	V2 - V0	V0	HB - V0
* According to UL 746 B/ANSI 746 B (elec.)		** Minimum value				

Connection cross section

The rated cross section of modular terminal blocks must be specified by the manufacturer in accordance with IEC 60947-7-1. The rated cross section is the maximum conductor cross section that can be connected in single-, multi- or fine-strand versions subject to specific thermal, mechanical, and electrical requirements.

The manufacturer must also specify the **rated connection capacity**, i.e., the area of the conductor that can be connected, as well as the number of conductors that can be connected simultaneously and the necessary preparation of the conductor ends. The conductors can be **solid (single or multi-**

strand) or stranded (fine-strand).

These values can be found in the product-specific technical data.

The rated connection capacity of Phoenix Contact modular terminal blocks usually exceeds standard requirements, which specify that it must only be possible to connect one conductor with one of the two next smallest cross sections, excluding the rated cross section (standardized for the cross section range from 0.2 to 35 mm²).

In addition, conductors with a rated cross section can usually be wired with ferrules with plastic sleeve.

Phoenix Contact modular terminal blocks

are designed to allow copper conductors to be connected to them untreated. "Special treatment" or the use of ferrules – both permitted according to IEC 60947-7-1 – is not required. If ferrules are nevertheless used to protect stranded conductors against splicing, the connection capacity of the stranded conductor is generally reduced by one level.

Structure and dimensions of connecting cables													
Cross section [mm ²]	Single-strand		Multi-strand		Fine-strand		American Wire Gauge [AWG]						
	Diameter max. dimension	Number of wires	Diameter max. dimension	Number of wires (minimum number)	Diameter max. dimension	Number of wires (guide value)	Gauge No. AWG	Solid wires			Stranded wires		
							[Ø mm]	[circ. mils]	[mm ²]		[Ø mm]	[circ. mils]	[mm ²]
0.2	0.5	1	–	–	–	–	24	0.51	404	0.21	–	–	–
0.5	0.9	1	1.1	7	1.1	16	20	0.81	1022	0.52	0.97	1111	0.56
0.75	1.0	1	1.2	7	1.3	24	18	1.02	1620	0.82	1.16	1600	0.82
1	1.2	1	1.4	7	1.5	32	(17)	1.15	2050	1.04			
–	–	–	–	–	–	–	16	1.29	2580	1.31	1.50	2580	1.32
1.5	1.5	1	1.7	7	1.8	30	(15)	1.45	3260	1.65			
–	–	–	–	–	–	–	14	1.63	4110	2.08	1.85	4100	2.09
2.5	1.9	1	2.2	7	2.3	50	(13)	1.83	5180	2.63			
–	–	–	–	–	–	–	12	2.05	6530	3.31	2.41	6500	3.32
4	2.4	1	2.7	7	2.9	56	(11)	2.30	8230	4.17			
–	–	–	–	–	–	–	10	2.59	10380	5.26	2.95	10530	5.37
6	2.9	1	3.3	7	3.9	84	(9)	2.91	13100	6.63			
–	–	–	–	–	–	–	8	3.26	16510	8.37	3.73	16625	8.48

Tightening torque of terminal block screws

IEC 60947-1/EN 60947-1, modified, Table 4 specifies tightening torques for screw connections based on the screw size for electrical and mechanical type tests.

Extract from IEC 60 947-1/EN 60 947-1, Table 4

The torque according to IEC and the recommended tightening torque for Phoenix Contact terminal blocks are specified.

Thread	Head screw with slot	
	Torque [Nm]	Recommended tightening torque [Nm]
M2.5 (M2.6)	0.4	0.4 - 0.5
M3	0.5	0.5 - 0.6
M3.5	0.8	0.8 - 1.0
M4	1.2	1.2 - 1.5







































Current carrying capacity

Standard IEC 60947-7-1/EN 60947-7-1/DIN VDE 0611-1 specifies the test currents for the individual conductor cross sections listed in the adjacent table. The corresponding currents are listed with the connection data for the individual terminal blocks. The type tests for modular terminal blocks are based on this data.

Test currents according to IEC 60947-7-1/EN 60947-7-1, Table 5

Rated cross section	[mm ²]	0.2	0.5	0.75	1.0	1.5	2.5	4	6	10	16
Test current	[A]	4	6	9	13.5	17.5	24	32	41	57	76

Overview of certification bodies and safety marks

Certification bodies and approvals		Country code	Explosion protection		Country code	Ship classification societies		Country code
	IECEE CB Scheme (in combination with certifying body)	International		FM Approvals	US		Bureau Veritas	FR
CCA	CENELEC Certification Agreement (CCA inspection report) (in combination with certifying body)	EU		DEKRA Certification B.V.	NL		Germanischer Lloyd AG	DE
	Canadian Standards Association (CSA)	CA		Physikalisch-Technische Bundesanstalt	DE		Lloyd's Register EMEA	GB
 	Underwriters Laboratories Inc. (UL)	US		QS Schaffhausen	CH	ClassNK	Nippon Kaiji Kyokai	JP
 	Underwriters Laboratories Inc. (UL) - UL approval for Canada -	CA		VTT Expert Services Oy	FI		Det Norske Veritas	NO
  	Underwriters Laboratories Inc. (UL) Combined logo - UL approval for the USA and Canada -	US CA	IBExU	IBExU Institut für Sicherheitstechnik GmbH	DE		Polski Rejestr Statków	PL
	INSIEME PER LA QUALITA'E LA SICUREZZA	IT		TÜV Rheinland do Brasil	BR		Russian Maritime Register of Shipping	RU
	Gosudarstvenne Komitet Standartov (GOST)	RU	 	Underwriters Laboratories Inc. (UL)	US		Korean Register of Shipping	KR
	DEKRA Certification B.V.	NL		TÜV Nord	DE		American Bureau of Shipping	US
	Österreichischer Verband für Elektrotechnik	AT		DEKRA EXAM GmbH	DE			
	South African Bureau of Standards	ZA						
	electrosuisse SEV Verband für Elektro-, Energie- und Informationstechnik	CH						
 	Verband Deutscher Elektrotechniker e.V.(VDE) – Approval of drawings – Reports with production monitoring	DE						
 	Berufsgenossenschaft (BG) GS - Geprüfte Sicherheit	DE						
	TÜV Rheinland Industrie Service GmbH	DE						

EMC: Class A product:

In accordance with statutory regulations, our products are indicated with this footnote if they are intended for use in industrial environments. This means that the permissible limit values for residential applications may be exceeded in the event of conducted and emitted interference. In such cases, the operator may have to take additional safety measures in order to ensure electromagnetic compatibility in residential applications.

Note:

Subject to changes that serve the purpose of technical progress.

Index

Alphabetical

Type	Order No.	Page	Type	Order No.	Page	Type	Order No.	Page	Type	Order No.	Page
			CABLE-D-15SUB/M/OE/0,25/S/0,5M	2926438	516	CABLE-D25SUB/B/S/300/KONFEK/S	2302162	512	CABLE-FCN40/1X50/3,0M/IM/MEL	2903471	441
			CABLE-D-15SUB/M/OE/0,25/S/1,0M	2926441	516	CABLE-D25SUB/B/S/400/KONFEK/S	2302175	512	CABLE-FCN40/1X50/3,0M/IP/MEL	2903479	441
			CABLE-D-15SUB/M/OE/0,25/S/1,5M	2926454	516	CABLE-D25SUB/B/S/600/KONFEK/S	2302188	512	CABLE-FCN40/1X50/3,0M/M340	2321664	447
			CABLE-D-15SUB/M/OE/0,25/S/2,0M	2926467	516	CABLE-D25SUB/S/S/100/KONFEK/S	2305635	513	CABLE-FCN40/1X50/3,0M/S7-IN	2321127	453
B											
B-STIFT	1051993	560	CABLE-D-15SUB/M/OE/0,25/S/3,0M	2926470	516	CABLE-D25SUB/S/S/200/KONFEK/S	2305648	513	CABLE-FCN40/1X50/3,0M/S7-OUT	2321046	453
BN-TRK	2701404	560	CABLE-D-15SUB/M/OE/0,25/S/4,0M	2926483	516	CABLE-D25SUB/S/S/300/KONFEK/S	2305651	513	CABLE-FCN40/1X50/4,0M/IM/MEL	2903472	441
BRIDGE-2	2900746	36	CABLE-D-15SUB/M/OE/0,25/S/6,0M	2926496	516	CABLE-D37-M2,5-4X14-X81-I/...	2302706	440	CABLE-FCN40/1X50/4,0M/IP/MEL	2903480	441
BRIDGE-2-3M	2901543	37	CABLE-D-25SUB-F-OE-0,25-S/...	2900906	516	CABLE-D37-M2,5-4X14-Y81P-O/...	2302696	440	CABLE-FCN40/1X50/4,0M/M340	2321677	447
BRIDGE-3	2900747	36	CABLE-D-25SUB-M-OE-0,25-S/...	2900911	516	CABLE-D37-M2,5/4X14/50/X81-I	2302515	440	CABLE-FCN40/1X50/4,0M/S7-IN	2321130	453
BRIDGE-3-3M	2901656	37	CABLE-D-25SUB/F/OE/0,25/S/0,5M	2926153	516	CABLE-D37-M2,5/4X14/50/Y81P-O	2302476	440	CABLE-FCN40/1X50/4,0M/S7-OUT	2321059	453
BRIDGE-4	2900748	36	CABLE-D-25SUB/F/OE/0,25/S/1,0M	2926166	516	CABLE-D37-M2,5/4X14/100/X81-I	2302528	440	CABLE-FCN40/1X50/6,0M/IM/MEL	2903473	441
BRIDGE-4-3M	2901659	37	CABLE-D-25SUB/F/OE/0,25/S/1,5M	2926179	516	CABLE-D37-M2,5/4X14/100/Y81P-O	2302489	440	CABLE-FCN40/1X50/6,0M/IP/MEL	2903481	441
BRIDGE-5	2900749	36	CABLE-D-25SUB/F/OE/0,25/S/2,0M	2926182	516	CABLE-D37-M2,5/4X14/200/X81-I	2302531	440	CABLE-FCN40/1X50/6,0M/M340	2321680	447
BRIDGE-5-3M	2901545	37	CABLE-D-25SUB/F/OE/0,25/S/3,0M	2926195	516	CABLE-D37-M2,5/4X14/200/Y81P-O	2302492	440	CABLE-FCN40/1X50/6,0M/S7-IN	2321143	453
BRIDGE-6	2900750	36	CABLE-D-25SUB/F/OE/0,25/S/4,0M	2926205	516	CABLE-D37-M2,5/4X14/300/X81-I	2302544	440	CABLE-FCN40/1X50/6,0M/S7-OUT	2321062	453
BRIDGE-6-3M	2901697	37	CABLE-D-25SUB/F/OE/0,25/S/6,0M	2926218	516	CABLE-D37-M2,5/4X14/300/Y81P-O	2302502	440	CABLE-FCN40/1X50/8,0M/IM/MEL	2903474	441
BRIDGE-7	2900751	36	CABLE-D-25SUB/M/OE/0,25/S/0,5M	2926506	516	CABLE-D37SUB/B/B/100/KONFEK/S	2305509	513	CABLE-FCN40/1X50/8,0M/IP/MEL	2903482	441
BRIDGE-7-3M	2901698	37	CABLE-D-25SUB/M/OE/0,25/S/1,0M	2926519	516	CABLE-D37SUB/B/B/200/KONFEK/S	2305512	513	CABLE-FCN40/1X50/8,0M/M340	2321693	447
BRIDGE-8	2900752	36	CABLE-D-25SUB/M/OE/0,25/S/1,5M	2926522	516	CABLE-D37SUB/B/B/300/KONFEK/S	2305525	513	CABLE-FCN40/1X50/8,0M/S7-IN	2321156	453
BRIDGE-8-3M	2901700	37	CABLE-D-25SUB/M/OE/0,25/S/2,0M	2926535	516	CABLE-D37SUB/B/B/400/KONFEK/S	2900759	513	CABLE-FCN40/1X50/8,0M/S7-OUT	2321075	453
BRIDGE-9	2900753	36	CABLE-D-25SUB/M/OE/0,25/S/3,0M	2926548	516	CABLE-D37SUB/B/B/600/KONFEK/S	2900760	513	CABLE-FCN40/1X50/10,0M/IM/MEL	2903475	441
BRIDGE-9-3M	2901701	37	CABLE-D-25SUB/M/OE/0,25/S/4,0M	2926551	516	CABLE-D37SUB/B/B/800/KONFEK/S	2900761	513	CABLE-FCN40/1X50/10,0M/IP/MEL	2903483	441
BRIDGE-10	2900754	36	CABLE-D-25SUB/M/OE/0,25/S/6,0M	2926564	516	CABLE-D37SUB/B/B/1000/KONFEK/S	2900762	513	CABLE-FCN40/1X50/10,0M/M340	2321703	447
BRIDGE-10-3M	2901702	37	CABLE-D-37SUB-F-OE-0,25-S/...	2900907	517	CABLE-D37SUB/B/B/1500/KONFEK/S	2900763	513	CABLE-FCN40/1X50/10,0M/S7-IN	2321169	453
			CABLE-D-37SUB-M-OE-0,25-S/...	2900912	517	CABLE-D37SUB/B/B/2000/KONFEK/S	2900764	513	CABLE-FCN40/1X50/10,0M/S7-OUT	2321088	453
			CABLE-D-37SUB/F/OE/0,25/S/0,5M	2926221	517	CABLE-D37SUB/B/S/50/KONFEK/S	2302191	512	CABLE-FCN40/1X50/15,0M/M340	2903748	447
			CABLE-D-37SUB/F/OE/0,25/S/1,0M	2926234	517	CABLE-D37SUB/B/S/100/KONFEK/S	2302201	512	CABLE-FCN40/4X14/0,5M/IM/MEL	2903502	441
			CABLE-D-37SUB/F/OE/0,25/S/1,5M	2926247	517	CABLE-D37SUB/B/S/150/KONFEK/S	2302214	512	CABLE-FCN40/4X14/0,5M/M340	2321716	447
C											
CABLE D-SUB-B-B-S/.../.../...	2302421	515	CABLE-D-37SUB/F/OE/0,25/S/2,0M	2926250	517	CABLE-D37SUB/B/S/200/KONFEK/S	2302227	512	CABLE-FCN40/4X14/0,5M/S7-IN	2321253	453
CABLE D-SUB-S-S-S/.../.../...	2302434	515	CABLE-D-37SUB/F/OE/0,25/S/3,0M	2926263	517	CABLE-D37SUB/B/S/300/KONFEK/S	2302230	512	CABLE-FCN40/4X14/0,5M/S7-OUT	2321172	453
CABLE D-SUB-S/.../.../...	2302340	515	CABLE-D-37SUB/F/OE/0,25/S/4,0M	2926276	517	CABLE-D37SUB/B/S/400/KONFEK/S	2302243	512	CABLE-FCN40/4X14/1,0M/IM/MEL	2903503	441
CABLE-D-2FLK16/2,0M/YUC	2321334	467	CABLE-D-37SUB/F/OE/0,25/S/6,0M	2926289	517	CABLE-D37SUB/B/S/600/KONFEK/S	2302256	512	CABLE-FCN40/4X14/1,0M/M340	2321729	447
CABLE-40/2FLK16/4,0M/YUC	2321347	467	CABLE-D-37SUB/M/OE/0,25/S/0,5M	2926577	517	CABLE-D37SUB/S/S/100/KONFEK/S	2305664	513	CABLE-FCN40/4X14/1,0M/S7-IN	2321266	453
CABLE-40/2FLK16/10,0M/YUC	2321350	467	CABLE-D-37SUB/M/OE/0,25/S/1,0M	2926580	517	CABLE-D37SUB/S/S/200/KONFEK/S	2305677	513	CABLE-FCN40/4X14/1,0M/S7-OUT	2321185	453
CABLE-40/2FLK16/15,0M/YUC	2321376	467	CABLE-D-37SUB/M/OE/0,25/S/1,5M	2926593	517	CABLE-D37SUB/S/S/300/KONFEK/S	2305680	513	CABLE-FCN40/4X14/2,0M/IM/MEL	2903504	441
CABLE-40/2FLK16/20,0M/YUC	2321363	467	CABLE-D-37SUB/M/OE/0,25/S/2,0M	2926603	517	CABLE-D50SUB/B/B/100/KONFEK/S	2305541	513	CABLE-FCN40/4X14/2,0M/M340	2321732	447
CABLE-50/4FLK14/2,0M/YUC	2314655	467	CABLE-D-37SUB/M/OE/0,25/S/3,0M	2926616	517	CABLE-D50SUB/B/B/200/KONFEK/S	2305554	513	CABLE-FCN40/4X14/2,0M/S7-IN	2321279	453
CABLE-50/4FLK14/4,0M/YUC	2314671	467	CABLE-D-37SUB/M/OE/0,25/S/4,0M	2926629	517	CABLE-D50SUB/B/B/300/KONFEK/S	2305567	513	CABLE-FCN40/4X14/2,0M/S7-OUT	2321198	453
CABLE-50/4FLK14/6,0M/YUC	2318978	467	CABLE-D-37SUB/M/OE/0,25/S/6,0M	2926632	517	CABLE-D50SUB/B/S/50/KONFEK/S	2302269	512	CABLE-FCN40/4X14/3,0M/IM/MEL	2903505	441
CABLE-50/4FLK14/10,0M/YUC	2314684	467	CABLE-D-50SUB-F-OE-0,25-S/...	2900908	517	CABLE-D50SUB/B/S/100/KONFEK/S	2302272	512	CABLE-FCN40/4X14/3,0M/M340	2321745	447
CABLE-50/4FLK14/15,0M/YUC	2322773	467	CABLE-D-50SUB-M-OE-0,25-S/...	2900913	517	CABLE-D50SUB/B/S/150/KONFEK/S	2302285	512	CABLE-FCN40/4X14/3,0M/S7-IN	2321282	453
CABLE-50/4FLK14/20,0M/YUC	2314778	467	CABLE-D-50SUB/F/OE/0,25/S/3,5M	2926292	517	CABLE-D50SUB/B/S/200/KONFEK/S	2302298	512	CABLE-FCN40/4X14/3,0M/S7-OUT	2321208	453
CABLE-D-9SUB/B/S/100/KONFEK/S	2305415	513	CABLE-D-50SUB/F/OE/0,25/S/4,0M	2926302	517	CABLE-D50SUB/B/S/300/KONFEK/S	2302308	512	CABLE-FCN40/4X14/4,0M/IM/MEL	2903506	441
CABLE-D-9SUB/B/S/200/KONFEK/S	2305428	513	CABLE-D-50SUB/F/OE/0,25/S/1,5M	2926315	517	CABLE-D50SUB/B/S/400/KONFEK/S	2302311	512	CABLE-FCN40/4X14/4,0M/M340	2321758	447
CABLE-D-9SUB/B/B/300/KONFEK/S	2305431	513	CABLE-D-50SUB/F/OE/0,25/S/2,0M	2926328	517	CABLE-D50SUB/B/S/600/KONFEK/S	2302324	512	CABLE-FCN40/4X14/4,0M/S7-IN	2321295	453
CABLE-D-9SUB/B/S/50/KONFEK/S	2299987	512	CABLE-D-50SUB/F/OE/0,25/S/3,0M	2926331	517	CABLE-D50SUB/S/S/100/KONFEK/S	2305693	513	CABLE-FCN40/4X14/4,0M/S7-OUT	2321211	453
CABLE-D-9SUB/B/S/100/KONFEK/S	2299990	512	CABLE-D-50SUB/F/OE/0,25/S/4,0M	2926344	517	CABLE-D50SUB/S/S/200/KONFEK/S	2305703	513	CABLE-FCN40/4X14/6,0M/IM/MEL	2903507	441
CABLE-D-9SUB/B/S/150/KONFEK/S	2300009	512	CABLE-D-50SUB/F/OE/0,25/S/6,0M	2926357	517	CABLE-D50SUB/S/S/300/KONFEK/S	2305716	513	CABLE-FCN40/4X14/6,0M/M340	2321761	447
CABLE-D-9SUB/B/S/200/KONFEK/S	2302010	512	CABLE-D-50SUB/M/OE/0,25/S/0,5M	2926645	517	CABLE-EC56-F-OE-0,34-S/...	2904025	518	CABLE-FCN40/4X14/6,0M/S7-IN	2321305	453
CABLE-D-9SUB/B/S/300/KONFEK/S	2302023	512	CABLE-D-50SUB/M/OE/0,25/S/1,0M	2926658	517	CABLE-EC56/F/OE/0,34/S/1,0M	2903395	518	CABLE-FCN40/4X14/6,0M/S7-OUT	2321224	453
CABLE-D-9SUB/B/S/400/KONFEK/S	2302036	512	CABLE-D-50SUB/M/OE/0,25/S/1,5M	2926661	517	CABLE-EC56/F/OE/0,34/S/2,0M	2903396	518	CABLE-FCN40/4X14/8,0M/IM/MEL	2903508	441
CABLE-D-9SUB/B/S/600/KONFEK/S	2302049	512	CABLE-D-50SUB/M/OE/0,25/S/2,0M	2926674	517	CABLE-EC56/F/OE/0,34/S/4,0M	2903397	518	CABLE-FCN40/4X14/8,0M/M340	2321774	447
CABLE-D-9SUB/S/S/100/KONFEK/S	2305570	513	CABLE-D-50SUB/M/OE/0,25/S/3,0M	2926687	517	CABLE-EC56/F/OE/0,34/S/6,0M	2903398	518	CABLE-FCN40/4X14/8,0M/S7-IN	2321318	453
CABLE-D-9SUB/S/S/200/KONFEK/S	2305583	513	CABLE-D-50SUB/M/OE/0,25/S/4,0M	2926690	517	CABLE-EC56/F/OE/0,34/S/8,0M	2903399	518	CABLE-FCN40/4X14/8,0M/S7-OUT	2321237	453
CABLE-D-9SUB/S/S/300/KONFEK/S	2305596	513	CABLE-D-50SUB/M/OE/0,25/S/6,0M	2926700	517	CABLE-EC56/F/OE/0,34/S/10,0M	2903400	518	CABLE-FCN40/4X14/10,0M/IM/MEL	2903509	441
CABLE-D-9SUB-F-OE-0,25-S/...	2900903	516	CABLE-D15SUB/B/B/100/KONFEK/S	2305444	513	CABLE-EC56/F/OE/0,34/S/15,0M	2903401	518	CABLE-FCN40/4X14/10,0M/M340	2321787	447
CABLE-D-9SUB-M-OE-0,25-S/...	2900909	516	CABLE-D15SUB/B/B/200/KONFEK/S	2305457	513	CABLE-EC56/F/OE/0,34/S/20,0M	2903402	518	CABLE-FCN40/4X14/10,0M/S7-IN	2321321	453
CABLE-D-9SUB/F/OE/0,25/S/0,5M	2926014	516	CABLE-D15SUB/B/B/300/KONFEK/S	2305460	513	CABLE-FCN24-2X14-OMR-IN/...	2302845	442	CABLE-FCN40/4X14/10,0M/S7-OUT	2321240	453
CABLE-D-9SUB/F/OE/0,25/S/1,0M	2926027	516	CABLE-D15SUB/B/S/50/KONFEK/S	2302052	512	CABLE-FCN24-2X14-OMR-OUT/...	2302858	442	CABLE-FCN40/4X14/100/OMR-IN	2304209	442
CABLE-D-9SUB/F/OE/0,25/S/1,5M	2926030	516	CABLE-D15SUB/B/S/100/KONFEK/S	2302065	512	CABLE-FCN24/2X14/100/OMR-IN	2304241	442	CABLE-FCN40/4X14/100/OMR-OUT	2304186	442
CABLE-D-9SUB/F/OE/0,25/S/2,0M	2926043	516	CABLE-D15SUB/B/S/150/KONFEK/S	2302078	512	CABLE-FCN24/2X14/100/OMR-OUT	2304225	442	CABLE-FCN40/4X14/15,0M/M340	2903749	447
CABLE-D-9SUB/F/OE/0,25/S/3,0M	2926056	516	CABLE-D15SUB/B/S/200/KONFEK/S	2302081	512	CABLE-FCN24/2X14/200/OMR-IN	2304254	442	CABLE-FCN40/4X14/200/OMR-IN	2304212	442
CABLE-D-9SUB/F/OE/0,25/S/4,0M	2926069	516	CABLE-D15SUB/B/S/300/KONFEK/S	2302094	512	CABLE-FCN24/2X14/200/OMR-OUT	2304238	442	CABLE-FCN40/4X14/200/OMR-OUT	2304199	442
CABLE-D-9SUB/F/OE/0,25/S/6,0M	2926072	516	CABLE-D15SUB/B/S/400/KONFEK/S	2302104	512	CABLE-FCN40-4X14-OMR-IN/...	2302816	442	CABLE-FLK10-OE-0,14/...	2904331	502
CABLE-D-9SUB/M/OE/0,25/S/0,5M	2926360	516	CABLE-D15SUB/B/S/600/KONFEK/S	2302117	512	CABLE-FCN40-4X14-OMR-OUT/...	2302832	442	CABLE-FLK10/OE/0,14/0,5M	2904073	502
CABLE-D-9SUB/M/OE/0,25/S/1,0M	2926373										

Type	Order No.	Page	Type	Order No.	Page	Type	Order No.	Page	Type	Order No.	Page
CABLE-FLK14/OE/0,14/ 400	2305774	502	DEK-OV- 12DC/240AC/800	2964636	401	EEM-MEMO-MA600	2901370	202	ELR W3- 24DC/500AC- 9I	2297057	19
CABLE-FLK14/OE/0,14/ 600	2305787	502	DEK-OV- 24DC/ 24DC/ 3	2941374	401	EEM-MKT-DRA	2902078	205	ELR W3- 24DC/500AC-16	2297332	39
CABLE-FLK14/OE/0,14/ 800	2305790	502	DEK-OV- 24DC/ 24DC/ 3/AKT	2964296	401	EEM-PB-MA600	2901368	203	ELR W3-230AC/500AC- 2	2297303	38
CABLE-FLK14/OE/0,14/...	2305732	502	DEK-OV- 24DC/ 24DC/ 10	2964322	401	EEM-PB12-MA600	2901418	203	ELR W3-230AC/500AC- 2I	2297044	18
CABLE-FLK14/OE/0,14/1000	2305800	502	DEK-OV- 24DC/240AC/800	2964649	401	EEM-RS485-MA400	2901365	203	ELR W3-230AC/500AC- 9I	2297329	39
CABLE-FLK16/OE/0,14/ 0,5M	2318127	502	DEK-REL- 5/I/1	2941183	398	EEM-RS485-MA600	2901367	203	ELR W3-230AC/500AC- 9	2297060	19
CABLE-FLK16/OE/0,14/ 1,0M	2318130	502	DEK-REL- 5/O/1	2941170	399	EEM-TEMP-MA600	2901949	204	ELR W3-230AC/500AC-16	2297345	39
CABLE-FLK16/OE/0,14/ 1,5M	2318143	502	DEK-REL- 24/1/AKT	2964063	399	EIK1-SVN-24P	2940799	412	ELR W3/ 9-400 S	2963569	42
CABLE-FLK16/OE/0,14/ 2,0M	2318156	502	DEK-REL- 24/1/S	2964131	403	EL1-P16	2833547	372	EM RD-ADAPTER	2902747	29
CABLE-FLK16/OE/0,14/ 2,5M	2318169	502	DEK-REL- 24/1/SEN	2964050	399	EL1-P25	2833550	372	EM RI-ADAPTER CLASSIC	2902831	29
CABLE-FLK16/OE/0,14/ 3,0M	2318172	502	DEK-REL- 24/1/I	2940171	398	EL2-P35	2833592	378	EM RI-ADAPTER COMPACT	2902748	29
CABLE-FLK16/OE/0,14/ 4,0M	2318185	502	DEK-REL- 24/O/1	2941154	399	EL3-M52	2833628	382	EM SWD-ADAPTER	2902776	32
CABLE-FLK16/OE/0,14/ 6,0M	2318198	502	DEK-REL-G24/21	2964500	397	ELR 1- 24DC/600AC-20	2297138	46	EM-CAN-GATEWAY-IFS	2901504	14
CABLE-FLK16/OE/0,14/ 8,0M	2318208	502	DEK-TR/INV	2964319	413	ELR 1- 24DC/600AC-30	2297154	47	EM-CP-PP-ETH	2902802	247
CABLE-FLK16/OE/0,14/...	2318224	502	DFLK 10/FKCT	2903034	531	ELR 1- 24DC/600AC-50	2297170	47	EM-DNET-GATEWAY-IFS	2901529	14
CABLE-FLK16/OE/0,14/10,0M	2318211	502	DFLK 14/FKCT	2903035	531	ELR 1-230AC/600AC-20	2297141	46	EM-EV-CLR-12V	2903246	247
CABLE-FLK20/OE/0,14/ 50	2305826	503	DFLK 16	2280239	530	ELR 1-230AC/600AC-30	2297167	47	EM-MODBUS-GATEWAY-IFS	2901528	14
CABLE-FLK20/OE/0,14/ 100	2305305	503	DFLK 16/FKCT	2903036	531	ELR 3- 24DC/500AC-50	2297183	47	EM-PB-GATEWAY-IFS	2297620	21
CABLE-FLK20/OE/0,14/ 150	2305318	503	DFLK 20	2280242	530	ELR 2+1- 24DC/500AC-37	2297277	41	EM-RS232-GATEWAY-IFS	2901526	14
CABLE-FLK20/OE/0,14/ 200	2305321	503	DFLK 20/FKCT	2903038	531	ELR 2+1-230AC/500AC-37	2297280	41	EM-RS485-GATEWAY-IFS	2901527	14
CABLE-FLK20/OE/0,14/ 250	2305334	503	DFLK 26	2280255	530	ELR 3- 24DC/500AC- 2	2297196	40	EMD-BL-3V-400	2903525	251
CABLE-FLK20/OE/0,14/ 300	2305347	503	DFLK 26/FKCT	2903039	531	ELR 3- 24DC/500AC- 9	2297219	41	EMD-BL-3V-400-PT	2903526	251
CABLE-FLK20/OE/0,14/ 400	2305839	503	DFLK 34	2280268	530	ELR 3- 24DC/500AC-16	2297235	41	EMD-BL-C-10	2903521	250
CABLE-FLK20/OE/0,14/ 600	2305842	503	DFLK 34/FKCT	2903041	531	ELR 3-230AC/500AC- 2	2297206	40	EMD-BL-C-10-PT	2903522	250
CABLE-FLK20/OE/0,14/ 800	2305855	503	DFLK 40	2280271	530	ELR 3-230AC/500AC- 9	2297222	41	EMD-BL-PH-480	2903527	251
CABLE-FLK20/OE/0,14/...	2305745	503	DFLK 40/FKCT	2903042	531	ELR 3-230AC/500AC-16	2297248	41	EMD-BL-PH-480-PT	2903528	251
CABLE-FLK20/OE/0,14/1000	2305868	503	DFLK 50	2280284	530	ELR 5011 IP PN	2700745	48	EMD-BL-V-230	2903523	250
CABLE-FLK50/0,14/HF/ 0,5M	2314134	505	DFLK 50/FKCT	2903043	531	ELR 5011-2 IP PN	2701007	48	EMD-BL-V-230-PT	2903524	250
CABLE-FLK50/0,14/HF/ 1,0M	2314147	505	DFLK-D 9 SUB/B	2287135	537	ELR 5030 IP PN	2701006	49	EMD-FL-3V-230	2885773	254
CABLE-FLK50/0,14/HF/ 1,5M	2314150	505	DFLK-D 9 SUB/FKCT	2903063	538	ELR 5030-2 IP PN	2701008	49	EMD-FL-3V-400	2866064	254
CABLE-FLK50/0,14/HF/ 2,0M	2314163	505	DFLK-D 9 SUB/M/FKCT	2903052	538	ELR H3-I-SC- 24DC/500AC-0,6	2900542	24	EMD-FL-3V-500	2867979	255
CABLE-FLK50/0,14/HF/ 2,5M	2314176	505	DFLK-D 9 SUB/S	2283870	537	ELR H3-I-SC- 24DC/500AC-2	2900543	24	EMD-FL-3V-690	2885249	255
CABLE-FLK50/0,14/HF/ 3,0M	2314189	505	DFLK-D15 SUB/B	2280307	537	ELR H3-I-SC- 24DC/500AC-9	2900545	25	EMD-FL-C-10	2866022	252
CABLE-FLK50/0,14/HF/ 4,0M	2314192	505	DFLK-D15 SUB/FKCT	2903065	538	ELR H3-I-SC-230AC/500AC-0,6	2900685	24	EMD-FL-PF-400	2885809	256
CABLE-FLK50/0,14/HF/ 5,0M	2314202	505	DFLK-D15 SUB/M/FKCT	2903054	538	ELR H3-I-SC-230AC/500AC-2	2900544	24	EMD-FL-RP-480	2900177	256
CABLE-FLK50/0,14/HF/ 6,0M	2314215	505	DFLK-D15 SUB/S	2280297	537	ELR H3-I-SC-230AC/500AC-9	2900546	25	EMD-FL-V-300	2866048	253
CABLE-FLK50/0,14/HF/ 7,0M	2314228	505	DFLK-D25 SUB/B	2280323	537	ELR H3-IES-PT-24DC/500AC-0,6	2903914	20	EMD-SL-3V-400	2866051	255
CABLE-FLK50/0,14/HF/ 8,0M	2314231	505	DFLK-D25 SUB/FKCT	2903067	538	ELR H3-IES-PT-24DC/500AC-2	2903916	20	EMD-SL-3V-400-N	2885278	255
CABLE-FLK50/0,14/HF/10,0M	2314244	505	DFLK-D25 SUB/M/FKCT	2903055	538	ELR H3-IES-PT-24DC/500AC-9	2903918	21	EMD-SL-C-OC-10	2866019	252
CABLE-FLK50/OE/0,14/ 50	2305871	503	DFLK-D25 SUB/S	2280310	537	ELR H3-IES-SC- 24DC/500AC-0,6	2900566	20	EMD-SL-C-UC-10	2867937	252
CABLE-FLK50/OE/0,14/ 100	2305350	503	DFLK-D37 SUB/B	2280349	537	ELR H3-IES-SC- 24DC/500AC-2	2900567	20	EMD-SL-LL-110	2901137	257
CABLE-FLK50/OE/0,14/ 150	2305363	503	DFLK-D37 SUB/FKCT	2903069	538	ELR H3-IES-SC- 24DC/500AC-9	2900569	21	EMD-SL-LL-230	2885906	257
CABLE-FLK50/OE/0,14/ 200	2305897	503	DFLK-D37 SUB/M/FKCT	2903056	538	ELR H3-IES-SC-230AC/500AC-0,6	2900689	20	EMD-SL-PH-400	2866077	255
CABLE-FLK50/OE/0,14/ 250	2305389	503	DFLK-D37 SUB/S	2280336	537	ELR H3-IES-SC-230AC/500AC-2	2900568	20	EMD-SL-PS- 24AC	2866103	252
CABLE-FLK50/OE/0,14/ 300	2305392	503	DFLK-D50 SUB/B	2287669	537	ELR H3-IES-SC-230AC/500AC-9	2900570	21	EMD-SL-PS- 24DC	2885359	252
CABLE-FLK50/OE/0,14/ 400	2305884	503	DFLK-D50 SUB/FKCT	2903070	538	ELR H3-SC- 24DC/500AC-9	2900530	27	EMD-SL-PS-110AC	2866116	252
CABLE-FLK50/OE/0,14/ 600	2305897	503	DFLK-D50 SUB/M/FKCT	2903058	538	ELR H3-SC-230AC/500AC-9	2900531	27	EMD-SL-PS-120AC	2885731	252
CABLE-FLK50/OE/0,14/ 800	2305907	503	DFLK-D50 SUB/S	2291286	537	ELR H5-I-SC- 24DC/500AC-0,6	2900573	22	EMD-SL-PS-230AC	2866129	252
CABLE-FLK50/OE/0,14/...	2305758	503	DIKD 1,5	2715979	399	ELR H5-I-SC- 24DC/500AC-2	2900574	22	EMD-SL-PS45-110AC	2885281	255
CABLE-FLK50/OE/0,14/1000	2305910	503				ELR H5-I-SC- 24DC/500AC-9	2900576	23	EMD-SL-PS45-120AC	2885744	255
CLIPFIX 35	3022218	318				ELR H5-I-SC-230AC/500AC-0,6	2900691	22	EMD-SL-PS45-230AC	2885294	255
CM-KBL-RS232/USB	2881078	149				ELR H5-I-SC-230AC/500AC-2	2900575	22	EMD-SL-PS45-400AC	2885304	255
						ELR H5-I-SC-230AC/500AC-9	2900578	23	EMD-SL-PS45-500AC	2885317	256
						ELR H5-IES-PT-24DC/500AC-0,6	2903902	18	EMD-SL-PTC	2866093	257
						ELR H5-IES-PT-24DC/500AC-2	2903904	18	EMD-SL-V-UV-300	2866035	253
						ELR H5-IES-PT-24DC/500AC-9	2903906	19	EMG 17-OV- 24DC/ 48DC/2	2942810	405
						ELR H5-IES-SC- 24DC/500AC-0,6	2900582	18	EMG 17-REL/KSR-G 24/2E/SO38	2941646	407
						ELR H5-IES-SC- 24DC/500AC-2	2900414	18	EMG 17-REL/KSR-G 24/SO38 BK	2949994	407
						ELR H5-IES-SC- 24DC/500AC-9	2900421	19	EMG 22-DIO 4E	2950048	262
						ELR H5-IES-SC-230AC/500AC-0,6	2900692	18	EMG 22-DIO 4E-1N5408	2952790	262
						ELR H5-IES-SC-230AC/500AC-2	2900420	18	EMG 22-DIO 4M-1N5408	2952211	262
						ELR H5-IES-SC-230AC/500AC-9	2900422	19	EMG 22-DIO 4P-1N5408	2952198	262
						ELR H5-IES-SC-SWD/500AC-0,6	2903116	31	EMG 22-DIO 7M	2950077	262
						ELR H5-IES-SC-SWD/500AC-2	2903117	31	EMG 22-DIO 7P	2950064	262
						ELR H5-IES-SC-SWD/500AC-9	2903118	31	EMG 22-LA 7S/230	2949677	263
						ELR H5-SC- 24DC/500AC-9	2900538	26	EMG 22-LED 7S/24	2952305	263
						ELR H5-SC-230AC/500AC-9	2900539	26	EMG 22-REL/KSR-230/21/ SO46	2940760	404
						ELR H51-0,6-DIN-RAIL-SET	2902952	29	EMG 22-REL/KSR-230/21/AU/SO46	2940061	404
						ELR H51-2-4-DIN-RAIL-SET	2902953	29	EMG 22-REL/KSR-G 24/TRN 5	2949787	414
						ELR H51-9-DIN-RAIL-SET	2902954	29	EMG 22-REL/KSR-G 24/TRN12	2952363	414
						ELR H51-IESSC-24DC500AC-06	2902746	29	EMG 22-REL/KSR-G 24/TRN35	2952350	414
						ELR H51-IESSC-24DC500AC-2	2902744	29	EMG 22-REL/KSR-G 24/TRP 5	2949790	415
						ELR H51-IESSC-24DC500AC-9	2902745	29	EMG 22-REL/KSR-G 24/TRP12	2952156	415
						ELR H51-IMP-MA400	2963598	44	EMG 22-REL/KSR-G 24/TRP35	2952169	415
						ELR H51-IMP-MA600	2982090	44	EMG 30-SP- 4K7LIN	2940252	148
						ELR W1/ 6-24DC	2297374	39	EMG 30-SP-10K LIN	2942124	148
						ELR W2+1- 24DC/500AC-37	2297387	39	EMG 45-DIO 8E	2950103	262
						ELR W2+1-230AC/500AC-37	2297293	38	EMG 45-DIO 8E-1N5408	2949389	262
						ELR W3- 24DC/500AC- 2	2297031	38	EMG 45-DIO 8E/LP		

Type	Order No.	Page	Type	Order No.	Page	Type	Order No.	Page	Type	Order No.	Page
EMG 45-DIO 8P-1N5408	2954879	262	FBST 500-PLC GY	2966838	368	FLK 16/14/DV-IN/200	2300562	432	FLK 40/4X14/EZ-DR/ 200/OB32	2298522	431
EMG 45-DIO14M	2950129	262	FBST 500-PLC RD	2966786	368	FLK 16/14/DV-IN/300	2304403	432	FLK 40/4X14/EZ-DR/ 300/OB32	2296841	431
EMG 45-DIO14M/LP	2950132	263	FLK CRIMPTOOL	2744869	48	FLK 16/14/DV-IN/400	2305185	432	FLK 40/4X14/EZ-DR/ 300/OB32	2298535	431
EMG 45-DIO14P	2950116	262	FL PLUG RJ45 GN/2	2744571	48	FLK 16/14/DV-OUT/ 30	2304348	432	FLK 40/EZ-DR/ 50/KONFEK	2288985	507
EMG 45-LED 14S/24	2952334	263	FL PLUG RJ45 GR/2	2744856	48	FLK 16/14/DV-OUT/ 50	2304351	432	FLK 40/EZ-DR/ 50/SLC	2294610	430
EMG 90-DIO 16E/LP	2954808	263	FLK 10/EZ-DR/ 50/KONFEK	2299204	506	FLK 16/14/DV-OUT/100	2300575	432	FLK 40/EZ-DR/ 100/KONFEK	2288998	430
EMG 90-DIO 17E	2954895	262	FLK 10/EZ-DR/ 100/KONFEK	2299217	506	FLK 16/14/DV-OUT/200	2300588	432	FLK 40/EZ-DR/ 100/SLC	2294623	507
EMG 90-DIO 32M	2954934	262	FLK 10/EZ-DR/ 150/KONFEK	2299220	506	FLK 16/14/DV-OUT/300	2304364	432	FLK 40/EZ-DR/ 150/KONFEK	2289007	507
EMG 90-DIO 32M/LP	2954785	263	FLK 10/EZ-DR/ 200/KONFEK	2299233	506	FLK 16/24/DV-AI/EZ-DR/ 30	2304319	432	FLK 40/EZ-DR/ 150/SLC	2294636	430
EMG 90-DIO 32P	2954918	262	FLK 10/EZ-DR/ 300/KONFEK	2299246	506	FLK 16/24/DV-AI/EZ-DR/ 50	2304296	432	FLK 40/EZ-DR/ 200/KONFEK	2298010	507
EMG-GKS 12	2947035	262	FLK 10/EZ-DR/ 400/KONFEK	2299259	506	FLK 16/24/DV-AI/EZ-DR/100	2301134	432	FLK 40/EZ-DR/ 200/SLC	2294649	430
EML (15X6) R YE	0819288	372	FLK 10/EZ-DR/ 600/KONFEK	2299262	506	FLK 16/24/DV-AI/EZ-DR/200	2301545	432	FLK 40/EZ-DR/ 250/KONFEK	2289023	507
EMM 3- 24DC/500AC-16-IFS	2297523	12	FLK 10/EZ-DR/ 800/KONFEK	2299275	506	FLK 16/24/DV-AI/EZ-DR/300	2304322	432	FLK 40/EZ-DR/ 300/KONFEK	2289036	507
EMM 3- 24DC/500AC-IFS	2297497	12	FLK 10/EZ-DR/1000/KONFEK	2299288	506	FLK 16/EZ-DR/ 50/KONFEK	2299291	506	FLK 40/EZ-DR/ 300/SLC	2294652	430
EMM 3-230AC/500AC-16-IFS	2297536	12	FLK 14-16-EZ-DR-HF-S7/...	2295693	457	FLK 16/EZ-DR/ 100/KONFEK	2299301	506	FLK 40/EZ-DR/ 350/KONFEK	2289049	507
EMM 3-230AC/500AC-IFS	2297507	12	FLK 14/16/EZ-DR/ 50/S7	2293815	456	FLK 16/EZ-DR/ 150/KONFEK	2299314	506	FLK 40/EZ-DR/ 400/KONFEK	2289052	507
ETD-BL-1T-F- 10S	2917492	259	FLK 14/16/EZ-DR/ 100/S7	2293828	456	FLK 16/EZ-DR/ 200/KONFEK	2299327	506	FLK 40/EZ-DR/ 600/KONFEK	2299589	507
ETD-BL-1T-F- 10S-PT	2901489	259	FLK 14/16/EZ-DR/ 100/S7	2293831	456	FLK 16/EZ-DR/ 300/KONFEK	2299330	506	FLK 40/EZ-DR/ 800/KONFEK	2299592	507
ETD-BL-1T-F- 30MIN	2917515	259	FLK 14/16/EZ-DR/ 200/S7	2293844	456	FLK 16/EZ-DR/ 400/KONFEK	2299343	506	FLK 40/EZ-DR/1000/KONFEK	2299602	507
ETD-BL-1T-F- 30MIN-PT	2901491	259	FLK 14/16/EZ-DR/ 250/S7	2293857	456	FLK 16/EZ-DR/ 600/KONFEK	2299356	506	FLK 50-2FLK20-EZ-DR-DV/...	2304966	432
ETD-BL-1T-F-300MIN	2917528	259	FLK 14/16/EZ-DR/ 300/S7	2293860	456	FLK 16/EZ-DR/ 800/KONFEK	2299369	506	FLK 50-4X14-EZ-DR ...	2302405	508
ETD-BL-1T-F-300MIN-PT	2901492	259	FLK 14/16/EZ-DR/ 400/S7	2293863	456	FLK 16/EZ-DR/1000/KONFEK	2299372	506	FLK 50-EZ-DR/ FCN40-OMR-OU/...	2302447	508
ETD-BL-1T-F-300S	2917502	259	FLK 14/16/EZ-DR/ 500/S7	2293869	456	FLK 20/2FLK14/EZ-DR/...	2304487	432	FLK 50-EZ-DR-D37SUB-X81-I/...	2302683	440
ETD-BL-1T-F-300S-PT	2901490	259	FLK 14/16/EZ-DR/ 600/S7	2293890	456	FLK 20/2FLK14/EZ-DR/100/KONFEK	2298470	432	FLK 50-EZ-DR-D37SUB-Y81P-O/...	2302625	440
ETD-BL-1T-OFF-CC- 10S	2917450	259	FLK 14/16/EZ-DR/ 700/S7	2293912	456	FLK 20/2FLK14/EZ-DR/200/KONFEK	2298438	432	FLK 50-EZ-DR-FCN40-OMR-IN/...	2302803	442
ETD-BL-1T-OFF-CC- 10S-PT	2901485	259	FLK 14/16/EZ-DR/ 800/S7	2293925	456	FLK 20/2FLK14/EZ-DR/300/KONFEK	2300818	432	FLK 50-EZ-DR-FCN40-OMR-OU/...	2302829	442
ETD-BL-1T-OFF-CC- 30MIN	2917467	259	FLK 14/16/EZ-DR/ 900/S7	2293938	456	FLK 20/EZ-DR/ 50/KONFEK	2296391	506	FLK 50-PA/EZ-DR/KS/ 200/YUC	2314299	466
ETD-BL-1T-OFF-CC- 30MIN-PT	2901487	259	FLK 14/16/EZ-DR/1000/S7	2293941	456	FLK 20/EZ-DR/ 100/KONFEK	2296401	506	FLK 50-PA/EZ-DR/KS/ 300/YUC	2314309	466
ETD-BL-1T-OFF-CC-300MIN	2917489	259	FLK 14/16/EZ-DR/HF/ 50/S7	2296919	457	FLK 20/EZ-DR/ 150/KONFEK	2296472	506	FLK 50-PA/EZ-DR/KS/ 400/YUC	2314312	466
ETD-BL-1T-OFF-CC-300MIN-PT	2901488	259	FLK 14/16/EZ-DR/HF/ 100/S7	2296922	457	FLK 20/EZ-DR/ 200/KONFEK	2296485	506	FLK 50-PA/EZ-DR/KS/ 500/YUC	2321499	466
ETD-BL-1T-OFF-CC-300S	2917463	259	FLK 14/16/EZ-DR/HF/ 150/S7	2296935	457	FLK 20/EZ-DR/ 300/KONFEK	2296498	506	FLK 50-PA/EZ-DR/KS/ 600/YUC	2314927	466
ETD-BL-1T-OFF-CC-300S-PT	2901486	259	FLK 14/16/EZ-DR/HF/ 200/S7	2296948	457	FLK 20/EZ-DR/ 400/KONFEK	2296508	506	FLK 50-PA/EZ-DR/KS/ 700/YUC	2321509	466
ETD-BL-1T-ON- 10S	2917379	258	FLK 14/16/EZ-DR/HF/ 250/S7	2296951	457	FLK 20/EZ-DR/ 600/KONFEK	2296511	506	FLK 50-PA/EZ-DR/KS/ 800/YUC	2314930	466
ETD-BL-1T-ON- 10S-PT	2901476	258	FLK 14/16/EZ-DR/HF/ 300/S7	2296964	457	FLK 20/EZ-DR/ 800/KONFEK	2296524	506	FLK 50-PA/EZ-DR/KS/ 900/YUC	2321512	466
ETD-BL-1T-ON- 30MIN	2917395	258	FLK 14/16/EZ-DR/HF/ 400/S7	2904525	457	FLK 20/EZ-DR/1000/KONFEK	2296537	506	FLK 50-PA/EZ-DR/KS/1000/YUC	2314325	466
ETD-BL-1T-ON- 30MIN-PT	2901478	258	FLK 14/16/EZ-DR/HF/ 500/S7	2304704	457	FLK 26/EZ-DR/ 50/KONFEK	2299385	506	FLK 50-PA/EZ-DR/KS/1100/YUC	2321389	466
ETD-BL-1T-ON-300MIN	2917405	258	FLK 14/16/EZ-DR/HF/ 600/S7	2904526	457	FLK 26/EZ-DR/ 100/KONFEK	2299398	506	FLK 50-PA/EZ-DR/KS/1200/YUC	2321525	466
ETD-BL-1T-ON-300MIN-PT	2901479	258	FLK 14/16/EZ-DR/HF/ 800/S7	2904527	457	FLK 26/EZ-DR/ 150/KONFEK	2299408	506	FLK 50-PA/EZ-DR/KS/1300/YUC	2321392	466
ETD-BL-1T-ON-300S	2917382	258	FLK 14/16/EZ-DR/HF/1000/S7	2904528	457	FLK 26/EZ-DR/ 200/KONFEK	2299411	506	FLK 50-PA/EZ-DR/KS/1400/YUC	2321402	466
ETD-BL-1T-ON-300S-PT	2901477	258	FLK 14/EZ-DR/ 30/KONFEK	2295729	504	FLK 26/EZ-DR/ 300/KONFEK	2299424	506	FLK 50-PA/EZ-DR/KS/1500/YUC	2314338	466
ETD-BL-1T-ON-CC- 10S	2917418	259	FLK 14/EZ-DR/ 50/KONFEK	2288901	504	FLK 26/EZ-DR/ 400/KONFEK	2299437	506	FLK 50-PA/EZ-DR/KS/1600/YUC	2321538	466
ETD-BL-1T-ON-CC- 10S-PT	2901480	259	FLK 14/EZ-DR/ 50/KONFEK/S	2296977	505	FLK 26/EZ-DR/ 600/KONFEK	2299440	506	FLK 50-PA/EZ-DR/KS/1700/YUC	2321541	466
ETD-BL-1T-ON-CC- 30MIN	2917434	259	FLK 14/EZ-DR/ 100/KONFEK	2288914	504	FLK 26/EZ-DR/ 800/KONFEK	2299453	506	FLK 50-PA/EZ-DR/KS/1800/YUC	2321554	466
ETD-BL-1T-ON-CC- 30MIN-PT	2901483	259	FLK 14/EZ-DR/ 100/KONFEK/S	2296980	505	FLK 26/EZ-DR/1000/KONFEK	2299466	506	FLK 50-PA/EZ-DR/KS/1900/YUC	2321567	466
ETD-BL-1T-ON-CC-300MIN	2917447	259	FLK 14/EZ-DR/ 150/KONFEK	2288927	504	FLK 34/EZ-DR/ 50/KONFEK	2299479	506	FLK 50-PA/EZ-DR/KS/2000/YUC	2314503	466
ETD-BL-1T-ON-CC-300MIN-PT	2901484	259	FLK 14/EZ-DR/ 150/KONFEK/S	2296993	505	FLK 34/EZ-DR/ 100/KONFEK	2299482	506	FLK 50-PA/EZ-DR/KS/2500/YUC	2314516	466
ETD-BL-1T-ON-CC-300S	2917421	259	FLK 14/EZ-DR/ 200/KONFEK	2288930	504	FLK 40-PA/EZ-DR/KS/ 100/YUC	2299495	506	FLK 50-PA/EZ-DR/KS/3000/YUC	2314529	466
ETD-BL-1T-ON-CC-300S-PT	2901481	259	FLK 14/EZ-DR/ 200/KONFEK/S	2297002	505	FLK 40-PA/EZ-DR/KS/ 200/YUC	2299505	506	FLK 50-PA/EZ-DR/KS/3000/YUC	2314529	466
ETD-FL-2T-DTI	2866187	260	FLK 14/EZ-DR/ 250/KONFEK	2288943	504	FLK 34/EZ-DR/ 300/KONFEK	2299518	506	FLK 50/2FLK20/EZ-DR/ 100/DV	2304898	432
ETD-SL-1T-DTF	2866161	261	FLK 14/EZ-DR/ 300/KONFEK	2288956	504	FLK 34/EZ-DR/ 400/KONFEK	2299521	506	FLK 50/2FLK20/EZ-DR/ 200/DV	2304908	432
ETD-SL-2T-I	2866174	261	FLK 14/EZ-DR/ 300/KONFEK/S	2299013	505	FLK 34/EZ-DR/ 600/KONFEK	2299534	506	FLK 50/2FLK20/EZ-DR/ 300/DV	2304911	432
EU4A-RJ45-USB-CAB1 PXC	2903465	34	FLK 14/EZ-DR/ 350/KONFEK	2288969	504	FLK 34/EZ-DR/ 800/KONFEK	2299547	506	FLK 50/2FLK20/EZ-DR/ 600/DV	2304937	432
EU5C-SWD-CAN PXC	2903098	33	FLK 14/EZ-DR/ 400/KONFEK	2288972	504	FLK 34/EZ-DR/1000/KONFEK	2299550	506	FLK 50/2FLK20/EZ-DR/ 800/DV	2304940	432
EU5C-SWD-DP PXC	2903100	33	FLK 14/EZ-DR/ 400/KONFEK/S	2299026	505	FLK 40-PA/EZ-DR/KS/ 100/YUC	2322786	466	FLK 50/2FLK20/EZ-DR/1000/DV	2304953	432
EU5C-SWD-EIP-MODTCP PXC	2903244	33	FLK 14/EZ-DR/ 450/KONFEK	2290847	504	FLK 40-PA/EZ-DR/KS/ 200/YUC	2314341	466	FLK 50/4X14/EZ-DR/ 50/KONFEK	2296689	508
EU5C-SWD-PF2-1 PXC	2903113	33	FLK 14/EZ-DR/ 500/KONFEK	2290834	504	FLK 40-PA/EZ-DR/KS/ 300/YUC	2314354	466	FLK 50/4X14/EZ-DR/ 100/KONFEK	2296692	508
EU5E-SWD-2A2A PXC	2903104	33	FLK 14/EZ-DR/ 550/KONFEK	2290850	504	FLK 40-PA/EZ-DR/KS/ 400/YUC	2314367	466	FLK 50/4X14/EZ-DR/ 150/KONFEK	2296702	508
EU5E-SWD-4D4D PXC	2903101	33	FLK 14/EZ-DR/ 600/KONFEK	2290863	504	FLK 40-PA/EZ-DR/KS/ 500/YUC	2321570	466	FLK 50/4X14/EZ-DR/ 200/KONFEK	2296715	508
EU5E-SWD-4DX PXC	2903102	33	FLK 14/EZ-DR/ 600/KONFEK/S	2299039	505	FLK 40-PA/EZ-DR/KS/ 600/YUC	2314943	466	FLK 50/4X14/EZ-DR/ 250/KONFEK	2305402	508
EU5E-SWD-X8D PXC	2903103	33	FLK 14/EZ-DR/ 800/KONFEK	2299563	504	FLK 40-PA/EZ-DR/KS/ 700/YUC	2321583	466	FLK 50/4X14/EZ-DR/ 300/KONFEK	2296728	508
F			FLK 14/EZ-DR/ 800/KONFEK/S	2299042	505	FLK 40-PA/EZ-DR/KS/ 800/YUC	2314956	466	FLK 50/4X14/EZ-DR/ 400/KONFEK	2296731	508
FBS 2-6	3030336	318	FLK 14/EZ-DR/1000/KONFEK	2299576	504	FLK 40-PA/EZ-DR/KS/ 900/YUC	2321415	466	FLK 50/4X14/EZ-DR/ 600/KONFEK	2296744	508
FBS 2-6 BU	3036932	318	FLK 14/EZ-DR/1000/KONFEK/S	2299055	505	FLK 40-PA/EZ-DR/KS/1000/YUC	2314370	466	FLK 50/4X14/EZ-DR/ 800/KONFEK	2296757	508
FBS 2-6 GY	3032237	318	FLK 14/EZ-DR/HF/ 50/KONFEK	2305952	505	FLK 40-PA/EZ-DR/KS/1100/YUC	2321428	466	FLK 50/EZ-DR/ 50/KONFEK	2289065	504
FBS 2-8	3030284	318	FLK 14/EZ-DR/HF/ 100/KONFEK	2305965	505	FLK 40-PA/EZ-DR/KS/1200/YUC	2321431	466			

Type	Order No.	Page	Type	Order No.	Page	Type	Order No.	Page	Type	Order No.	Page
FLK 50/EZ-DR/550/KONFEK	2289599	504	FLKM S135-431-4UA/S400	2314846	459	LV- 12- 24UC	2833712	388	MACX MCR-SL-NAM-R-SP	2924252	120
FLK 50/EZ-DR/600/KONFEK	2289609	504	FLKM S135-454-4UA/S400	2314859	461	LV- 48- 60UC	2833725	388	MACX MCR-SL-RPSSI-2I	2924825	107
FLK 50/EZ-DR/800/KONFEK/S	2289152	505	FLKM S135-460-4UA/I/S400	2314613	461	LV-120-230AC/110DC	2833738	388	MACX MCR-SL-RPSSI-2I-SP	2924838	107
FLK 50/EZ-DR/850/KONFEK	2289612	504	FLKM S135-460-4UA/U/S400	2314862	461	LV3- 12- 24UC	2833835	388	MACX MCR-SL-RPSSI-I	2865955	106
FLK 50/EZ-DR/700/KONFEK	2289625	504	FLKM S135-465-4UA/T/S400	2314875	462	LV3- 48- 60UC	2833848	388	MACX MCR-SL-RPSSI-I-SP	2924207	106
FLK 50/EZ-DR/750/KONFEK	2289638	504	FLKM S135-465-4UA/UIS400	2314888	462	LV3-120-230AC/110DC	2833851	388	MACX MCR-SL-RPSSI-I-UP	2865968	108
FLK 50/EZ-DR/800/KONFEK	2289641	504	FLKM S135-470-4UC/I/S400	2314626	462				MACX MCR-SL-RPSSI-I-UP-SP	2924210	108
FLK 50/EZ-DR/800/KONFEK/S	2289165	505	FLKM S135-470-4UC/U/S400	2314891	462				MACX MCR-SL-RTD-I	2865065	110
FLK 50/EZ-DR/850/KONFEK	2289654	504	FLKM S135/42X0,75/3,0M/OE	2315007	463				MACX MCR-SL-RTD-I-NC	2865078	110
FLK 50/EZ-DR/900/KONFEK	2289667	504	FLKM S135/42X0,75/5,0M/OE	2318017	463				MACX MCR-SL-RTD-I-SP	2924317	110
FLK 50/EZ-DR/950/KONFEK	2289670	504	FLKM S135/S400/SO120	2301723	459				MACX MCR-SL-RTD-I-SP-NC	2924320	110
FLK 50/EZ-DR/1000/KONFEK	2289683	504	FLKM S135/S400/SO121	2301736	459				MACX MCR-SL-TC-I	2924333	112
FLK 50/EZ-DR/1000/KONFEK/S	2289178	505	FLKM S135/S400/SO122	2301749	459	MACX MCR-EX-SL-2NAM-R-UP	2865984	175	MACX MCR-SL-TC-I-NC	2924346	112
FLK 50/EZ-DR/D37SUB/50/X81-I	2302641	440	FLKM S135/S400/SO123	2301752	460	MACX MCR-EX-SL-2NAM-R-UP-SP	2924249	175	MACX MCR-T-UI-UP	2811394	114
FLK 50/EZ-DR/D37SUB/50/Y81P-O	2302599	440	FLKM S135/S400/SO124	2301765	461	MACX MCR-EX-SL-2NAM-RO	2865476	174	MACX MCR-T-UI-UP-C	2811873	114
FLK 50/EZ-DR/D37SUB/100/X81-I	2302654	440	FLKM S135/S400/SO125	2301778	460	MACX MCR-EX-SL-2NAM-RO-SP	2924087	174	MACX MCR-T-UI-UP-SP	2811860	114
FLK 50/EZ-DR/D37SUB/100/Y81P-O	2302609	440	FLKM S135/S400/SO126	2301781	460	MACX MCR-EX-SL-2NAM-T	2865489	177	MACX MCR-T-UI-UP-SP-C	2811970	114
FLK 50/EZ-DR/D37SUB/200/X81-I	2302667	440	FLKM S135/S400/SO127	2301794	460	MACX MCR-EX-SL-2NAM-T-SP	2924090	177	MACX MCR-T-UIREL-UP	2811378	116
FLK 50/EZ-DR/D37SUB/200/Y81P-O	2302612	440	FLKM S135/S7/FLK50/PLC	2314736	463	MACX MCR-EX-SL-IDSH-I	2865405	164	MACX MCR-T-UIREL-UP-C	2811514	116
FLK 50/EZ-DR/D37SUB/300/X81-I	2302670	440	FLKM-2FLK14/KDS3-MT/PPA/S7	2295062	482	MACX MCR-EX-SL-IDSH-SP	2924032	164	MACX MCR-T-UIREL-UP-SP	2811828	116
FLK 50/EZ-DR/D37SUB/300/Y81P-O	2302638	440	FLKM-D25 SUB/B/KDS3-MT/TU810	2304513	422	MACX MCR-EX-SL-NAM-2RO	2865450	173	MACX MCR-T-UIREL-UP-SP-C	2811831	116
FLK 50/EZ-DR/FCN40/100/OMR-IN	2302641	442	FLKM-D25 SUB/B/KDS3-MT/TU810/P	2304539	422	MACX MCR-EX-SL-2NAM-2RO-SP	2924061	173	MACX MCR-T-UI-UP	2811284	102
FLK 50/EZ-DR/FCN40/100/OMR-OUT	2304144	442	FLKM-D25 SUB/B/KDS3-MT/TU830	2304526	422	MACX MCR-EX-SL-NAM-2T	2865463	176	MACX MCR-T-UI-UP-NC	2811446	102
FLK 50/EZ-DR/FCN40/200/OMR-IN	2304173	442	FLKM-KS40/AO16/YCS	2314260	469	MACX MCR-EX-SL-NAM-2T-SP	2924074	176	MACX MCR-T-UI-UP	2811572	102
FLK 50/EZ-DR/FCN40/200/OMR-OUT	2304157	442	FLKM-KS40/YCS	2314642	468	MACX MCR-EX-SL-NAM-NAM	2866006	178	MACX MCR-T-UI-UP-SP-NC	2811556	102
FLK EZ-DR-S-.../.../...	2295046	456	FLKM-PA-2D15/HW/DI/C300	2301879	438	MACX MCR-EX-SL-NAM-NAM-SP	2924883	178	MACX MCR-T-UI-UP	2811459	104
FLK EZ-DR-S-.../.../...	2295059	456	FLKM-PA-2D15/HW/DO/C300	2900924	438	MACX MCR-EX-SL-NAM-R	2865434	172	MACX MCR-T-UI-UP-NC	2811297	104
FLKM 14-PA-AB/1756/EXTC	2302861	425	FLKM-PA-D37/HW/AN/C300	2900622	438	MACX MCR-EX-SL-NAM-R-SP	2924045	172	MACX MCR-T-UI-UP-SP	2811585	104
FLKM 14-PA-AB/1756/IF6/EXTC	2901037	425	FLKM-PA-D37/HW/DIO/C300	2901423	438	MACX MCR-EX-SL-RPSSI-2I-2I	2865382	162	MACX MCR-T-UI-UP-SP-NC	2811569	104
FLKM 14-PA-AB/1756/IN/EXTC	2302874	425	FLKMS 50/32IM/LA/PLC	2284510	480	MACX MCR-EX-SL-RPSSI-2I-2I-SP	2924676	162	MC 1,5/5-ST-3,81	1803804	12
FLKM 14-PA-INLINE/32	2302777	444	FLKMS 50/32IM/PLC	2284523	480	MACX MCR-EX-SL-RPSSI-2I	2865366	161	MCR-1CLP-I-00	2814016	135
FLKM 14-PA-INLINE/DIO8	2900889	444	FLKMS 50/32IM/ZFKDS/PLC	2901389	480	MACX MCR-EX-SL-RPSSI-2I-SP	2924236	161	MCR-2CLP-I-00	2814029	135
FLKM 14-PA-INLINE/IN16	2302751	444	FLKMS-KS40/Al/YCS	2314286	469	MACX MCR-EX-SL-RPSSI-I	2865340	160	MCR-4CLP-I-00	2814045	135
FLKM 14-PA-INLINE/OUT16	2302764	444	FLKMS-KS40/SIA/16/YCS	2314273	469	MACX MCR-EX-SL-RPSSI-I-SP	2924016	160	MCR-C-I-00-DC	2814508	131
FLKM 14-PA-MODI/M340	2903208	446	FLKMS-KS50/32IM/YCS	2314451	468	MACX MCR-EX-SL-RPSSI-I-UP	2865793	163	MCR-C-I-U- 4-DC	2814511	131
FLKM 14-PA-S300	2289770	451	FUSE-10X38-16A-GR	2903126	29	MACX MCR-EX-SL-RPSSI-I-UP-SP	2924029	163	MCR-C-U-I- 4-DC	2814537	131
FLKM 14-PA-SLC500/IN	2293462	428	FUSE-10X38-20A-GR	2903384	29	MACX MCR-EX-SL-RTD-I	2865939	165	MCR-C-U-U-DC	2814469	131
FLKM 14-PA-SLC500/IN/M	2293475	428	FUSE-10X38-30A-MR	2903119	29	MACX MCR-EX-SL-RTD-I-NC	2865573	165	MCR-ET 38X35 WH	2814317	149
FLKM 14-PA-SLC500/OUT	2293459	428				MACX MCR-EX-SL-RTD-I-SP	2924142	165	MCR-F-UI-DC	2814605	144
FLKM 14-PA/GE/DI	2289038	437				MACX MCR-EX-SL-RTD-I-SP-NC	2924168	165	MCR-FL-C-UI-2UI-DCI	2814854	132
FLKM 14-PA/GE/DO	2289009	437				MACX MCR-EX-SL-SD-21-25-LP	2865492	180	MCR-FL-C-UI-2UI-DCI-NC	2814867	132
FLKM 14/8M/SI/PLC	2294487	478				MACX MCR-EX-SL-SD-21-25-LP-SP	2924113	180	MCR-FL-HT-T-I	2864529	142
FLKM 14/KDS3-MT/PPA/PLC	2290423	482				MACX MCR-EX-SL-SD-21-40-LP	2865764	181	MCR-FL-HT-T-I-EX	2864532	189
FLKM 16-PA-331-1KF/1/MINI-MCR	2318237	455				MACX MCR-EX-SL-SD-21-40-LP-SP	2924139	181	MCR-FL-HT-TS-I-EX	2864545	188
FLKM 16-PA-332-5HF/1/MINI-MCR	2318240	455	IB IL 24 DI 16-PAC	2861250	207	MACX MCR-EX-SL-SD-21-60-LP	2865515	181	MCR-FL-T-LP-I	2864561	140
FLKM 16-PA-S300/MINI-MCR	2314749	454	IB IL 24 DI 2-PAC	2861221	207	MACX MCR-EX-SL-SD-21-60-LP-SP	2924100	181	MCR-FL-T-LP-I-EX	2864574	187
FLKM 16/AI/VD	2304429	433	IB IL 24 DI 4-PAC	2861234	207	MACX MCR-EX-SL-SD-23-48-LFD	2924867	179	MCR-FL-TS-LP-I-EX	2864587	187
FLKM 16/AO/SI/DV	2304445	433	IB IL 24 DI 8-PAC	2861247	207	MACX MCR-EX-SL-SD-23-48-LFD-SP	2924870	179	MCR-PAC-T-USB	2309000	149
FLKM 16/DI/SI/LA/DV	2304458	433	IB IL 24 FLM-PAC	2736903	50	MACX MCR-EX-SL-SD-24-48-LP	2865609	181	MCR-PSP	2811912	146
FLKM 16/DV	2304432	433	IB IL AI 2/SF-PAC	2861302	207	MACX MCR-EX-SL-SD-24-48-LP-SP	2924126	181	MCR-PSP-DC	2811925	146
FLKM 50-PA-AB/1756/EXTC	2302735	424	IB IL AI 8/SI-PAC	2861661	207	MACX MCR-EX-SL-TC-I	2865942	166	MCR-PT100-I	2810353	138
FLKM 50-PA-AB/1756/IN/EXTC	2302748	424	IB IL AI 8/SF-PAC	2861412	207	MACX MCR-EX-SL-TC-I-NC	2865586	166	MCR-PT100-HDC	2810337	138
FLKM 50-PA-AB/IBN	2289816	426	IB IL DI 8/SO-PAC	2897020	207	MACX MCR-EX-T-UI-UP	2865654	168	MCR-PT100-U	2810340	138
FLKM 50-PA-AB/OBN	2289829	426	IBS IP ID0 MBH -F	2732868	48	MACX MCR-EX-T-UI-UP-C	2811763	168	MCR-PT100-U-DC	2810311	138
FLKM 50-PA-GE/TKFC/RXI	2321473	436	IBS PG SET	2836599	48	MACX MCR-EX-T-UI-UP-SP	2924689	168	MCR-S-1-5-UI-DCI	2814634	230
FLKM 50-PA-GE/TKFC/RX/IN	2321486	436	IBS RBC/F-T/	2740151	50	MACX MCR-EX-T-UI-UP-SP-C	2924692	168	MCR-S-1-5-UI-DCI-NC	2814715	230
FLKM 50-PA-MODI-TSX/Q	2294306	445	IFS-CONFSTICK	2986122	12	MACX MCR-EX-T-UIREL-UP	2865751	170	MCR-S-1-5-UI-SW-DCI	2814650	230
FLKM 50-PA-S300	2294445	450	IFS-CONFSTICK-L	2901103	12	MACX MCR-EX-T-UIREL-UP-C	2865722	170	MCR-S-1-5-UI-SW-DCI-NC	2814731	230
FLKM 50-PA-S300/SO167	2307662	452	IFS-OP-CRADLE	2811886	118	MACX MCR-EX-T-UIREL-UP-SP	2924799	170	MCR-S-10-50-UI-DCI	2814647	230
FLKM 50-PA-S400	2294500	458	IFS-OP-UNIT	2811899	118	MACX MCR-EX-T-UIREL-UP-SP-C	2924809	170	MCR-S-10-50-UI-SW-DCI	2814663	230
FLKM 50-PA-S400(3-48)	2294908	458	IFS-USB-PROG-ADAPTER	2811271	119	MACX MCR-PTB	2865625	126	MCR-S10-50-UI-DCI-NC	2814728	230
FLKM 50-PA-SLC500/OUT/2A	2293446	428	IMC 1,5/ 5-ST-3,81	1857919	12	MACX MCR-PTB-SP	2924184	126	MCR-S10-50-UI-SW-DCI-NC	2814744	230
FLKM 50-PA/DO326/S7-300	2321952	452				MACX MCR-S-MUX	2865599	186	MCR-SL-1CLP-I-00-4KV	2814841	134
FLKM 50/ 4-FLK14/PA-MODI-TSX/Q	2294416	445				MACX MCR-S-MUX-TB	2308124	186	MCR-SL-CUC-100-I	2308027	229
FLKM 50/ 4-FLK14/PA-S400	2294429	458				MACX MCR-SL-2NAM-R-UP	2865052	123	MCR-SL-CUC-100-U	2308108	229
FLKM 50/32M/DV	2304869	434				MACX MCR-SL-2NAM-R-UP-SP	2924304	123	MCR-SL-CUC-200-I	2308030	229
FLKM 50/32M/IN/LA/DV	2304856	434				MACX MCR-SL-2NAM-RO	2865049	122	MCR-SL-CUC-200-U	2308205	229
FLKM 50/32M/PLC	2289719	477				MACX MCR-SL-2NAM-RO-SP	2924294	122	MCR-SL-CUC-300-I	2308043	229
FLKM 50/32M/SI/PLC	2294940	478	LDM- 12- 24DC	2833686	388	MACX MCR-SL-2NAM-T	2865036	125	MCR-SL-CUC-300-U	2308302	229
FLKM 50/32P/PLC	2291121	477	LDM- 48- 60DC	2833699	388	MACX MCR-SL-2NAM-T-SP	2924281	125	MCR-SL-CUC-400-I	2308072	229
FLKM 50/4-FLK14/PA-S300	22896281	450	LDM-110DC	2833709	388	MACX MCR-SL-CAC- 5-I	2810612	232	MCR-SL-CUC-500-I	2308085	229
FLKM 50/KDS3-MT/PPA/AN/PLC	2291587	482	LDM3- 12- 24DC	2833806	388	MACX MCR-SL-CAC- 5-I-UP	2810625	232	MCR-SL-CUC-600-I	2308098	229
FLKM 50/KDS3-MT/PPA/PLC	2290614	482	LDM3- 48- 60DC	2833819	388	MACX MCR-SL-CAC-12-I-UP	2810638	232	MCR-SL-D-RA	2810081	150
FLKM 50/KDS											

Type	Order No.	Page	Type	Order No.	Page	Type	Order No.	Page	Type	Order No.	Page
MCR-SL-S-100-U	2813457	233	MINI MCR-SL-UI-2I	2864794	72	PACT MCR-V2- 3015- 60- 75-5A-1	2276502	214	PACT MCR-V2-8015-105- 500-5A-1	2276269	219
MCR-SL-S-200-I-LP	2813499	233	MINI MCR-SL-UI-2I-NC	2864176	72	PACT MCR-V2- 3015- 60-250-5A-1	2276544	214	PACT MCR-V2-8015-105- 600-5A-1	2276272	219
MCR-SL-S-200-U	2813460	233	MINI MCR-SL-UI-2I-SP	2864804	72	PACT MCR-V2- 4012- 70	2277284	215	PACT MCR-V2-8015-105- 750-5A-1	2276285	219
MCR-SLP-1-5-UI-0	2814359	234	MINI MCR-SL-UI-2I-SP-NC	2864189	72	PACT MCR-V2- 5012- 85	2277297	216	PACT MCR-V2-8015-105- 800-5A-1	2276298	219
MCR-SWS-I	2766478	147	MINI MCR-SL-UI-F	2864082	83	PACT MCR-V2- 6015- 85	2277336	217	PACT MCR-V2-8015-105-1000-5A-1	2276308	219
MCR-SWS-U	2766465	147	MINI MCR-SL-UI-F-SP	2810243	83	PACT MCR-V2- 6040- 96	2277349	218	PACT MCR-V2-8015-105-1000-5A-1	2277721	219
MCR-T-UI	2814090	136	MINI MCR-SL-UI-I-LP-NC	2902829	75	PACT MCR-V2- 6315- 95	2277307	218	PACT MCR-V2-8015-105-1250-5A-1	2276311	219
MCR-T-UI-E	2814113	136	MINI MCR-SL-UI-I-LP-SP-NC	2902830	75	PACT MCR-V2- 8015-105	2277352	219	PACT MCR-V2-8015-105-1500-5A-1	2277734	219
MCR-T-UI-E-NC	2814126	136	MINI MCR-SL-UI-REL	2864480	85	PACT MCR-V2- 8020-105	2277365	219	PACT MCR-V2-8015-105-1600-5A-1	2276324	219
MCR-T-UI-NC	2814100	136	MINI MCR-SL-UI-REL-SP	2864493	85	PACT MCR-V2-10020-129	2277378	220	PACT MCR-V2-8015-105-2000-5A-1	2276337	219
MCR-TTL-RS232	2814391	149	MINI MCR-SL-UI-UI	2864383	66	PACT MCR-V2-10020-129-2500-5A	2276395	220	PACT MCR-V2-8015-105-2500-5A-1	2276340	219
MCR-TTL-RS232-E	2814388	149	MINI MCR-SL-UI-UI-NC	2864150	66	PACT MCR-V2-10036-129	2277381	220	PACT MCR-V2-8020-105-1000-5A-1	2277747	219
MCR-VAC-UI-0-DC	2811103	236	MINI MCR-SL-UI-UI-SP	2864710	66	PACT MCR-V2-10036-129-3000-5A	2276405	220	PACT MCR-V2-8020-105-1500-5A-1	2277750	219
MCR-VDC-UI-B-DC	2811116	236	MINI MCR-SL-UI-UI-SP-NC	2864163	66	PACT MCR-V2-12020-159	2277394	221	PACT MCR-V2-8020-105-2000-5A-1	2276382	219
MCR/PI-CONF-WIN	2814799	149	MINI MCR-SL-V8-FLK 16-A	2811268	94	PACT MCR-V2-12040-159	2277404	221	PACT MCR-V3-60	2277417	222
ME 17,5 TBUS 1,5/ 5-ST-3,81 GN	2709561	91	MINI MCR-TC-UI-NC	2902851	80	PACT MCR-V2-12040-159-4000-5A	2276418	221	PACT-FAST-MNT-W13-L40	2276612	223
ME 22,5 TBUS 1,5/ 5-ST-3,81 GN	2707437	12	MINI-PS-100-240AC/24DC/1,5/EX	2866653	91	PACT MCR-V2-3015- 60- 60-5A-1	2277815	214	PACT-FAST-MNT-W13-L65	2276625	223
ME 6,2 TBUS-2 1,5/5-ST-3,81 GN	2869728	90	MINI-SYS-PS-100-240AC/24DC/1,5	2866983	91	PACT MCR-V2-3015- 60- 75-5A-1	2277828	214	PACT-FAST-MNT-W16-L40	2276638	223
MINI MCR-DKL	2308111	88	MM-CONF-SET	2297992	15	PACT MCR-V2-3015- 60- 80-5A-1	2277831	214	PACT-FAST-MNT-W16-L65	2276641	223
MINI MCR-DKL-LABEL	2810272	88	MP 1	2833631	372	PACT MCR-V2-3015- 60- 100-5A-1	2277064	214	PLC-2RPT-24DC/1	2901639	348
MINI MCR-RTD-UI-NC	2902849	76	MP 2	2833644	378	PACT MCR-V2-3015- 60- 125-5A-1	2277624	214	PLC-2RSC-24DC/ 1	2987309	348
MINI MCR-RTD-UI-SP-NC	2902850	76	MPS-IH BK	0201731	191	PACT MCR-V2-3015- 60- 150-5A-1	2277077	214	PLC-2RSP-24DC/ 1	2987312	348
MINI MCR-SL-1CP-I	2864419	74	MPS-IH BU	0201689	191	PACT MCR-V2-3015- 60- 150-5A-1	2277844	214	PLC-ATP BK	2966841	368
MINI MCR-SL-1CP-I-I-SP	2864749	74	MPS-IH GN	0201702	191	PACT MCR-V2-3015- 60- 200-5A-1	2277637	214	PLC-BP A1-14	2980283	368
MINI MCR-SL-2CP-I	2864655	74	MPS-IH GY	0201728	191	PACT MCR-V2-3015- 60- 200-5A-1	2277857	214	PLC-BPT- 24DC/21RW	2900261	360
MINI MCR-SL-2CP-I-I-SP	2864781	74	MPS-IH RD	0201676	191	PACT MCR-V2-3015- 60- 250-5A-1	2277080	214	PLC-BPT- 24UC/ 1/ACT	2900450	329
MINI MCR-SL-CVS-24-5-10-NC	2902822	87	MPS-IH WH	0201663	191	PACT MCR-V2-3015- 60- 250-5A-1	2277860	214	PLC-BPT-120UC/ 1/SEN/SO46	2900456	335
MINI MCR-SL-CVS-24-5-10-SP-NC	2902823	87	MPS-IH YE	0201692	191	PACT MCR-V2-3015- 60- 300-5A-1	2277640	214	PLC-BPT-120UC/21/SO46	2900453	334
MINI MCR-SL-F-UI-NC	2902832	82	MPS-MT	0201744	191	PACT MCR-V2-3015- 60- 400-5A-1	2277093	214	PLC-BPT-230UC/ 1/SEN/SO46	2900457	335
MINI MCR-SL-F-UI-SP-NC	2902833	82				PACT MCR-V2-3015- 60- 500-5A-1	2277653	214	PLC-BPT-230UC/21/SO46	2900455	334
MINI MCR-SL-FM-RC-NC	2902961	89				PACT MCR-V2-3015- 60- 600-5A-1	2277103	214	PLC-BPT-TTL/1	2900458	356
MINI MCR-SL-FM-RC-SP-NC	2902962	89				PACT MCR-V2-3015- 60- 750-5A-1	2277666	214	PLC-BSC- 24UC/ 1/ACT	2982799	329
MINI MCR-SL-I	2864406	71				PACT MCR-V2-4012- 70- 250-5A-1	2277116	215	PLC-BSC-120UC/ 1/SEN/SO46	2980322	335
MINI MCR-SL-I-I-SP	2864723	71				PACT MCR-V2-4012- 70- 300-5A-1	2277679	215	PLC-BSC-120UC/21-21/SO46	2980416	335
MINI MCR-SL-I-U-0	2813541	71	O			PACT MCR-V2-4012- 70- 400-5A-1	2277129	215	PLC-BSC-120UC/21/SO46	2980319	335
MINI MCR-SL-I-U-0-SP	2813554	71	OPT- 5DC/ 24DC/ 2	2967989	340	PACT MCR-V2-4012- 70- 500-5A-1	2277682	215	PLC-BSC-120UC/21HG/SO46	2980432	334
MINI MCR-SL-I-U-4	2813538	71	OPT- 5DC/ 24DC/ 1	2982113	288	PACT MCR-V2-4012- 70- 600-5A-1	2277132	215	PLC-BSC-230UC/ 1/SEN/SO46	2980348	335
MINI MCR-SL-I-U-4-SP	2813567	71	OPT- 5DC/ 48DC/ 100	2982113	288	PACT MCR-V2-4012- 70- 750-5A-1	2277695	215	PLC-BSC-230UC/21-21/SO46	2980429	335
MINI MCR-SL-MUX-V8-FLK 16	2811815	95	OPT- 5DC/ 24DC/ 2	2982168	289	PACT MCR-V2-4012- 70- 800-5A-1	2277145	215	PLC-BSC-230UC/21/SO46	2980335	334
MINI MCR-SL-NAM-2RNO	2864105	86	OPT- 5DC/230AC/ 2	2982168	289	PACT MCR-V2-4012- 70- 1000-5A-1	2277158	215	PLC-BSC-230UC/21HG/SO46	2980445	335
MINI MCR-SL-NAM-2RNO-SP	2810269	86	OPT-24DC/ 24DC/ 2	2966595	280	PACT MCR-V2-5012- 85- 150-5A-1	2276117	216	PLC-BSC-TTL/1	2982689	356
MINI MCR-SL-PT100-LP	2810298	79	OPT-24DC/ 24DC/ 5	2982100	288	PACT MCR-V2-5012- 85- 200-5A-1	2276120	216	PLC-BSP- 24DC/21RW	2961396	360
MINI MCR-SL-PT100-LP-NC	2810308	79	OPT-24DC/ 48DC/100	2982618	340	PACT MCR-V2-5012- 85- 250-5A-1	2276133	216	PLC-BSP- 24UC/ 1/ACT	2982809	329
MINI MCR-SL-PT100-LP-NC-SP	2810395	79	OPT-24DC/230AC/ 1	2967950	281	PACT MCR-V2-5012- 85- 300-5A-1	2276146	216	PLC-BSP-120UC/ 1/SEN/SO46	2980364	335
MINI MCR-SL-PT100-LP-SP	2810382	79	OPT-24DC/230AC/ 2	2982171	289	PACT MCR-V2-5012- 85- 400-5A-1	2277161	216	PLC-BSP-120UC/21/SO46	2980351	334
MINI MCR-SL-PT100-UI	2864435	77	OPT-60DC/ 24DC/ 2	2966605	340	PACT MCR-V2-5012- 85- 500-5A-1	2276159	216	PLC-BSP-230UC/ 1/SEN/SO46	2980380	335
MINI MCR-SL-PT100-UI-200	2864309	78	OPT-60DC/ 24DC/ 5	2982126	288	PACT MCR-V2-5012- 85- 600-5A-1	2276162	216	PLC-BSP-230UC/21/SO46	2980377	334
MINI MCR-SL-PT100-UI-200-NC	2864370	77	OPT-60DC/ 48DC/100	2966621	340	PACT MCR-V2-5012- 85- 600-5A-1	2277174	216	PLC-BSP-TTL/1	2982692	356
MINI MCR-SL-PT100-UI-200-SP	2864192	77	OPT-60DC/230AC/ 1	2967963	341	PACT MCR-V2-5012- 85- 750-5A-1	2276175	216	PLC-ESK GY	2966508	368
MINI MCR-SL-PT100-UI-200-SP-NC	2864202	77	OPT-60DC/230AC/ 2	2982184	289	PACT MCR-V2-5012- 85- 800-5A-1	2277187	216	PLC-OPT- 5DC/ 24DC/100KHZ	2902969	354
MINI MCR-SL-PT100-UI-NC	2864273	78	OV-24DC/ 60DC/4	2982647	559	PACT MCR-V2-5012- 85- 1000-5A-1	2276463	216	PLC-OPT- 5DC/ 24DC/3RW	2900375	327
MINI MCR-SL-PT100-UI-SP	2864736	78	OV-24DC/350DC/1	2982634	558	PACT MCR-V2-5012- 85- 1000-5A-1	2277190	216	PLC-OPT- 5DC/ 5DC/100KHZ-G	2902971	355
MINI MCR-SL-PT100-UI-SP-NC	2864286	78	OV-24DC/480AC/5	2982650	559	PACT MCR-V2-5012- 85-1250-5A-1	2277200	216	PLC-OPT- 5DC/24DC/100KHZ-G	2902973	355
MINI MCR-SL-PTB	2864134	90				PACT MCR-V2-5012- 85-1500-5A-1	2276188	216	PLC-OPT- 5DC/300DC/1	2900381	352
MINI MCR-SL-PTB-FM	2902958	89				PACT MCR-V2-5012- 85- 200-5A-1	2277873	217	PLC-OPT- 12DC/300DC/1	2900382	352
MINI MCR-SL-PTB-FM-SP	2902959	89				PACT MCR-V2-6015- 85- 250-5A-1	2277886	217	PLC-OPT- 24DC/ 24DC/10R	2900398	353
MINI MCR-SL-PTB-SP	2864147	90				PACT MCR-V2-6015- 85- 300-5A-1	2277899	217	PLC-OPT- 24DC/ 24DC/2	2900364	325
MINI MCR-SL-R-UI	2864095	84				PACT MCR-V2-6015- 85- 400-5A-1	2277909	217	PLC-OPT- 24DC/ 24DC/2/ACT	2900376	327
MINI MCR-SL-R-UI-SP	2810256	84				PACT MCR-V2-6015- 85- 500-5A-1	2277912	217	PLC-OPT- 24DC/ 24DC/3RW	2900379	359
MINI MCR-SL-RPS-I	2864422	73	P			PACT MCR-V2-6015- 85- 600-5A-1	2277925	217	PLC-OPT- 24DC/ 48DC/100	2900352	324
MINI MCR-SL-RPS-I-I-SP	2864752	73	PACT MCR-CB-21- 8	2277569	223	PACT MCR-V2-6015- 85- 750-5A-1	2277938	217	PLC-OPT- 24DC/ 48DC/100/SEN	2900358	351
MINI MCR-SL-RPSS-I	2864079	73	PACT MCR-CB-21-12	2277556	223	PACT MCR-V2-6015- 85- 800-5A-1	2277941	217	PLC-OPT- 24DC/ 48DC/500W	2900378	353
MINI MCR-SL-RPSS-I-I-SP	2810230	73	PACT MCR-CB-28-12	2277543	223	PACT MCR-V2-6015- 85- 1000-5A-1	2277954	217	PLC-OPT- 24DC/ 5DC/100KHZ-G	2902972	355
MINI MCR-SL-SHUANT-UI	2810858	68	PACT MCR-CB-42-12	2277530	223	PACT MCR-V2-6015- 85- 1250-5A-1	2277967	217	PLC-OPT- 24DC/110DC/3RW	2900391	359
MINI MCR-SL-SHUANT-UI-NC	2810780	68	PACT MCR-ETC-60	2277572	223	PACT MCR-V2-6015- 85-1500-5A-1	2277970	217	PLC-OPT- 24DC/230AC/1	2900369	325
MINI MCR-SL-SHUANT-UI-SP	2810874	68	PACT MCR-ETC-75	2277585	223	PACT MCR-V2-6015- 85-1600-5A-1	2277983	217	PLC-OPT- 24DC/24DC/100KHZ	2902970	354
MINI MCR-SL-SHUANT-UI-SP-NC	2810793	68	PACT MCR-ICAP	2277608	223	PACT MCR-V2-6040- 96- 600-5A-1	2276191	218	PLC-OPT- 24DC/24DC/100KHZ-G	2902974	355
MINI MCR-SL-TB	2811420	80	PACT MCR-RA	2277598	223	PACT MCR-V2-6040- 96- 750-5A-1	2276201	218	PLC-OPT- 24DC/300DC/1	2900383	352
MINI MCR-SL-TC-UI	2864448	81	PACT MCR-V1-21-44	2277268	213	PACT MCR-V2-6040- 96- 800-5A-1	2276214	218	PLC-OPT- 24DC/TTL	2900363	358
MINI MCR-SL-TC-UI-NC	2864299	81	P								

Type	Order No.	Page	Type	Order No.	Page	Type	Order No.	Page	Type	Order No.	Page
PLC-OPT-110DC/24DC/3RW	2900380	359	PLC-OSP-60DC/230AC/1	2967918	325	PLC-RSC-12DC/21AU	2966919	323	PLC-RSP-110UC/21-21/RW	2987147	363
PLC-OPT-110DC/110DC/3RW	2900396	359	PLC-OSP-60DC/300DC/1	2980843	352	PLC-RSC-12DC/21HC	2967617	333	PLC-RSP-110UC/21-21AU/RW	2987150	363
PLC-OPT-110DC/300DC/1	2900385	352	PLC-OSP-72DC/110DC/3RW	2982540	359	PLC-RSC-24DC/1-1/ACT	2967109	327	PLC-RSP-110UC/21/RW	2987053	362
PLC-OPT-120AC/300DC/1	2900388	352	PLC-OSP-96DC/110DC/3RW	2982553	359	PLC-RSC-24DC/1/ACT	2966210	326	PLC-RSP-110UC/21AU/RW	2987066	362
PLC-OPT-120UC/24DC/2	2900367	325	PLC-OSP-110DC/24DC/3RW	2980526	359	PLC-RSC-24DC/1AU/SEN	2966317	330	PLC-RSP-110UC/21HC/RW	2987095	363
PLC-OPT-120UC/48DC/100	2900355	324	PLC-OSP-110DC/110DC/3RW	2982566	359	PLC-RSC-24DC/1IC/ACT	2967604	332	PLC-RSP-120UC/1AU/SEN	2967390	363
PLC-OPT-120UC/48DC/100/SEN	2900359	331	PLC-OSP-110DC/300DC/1	2980856	352	PLC-RSC-24DC/21	2966171	322	PLC-RSP-120UC/21	2966524	322
PLC-OPT-120UC/230AC/1	2900372	325	PLC-OSP-120AC/300DC/1	2980872	352	PLC-RSC-24DC/21-21	2967060	323	PLC-RSP-120UC/21-21	2912549	323
PLC-OPT-220DC/300DC/1	2900387	352	PLC-OSP-120UC/24DC/2	2967484	325	PLC-RSC-24DC/21-21AU	2967125	323	PLC-RSP-120UC/2121AU	2912617	323
PLC-OPT-230AC/300DC/1	2900389	352	PLC-OSP-120UC/48DC/100	2967552	324	PLC-RSC-24DC/21AU	2966265	323	PLC-RSP-120UC/21AU	2966582	323
PLC-OPT-230UC/24DC/2	2900368	325	PLC-OSP-120UC/48DC/100/SEN	2967581	331	PLC-RSC-24DC/21HC	2967620	333	PLC-RSP-120UC/21HC	2912316	333
PLC-OPT-230UC/48DC/100	2900356	324	PLC-OSP-120UC/230AC/1	2967921	325	PLC-RSC-24UC/1/S/H	2982236	350	PLC-RSP-230UC/1AU/SEN	2967413	330
PLC-OPT-230UC/48DC/100/SEN	2900361	331	PLC-OSP-220DC/300DC/1	2980869	352	PLC-RSC-24UC/1/S/L	2834876	350	PLC-RSP-230UC/21	2966537	322
PLC-OPT-230UC/230AC/1	2900374	325	PLC-OSP-230AC/300DC/1	2980885	352	PLC-RSC-24UC/21	2966184	322	PLC-RSP-230UC/21-21	2912552	323
PLC-OPT-LPE-24DC/48DC/100	2903173	366	PLC-OSP-230UC/24DC/2	2967497	325	PLC-RSC-24UC/21-21	2967073	323	PLC-RSP-230UC/21-21AU	2912620	323
PLC-OSC-5DC/5DC/100KHZ-G	2902965	355	PLC-OSP-230UC/48DC/100	2967565	324	PLC-RSC-24UC/21-21AU	2967112	323	PLC-RSP-230UC/21-21AU/RWF	2968001	361
PLC-OSC-5DC/24DC/2/ACT	2980144	327	PLC-OSP-230UC/48DC/100/SEN	2967594	331	PLC-RSC-24UC/21AU	2966278	323	PLC-RSP-230UC/21AU	2966647	323
PLC-OSC-5DC/24DC/100KHZ-G	2902967	355	PLC-OSP-230UC/230AC/1	2980833	325	PLC-RSC-24UC/21HC	2967633	333	PLC-RSP-230UC/21HC	2912329	333
PLC-OSC-5DC/24DC/100KHZ	2902963	354	PLC-PT-EIK 1-SVN 24P/P	2900397	364	PLC-RSC-48DC/21	2966113	322	PLC-SC-EIK 1-SVN 24P/P	2982663	364
PLC-OSC-5DC/300DC/1	2980652	352	PLC-RPT-12DC/21	2900316	322	PLC-RSC-48DC/21-21	2967248	323	PLC-SC-ELR W1/2-24DC	2980539	365
PLC-OSC-12DC/300DC/1	2980665	352	PLC-RPT-12DC/21-21	2900329	323	PLC-RSC-48DC/21-21AU	2967280	323	PLC-SC-S/H	2980733	351
PLC-OSC-24DC/5DC/100KHZ-G	2902967	355	PLC-RPT-12DC/21-21AU	2900337	323	PLC-RSC-48DC/21AU	2966126	323	PLC-SC-S/L	2980775	351
PLC-OSC-24DC/24DC/2	2966634	325	PLC-RPT-12DC/21AU	2900317	323	PLC-RSC-48DC/21HC	2967646	333	PLC-SP-EIK 1-SVN 24P/P	2982676	364
PLC-OSC-24DC/24DC/2/ACT	2966676	327	PLC-RPT-12DC/21HC	2900290	333	PLC-RSC-60DC/21	2966139	322	PLC-SP-ELR W1/2-24DC	2980555	365
PLC-OSC-24DC/24DC/5/ACT	2982786	328	PLC-RPT-24DC/1/ACT	2900312	326	PLC-RSC-60DC/21-21	2967293	323	PLC-SP-S/H	2980746	351
PLC-OSC-24DC/24DC/10/R	2982702	353	PLC-RPT-24DC/1AU/SEN	2900313	330	PLC-RSC-60DC/21-21AU	2967303	323	PLC-SP-S/L	2980788	351
PLC-OSC-24DC/24DC/100KHZ-G	2902968	355	PLC-RPT-24DC/1IC/ACT	2900298	332	PLC-RSC-60DC/21AU	2966142	323	PLC-V8/D15B/IN	2296087	369
PLC-OSC-24DC/48DC/100	2966728	324	PLC-RPT-24DC/21	2900299	332	PLC-RSC-60DC/21HC	2967659	333	PLC-V8/D15B/OUT	2296061	369
PLC-OSC-24DC/48DC/100/SEN	2966773	331	PLC-RPT-24DC/21-21	2900330	323	PLC-RSC-120UC/1AU/SEN	2966320	330	PLC-V8/D15S/IN	2296074	369
PLC-OSC-24DC/48DC/500/W	2980636	353	PLC-RPT-24DC/21-21AU	2900338	323	PLC-RSC-120UC/21	2966197	322	PLC-V8/D15S/OUT	2296058	369
PLC-OSC-24DC/230AC/1	2967840	325	PLC-RPT-24DC/21AU	2900306	323	PLC-RSC-120UC/21-21	2967086	323	PLC-V8/FLK14/IN	2296553	369
PLC-OSC-24DC/230AC/1/ACT	2967947	327	PLC-RPT-24DC/21HC	2900291	333	PLC-RSC-120UC/21-21AU	2967138	323	PLC-V8/FLK14/IN/M	2304115	369
PLC-OSC-24DC/230AC/2/ACT	2982760	328	PLC-RPT-24UC/1/S/H	2900328	350	PLC-RSC-120UC/21AU	2966281	323	PLC-V8/FLK14/OUT	2295554	369
PLC-OSC-24DC/24DC/100KHZ	2902964	354	PLC-RPT-24UC/1/S/L	2900327	350	PLC-RSC-120UC/21HC	2967662	333	PLC-V8/FLK14/OUT/M	2304102	369
PLC-OSC-24DC/300DC/1	2980678	352	PLC-RPT-24UC/21	2900300	322	PLC-RSC-230UC/1AU/SEN	2966333	330	PLC-V8/FLK14/OUT	2299660	369
PLC-OSC-24DC/TTL	2982728	358	PLC-RPT-24UC/21-21	2900332	323	PLC-RSC-230UC/21	2966207	332	PLC-V8/FLK14/OUT/M	2304306	369
PLC-OSC-48DC/24DC/2	2967002	325	PLC-RPT-24UC/21-21/RW	2900346	363	PLC-RSC-230UC/21-21	2967099	323	PLC-VT	2296870	486
PLC-OSC-48DC/48DC/100	2966993	324	PLC-RPT-24UC/21-21AU	2900339	323	PLC-RSC-230UC/21-21AU	2967141	323	PLC-VT/ACT	2295567	487
PLC-OSC-48DC/230AC/1	2967853	325	PLC-RPT-24UC/21-21AU/RW	2900349	363	PLC-RSC-230UC/21AU	2966294	323	PLC-VT/ACT/LA	2296867	487
PLC-OSC-60DC/24DC/2	2967468	325	PLC-RPT-24UC/21/RW	2900318	362	PLC-RSC-230UC/21HC	2967675	333	PLC-VTLA	2296854	486
PLC-OSC-60DC/48DC/100	2967455	324	PLC-RPT-24UC/21AU	2900307	323	PLC-RSP-12DC/21	2967439	322	PR1-BSC2/2X21	2833518	372
PLC-OSC-60DC/230AC/1	2967866	325	PLC-RPT-24UC/21AU/RW	2900321	362	PLC-RSP-12DC/21-21	2912497	323	PR1-BSC3/2X21	2833521	373
PLC-OSC-60DC/300DC/1	2980681	352	PLC-RPT-24UC/21HC	2900293	333	PLC-RSP-12DC/21-21AU	2912565	323	PR1-BSP3/2X21	2833534	373
PLC-OSC-110DC/300DC/1	2980694	352	PLC-RPT-24UC/21HC/RW	2900324	363	PLC-RSP-12DC/21AU	2967442	323	PR1-RSC3-LDP-24DC/21	2834326	390
PLC-OSC-120AC/300DC/1	2980717	352	PLC-RPT-48DC/21	2900301	322	PLC-RSP-12DC/21HC	2912264	333	PR1-RSC3-LDP-24DC/21AU	2834368	390
PLC-OSC-120UC/24DC/2	2966650	325	PLC-RPT-48DC/21-21	2900333	323	PLC-RSP-24DC/1/ACT	2967345	326	PR1-RSC3-LDP-24DC/2X21	2834481	391
PLC-OSC-120UC/48DC/100	2966744	324	PLC-RPT-48DC/21-21AU	2900340	323	PLC-RSP-24DC/1AU/SEN	2967374	330	PR1-RSC3-LDP-24DC/2X21AU	2834520	391
PLC-OSC-120UC/48DC/100/SEN	2966799	331	PLC-RPT-48DC/21AU	2900308	323	PLC-RSP-24DC/1IC/ACT	2912413	332	PR1-RSC3-LV-24AC/21	2834339	390
PLC-OSC-120UC/230AC/1	2967879	325	PLC-RPT-48DC/21HC	2900294	333	PLC-RSP-24DC/21	2966472	322	PR1-RSC3-LV-24AC/21AU	2834371	390
PLC-OSC-125DC/24DC/2	2980050	325	PLC-RPT-60DC/21	2900303	322	PLC-RSP-24DC/21-21	2912507	323	PR1-RSC3-LV-24AC/2X21	2834494	391
PLC-OSC-125DC/48DC/100	2980047	324	PLC-RPT-60DC/21-21	2900334	323	PLC-RSP-24DC/21-21AU	2912578	323	PR1-RSC3-LV-24AC/2X21AU	2834533	391
PLC-OSC-125DC/230AC/1	2980063	325	PLC-RPT-60DC/21-21AU	2900341	323	PLC-RSP-24DC/21AU	2966540	323	PR1-RSC3-LV-120AC/21	2834342	390
PLC-OSC-220DC/300DC/1	2980704	352	PLC-RPT-60DC/21AU	2900309	323	PLC-RSP-24DC/21HC	2912277	333	PR1-RSC3-LV-120AC/21AU	2834384	390
PLC-OSC-230AC/300DC/1	2980720	352	PLC-RPT-60DC/21HC	2900295	333	PLC-RSP-24UC/1/S/H	2982249	350	PR1-RSC3-LV-120AC/2X21	2834504	391
PLC-OSC-230UC/24DC/2	2966663	325	PLC-RPT-72UC/21-21/RW	2900347	363	PLC-RSP-24UC/1/S/L	2834889	350	PR1-RSC3-LV-120AC/2X21AU	2834546	391
PLC-OSC-230UC/48DC/100	2966757	324	PLC-RPT-72UC/21-21AU/RW	2900350	363	PLC-RSP-24UC/21	2966485	322	PR1-RSC3-LV-230AC/21	2834355	390
PLC-OSC-230UC/48DC/100/SEN	2966809	331	PLC-RPT-72UC/21/RW	2900319	362	PLC-RSP-24UC/21-21	2912510	323	PR1-RSC3-LV-230AC/21AU	2834397	390
PLC-OSC-230UC/230AC/1	2967882	325	PLC-RPT-72UC/21AU/RW	2900322	362	PLC-RSP-24UC/21-21/RW	2987105	363	PR1-RSC3-LV-230AC/2X21	2834517	391
PLC-OSC-LPE-24DC/48DC/100	2903171	366	PLC-RPT-72UC/21HC/RW	2900325	363	PLC-RSP-24UC/21-21AU	2912581	323	PR1-RSC3-LV-230AC/2X21AU	2834559	391
PLC-OSP-5DC/24DC/2/ACT	2980157	327	PLC-RPT-110UC/21-21/RW	2900348	363	PLC-RSP-24UC/21-21AU/RW	2987118	363	PR1-RSP3-LDP-24DC/21	2834407	392
PLC-OSP-5DC/300DC/1	2980814	352	PLC-RPT-110UC/21-21AU/RW	2900351	363	PLC-RSP-24UC/21/RW	2987011	362	PR1-RSP3-LDP-24DC/21AU	2834449	392
PLC-OSP-12DC/300DC/1	2980827	352	PLC-RPT-110UC/21/RW	2900320	362	PLC-RSP-24UC/21AU	2966553	323	PR1-RSP3-LDP-24DC/2X21	2834562	393
PLC-OSP-24DC/24DC/2	2967471	325	PLC-RPT-110UC/21AU/RW	2900323	362	PLC-RSP-24UC/21AU/RW	2987024	362	PR1-RSP3-LDP-24DC/2X21AU	2834601	393
PLC-OSP-24DC/24DC/2/ACT	2967507	327	PLC-RPT-110UC/21HC/RW	2900326	363	PLC-RSP-24UC/21HC	2912280	333	PR1-RSP3-LV-24AC/21	2834410	392
PLC-OSP-24DC/24DC/3RW	2980513	359	PLC-RPT-120UC/1AU/SEN	2900314	330	PLC-RSP-24UC/21HC/RW	2987079	363	PR1-RSP3-LV-24AC/21AU	2834452	392
PLC-OSP-24DC/110DC/3RW	2982524	358	PLC-RPT-120UC/21	2900304	322	PLC-RSP-48DC/21	2966498	322	PR1-RSP3-LV-120AC/2X21	2834575	393
PLC-OSP-24DC/48DC/100	2967549	324	PLC-RPT-120UC/21-21	2900335	323	PLC-RSP-48DC/21-21	2912523	323	PR1-RSP3-LV-24AC/2X21AU	2834614	393
PLC-OSP-24DC/48DC/100/SEN	2967578	331	PLC-RPT-120UC/21-21AU	2900342	323	PLC-RSP-48DC/21-21AU	2912594	323	PR1-RSP3-LV-120AC/21	2834423	392
PLC-OSP-24DC/110DC/500/W	2980649	353	PLC-RPT-120UC/21AU	2900310	323	PLC-RSP-48DC/21AU	2966566	323	PR1-RSP3-LV-120AC/21AU	2834465	392
PLC-OSP-24DC/110DC/3RW	2982511	359									

Index

Alphabetical

Type	Order No.	Page	Type	Order No.	Page	Type	Order No.	Page	Type	Order No.	Page
PR2-RSC3-LV-24AC/2X21	2834656	394	REL-IR2/LDP-60DC/2X21	2903662	292	REL-OR/L-24AC/1	2901911	386	RIF-4-RPT-LV-120AC/2X21	2903280	314
PR2-RSC3-LV-24AC/4X21AU	2834737	394	REL-IR2/LDP-110DC/2X21	2903663	292	REL-OR/L-24AC/1/MB	2901905	386	RIF-4-RPT-LV-120AC/3X1	2903274	316
PR2-RSC3-LV-120AC/2X21	2834669	394	REL-IR4/L-24AC/4X21	2903686	292	REL-OR/L-120AC/1	2901912	386	RIF-4-RPT-LV-120AC/3X21	2903277	315
PR2-RSC3-LV-120AC/4X21AU	2834740	394	REL-IR4/L-24AC/4X21AU	2903683	292	REL-OR/L-120AC/1/MB	2901906	386	RIF-4-RPT-LV-230AC/2X21	2903279	314
PR2-RSC3-LV-230AC/2X21	2834672	394	REL-IR4/L-120AC/4X21	2903687	292	REL-OR/L-230AC/1	2901913	386	RIF-4-RPT-LV-230AC/3X1	2903273	316
PR2-RSC3-LV-230AC/4X21AU	2834753	394	REL-IR4/L-120AC/4X21AU	2903684	292	REL-OR/L-230AC/1/MB	2901907	386	RIF-4-RPT-LV-230AC/3X21	2903276	315
PR2-RSP3-LDP-24DC/2X21	2834685	395	REL-IR4/L-230AC/4X21	2903688	292	REL-OR/LDP-24DC/1	2901908	386	RIF-LDP-110 DC	2900941	304
PR2-RSP3-LDP-24DC/4X21AU	2834766	395	REL-IR4/L-230AC/4X21AU	2903685	292	REL-OR/LDP-24DC/1/MB	2901901	386	RIF-LDP-12-24 DC	2900939	304
PR2-RSP3-LV-24AC/2X21	2834698	395	REL-IR4/LDP-12DC/4X21	2903676	292	REL-OR/LDP-110DC/1	2901909	386	RIF-LDP-48-60 DC	2900940	304
PR2-RSP3-LV-24AC/4X21AU	2834779	395	REL-IR4/LDP-12DC/4X21AU	2903669	292	REL-OR/LDP-110DC/1/MB	2901902	386	RIF-LV-12-24 UC	2900942	304
PR2-RSP3-LV-120AC/2X21	2834708	395	REL-IR4/LDP-24DC/4X21	2903677	292	REL-OR/LDP-220DC/1	2901910	386	RIF-LV-120-230 AC/110 DC	2900944	304
PR2-RSP3-LV-120AC/4X21AU	2834782	395	REL-IR4/LDP-24DC/4X21AU	2903670	292	REL-OR/LDP-220DC/1/MB	2901904	386	RIF-LV-48-60 UC	2900943	304
PR2-RSP3-LV-230AC/2X21	2834711	395	REL-IR4/LDP-48DC/4X21	2903678	292	REL-OR2/L-24AC/2X21	2903690	296	RIF-RC-12-24 UC	2900949	304
PR2-RSP3-LV-230AC/4X21AU	2834795	395	REL-IR4/LDP-48DC/4X21AU	2903671	292	REL-OR2/L-120AC/2X21	2903691	296	RIF-RC-120-230 UC	2900951	304
PR3-BSC1/2X21	2833602	382	REL-IR4/LDP-60DC/4X21	2903679	292	REL-OR2/L-230AC/2X21	2903692	296	RIF-RC-48-60 UC	2900950	304
PR3-BSC1/3X21	2833615	383	REL-IR4/LDP-60DC/4X21AU	2903672	292	REL-OR2/LDP-24DC/2X21	2903689	296	RIF-RH-1	2900953	283
PSK AFS2000IOL	2700709	209	REL-IR4/LDP-110DC/4X21	2903680	292	REL-OR3/L-24AC/3X21	2903694	296	RIF-RH-2	2900954	291
PSK AFS5000IOL	2700725	209	REL-IR4/LDP-110DC/4X21AU	2903673	292	REL-OR3/L-120AC/3X21	2903695	296	RIF-RH-3	2900955	295
PSK AFS6000IOL	2700707	208	REL-MR 4_5DC/21AU	2961370	338	REL-OR3/L-230AC/3X21	2903696	296	RIF-RH-4	2900956	299
PSK AFS6050IOL	2700704	208	REL-MR- 4_5DC/21	2961367	338	REL-OR3/LDP-24DC/3X21	2903693	296	RIF-T3-24UC	2902647	305
PSK AFS8000IOL	2700708	209	REL-MR- 12DC/21	2961150	278	REL-PR2-24AC/2X21	2903699	300	RIF-V-12-24 UC	2900945	304
PSK DL BASIC	2700726	206	REL-MR- 12DC/21-21	2961257	284	REL-PR2-24DC/2X21	2903698	300	RIF-V-120-230 UC	2900948	304
PSK DL FLEX	2700727	207	REL-MR- 12DC/21-21AU	2961299	284	REL-PR2-120AC/2X21	2903700	300	RIF-V-48-60 UC	2900947	304
PSM-KAD 9 SUB 25/BS	2761295	149	REL-MR- 12DC/21AU	2961163	278	REL-PR2-230AC/2X21	2903701	300			
PSM-ME-RS232/RS485-P	2744416	186	REL-MR- 12DC/21HC	2961309	284	REL-PR3-24AC/3X1	2903707	302			
PSM-ME-RS485/RS485-P	2744429	186	REL-MR- 12DC/21HC AU	2961532	284	REL-PR3-24AC/3X21	2903703	300			
			REL-MR- 18DC/21	2961383	338	REL-PR3-24DC/3X1	2903706	302			
			REL-MR- 18DC/21AU	2961493	338	REL-PR3-24DC/3X21	2903702	300			
			REL-MR- 24AC/21-21	2961435	284	REL-PR3-120AC/3X1	2903708	302	SCK-C-MODBUS	2901674	240
			REL-MR- 24AC/21-21/MS	2987956	286	REL-PR3-120AC/3X21	2903704	300	SCK-M-I-4S-20A	2903242	241
			REL-MR- 24AC/21-21AU	2961464	284	REL-PR3-230AC/3X1	2903709	302	SCK-M-I-8S-20A	2903241	241
			REL-MR- 24AC/21HC	2961406	284	REL-PR3-230AC/3X21	2903705	300	SCK-M-U-1500V	2903591	241
									SIM-AMS 1	2271015	560
									SIM-AMS 1-R	2271031	561
									SIM-AMS 2	2271028	560
									SIM-AMS 2-R	2271044	561
RC- 12- 24UC	2833741	388	REL-MR- 24AC/21HC AU	2961503	284	RIF-0-BPT/1	2901873	277	SIM-AMS C1	2271390	561
RC- 48- 60UC	2833754	388	REL-MR- 24AC/21HC/MS	2987891	286	RIF-0-BPT/21	2900958	276	SIM-EI- 5DC/48DC/100	2271057	557
RC-120-230UC	2833767	388	REL-MR- 24DC/11C	2961341	339	RIF-0-RPT-12DC/ 1	2903362	307	SIM-EI- 5DC/TTL/100	2271138	556
RC3- 12- 24UC	2833893	388	REL-MR- 24DC/21	2961105	278	RIF-0-RPT-12DC/ 1AU	2903360	307	SIM-EI- 12DC/48DC/100	2271060	556
RC3- 48- 60UC	2833903	388	REL-MR- 24DC/21-21	2961192	284	RIF-0-RPT-12DC/21	2903371	306	SIM-EI- 24DC/48DC/100	2271141	557
RC3-120-230UC	2833916	388	REL-MR- 24DC/21-21/MS	2987943	286	RIF-0-RPT-12DC/21AU	2903369	306	SIM-EI- 24DC/TTL/100	2271073	556
RCM-A-SCT- 20	2806045	245	REL-MR- 24DC/21-21AU	2961215	284	RIF-0-RPT-24DC/ 1	2903361	307	SIM-EI- 60DC/48DC/100	2271138	557
RCM-A-SCT- 30	2806058	245	REL-MR- 24DC/21-21AU/MS	2987985	286	RIF-0-RPT-24DC/ 1AU	2903359	307	SIM-EI- 60DC/48DC/100	2271086	556
RCM-A-SCT- 35	2806061	245	REL-MR- 24DC/21AU	2961121	278	RIF-0-RPT-24DC/21	2903370	306	SIM-EI- 60DC/TTL/100	2271167	557
RCM-A-SCT- 70	2806074	245	REL-MR- 24DC/21HC	2961312	284	RIF-0-RPT-24DC/21AU	2903368	306	SIM-EI- 110DC/48DC/100	2271099	556
RCM-A-SCT-105	2806087	245	REL-MR- 24DC/21HC AU	2961545	284	RIF-1-BPT/2X21	2900931	282	SIM-EI- 110DC/TTL/100	2271154	557
RCM-A-SCT-140	2806090	245	REL-MR- 24DC/21HC AU/MS	2987927	286	RIF-1-RPT-LDP-24DC/1X21	2903342	308	SIM-EI- 120AC/48DC/100	2271112	556
RCM-A-SCT-210	2806100	245	REL-MR- 24DC/21HC/MS	2987888	286	RIF-1-RPT-LDP-24DC/1X21AU	2903338	308	SIM-EI- 120AC/48DC/100/RC	2271439	557
RCM-A/50/85-26V	2806016	245	REL-MR- 48DC/21-21	2834834	284	RIF-1-RPT-LDP-24DC/2X21	2903334	309	SIM-EI- 120AC/TTL/100	2271196	557
RCM-B-SCT- 35	2806223	244	REL-MR- 48DC/21-21AU	2834847	284	RIF-1-RPT-LDP-24DC/2X21AU	2903330	309	SIM-EI- 120DC/48DC/100	2271196	557
RCM-B-SCT- 70	2806236	244	REL-MR- 48DC/21HC	2834821	284	RIF-1-RPT-LV-120AC/1X21	2903340	308	SIM-EI- 200DC/48DC/100	2271183	557
RCM-B-SCT-105	2806249	244	REL-MR- 60DC/21	2961118	338	RIF-1-RPT-LV-120AC/1X21AU	2903336	308	SIM-EI- 230AC/48DC/100	2271125	556
RCM-B/50/85-26V	2806210	244	REL-MR- 60DC/21-21	2961273	284	RIF-1-RPT-LV-120AC/2X21	2903332	309	SIM-EI- 230AC/48DC/100/RC	2271426	557
REL-IR/L- 24AC/2X21	2834054	380	REL-MR- 60DC/21-21AU	2961286	284	RIF-1-RPT-LV-120AC/2X21AU	2903328	309	SIM-EI- 230AC/TTL/100	2271206	557
REL-IR/L- 24AC/4X21AU	2834122	380	REL-MR- 60DC/21AU	2961134	338	RIF-1-RPT-LV-230AC/1X21	2903339	308	SIM-EI- 24DC/ 24DC/3	2300096	557
REL-IR/L-120AC/2X21	2834067	380	REL-MR- 60DC/21HC	2961325	284	RIF-1-RPT-LV-230AC/1X21AU	2903335	308	SIM-ERSN	2271484	556
REL-IR/L-120AC/4X21AU	2834135	380	REL-MR-110DC/21-21	2961202	284	RIF-1-RPT-LV-230AC/2X21	2903331	309	SIM-ERSN-HB-KSR	2271468	556
REL-IR/L-230AC/2X21	2834070	380	REL-MR-110DC/21-21AU	2961228	284	RIF-1-RPT-LV-230AC/2X21AU	2903327	309	SIM-ERSN-HB-KSR/MET	2271497	556
REL-IR/L-230AC/4X21AU	2834148	380	REL-MR-110DC/21HC	2961338	284	RIF-1-RPT-LV-24AC/1X21	2903341	308	SIM-ERSN-HB-MR	2271471	556
REL-IR/LDM- 12DC/2X21	2834151	380	REL-MR-110DC/21HC AU	2961561	284	RIF-1-RPT-LV-24AC/1X21AU	2903337	308	SIM-ERSN-HB-MR/MET	2271510	556
REL-IR/LDM- 12DC/4X21AU	2834193	380	REL-MR-120AC/21-21	2961448	284	RIF-1-RPT-LV-24AC/2X21	2903333	309	SSA 3-6	2839295	191
REL-IR/LDM- 24DC/2X21	2834164	380	REL-MR-120AC/21-21/MS	2987969	286	RIF-1-RPT-LV-24AC/2X21AU	2903329	309	SSA 5-10	2839512	191
REL-IR/LDM- 24DC/4X21AU	2834203	380	REL-MR-120AC/21-21AU	2961477	284	RIF-2-BPT/4X21	2900934	290	ST-OV3- 24DC/400AC/3	2905417	408
REL-IR/LDM- 48DC/2X21	2834177	380	REL-MR-120AC/21HC	2961419	284	RIF-2-RPT-LDP-24DC/2X21	2903315	310	ST-OV4- 24DC/ 24DC/1-PRO	2905572	409
REL-IR/LDM- 48DC/4X21AU	2834216	380	REL-MR-120AC/21HC AU	2961516	284	RIF-2-RPT-LDP-24DC/4X21	2903308	311	ST-OV4- 24DC/ 24DC/4-PRO	2905585	409
REL-IR/LDM-110DC/2X21	2834180	380	REL-MR-120AC/21HC/MS	2987901	286	RIF-2-RPT-LV-120AC/2X21	2903311	310	ST-REL3-KG 24/ 1/SO38	2829564	406
REL-IR/LDM-110DC/4X21AU	2834229	380	REL-MR-230AC/21-21	2961451	284	RIF-2-RPT-LV-120AC/4X21	2903305	311	ST-REL3-KG 24/21/AU/SO46	2826981	404
REL-IR/LDP- 12DC/2X21	2834012	380	REL-MR-230AC/21-21/MS	2987972	286	RIF-2-RPT-LV-230AC/2X21	2903310	310	ST-REL3-KG 24/21/SO46	2826091	404
REL-IR/LDP- 12DC/4X21AU	2834083	380	REL-MR-230AC/21-21AU	2961480	284	RIF-2-RPT-LV-230AC/4X21	2903304	311	ST-REL3-KG 120/21/AU/SO46	2829797	404
REL-IR/LDP- 24DC/2X21	2834025	380	REL-MR-230AC/21-21AU/MS	2987998	286	RIF-2-RPT-LV-24AC/2X21	2903313	310	ST-REL3-KG 120/21/SO46	2833026	404
REL-IR/LDP- 24DC/4X21AU	2834096	380	REL-MR-230AC/21HC	2961422	284	RIF-2-RPT-LV-24AC/4X21	2903306	311	ST-REL3-KG 230/21/AU/SO46	2826266	404
REL-IR/LDP-110DC/2X21	2834041	380	REL-MR-230AC/21HC AU	2961529	284	RIF-3-BPT/2X21	2900937	294	ST-REL3-KG 240/21/AU/SO46	2829797	404
REL-IR/LDP-110DC/4X21AU	2834119	380	REL-MR-230AC/21HC AU/MS	2987930	286	RIF-3-BPT/3X21	2900938	295	ST-REL3-KG 240/21/AU/SO46	2833026	4

Type	Order No.	Page	Type	Order No.	Page	Type	Order No.	Page	Type	Order No.	Page
SWD4-CRP-2 PXC	2903114	34	UMK- 8 RM/KSR-G 24/21/PLC	2979485	494	VIP-2/PT/FLK14/LED/PLC	2904279	470	VIP-3/PT/HD26SUB/M	2904269	539
SWD4-RC8-10 PXC	2903106	34	UMK- 8 RM/MR-G24/1/PLC	2979469	492	VIP-2/PT/FLK14/PLC	2903801	470	VIP-3/PT/HD44SUB/F	2904274	539
SZF 1-0,6X3,5	1204517	368	UMK- 8 RM110DC/MKDS	2972945	551	VIP-2/PT/FLK16	2903789	526	VIP-3/PT/HD44SUB/M	2904270	539
			UMK- 8 RM230AC/MKDS	2972961	551	VIP-2/PT/FLK16/LED	2904250	527	VIP-3/PT/HD62SUB/F	2904275	539
T											
			UMK- 8 RM24DC/MKDS	2972916	551	VIP-2/PT/FLK20	2903790	526	VIP-3/PT/HD62SUB/M	2904271	539
			UMK- D32M-VS	2970060	541	VIP-2/PT/FLK20/LED	2904251	527	VIP-3/PT/PDM-2/16	2903797	549
			UMK- EC38/38-XOL	2976284	542	VIP-2/PT/FLK50 (1-40) /S7	2903804	472	VIP-3/PT/PDM-2/24	2903798	549
			UMK- EC38/38-XOR	2976297	542	VIP-2/PT/FLK50/16/SLC500	2904287	429	VIP-3/PT/PDM-2/32	2903799	549
TC-D37SUB-ADIO16-EX-P-UNI	2924854	129	UMK- EC56/25/EX -FRONT 2.5V/L	2900115	545	VIP-2/PT/FLK50/AB-1756	2904286	473	VIP-3/PT/PDM-2/48	2903800	549
TC-D37SUB-ADIO16-M-P-UNI	2902933	97	UMK- EC56/25/EX -FRONT 2.5V/R	2900114	545	VIP-2/PT/FLK50/LED/PLC	2904280	471	VIP-3/PT/RJ45	2904290	546
TC-D37SUB-AIO16-EX-PS-UNI	2902932	129	UMK- EC56/25/EX -L	2900113	545	VIP-2/PT/FLK50/MODI-TSX/Q	2904285	473	VIP-3/SC/D25SUB/F	2315188	533
TC-D37SUB-AIO16-M-PS-UNI	2902934	97	UMK- EC56/25/EX -R	2900112	545	VIP-2/PT/FLK50/PLC	2903803	471	VIP-3/SC/D25SUB/F/LED	2322210	533
THERMAL FUSE TF104	2900796	38	UMK- EC56/32-XOL	2975764	543	VIP-2/PT/FLK50/S7/A-S400	2904289	472	VIP-3/SC/D25SUB/M	2315133	533
			UMK- EC56/32-XOR	2975858	543	VIP-2/PT/HD15SUB/F	2904272	539	VIP-3/SC/D25SUB/M/LED	2322168	533
			UMK- EC56/32-XUL	2975780	543	VIP-2/PT/HD15SUB/M	2904268	539	VIP-3/SC/D37SUB/F	2315191	533
			UMK- EC56/32-XUR	2975777	543	VIP-2/SC/2FLK14 (1-20) /S7	2315230	474	VIP-3/SC/D37SUB/F/LED	2322223	533
			UMK- EC56/56-XOL	2975890	543	VIP-2/SC/2FLK14/AB-1756	2322333	475	VIP-3/SC/D37SUB/M	2315146	533
U			UMK- EC56/56-XOR	2975900	543	VIP-2/SC/D 9SUB/F	2315162	532	VIP-3/SC/D37SUB/M/HW/C300	2900675	439
			UMK- EC56/Front 2.5V/L	2976158	543	VIP-2/SC/D 9SUB/F/LED	2322197	533	VIP-3/SC/D37SUB/M/LED	2322171	533
			UMK- EC56/Front 2.5V/R	2976161	543	VIP-2/SC/D 9SUB/M	2315117	532	VIP-3/SC/D50SUB/F	2315201	533
UC-EMLP (11X9)	0819291	127	UMK- EC90/32/EX-XOL	2900110	544	VIP-2/SC/D 9SUB/M/LED	2322142	533	VIP-3/SC/D50SUB/F/LED	2322236	533
UC-EMLP (11X9) CUS	0824547	127	UMK- EC90/32/EX-XOR	2900109	544	VIP-2/SC/D15SUB/F	2315175	532	VIP-3/SC/D37SUB/M	2315159	533
UDK-RELG 4	2777056	409	UMK- EC90/32/EX-XUL	2969071	544	VIP-2/SC/D15SUB/F/LED	2322207	533	VIP-3/SC/D50SUB/M/LED	2322184	533
UKK 5-2R/NAMUR	2941662	183	UMK- EC90/32/EX-XUR	2969068	544	VIP-2/SC/D15SUB/M	2315120	532	VIP-3/SC/FLK14/8IM/LED/PLC	2322265	479
UM 25-10 MSTB/Front/Q	2959803	547	UMK- PVB	2971302	549	VIP-2/SC/D15SUB/M/LED	2322155	533	VIP-3/SC/FLK14/8IM/PLC	2322278	479
UM 25-18 MSTB/Front/Q	2959502	547	UMK- PVB 6	2972136	549	VIP-2/SC/D37SUB/M	2900676	439	VIP-3/SC/FLK26	2315052	525
UM 25-D 9SUB/B/Front/Q	2959560	536	UMK-16 OM-R/MF/MKDS	2972770	553	VIP-2/SC/D37SUB/M/SO	2900786	439	VIP-3/SC/FLK26/LED	2322087	525
UM 25-D50SUB/B/Front/Q	2959573	536	UMK-16 OM-R/MF/MKDS/P	2972796	553	VIP-2/SC/FLK10	2315010	524	VIP-3/SC/FLK34	2315065	525
UM 25-D15SUB/B/Front/Q	2959586	536	UMK-16 OM/MF/MKDS	2972754	553	VIP-2/SC/FLK10/LED	2322045	525	VIP-3/SC/FLK34/LED	2322090	525
UM 25-D15SUB/S/Front/Q	2959599	536	UMK-16 RELS/KSR-G24/21/E/PLC	2974891	495	VIP-2/SC/FLK14	2315023	524	VIP-3/SC/FLK40	2315078	525
UM 25-D25SUB/B/Front/Q	2959609	536	UMK-16 RELS/KSR-G24/21/PLC	2974901	495	VIP-2/SC/FLK14/8M/PLC	2322281	476	VIP-3/SC/FLK40/LED	2322100	525
UM 25-D25SUB/S/Front/Q	2959612	536	UMK-16 RM 5DC/MKDS	2972974	551	VIP-2/SC/FLK14/8P/PLC	2322294	476	VIP-3/SC/FLK50	2315081	525
UM 25-FLK20/Front/Q	2959515	528	UMK-16 RM 12DC/MKDS	2972987	551	VIP-2/SC/FLK14/LED	2322058	525	VIP-3/SC/FLK50/LED	2322113	525
UM 45-8RM/MR-G24/1/PLC	2962900	490	UMK-16 RM 24DC/MKDS	2972990	551	VIP-2/SC/FLK14/LED/PLC	2322249	470	VIP-3/SC/FLK60	2315094	525
UM 45-16RM/MR-G24/1/E/PLC	2962926	491	UMK-16 RM 60DC/MKDS	2973038	551	VIP-2/SC/FLK14/PLC	2315214	470	VIP-3/SC/FLK60/LED	2322126	525
UM 45-16RM/MR-G24/1/PLC	2962913	491	UMK-16 RM/KSR-G 24/21/E/PLC	2979508	495	VIP-2/SC/FLK16	2315036	524	VIP-3/SC/FLK64	2315104	525
UM 45-D37SUB/B/Front/Q	2959625	536	UMK-16 RM/KSR-G 24/21/PLC	2979498	495	VIP-2/SC/FLK16/LED	2322061	525	VIP-3/SC/FLK64/LED	2322139	525
UM 45-D37SUB/S/Front/Q	2959638	536	UMK-16 RM110DC/MKDS	2973041	551	VIP-2/SC/FLK20	2315049	524	VIP-3/SC/HD26SUB/F	2322414	539
UM 45-D50SUB/B/Front/Q	2959641	536	UMK-16 RM230AC/MKDS	2973067	551	VIP-2/SC/FLK20/LED	2322074	525	VIP-3/SC/HD26SUB/M	2322375	539
UM 45-D50SUB/S/Front/Q	2959654	536	UMK-32 MDSTB/MKKDS3/R	2970196	547	VIP-2/SC/FLK50 (1-40) /S7	2315243	472	VIP-3/SC/HD44SUB/F	2322427	539
UM 45-DI/DO/S/LA/SIM8	2968205	483	UMK-32 RM/MR-G24/1/PLC	2979472	492	VIP-2/SC/FLK50/16/SLC500	2322320	429	VIP-3/SC/HD44SUB/M	2322388	539
UM 45-DO/LA/SIM8	2968195	483	UMKS- C64M-VS	2970565	540	VIP-2/SC/FLK50/AB-1756	2322317	473	VIP-3/SC/HD62SUB/F	2322430	539
UM 45-FLK14/ 8IM/SFKDS/PLC	2965211	481	UMKS- E48M-VS	2970154	541	VIP-2/SC/FLK50/LED/PLC	2322252	471	VIP-3/SC/HD62SUB/M	2322391	539
UM 45-FLK34/Front/Q	2959531	528	UMKS- F48M-VR	2970167	541	VIP-2/SC/FLK50/MODI-TSX/Q	2322304	473	VIP-3/SC/RJ45	2900701	546
UM 45-FLK40/Front/Q	2959544	528	UMKS- F48M-VS	2970714	541	VIP-2/SC/FLK50/PLC	2315227	471	VIP-CAB-FLK10-0,14/...	2318376	500
UM 45-FLK50/32M/ZFKDS/PLC	2965224	481	URELG 3	2820136	404	VIP-2/SC/FLK50/S7/A-S400	2322359	472	VIP-CAB-FLK10/0,14/0,5M	2318305	500
UM 45-FLK50/Front/Q	2959557	528	UT 4-MTD-R/CVC 690/SET	2901667	12	VIP-2/SC/HD15SUB/F	2322401	539	VIP-CAB-FLK10/0,14/1,0M	2318318	500
UM- 8 RELS/KSR-G24/21/MT/PLC	2962463	497				VIP-2/SC/HD15SUB/M	2322326	539	VIP-CAB-FLK10/0,14/1,5M	2318321	500
UM- 8 RM/RT-G24/21/PLC	2968386	493	V			VIP-2/SC/PDM-2/16	2315256	548	VIP-CAB-FLK10/0,14/2,0M	2318334	500
UM- 8RM/KSR-G24/21/MS/PLC	2900890	498	V- 12- 24UC	2833864	388	VIP-2/SC/PDM-2/24	2315269	548	VIP-CAB-FLK10/0,14/3,0M	2318347	500
UM- 8RM/KSR-G24/21/MS/SI/PLC	2900893	499	V- 48- 60UC	2833877	388	VIP-2/SC/PDM-2/32	2315272	548	VIP-CAB-FLK10/0,14/4,0M	2318350	500
UM- 8RM/KSR-G24/21/SI/PLC	2900892	499	V- 120-230UC	2833980	388	VIP-2/SC/PDM-2/48	2903717	548	VIP-CAB-FLK10/0,14/6,0M	2318363	500
			V- 12- 24UC	2833864	388						
UM-16 RELS/KSR-G24/21/E/MT/PLC	2962379	497	V- 48- 60UC	2833877	388	VIP-3/PT/D25SUB/F	2903782	535	VIP-CAB-FLK14-0,14/...	2318457	500
UM-16 RELS/KSR-G24/21/MT/PLC	2962382	497	V-120-230UC	2833880	388	VIP-3/PT/D25SUB/F/LED	2904265	535	VIP-CAB-FLK14/0,14/0,5M	2318398	500
UM-25 FLK26/Front/Q	2959528	528	V-120-230UC	2833980	388	VIP-3/PT/D25SUB/M	2903781	535	VIP-CAB-FLK14/0,14/1,0M	2318392	500
UM-32 RM/RT-G24/21/PLC	2968373	493	V3- 12- 24UC	2833929	388	VIP-3/PT/D25SUB/M/LED	2904260	535	VIP-CAB-FLK14/0,14/1,5M	2318402	500
			V3- 48- 60UC	2833932	388						
UM-32RM/KSR-G24/21/MS/PLC	2900891	498	V3-120-230UC	2833945	388	VIP-3/PT/D37SUB/F	2903784	535	VIP-CAB-FLK14/0,14/2,0M	2318415	500
UM-DELTA V/A/SI	5603256	435	VFD 5007 IL IB	2701054	50	VIP-3/PT/D37SUB/F/LED	2904266	535	VIP-CAB-FLK14/0,14/3,0M	2318428	500
UM-DELTA V/A/SI/BFI/TP	5603258	435	VFD 5015 IL IB	2701055	51	VIP-3/PT/D37SUB/M	2903783	535	VIP-CAB-FLK14/0,14/4,0M	2318431	500
UM-DELTA V/D/SI	5603255	435				VIP-3/PT/D37SUB/M/HW/C300	2904276	439	VIP-CAB-FLK14/0,14/6,0M	2318444	500
			VFD 5022 IL IB	2701057	51						
UM-DELTA V/D/SI/BFI/TP	5603257	435	VFD 5040 IL IB	2701058	51	VIP-3/PT/D37SUB/M/LED	2904261	535	VIP-CAB-FLK14/16/0,5M/S7	2904514	457
UMK- 1 OM-R/AMS	2970882	553	VIP-2/PT/D 9SUB/F	2903778	534	VIP-3/PT/D50SUB/F	2903786	535	VIP-CAB-FLK14/16/1,0M/S7	2904515	457
UMK- 4 OM-R/MF	2972873	553	VIP-2/PT/D 9SUB/M/LED	2904263	535	VIP-3/PT/D50SUB/F/LED	2904267	535	VIP-CAB-FLK14/16/1,5M/S7	2904516	457
UMK- 4 OM-R/MF/P	2972873	553	VIP-2/PT/D 9SUB/M	2903777	534	VIP-3/PT/D50SUB/M	2903785	535	VIP-CAB-FLK14/16/10,0M/S7	2904524	457
			VIP-2/PT/D 9SUB/M/LED	2904258	535						
UMK- 4 RM 5DC	2972819	550	VIP-2/PT/D15SUB/F	2903780	534	VIP-3/PT/D50SUB/M/LED	2904262	535	VIP-CAB-FLK14/16/2,0M/S7	2904517	457
UMK- 4 RM 12DC	2972822	550	VIP-2/PT/D15SUB/F/LED	2904263	535	VIP-3/PT/FLK14/8IM/LED/PLC	2904281	479	VIP-CAB-FLK14/16/2,5M/S7	2904518	457
UMK- 4 RM 24	2971344	550	VIP-2/PT/D15SUB/M	2903779	534	VIP-3/PT/FLK14/8IM/PLC	2904282	479	VIP-CAB-FLK14/16/3,0M/S7	2904519	457
UMK- 4 RM 24DC	2972835	550	VIP-2/PT/D15SUB/M/LED	2904259	535	VIP-3/PT/FLK26	2903791	527	VIP-CAB-FLK14/16/4,0M/S7	2904520	457

Index

Alphabetical

Type	Order No.	Page	Type	Order No.	Page	Type	Order No.	Page
VIP-CAB-FLK14/FR/OE/0,14/1,0M	2900123	502	VIP-PA-FLK14/ 2,5M/S7	2322692	449			
VIP-CAB-FLK14/FR/OE/0,14/1,5M	2900125	502	VIP-PA-FLK14/ 3,0M/S7	2322702	449			
VIP-CAB-FLK14/FR/OE/0,14/2,0M	2900126	502	VIP-PA-FLK14/ 4,0M/S7	2322715	449			
VIP-CAB-FLK14/FR/OE/0,14/3,0M	2900127	502	VIP-PA-FLK14/ 5,0M/S7	2322728	449			
VIP-CAB-FLK14/FR/OE/0,14/4,0M	2900128	502	VIP-PA-FLK14/ 6,0M/S7	2322731	449			
VIP-CAB-FLK14/FR/OE/0,14/6,0M	2900129	502	VIP-PA-FLK14/ 7,0M/S7	2322744	449			
VIP-CAB-FLK16-0,14/...	2318538	500	VIP-PA-FLK14/ 8,0M/S7	2322757	449			
VIP-CAB-FLK16/0,14/0,5M	2318460	500	VIP-PA-FLK14/10,0M/S7	2322760	449			
VIP-CAB-FLK16/0,14/1,0M	2318473	500	VIP-PA-FLK50-4X14-S7/...	2900886	449			
VIP-CAB-FLK16/0,14/1,5M	2318486	500	VIP-PA-FLK50-S7/...	2900885	448			
VIP-CAB-FLK16/0,14/2,0M	2318499	500	VIP-PA-FLK50/ 0,5M/S7	2322443	448			
VIP-CAB-FLK16/0,14/3,0M	2318509	500	VIP-PA-FLK50/ 1,0M/S7	2322456	448			
VIP-CAB-FLK16/0,14/4,0M	2318512	500	VIP-PA-FLK50/ 1,5M/S7	2322469	448			
VIP-CAB-FLK16/0,14/6,0M	2318525	500	VIP-PA-FLK50/ 2,0M/S7	2321800	448			
VIP-CAB-FLK16/FR/OE/0,14/0,5M	2900130	502	VIP-PA-FLK50/ 2,5M/S7	2322472	448			
VIP-CAB-FLK16/FR/OE/0,14/1,0M	2900131	502	VIP-PA-FLK50/ 3,0M/S7	2322485	448			
VIP-CAB-FLK16/FR/OE/0,14/1,5M	2900132	502	VIP-PA-FLK50/ 4,0M/S7	2322498	448			
VIP-CAB-FLK16/FR/OE/0,14/2,0M	2900133	502	VIP-PA-FLK50/ 5,0M/S7	2322508	448			
VIP-CAB-FLK16/FR/OE/0,14/3,0M	2900134	502	VIP-PA-FLK50/ 6,0M/S7	2322511	448			
VIP-CAB-FLK16/FR/OE/0,14/4,0M	2900135	502	VIP-PA-FLK50/ 7,0M/S7	2322524	448			
VIP-CAB-FLK16/FR/OE/0,14/6,0M	2900136	502	VIP-PA-FLK50/ 8,0M/S7	2322537	448			
VIP-CAB-FLK20-0,14/...	2318619	500	VIP-PA-FLK50/10,0M/S7	2322540	448			
VIP-CAB-FLK20/0,14/0,5M	2318541	500	VIP-PA-FLK50/4X14/ 0,5M/S7	2322553	449			
VIP-CAB-FLK20/0,14/1,0M	2318554	500	VIP-PA-FLK50/4X14/ 1,0M/S7	2322566	449			
VIP-CAB-FLK20/0,14/1,5M	2318567	500	VIP-PA-FLK50/4X14/ 1,5M/S7	2322579	449			
VIP-CAB-FLK20/0,14/2,0M	2318570	500	VIP-PA-FLK50/4X14/ 2,0M/S7	2321910	449			
VIP-CAB-FLK20/0,14/3,0M	2318583	500	VIP-PA-FLK50/4X14/ 2,5M/S7	2322582	449			
VIP-CAB-FLK20/0,14/4,0M	2318596	500	VIP-PA-FLK50/4X14/ 3,0M/S7	2322595	449			
VIP-CAB-FLK20/0,14/6,0M	2318606	500	VIP-PA-FLK50/4X14/ 4,0M/S7	2322605	449			
VIP-CAB-FLK20/FR/OE/0,14/0,5M	2900138	503	VIP-PA-FLK50/4X14/ 5,0M/S7	2322618	449			
VIP-CAB-FLK20/FR/OE/0,14/1,0M	2900139	503	VIP-PA-FLK50/4X14/ 6,0M/S7	2322621	449			
VIP-CAB-FLK20/FR/OE/0,14/1,5M	2900141	503	VIP-PA-FLK50/4X14/ 7,0M/S7	2322634	449			
VIP-CAB-FLK20/FR/OE/0,14/2,0M	2900142	503	VIP-PA-FLK50/4X14/ 8,0M/S7	2322647	449			
VIP-CAB-FLK20/FR/OE/0,14/3,0M	2900143	503	VIP-PA-FLK50/4X14/10,0M/S7	2322650	449			
VIP-CAB-FLK20/FR/OE/0,14/4,0M	2900144	503	VS-937/...	1402611	48			
VIP-CAB-FLK20/FR/OE/0,14/6,0M	2900145	503						
VIP-CAB-FLK26-0,14/...	2318693	501						
VIP-CAB-FLK26/0,14/0,5M	2318622	501						
VIP-CAB-FLK26/0,14/1,0M	2318635	501						
VIP-CAB-FLK26/0,14/1,5M	2318648	501						
VIP-CAB-FLK26/0,14/2,0M	2318651	501	ZB 15:UNBEDRUCKT	0811972	318			
VIP-CAB-FLK26/0,14/3,0M	2318664	501	ZB 5 :UNBEDRUCKT	1050004	318			
VIP-CAB-FLK26/0,14/4,0M	2318677	501	ZB 6.LGS:FORTL.ZAHLEN	1051016	368			
VIP-CAB-FLK26/0,14/6,0M	2318680	501	ZB 6:UNBEDRUCKT	1051003	318			
VIP-CAB-FLK34-0,14/...	2318774	501						
VIP-CAB-FLK34/0,14/0,5M	2318703	501						
VIP-CAB-FLK34/0,14/1,0M	2318716	501						
VIP-CAB-FLK34/0,14/1,5M	2318729	501						
VIP-CAB-FLK34/0,14/2,0M	2318732	501						
VIP-CAB-FLK34/0,14/3,0M	2318745	501						
VIP-CAB-FLK34/0,14/4,0M	2318758	501						
VIP-CAB-FLK34/0,14/6,0M	2318761	501						
VIP-CAB-FLK40-0,14/...	2318855	501						
VIP-CAB-FLK40/0,14/0,5M	2318787	501						
VIP-CAB-FLK40/0,14/1,0M	2318790	501						
VIP-CAB-FLK40/0,14/1,5M	2318800	501						
VIP-CAB-FLK40/0,14/2,0M	2318813	501						
VIP-CAB-FLK40/0,14/3,0M	2318826	501						
VIP-CAB-FLK40/0,14/4,0M	2318839	501						
VIP-CAB-FLK40/0,14/6,0M	2318842	501						
VIP-CAB-FLK50-0,14/...	2318936	501						
VIP-CAB-FLK50/0,14/0,5M	2318868	501						
VIP-CAB-FLK50/0,14/1,0M	2318871	501						
VIP-CAB-FLK50/0,14/1,5M	2318884	501						
VIP-CAB-FLK50/0,14/2,0M	2318897	501						
VIP-CAB-FLK50/0,14/3,0M	2318907	501						
VIP-CAB-FLK50/0,14/4,0M	2318910	501						
VIP-CAB-FLK50/0,14/6,0M	2318923	501						
VIP-CAB-FLK50/FR/OE/0,14/0,5M	2900146	503						
VIP-CAB-FLK50/FR/OE/0,14/1,0M	2900147	503						
VIP-CAB-FLK50/FR/OE/0,14/1,5M	2900148	503						
VIP-CAB-FLK50/FR/OE/0,14/2,0M	2900149	503						
VIP-CAB-FLK50/FR/OE/0,14/3,0M	2900150	503						
VIP-CAB-FLK50/FR/OE/0,14/4,0M	2900151	503						
VIP-CAB-FLK50/FR/OE/0,14/6,0M	2900152	503						
VIP-PA-FLK14-S7/...	2900887	449						
VIP-PA-FLK14/ 0,5M/S7	2322663	449						
VIP-PA-FLK14/ 1,0M/S7	2322676	449						
VIP-PA-FLK14/ 1,5M/S7	2322689	449						
VIP-PA-FLK14/ 2,0M/S7	2321790	449						

Z



Компания «Life Electronics» занимается поставками электронных компонентов импортного и отечественного производства от производителей и со складов крупных дистрибьюторов Европы, Америки и Азии.

С конца 2013 года компания активно расширяет линейку поставок компонентов по направлению коаксиальный кабель, кварцевые генераторы и конденсаторы (керамические, пленочные, электролитические), за счёт заключения дистрибьюторских договоров

Мы предлагаем:

- Конкуренспособные цены и скидки постоянным клиентам.
- Специальные условия для постоянных клиентов.
- Подбор аналогов.
- Поставку компонентов в любых объемах, удовлетворяющих вашим потребностям.
- Приемлемые сроки поставки, возможна ускоренная поставка.
- Доставку товара в любую точку России и стран СНГ.
- Комплексную поставку.
- Работу по проектам и поставку образцов.
- Формирование склада под заказчика.
- Сертификаты соответствия на поставляемую продукцию (по желанию клиента).
- Тестирование поставляемой продукции.
- Поставку компонентов, требующих военную и космическую приемку.
- Входной контроль качества.
- Наличие сертификата ISO.

В составе нашей компании организован Конструкторский отдел, призванный помогать разработчикам, и инженерам.

Конструкторский отдел помогает осуществить:

- Регистрацию проекта у производителя компонентов.
- Техническую поддержку проекта.
- Защиту от снятия компонента с производства.
- Оценку стоимости проекта по компонентам.
- Изготовление тестовой платы монтаж и пусконаладочные работы.



Тел: +7 (812) 336 43 04 (многоканальный)

Email: org@lifeelectronics.ru