

LOC		DIST		REVISIONS			
P	LTN	DESCRIPTION	DATE	DMN	APVD		
GP	00						
E2		ADDED NEW DASH NUMBER 2-5	03MAY2012	CZ	SZ		
E3		REVISED	16FEB2013	ML	SZ		
E4		ADD NEW DASH NUMBER 2-6	09MAY2014	CZ	SZ		

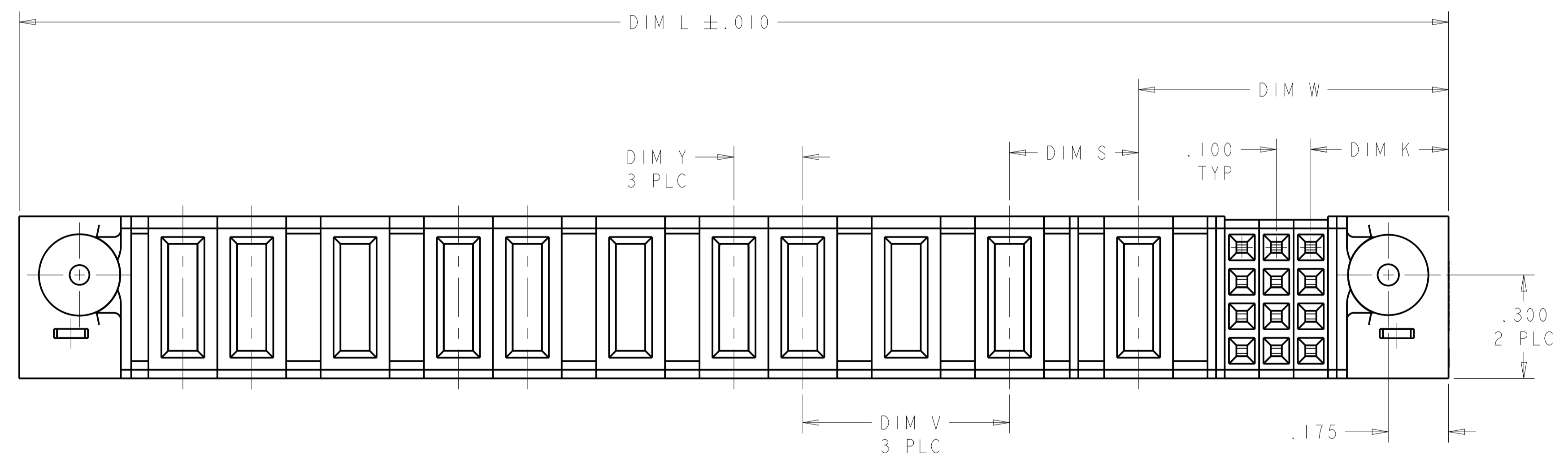

- 1 "AMP", PART NUMBER, AND DATE CODE TO BE MARKED IN AREA SHOWN.
- 2 MATERIAL: HOUSING - GLASS FILLED HIGH TEMP THERMO PLASTIC, UL94 V-O.
SIGNAL CONTACT - HIGH CONDUCTIVITY COPPER ALLOY
POWER CONTACT - HIGH CONDUCTIVITY COPPER ALLOY
- 3 CONTACT PLATING: NOBLE METAL PLATED ON THE CONTACT FUNCTIONAL AREA OF POWER AND SIGNAL CONTACTS.
- 4 MECHANICAL CONNECTOR KEEP OUT ZONE.
- 5 DATUM AND BASIC DIMENSIONS ESTABLISHED BY CUSTOMER.
- 6 PCB - ALL HOLE DIAMETERS ARE FINISHED HOLE SIZES.
- 7 PCB - .0453 +/- .0010 DRILLED HOLES PLATED WITH .0003 MIN Sn OVER .001 TO .003 PLATING TO ACHIEVE A .040 DIA. HOLE.
- 8 FOR DETAIL DIM PLEASE REFER TO TABLE

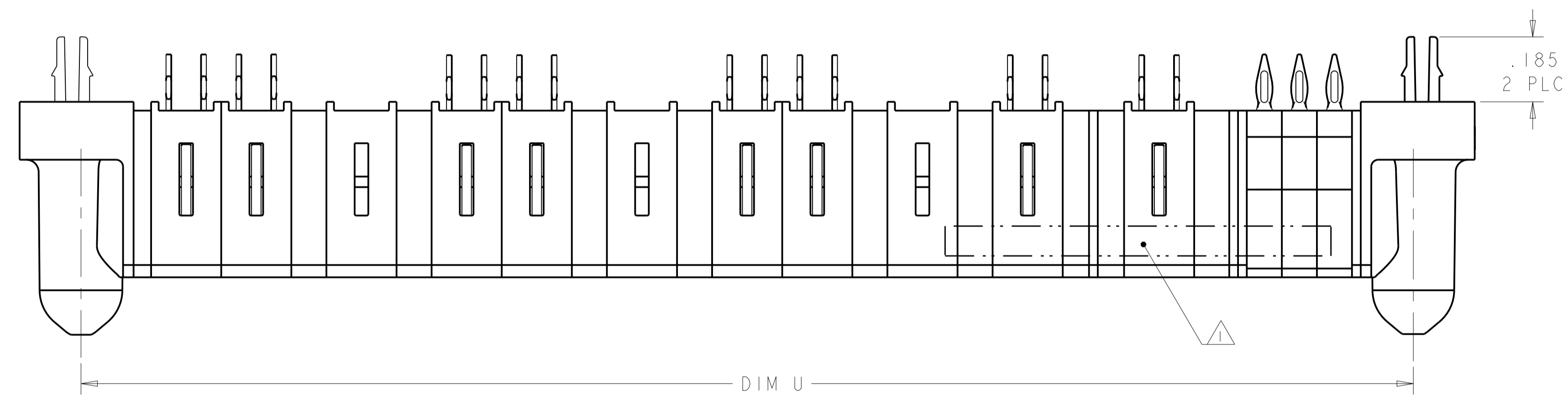
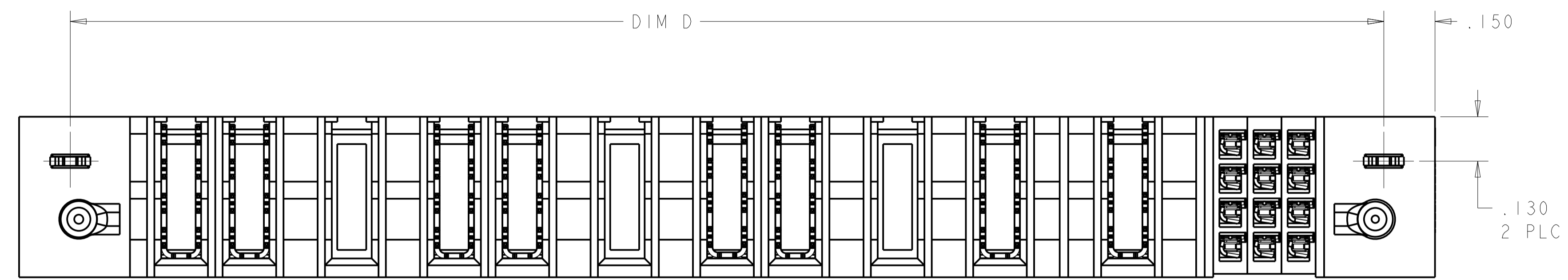
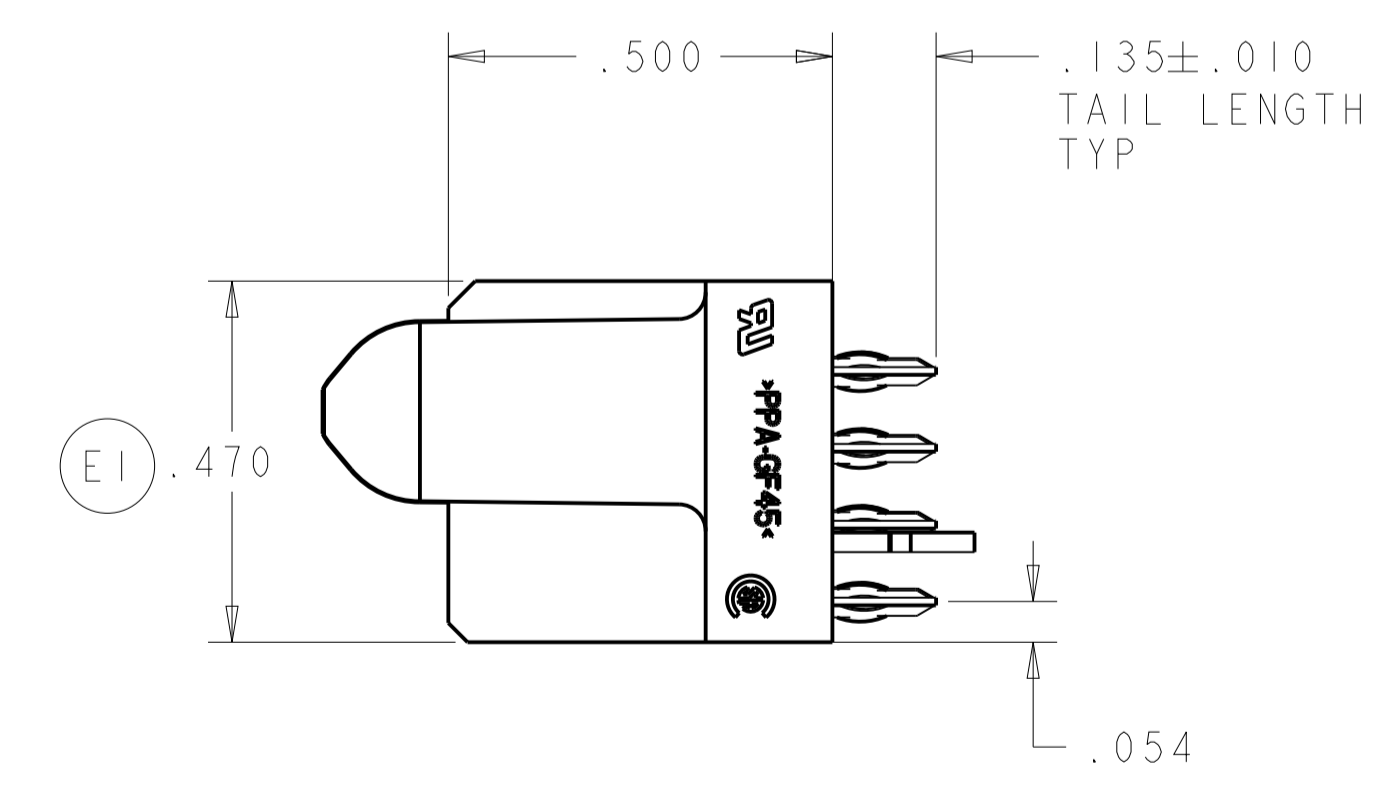

THIS DRAWING IS A CONTROLLED DOCUMENT.		DMN R. GRZYBOWSKI 02MAY05	TE Connectivity VERTICAL RECEPTACLE WITH GUIDES MULTI-BEAM XL	
DIMENSIONS: INCHES		CHK M. PERCHERKE 02MAY05		
TOLERANCES UNLESS OTHERWISE SPECIFIED:		APVD M. PERCHERKE 02MAY05	NAME	
0 PLC ±. 1 PLC ±.01 2 PLC ±.01 3 PLC ±.005 4 PLC ±.0020 ANGLES ±.2°		PRODUCT SPEC 108-1973	SIZE CAGE CODE DRAWING NO	
MATERIAL		APPLICATION SPEC 114-13038	RESTRICTED TO	
FINISH		WEIGHT	A100779C=6450541	
CUSTOMER DRAWING		SCALE 4:1	SHEET 1 OF 12 REV E.4	

THIS DRAWING IS UNPUBLISHED. RELEASED FOR PUBLICATION 20
 © COPYRIGHT 20 BY - ALL RIGHTS RESERVED.

LOC		DIST		REVISIONS			
GP	00	P	LTN	DESCRIPTION	DATE	DWN	APVD
-	-	-	-	SEE SHEET 1	-	-	-

E4	-	-	2.400	.250	.375	2.750	1.050	2.450	24S + 6P	2-6450541-6
	-	-	-	-	.425	2.350	-	2.050	64S	2-6450541-5
	-	-	1.100	-	.375	1.450	-	1.150	32S	2-6450541-4
	-	-	3.800	.250	.375	4.150	3.450	3.850	120S + 2P	2-6450541-3
	-	-	1.500	.250	.375	1.850	0.625	1.550	8S + 4P	2-6450541-2
	-	-	1.600	.250	.375	1.950	0.725	1.650	12S + 4P	2-6450541-1
	-	-	6.075	.200	.375	6.425	1.375	6.125	36S + 24P	2-6450541-0
	-	-	4.025	\triangle	.375	4.375	2.125	4.075	60S + 8P	1-6450541-9
	-	-	2.925	.200	.375	3.275	1.025	2.975	24S + 10P	1-6450541-8
	-	-	2.400	.250	.375	2.750	1.050	-	24S + 6P	1-6450541-7
	-	-	1.750	.200	.375	2.100	.650	-	8S + 6HDP	1-6450541-4
	-	-	0.950	.200	.375	1.300	.650	-	8S + 2HDP	1-6450541-3
	-	-	1.700	.250	.375	2.050	.850	-	16S + 4P	1-6450541-2
	-	-	2.850	.200	.375	3.200	.950	-	20S + 10HDP	6450541-7
	-	-	2.900	.250	.375	3.250	1.050	-	24S + 8P	6450541-5
	-	-	2.400	.250	.375	2.750	1.050	-	24S + 6P	6450541-4
	-	-	1.900	.250	.375	2.250	1.050	-	24S + 4P	6450541-3
	-	-	4.400	.250	.375	4.750	1.050	-	24S + 14P	6450541-2
	.200	.600	3.800	.375	.400	4.150	.900	3.850	12S + 11P	6450541-1
	DIM Y	DIM V	DIM U	DIM S	DIM K	DIM L	DIM W	DIM D	DESCRIPTION	PART NUMBER

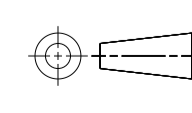
THIS DRAWING IS A CONTROLLED DOCUMENT.		DWN R. GRZYBOWSKI 02MAY05	 TE Connectivity	
DIMENSIONS: INCHES		CHK M. PERCHERKE 02MAY05		
TOLERANCES UNLESS OTHERWISE SPECIFIED:		APVD M. PERCHERKE 02MAY05	NAME VERTICAL RECEPTACLE WITH GUIDES MULTI-BEAM XL	
0 PLC ±. 1 PLC ±. 2 PLC ±.01 3 PLC ±.005 4 PLC ±.0020 ANGLES ±.020		PRODUCT SPEC 108-1973	SIZE A1	
		APPLICATION SPEC 114-13038	CAGE CODE DRAWING NO 6450541	
MATERIAL		FINISH	RESTRICTED TO	
-		-	A100779	
CUSTOMER DRAWING		SCALE 4:1		SHEET 2 OF 12 REV E4

LOC	DIST	REVISIONS			
P	LTN	DESCRIPTION	DATE	OWN	APVD
GP	00	SEE SHEET 1			

PART NUMBER	ROWS	POWER										SIGNAL						
		P11	P10	P9	P8	P7	P6	P5	P4	P3	P2	P1	3	2	1			
6450541-1	D C B A	GP	GP		GP	GP		GP	GP		GP	GP	GP	GP	GP	GP	GP	GP
12S + 11P																AP	AP	AP
																AP	AP	AP
																AP	AP	AP
																AP	AP	AP

ASSY PART NUMBER	ROWS	POWER														SIGNAL					
		P14	P13	P12	P11	P10	P9	P8	P7	P6	P5	P4	P3	P2	P1	6	5	4	3	2	1
6450541-2	D C B A	GP	GP	GP	GP	GP	GP	GP	GP	GP	GP	GP	GP	GP	GP	GP	GP	GP	GP		
24S + 14P																					

NO CONTACTS LOADED

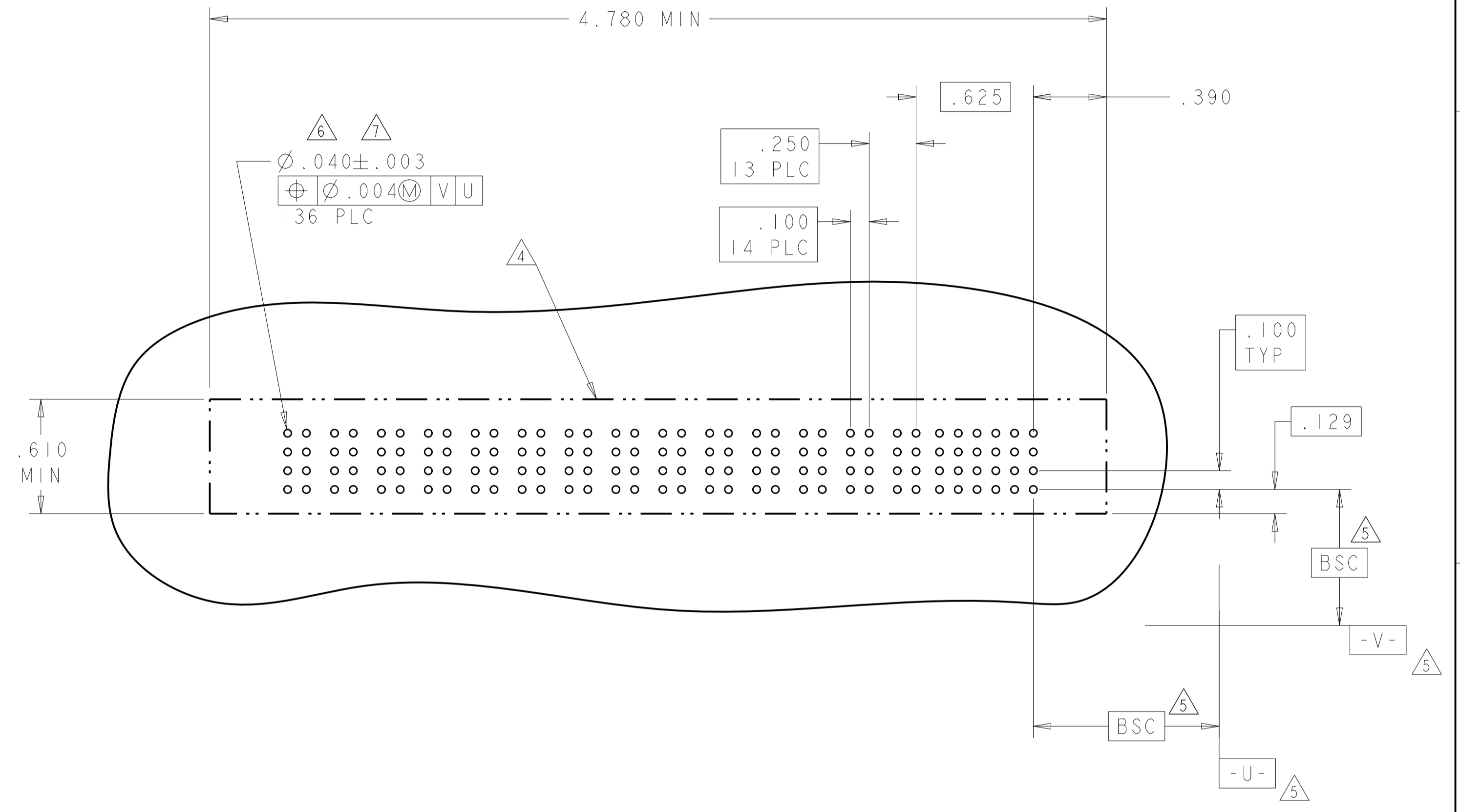
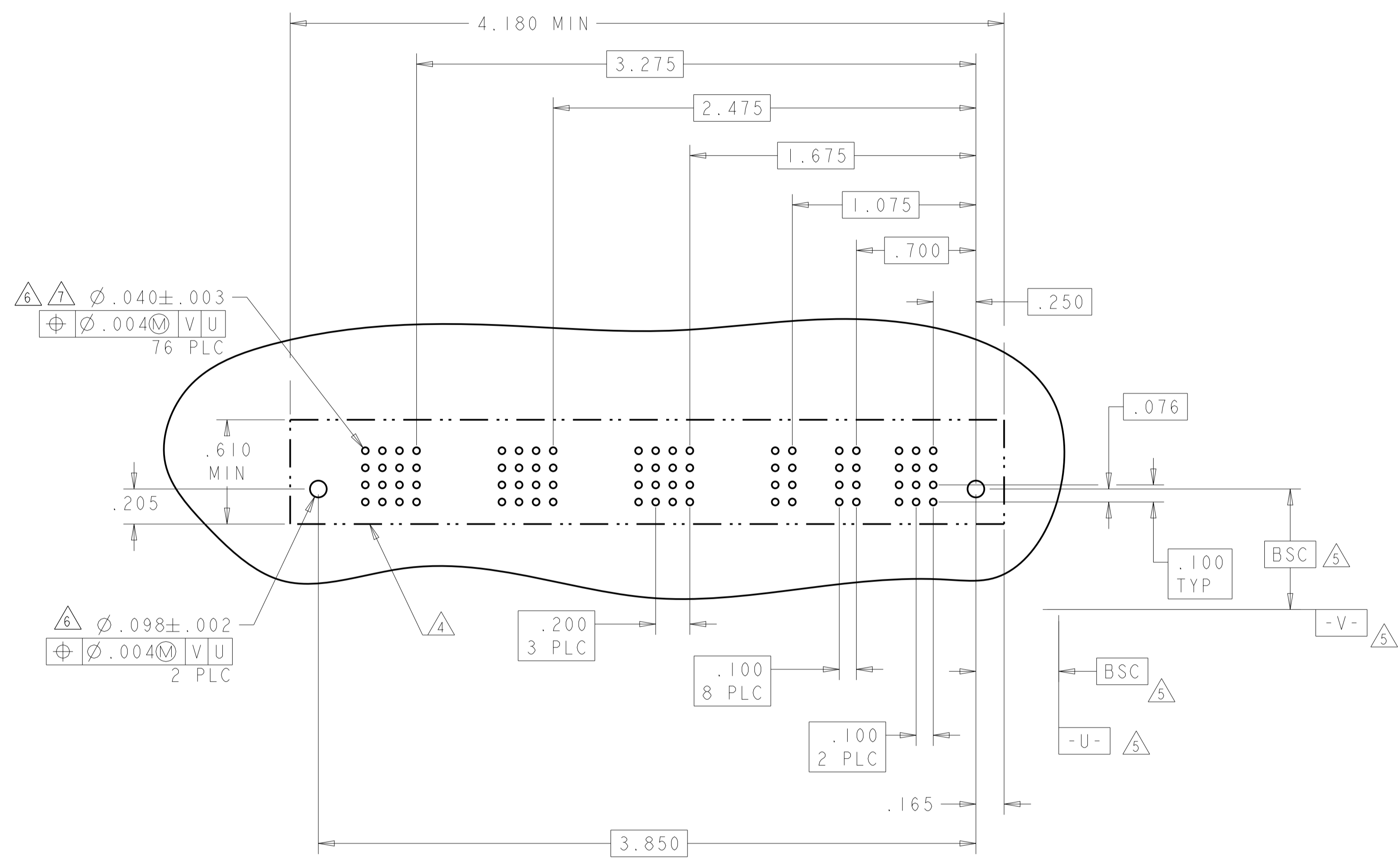

TAIL LENGTH	CODE	DESCRIPTION
.165	HS	STD POWER PRESS FIT CONTACT
.165	BP	SIGNAL PRESS FIT CONTACT
.135	GS	STD POWER PRESSFIT CONTACT
.135	GP	MFBL POWER PRESSFIT CONTACT
.135	AP	SIGNAL PRESSFIT CONTACT

CONTACT TABLE

THIS DRAWING IS A CONTROLLED DOCUMENT.		OWN: R. GRZYBOWSKI 02MAY05	TE Connectivity
DIMENSIONS: INCHES		CHK: M. PERCHERKE 02MAY05	
TOLERANCES UNLESS OTHERWISE SPECIFIED:		APVD: M. PERCHERKE 02MAY05	VERTICAL RECEPTACLE WITH GUIDES MULTI-BEAM XL
0 PLC ± .01		PRODUCT SPEC	
1 PLC ± .01		108-1973	
2 PLC ± .01		APPLICATION SPEC	
3 PLC ± .005		114-13038	SIZE: CAGE CODE DRAWING NO
4 PLC ± .002		WEIGHT	RESTRICTED TO
ANGLES ± .020		FINISH	A100779C=6450541
MATERIAL		CUSTOMER DRAWING	SCALE 4:1 SHEET 3 OF 12 REV E4

LOC	DIST	REV	DATE	BY	APPV
GP	00				

REVISIONS			
REV	DATE	BY	APPV
-	-	-	-
SEE SHEET 1			

ASSY PART NUMBER	ROWS	POWER				SIGNAL						
		P4	P3	P2	PI	6	5	4	3	2	1	
6450541-3	D C B A	GP	GP	GP	GP	AP	AP	AP	AP	AP	AP	AP
		GP	GP	GP	GP	AP	AP	AP	AP	AP	AP	AP
		GP	GP	GP	GP	AP	AP	AP	AP	AP	AP	AP
		GP	GP	GP	GP	AP	AP	AP	AP	AP	AP	AP
24S + 4P												

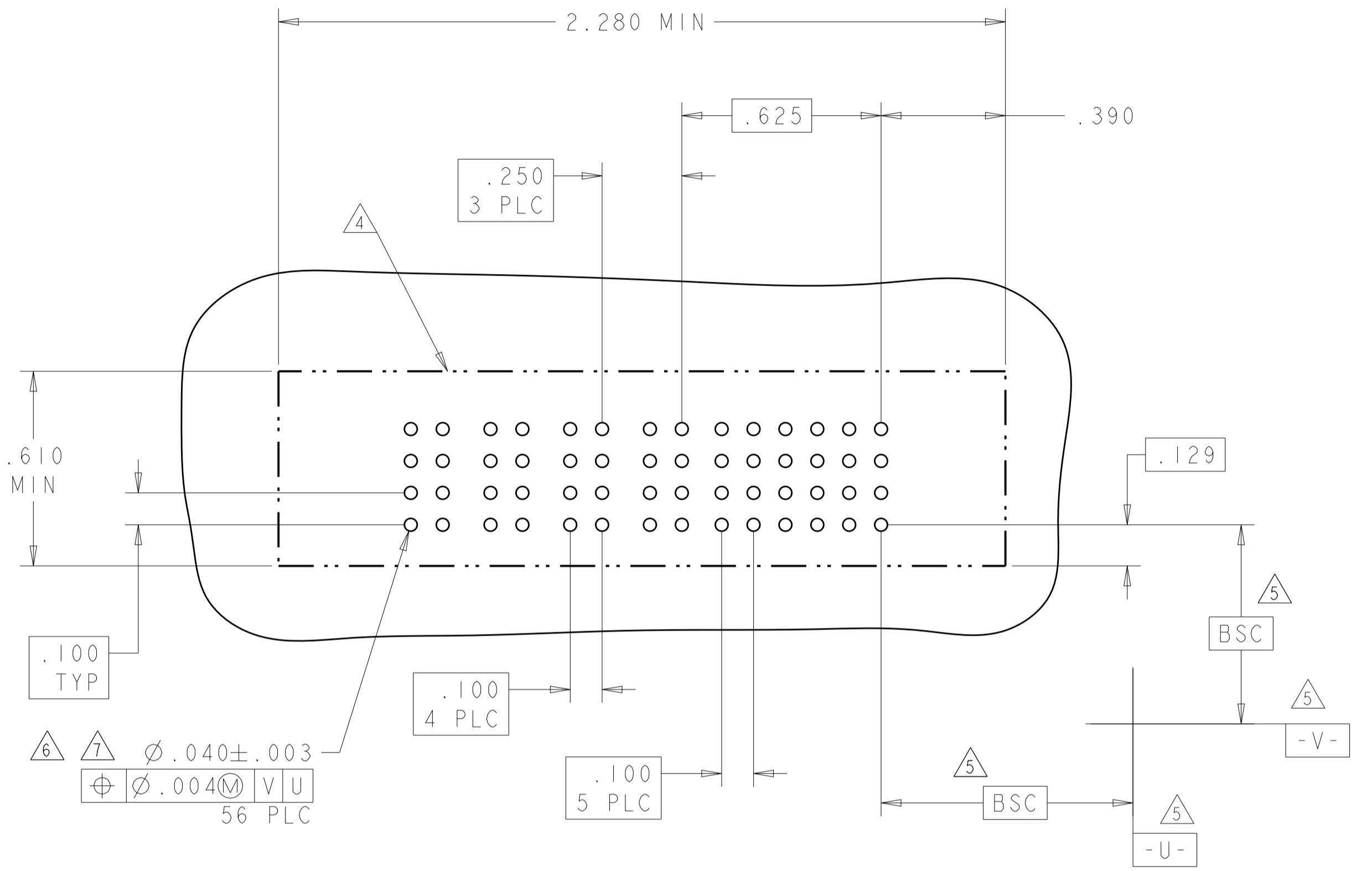

PART NUMBER	ROWS	POWER								SIGNAL					
		P8	P7	P6	P5	P4	P3	P2	PI	6	5	4	3	2	1
6450541-5	D C B A	GP	GP	GP	GP	GP	GP	GP	GP	AP	AP	AP	AP	AP	AP
		GP	GP	GP	GP	GP	GP	GP	GP	AP	AP	AP	AP	AP	AP
		GP	GP	GP	GP	GP	GP	GP	GP	AP	AP	AP	AP	AP	AP
		GP	GP	GP	GP	GP	GP	GP	GP	AP	AP	AP	AP	AP	AP
24S + 8P															

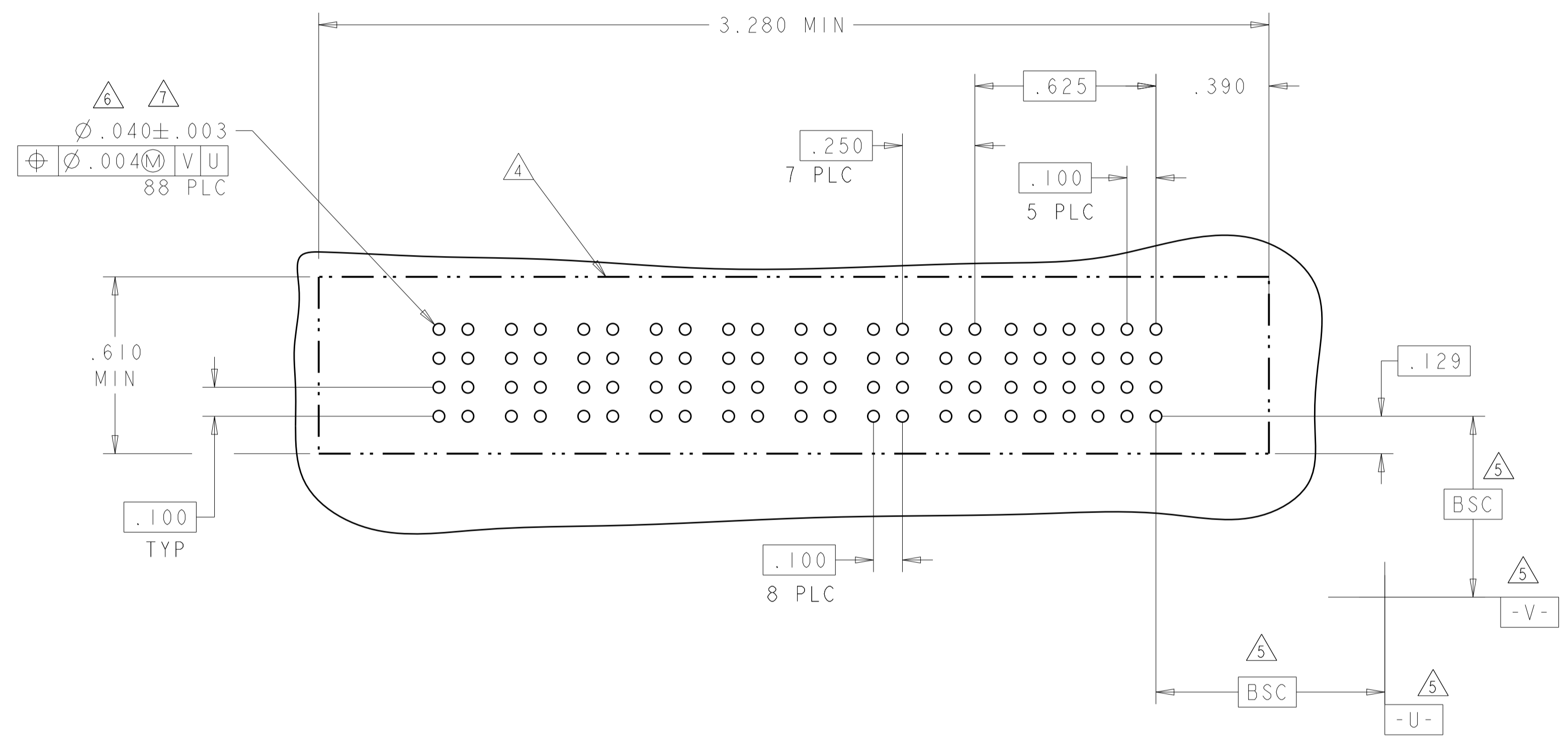

ASSY PART NUMBER	ROWS	POWER						SIGNAL					
		P6	P5	P4	P3	P2	PI	6	5	4	3	2	1
6450541-4	D C B A	GP	GP	GP	GP	GP	GP	AP	AP	AP	AP	AP	AP
		GP	GP	GP	GP	GP	GP	AP	AP	AP	AP	AP	AP
		GP	GP	GP	GP	GP	GP	AP	AP	AP	AP	AP	AP
		GP	GP	GP	GP	GP	GP	AP	AP	AP	AP	AP	AP
24S + 6P													

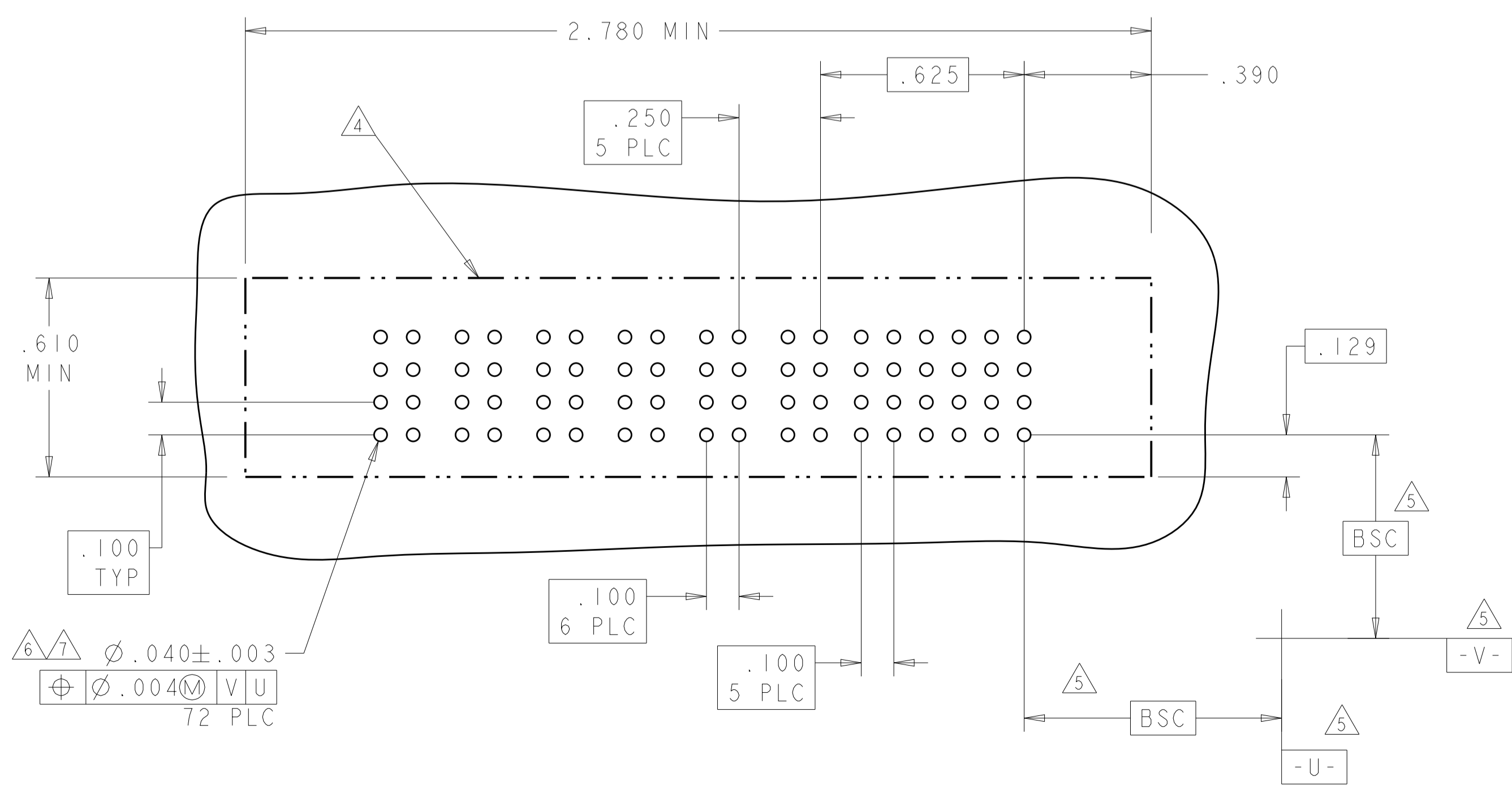

THIS DRAWING IS A CONTROLLED DOCUMENT.		OWN: R. GRZYBOWSKI 02MAY05	 TE Connectivity
DIMENSIONS: INCHES		CHK: M. PERCHERKE 02MAY05	
TOLERANCES UNLESS OTHERWISE SPECIFIED:		APVD: M. PERCHERKE 02MAY05	NAME: VERTICAL RECEPTACLE WITH GUIDES MULTI-BEAM XL
0 PLC ±.01 1 PLC ±.01 2 PLC ±.01 3 PLC ±.01 4 PLC ±.005 5 PLC ±.002 ANGLES ±.020		PRODUCT SPEC: 108-1973	SIZE: CAGE CODE DRAWING NO: A100779
MATERIAL: FINISH:		APPLICATION SPEC: 114-13038	RESTRICTED TO: C=6450541
		WEIGHT: CUSTOMER DRAWING	SCALE: 4:1 SHEET 4 OF 12 REV: E4

LOC	DIST	REVISIONS			
P	LTN	DESCRIPTION	DATE	OWN	APVD
GP	00	SEE SHEET 1			

ASSY PART NUMBER	ROWS	POWER						SIGNAL					
		P6	P5	P4	P3	P2	P1	6	5	4	3	2	1
1-6450541-7	D C B A	GS	GS	GS	GS	GS	GS	AP	AP	AP	AP	AP	AP
24S + 6P								AP	AP	AP	AP	AP	AP

PART NUMBER	ROWS	POWER				SIGNAL		
		P4	P3	P2	P1	3	2	1
2-6450541-1	D C B A	GS	GS	GS	GS	AP	AP	AP
12S + 4P						AP	AP	AP

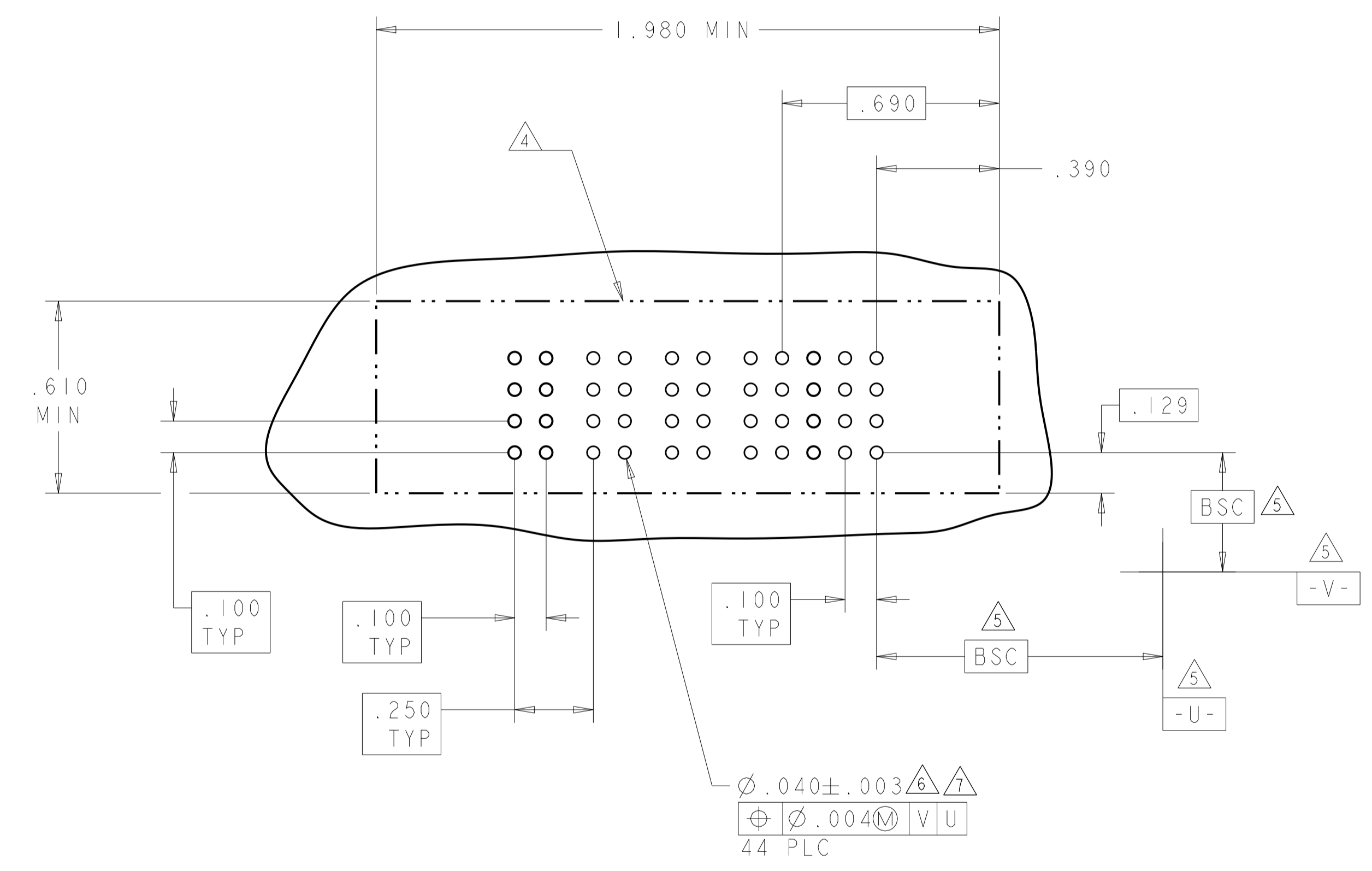
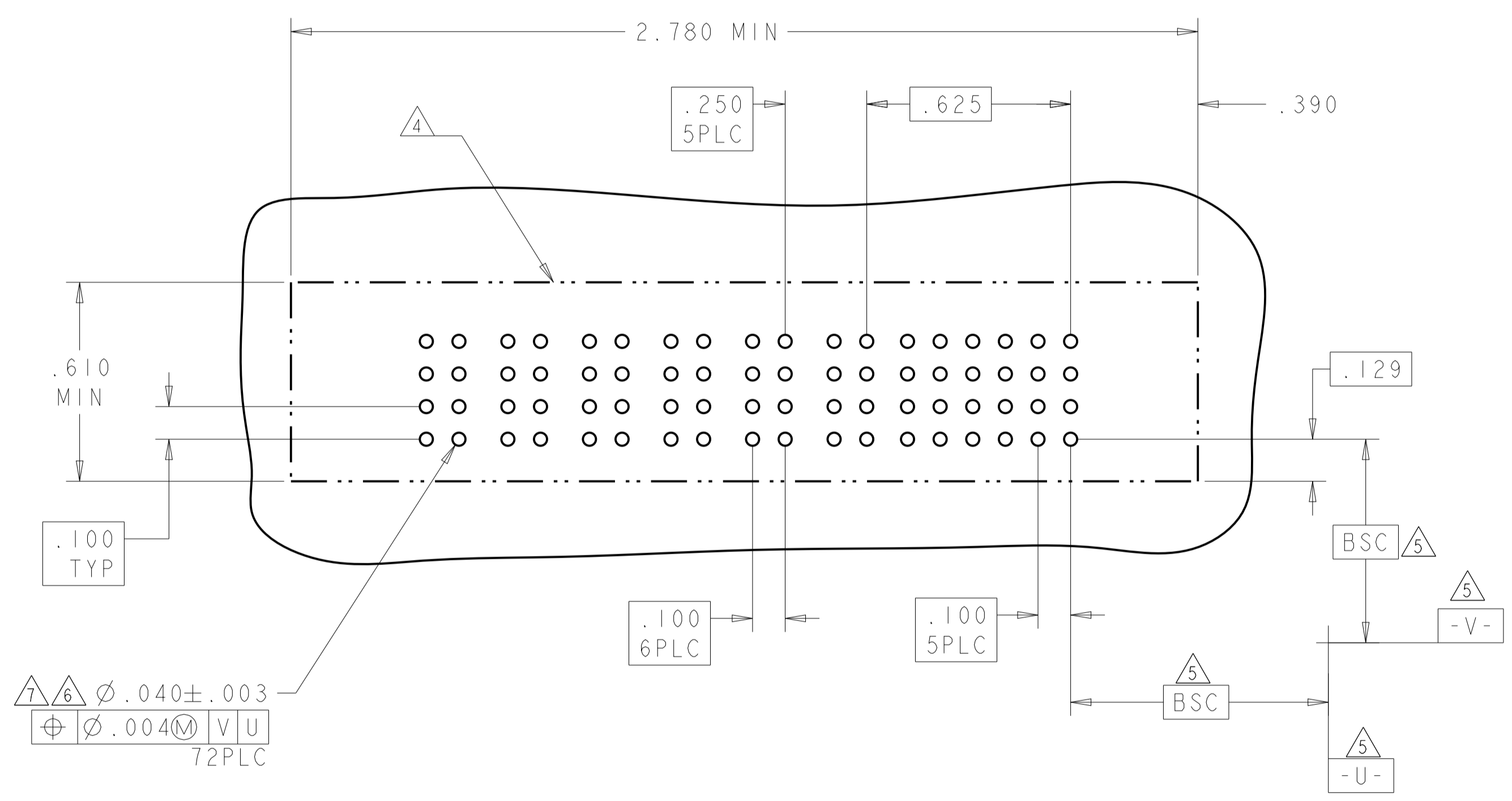

THIS DRAWING IS A CONTROLLED DOCUMENT.

DIMENSIONS: INCHES	TOLERANCES UNLESS OTHERWISE SPECIFIED:	OWN: B. GRZYBOWSKI 02MAY05	CHK: M. PERCHERKE 02MAY05	TE Connectivity VERTICAL RECEPTACLE WITH GUIDES MULTI-BEAM XL									
<table border="1"> <tr><td>0 PLC</td><td>±</td></tr> <tr><td>2 PLC</td><td>±.01</td></tr> <tr><td>3 PLC</td><td>±.005</td></tr> <tr><td>4 PLC</td><td>±.0020</td></tr> </table>	0 PLC	±	2 PLC		±.01	3 PLC	±.005	4 PLC	±.0020	<table border="1"> <tr><td>ANGLES</td><td>±.020</td></tr> </table>	ANGLES	±.020	APVD: M. PERCHERKE 02MAY05
0 PLC	±												
2 PLC	±.01												
3 PLC	±.005												
4 PLC	±.0020												
ANGLES	±.020												
MATERIAL: -	FINISH: -	APPLICATION SPEC: 114-13038	WEIGHT: -	SIZE: A1									
CUSTOMER DRAWING		SCALE: 4:1		SHEET 6 OF 12									

LOC	DIST	REVISIONS			
P	LTH	DESCRIPTION	DATE	DWN	APVD
-	-	SEE SHEET 1	-	-	-

ASSY PART NUMBER	ROWS	POWER										SIGNAL						
		P10	P9	P8	P7	P6	P5	P4	P3	P2	P1	6	5	4	3	2	1	
1-6450541-8	D C B A	GS	GS	GS	GS		GS	GS	GS	GS		AP	AP	AP	AP			
												AP	AP	AP	AP			
												AP	AP	AP	AP			
												AP	AP	AP	AP			
24S + 10P																		

NO CONTACTS LOADED

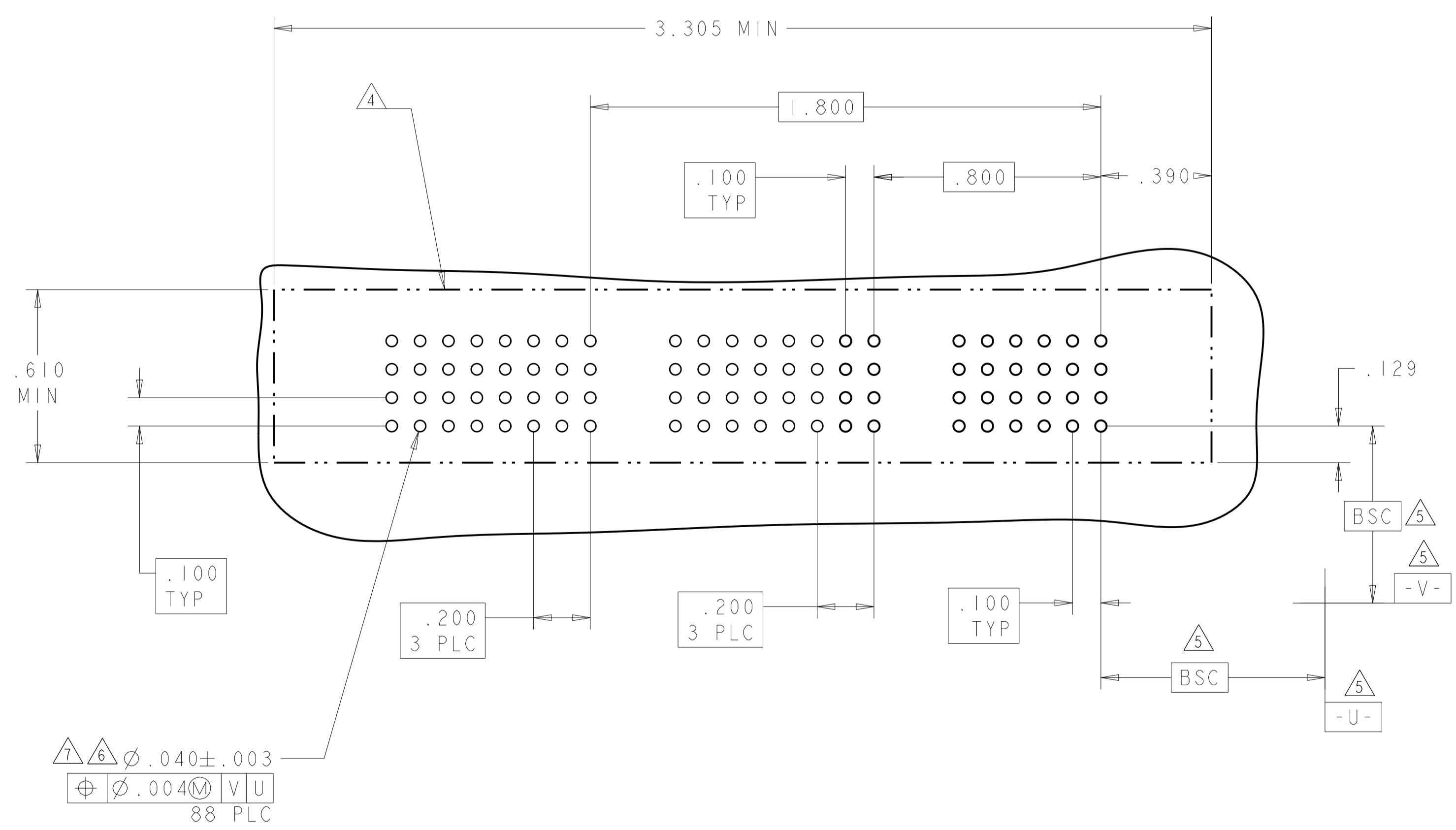

THIS DRAWING IS A CONTROLLED DOCUMENT.		DWN: B. GRZYBOWSKI 02MAY05	TE Connectivity NAME: VERTICAL RECEPTACLE WITH GUIDES MULTI-BEAM XL
DIMENSIONS: INCHES		CHK: M. PERCHERKE 02MAY05	
TOLERANCES UNLESS OTHERWISE SPECIFIED: 0 PLC ±. 1 PLC ±.01 2 PLC ±.01 3 PLC ±.005 4 PLC ±.0020 ANGLES ±.0°		APVD: M. PERCHERKE 02MAY05	PRODUCT SPEC: 108-1973 APPLICATION SPEC: 114-13038 WEIGHT: -
MATERIAL: -		FINISH: -	SIZE: A1 CAGE CODE: 6450541 CUSTOMER DRAWING SCALE: 4:1 SHEET 7 OF 12 REV: E4

LOC		DIST		REVISIONS			
GP	00	P	LTN	DESCRIPTION	DATE	DMN	APVD
		-		SEE SHEET 1			

ASSY PART NUMBER	ROWS	POWER								SIGNAL														
		P8	P7	P6	P5	P4	P3	P2	P1	15	14	13	12	11	10	9	8	7	6	5	4	3	2	1
1-6450541-9	D C B A	GS	GS	GS	GS	GS	GS	GS	GS	AP	AP	AP	AP	AP	AP	AP	AP	AP	AP	AP	AP	AP	AP	AP
		GS	GS	GS	GS	GS	GS	GS	GS	AP	AP	AP	AP	AP	AP	AP	AP	AP	AP	AP	AP	AP	AP	AP
		GS	GS	GS	GS	GS	GS	GS	GS	AP	AP	AP	AP	AP	AP	AP	AP	AP	AP	AP	AP	AP	AP	AP
		GS	GS	GS	GS	GS	GS	GS	GS	AP	AP	AP	AP	AP	AP	AP	AP	AP	AP	AP	AP	AP	AP	AP

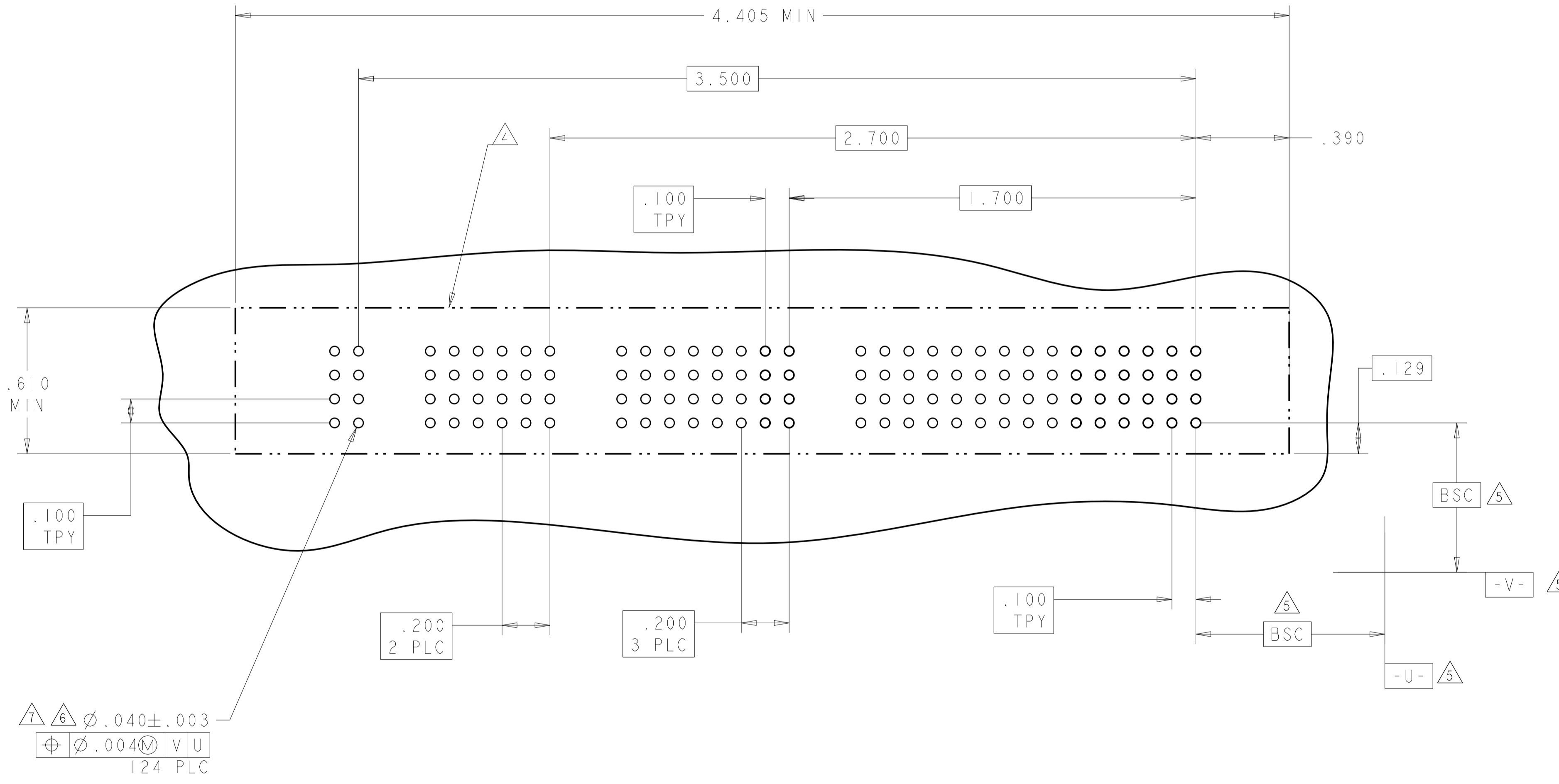
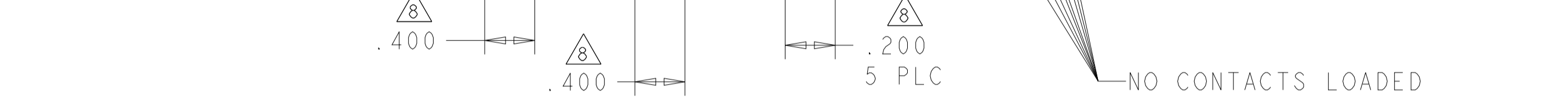

$\Delta \Delta \Delta \phi .040 \pm .003$
 $\oplus \phi .004 \text{ V U}$
 124 PLC

THIS DRAWING IS A CONTROLLED DOCUMENT.		DMN R. GRZYBOWSKI	02MAY05	TE Connectivity
DIMENSIONS: INCHES		CHK M. PERCHERKE	02MAY05	
TOLERANCES UNLESS OTHERWISE SPECIFIED: 0 PLC ± 1 PLC ±.01 2 PLC ±.01 3 PLC ±.005 4 PLC ±.0020 ANGLES ±.020		APVD M. PERCHERKE	02MAY05	NAME VERTICAL RECEPTACLE WITH GUIDES MULTI-BEAM XL
MATERIAL		PRODUCT SPEC	108-1973	SIZE
FINISH		APPLICATION SPEC	114-13038	CAGE CODE
		WEIGHT		DRAWING NO
		CUSTOMER DRAWING		A100779
		SCALE	4:1	SHEET 8 OF 12
		REV	E4	

LOC		DIST		REVISONS			
GP	00	P	LTN	DESCRIPTION	DATE	DMN	APVD
-	-	-	-	SEE SHEET 1	-	-	-

PART NUMBER	ROWS	POWER				SIGNAL	
		P4	P3	P2	P1	2	1
2-6450541-2	D	GS	GS	GS	GS	AP	AP
	C					AP	AP
	B					AP	AP
	A					AP	AP
8S + 4P							

PART NUMBER	ROWS	SIGNAL							
		8	7	6	5	4	3	2	1
2-6450541-4	D	AP	AP	AP	AP	AP	AP	AP	AP
	C	AP	AP	AP	AP	AP	AP	AP	AP
	B	AP	AP	AP	AP	AP	AP	AP	AP
	A	AP	AP	AP	AP	AP	AP	AP	AP
32S									

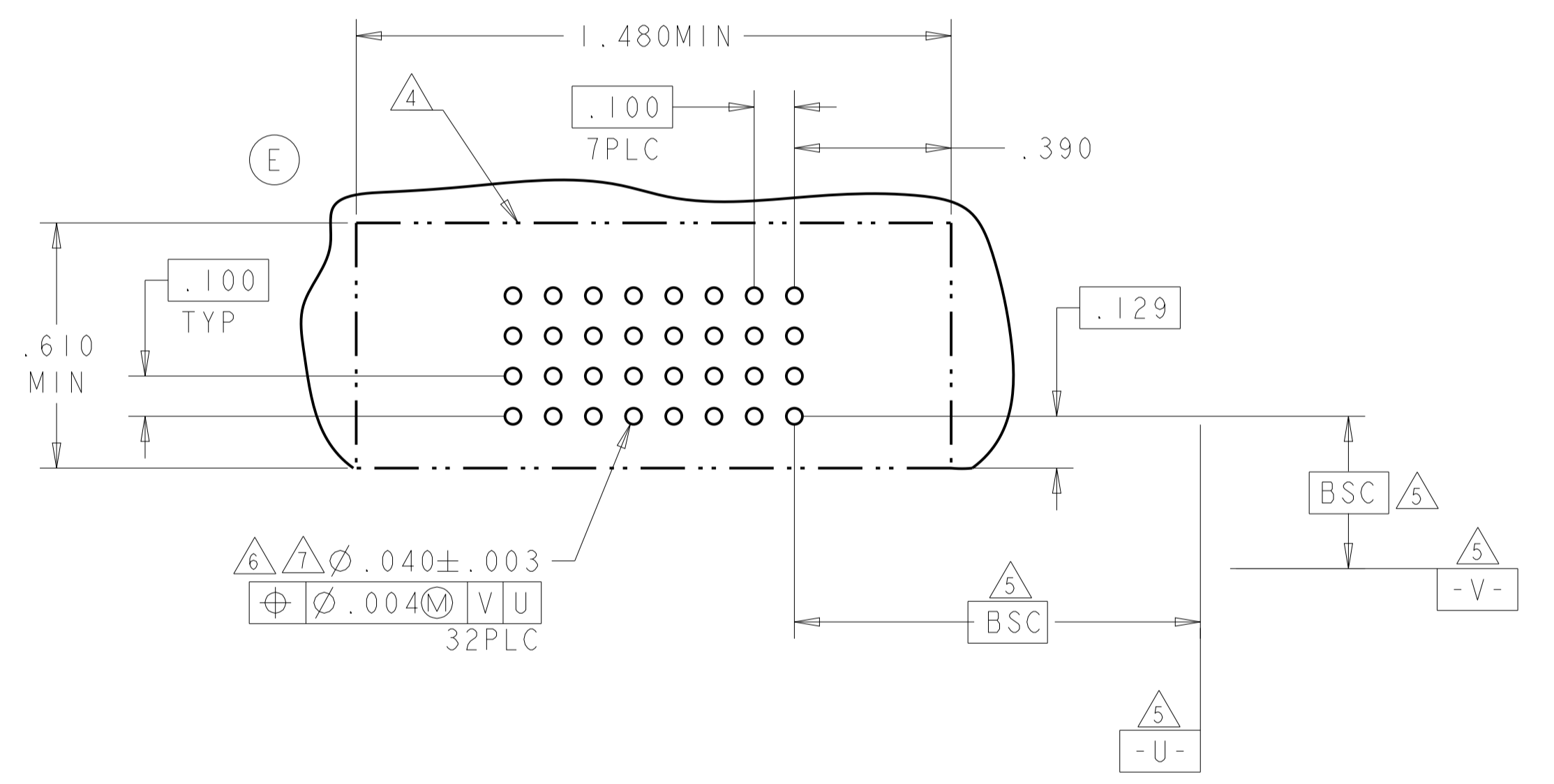
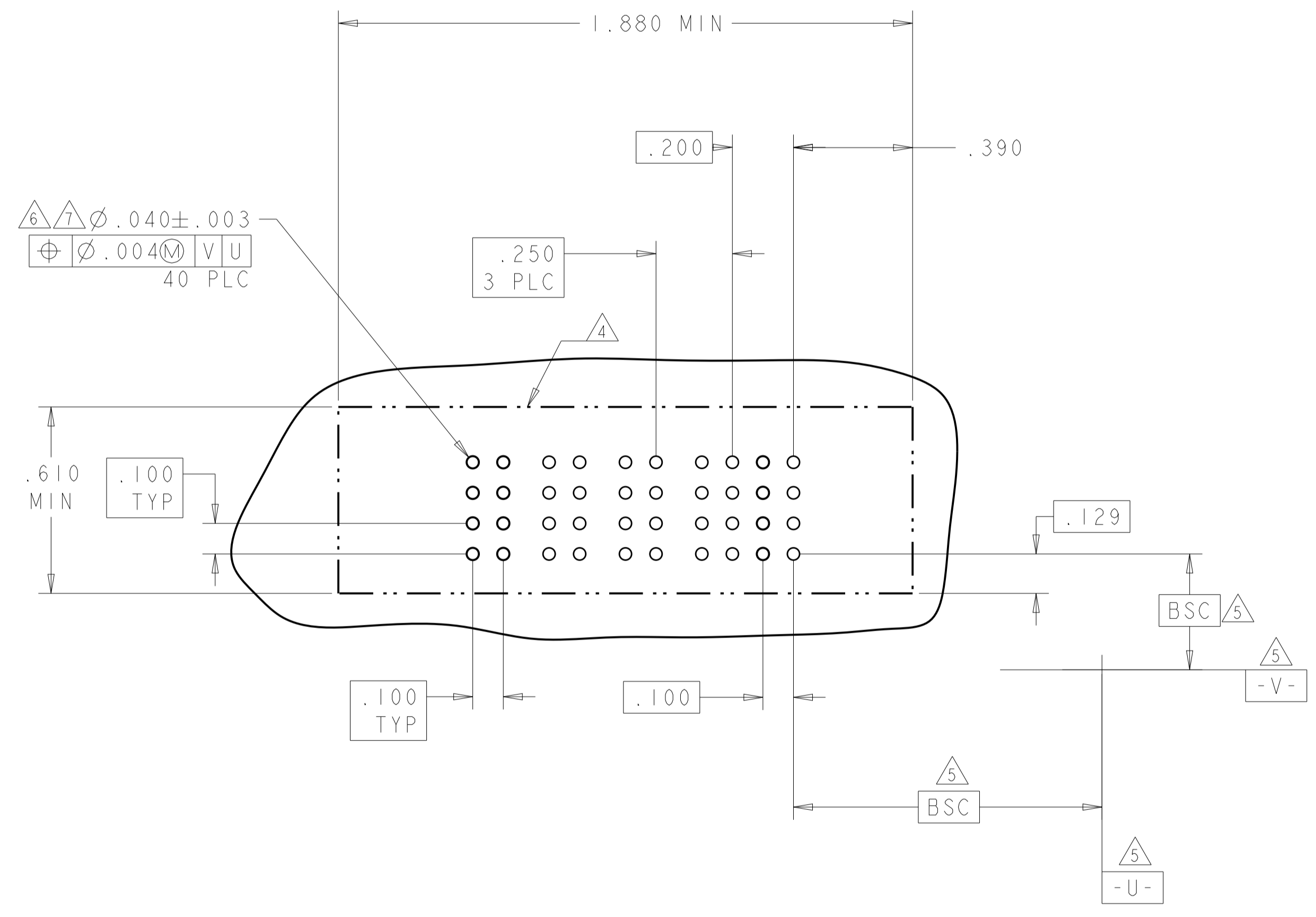

THIS DRAWING IS A CONTROLLED DOCUMENT.

DIMENSIONS:	TOLERANCES UNLESS OTHERWISE SPECIFIED:	OWN	R. GRZYBOWSKI	02MAY05
INCHES	0 PLC ±	CHK	M. PERCHERKE	02MAY05
	1 PLC ±.01	APVD	M. PERCHERKE	02MAY05
	2 PLC ±.01	NAME		
	3 PLC ±.005	VERTICAL RECEPTACLE WITH GUIDES		
	4 PLC ±.0020	MULTI-BEAM XL		
	ANGLES ±.020	SIZE CAGE CODE DRAWING NO		
MATERIAL	FINISH	A100779C=6450541		
		RESTRICTED TO		
		CUSTOMER DRAWING		
		SCALE	4:1	SHEET 10 OF 12
		REV E.4		

4805 (3/11)

LOC	DIST	REVISIONS			
P	LTN	DESCRIPTION	DATE	DMN	APVD
GP	00	SEE SHEET 1			

ASSY PART NUMBER	ROWS	SIGNAL															
		16	15	14	13	12	11	10	9	8	7	6	5	4	3	2	1
2-6450541-5	D C B A	AP	AP	AP	AP	AP	AP	AP	AP	AP	AP	AP	AP	AP	AP	AP	AP
		AP	AP	AP	AP	AP	AP	AP	AP	AP	AP	AP	AP	AP	AP	AP	AP
		AP	AP	AP	AP	AP	AP	AP	AP	AP	AP	AP	AP	AP	AP	AP	AP
		AP	AP	AP	AP	AP	AP	AP	AP	AP	AP	AP	AP	AP	AP	AP	AP
64S																	

ASSY PART NUMBER	ROWS	POWER						SIGNAL					
		P6	P5	P4	P3	P2	PI	6	5	4	3	2	1
2-6450541-6	D C B A	GP	GP	GP	GP	GP	GP	AP	AP	AP	AP	AP	AP
		GP	GP	GP	GP	GP	GP	AP	AP	AP	AP	AP	AP
		GP	GP	GP	GP	GP	GP	AP	AP	AP	AP	AP	AP
24S + 6P													

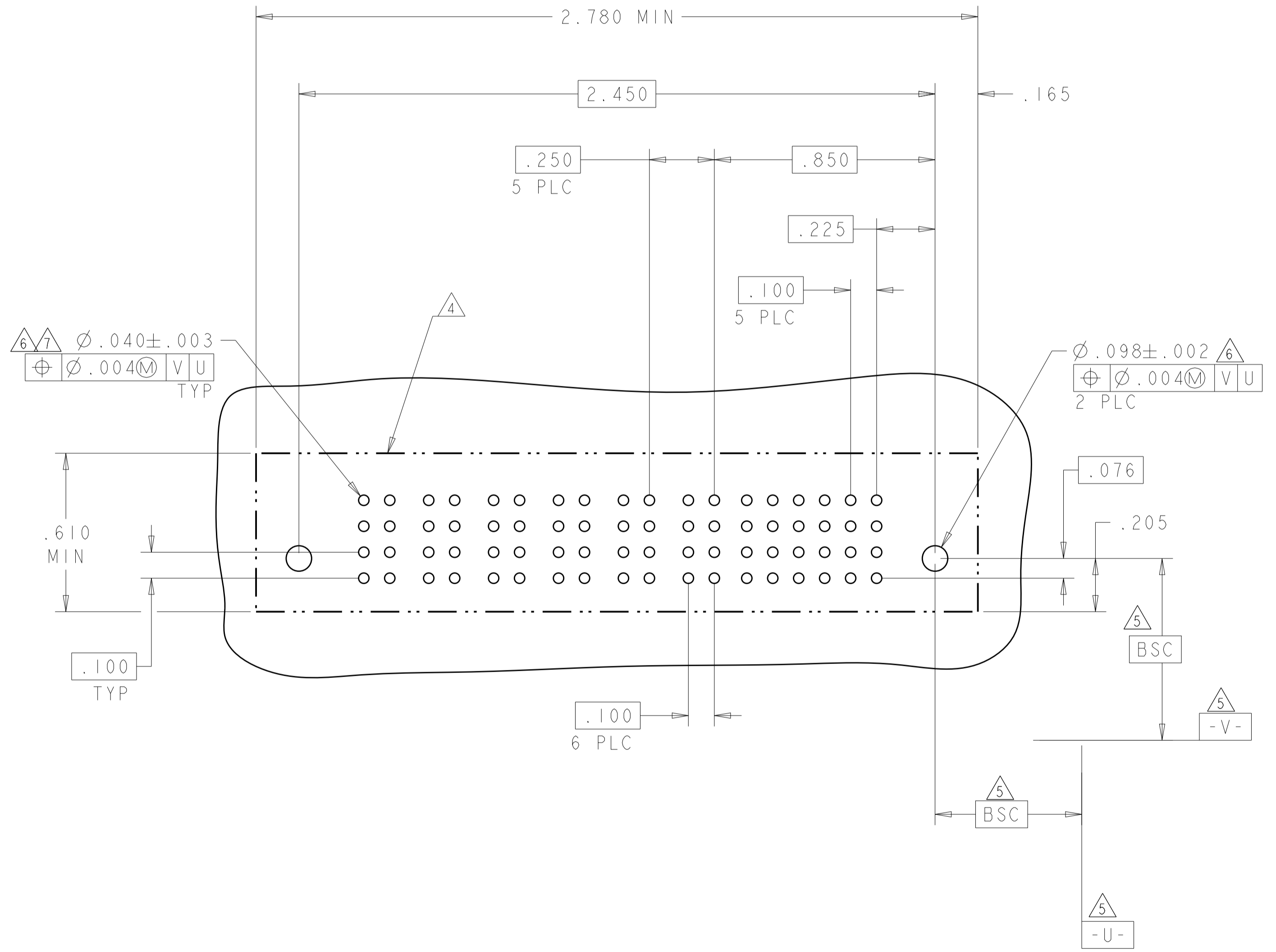
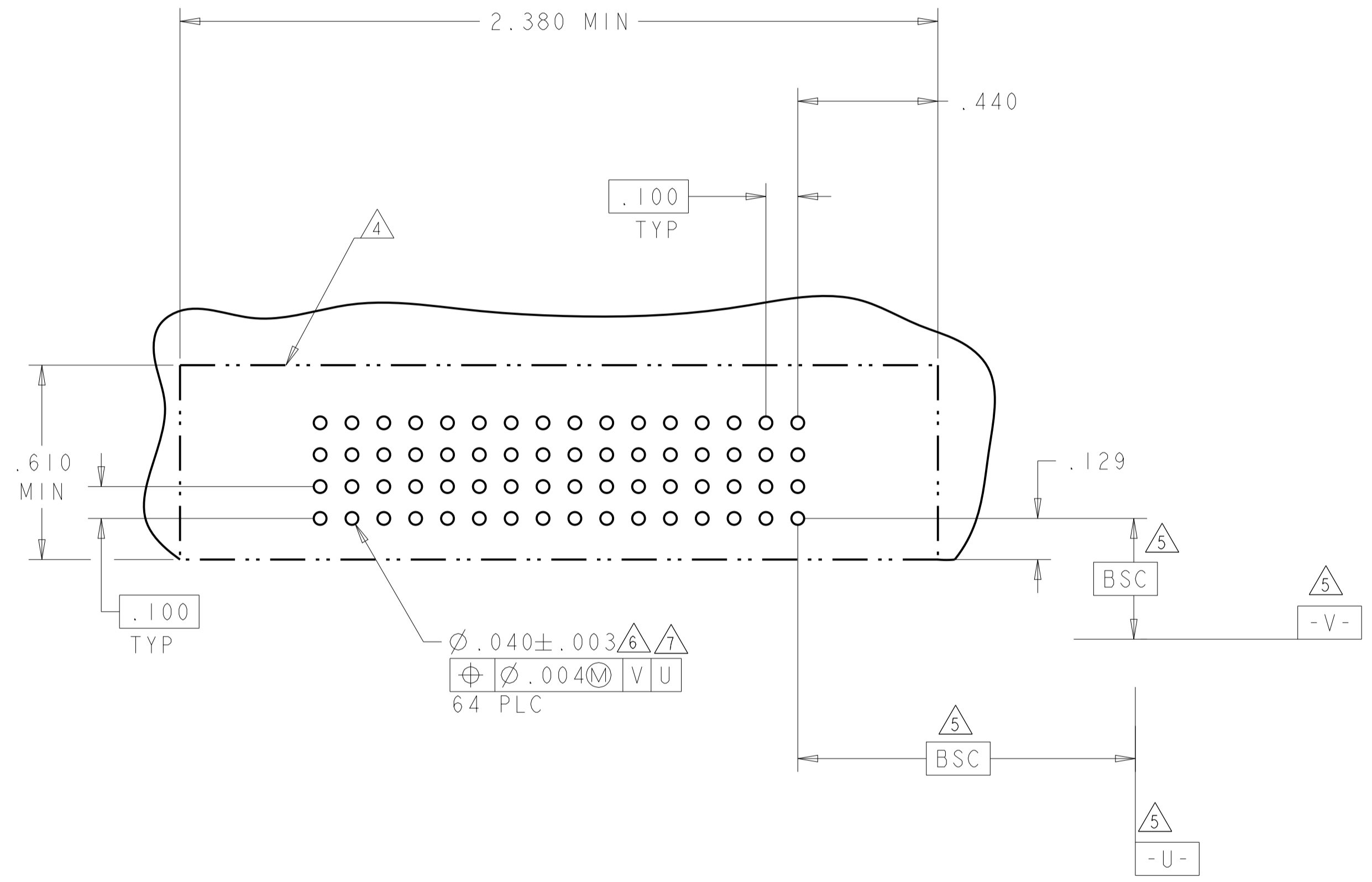

THIS DRAWING IS A CONTROLLED DOCUMENT.		DMN R. GRZYBOWSKI	02MAY05	STE TE Connectivity													
DIMENSIONS: INCHES		CHK M. PERCHERKE	02MAY05														
TOLERANCES UNLESS OTHERWISE SPECIFIED:		APVD M. PERCHERKE	02MAY05	NAME VERTICAL RECEPTACLE WITH GUIDES MULTI-BEAM XL													
<table border="0"> <tr><td>0 PLC</td><td>±</td></tr> <tr><td>1 PLC</td><td>±.01</td></tr> <tr><td>2 PLC</td><td>±.005</td></tr> <tr><td>3 PLC</td><td>±.002</td></tr> <tr><td>4 PLC</td><td>±.002</td></tr> <tr><td>ANGLES</td><td>±.020</td></tr> <tr><td>FINISH</td><td>μm</td></tr> </table>		0 PLC	±		1 PLC	±.01	2 PLC	±.005	3 PLC	±.002	4 PLC	±.002	ANGLES	±.020	FINISH	μm	PRODUCT SPEC 108-1973
0 PLC	±																
1 PLC	±.01																
2 PLC	±.005																
3 PLC	±.002																
4 PLC	±.002																
ANGLES	±.020																
FINISH	μm																
MATERIAL	FINISH	WEIGHT	SCALE	RESTRICTED TO													
			4:1														
CUSTOMER DRAWING		SIZE A	CAGE CODE 100779	DRAWING NO 6450541													
		SHEET	12	OF 12													
		REV	E	4													

Компания «Life Electronics» занимается поставками электронных компонентов импортного и отечественного производства от производителей и со складов крупных дистрибьюторов Европы, Америки и Азии.

С конца 2013 года компания активно расширяет линейку поставок компонентов по направлению коаксиальный кабель, кварцевые генераторы и конденсаторы (керамические, пленочные, электролитические), за счёт заключения дистрибьюторских договоров

Мы предлагаем:

- Конкурентоспособные цены и скидки постоянным клиентам.
- Специальные условия для постоянных клиентов.
- Подбор аналогов.
- Поставку компонентов в любых объемах, удовлетворяющих вашим потребностям.
- Приемлемые сроки поставки, возможна ускоренная поставка.
- Доставку товара в любую точку России и стран СНГ.
- Комплексную поставку.
- Работу по проектам и поставку образцов.
- Формирование склада под заказчика.
- Сертификаты соответствия на поставляемую продукцию (по желанию клиента).
- Тестирование поставляемой продукции.
- Поставку компонентов, требующих военную и космическую приемку.
- Входной контроль качества.
- Наличие сертификата ISO.

В составе нашей компании организован Конструкторский отдел, призванный помогать разработчикам, и инженерам.

Конструкторский отдел помогает осуществить:

- Регистрацию проекта у производителя компонентов.
- Техническую поддержку проекта.
- Защиту от снятия компонента с производства.
- Оценку стоимости проекта по компонентам.
- Изготовление тестовой платы монтаж и пусконаладочные работы.



Тел: +7 (812) 336 43 04 (многоканальный)

Email: org@lifeelectronics.ru