

Accessories

Couplings

Coupling Materials and Characteristics

OMRON provides two types of couplings for different application conditions: Resin and metal. Select the best type for the application.

As a general rule, use metal couplings for high resolution and resin couplings for low resolution. (As a rough guide, a high resolution is one that exceeds 3,600 ppr.)
 Even for applications requiring relatively low resolution, a metal coupling will provide more reliability in applications involving rapid acceleration/deceleration or for Encoders with high starting torque.

Comparison of Specifications for 6-mm Shafts

| Machine specification | Material Resin (standard type) | Metal (aluminum, helical) |
|--|--------------------------------------|------------------------------|
| Eccentricity (mm) | 0.5 | 0.15 |
| Eccentricity (degrees) | 6 | 3 |
| Deviation in shaft direction (mm) | ±0.4 | ±0.15 |
| Allowable torque (N-m) | 0.8 | 1.6 |
| Torsion rigidity (Nm/rad) | 7 | 28 |
| Moment of inertia (kg-m ²) | 1.2 × 10 ⁻⁷ | 6 × 10 ⁻⁷ |
| Weight (g) | 4 | 12 |

Characteristics

| Material | Advantages | Disadvantages |
|--------------------------------------|--|--|
| Resin (standard type) | <ul style="list-style-type: none"> Low cost. Easy shaft alignment when mounting. Lightweight and low moment of inertia, placing a smaller load on the drive system. | <ul style="list-style-type: none"> Low torsion rigidity and thus not suitable for high resolution. Mounting is possible even if the shafts are greatly misaligned, which can cause damage from fatigue over long periods of application. |
| Metal (aluminum, helical) | <ul style="list-style-type: none"> High torsion rigidity and thus suitable for high resolution. Transmitted allowable torque is large. | <ul style="list-style-type: none"> High cost. Heavy and thus place a large load on the drive system. The allowable shaft misalignment is small, so accurate positioning is required when mounting. |

Coupling Suitability Table

○ : Suitable and provided with product, Δ: Suitable and sold separately, ---: Not suitable.

| Couplings | Specification Shaft interior (tolerance *) exterior dia. Model | Resin, standard type | | | | | Resin, different end diameter | | Metal | |
|---|--|--|-----------------------------|---|-----------------------------|------------------------------|--------------------------------------|---------------------------------------|-------------------------------|--------------------------------|
| | | 2 dia. (Height: 8), 9 dia. | 4 dia. (Height: 8), 13 dia. | 6 dia. (Height: 8), 15 dia. | 8 dia. (Height: 8), 19 dia. | 10 dia. (Height: 8), 22 dia. | 6 dia., 8 dia., (Height: 8), 19 dia. | 6 dia., 10 dia., (Height: 8), 22 dia. | 6 dia. (Height: 8), 19.1 dia. | 10 dia. (Height: 8), 25.4 dia. |
| Rotary Encoder Model/shaft dia. | Model | E69-C02B | E69-C04B | E69-C06B | E69-C08B | E69-C10B | E69-C68B | E69-C610B | E69-C06M | E69-C10M |
| E6A2-C 4 dia. | | --- | ○ | --- | --- | --- | --- | --- | --- | --- |
| E6B2-C 6 dia. | | --- | --- | ○ | --- | --- | Δ | Δ | Δ | --- |
| E6C2-C 6 dia. | | --- | --- | Δ | --- | --- | Δ | Δ | Δ | --- |
| E6C3-C 8 dia. | | --- | --- | --- | Δ | --- | Δ | --- | --- | --- |
| E6D-C 6 dia. | | --- | --- | ○ | --- | --- | Δ | Δ | Δ | --- |
| E6F-C 10 dia. | | --- | --- | --- | --- | Δ | --- | Δ | --- | Δ |
| E6H-C Hollow shaft interior dia.: 8 mm | | Hollow-shaft Model; Coupling not required. | | | | | | | | |
| E6J-C 2 dia. | | ○ | --- | --- | --- | --- | --- | --- | --- | --- |
| E6C-N 6 dia. | | --- | --- | Δ | --- | --- | Δ | Δ | Δ | --- |
| E6CP-A 6 dia. | | --- | --- | ○ Sold separately only for E6CP-AG5C-C. | --- | --- | Δ | Δ | Δ | --- |
| E6C3-A 8 dia. | | --- | --- | --- | Δ | --- | Δ | --- | --- | --- |
| E6F-A 10 dia. | | --- | --- | --- | --- | ○ Only Pre-wired Models | --- | Δ | --- | Δ |
| E6J-A 4 dia. | | --- | ○ | --- | --- | --- | --- | --- | --- | --- |

*Tolerance conforms to JIS standard: JIS B 0401. →Refer to page 2.

(Unit: mm)

Coupling Dimensions

Tolerance class IT16 applies to dimensions in this datasheet unless otherwise specified.

E69-C02B



Material: Glass-reinforced PBT

Applicable model: E6J-C

E69-C04B



Material: Glass-reinforced PBT

Applicable model: E6A2-C, E6J-A

E69-C06B



Material: Glass-reinforced PBT

E69-C06M

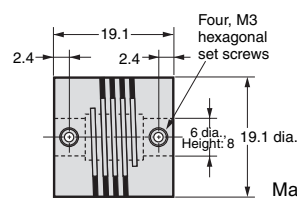

Material: Extra-super duralumin

Applicable model: E6B2-C, E6C2-C, E6D-C, E6C-N, E6CP-A

E69-C10B

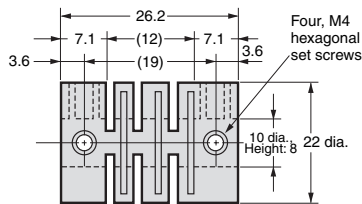

Material: Glass-reinforced PBT

E69-C10M

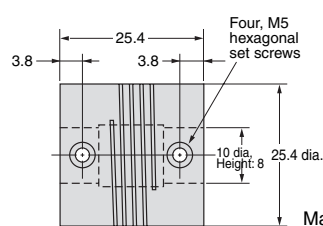

Material: Extra-super duralumin

Applicable model: E6F-C, E6F-A

E69-C08B

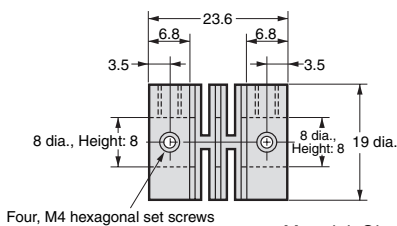

Material: Glass-reinforced PBT

Applicable model: E6C3-A, E6C3-C

E69-C68B

Model with Different End Diameter



Material: Glass-reinforced PBT

Applicable model: E6B2-C, E6C2-C, E6C3-C, E6D-C, E6C-N, E6CP-A, E6C3-A

E69-C610B

Model with Different End Diameter



Material: Glass-reinforced PBT

Applicable model: E6B2-C, E6C2-C, E6D-C, E6F-C, E6C-N, E6CP-A, E6F-A

| Standard hole dimensions (mm) | | Tolerance (μm) |
|-------------------------------|------|----------------|
| Min. | Max. | Height: 8 |
| --- | 3 | +14 0 |
| 3 | 6 | +18 0 |
| 6 | 10 | +22 0 |

Flanges and Servo Mounting Brackets

Flange and Servo Mounting Bracket Suitability Table

○: Suitable and provided with product, Δ: Suitable and sold separately, ---: Not suitable.

| Rotary Encoder Model | Type Model Remarks | Flange | | | | | Servo Mounting Bracket | | | |
|----------------------|-----------------------|--|---------|-----------|-----------|-----------|------------------------|-------------------------------|-------|--|
| | | E69-FBA | E69-FCA | E69-FCA03 | E69-FBA02 | E69-FCA02 | E69-FCA04 | E69-1 | E69-2 | |
| E6A2-C | | --- | --- | --- | --- | --- | --- | ○ Provided with the E6A2-CWZ. | --- | |
| E6B2-C | | Δ | --- | --- | Δ | --- | --- | --- | Δ | |
| E6C2-C | | --- | Δ | --- | --- | Δ | --- | --- | Δ | |
| E6C3-C | | --- | --- | Δ | --- | --- | --- | --- | Δ | |
| E6D-C | | --- | --- | --- | --- | --- | --- | --- | ○ | |
| E6F-C | | --- | --- | --- | --- | --- | --- | --- | Δ | |
| E6H-C | | Hollow-shaft Model; Flange not required. | | | | | | | | |
| E6C-N | | --- | Δ | --- | --- | Δ | --- | --- | Δ | |
| E6CP-A | | --- | --- | --- | --- | --- | --- | --- | ○ | |
| E6C3-A | | --- | --- | Δ | --- | --- | --- | --- | Δ | |
| E6F-A | | --- | --- | --- | --- | --- | --- | --- | ○ | |

Flange Dimensions

(Unit: mm)

Tolerance class IT16 applies to dimensions in this datasheet unless otherwise specified.

E69-FBA

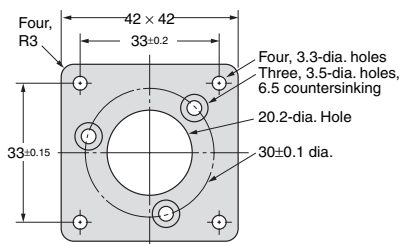

Material: SPCC
Thickness: 3.2

Applicable model: E6B2-C

Note: Three phillips screws M3 × 6 provided

E69-FCA

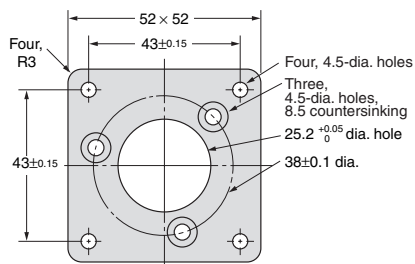

Material: SPCC
Thickness: 3.2

Applicable model: E6C2-C, E6C-N

Note: Three phillips screws M4 × 8 provided

E69-FCA03

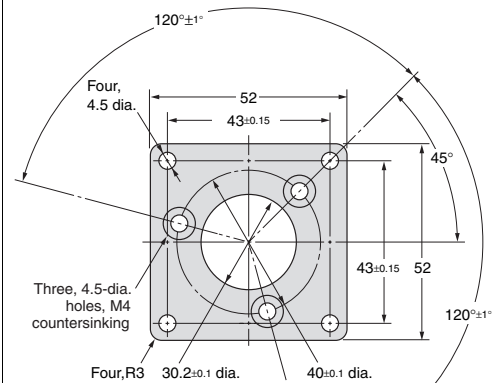

Material: SPCC
Thickness: 3.2

Applicable model: E6C3-A, E6C3-C

Note: Three phillips screws M4 × 8 provided

E69-FBA02

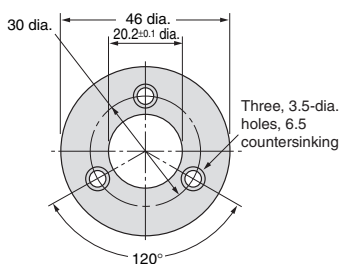

Material: SPCC
Thickness: 3.2

Applicable model: E6B2-C

Note: Three phillips screws M3 × 10 provided, E69-2 Servo Mounting Bracket provided

Mounting Diagram For the E6B2-C

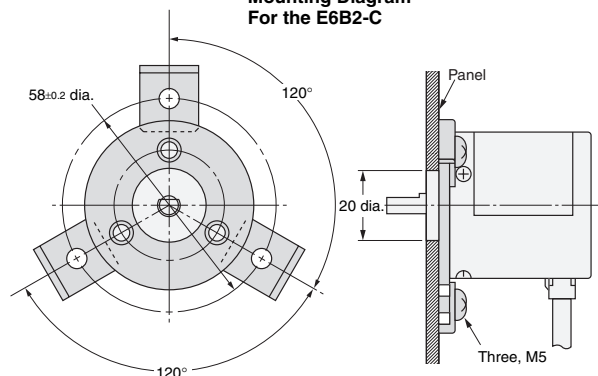

E69-FCA02



E69-FCA04



Servo Mounting Bracket Dimensions

(Unit: mm)

Tolerance class IT16 applies to dimensions in this datasheet unless otherwise specified.

E69-1 (Three brackets in a set.)



E69-2 (Three brackets in a set.)

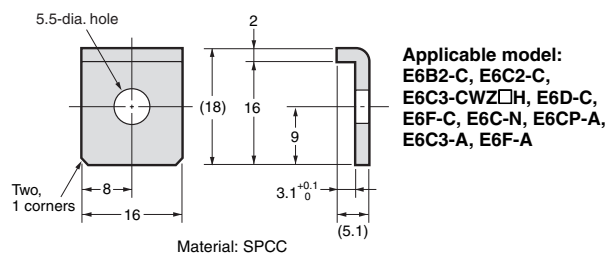

Read and Understand This Catalog

Please read and understand this catalog before purchasing the products. Please consult your OMRON representative if you have any questions or comments.

Warranty and Limitations of Liability

WARRANTY

OMRON's exclusive warranty is that the products are free from defects in materials and workmanship for a period of one year (or other period if specified) from date of sale by OMRON.

OMRON MAKES NO WARRANTY OR REPRESENTATION, EXPRESS OR IMPLIED, REGARDING NON-INFRINGEMENT, MERCHANTABILITY, OR FITNESS FOR PARTICULAR PURPOSE OF THE PRODUCTS. ANY BUYER OR USER ACKNOWLEDGES THAT THE BUYER OR USER ALONE HAS DETERMINED THAT THE PRODUCTS WILL SUITABLY MEET THE REQUIREMENTS OF THEIR INTENDED USE. OMRON DISCLAIMS ALL OTHER WARRANTIES, EXPRESS OR IMPLIED.

LIMITATIONS OF LIABILITY

OMRON SHALL NOT BE RESPONSIBLE FOR SPECIAL, INDIRECT, OR CONSEQUENTIAL DAMAGES, LOSS OF PROFITS OR COMMERCIAL LOSS IN ANY WAY CONNECTED WITH THE PRODUCTS, WHETHER SUCH CLAIM IS BASED ON CONTRACT, WARRANTY, NEGLIGENCE, OR STRICT LIABILITY.

In no event shall the responsibility of OMRON for any act exceed the individual price of the product on which liability is asserted.

IN NO EVENT SHALL OMRON BE RESPONSIBLE FOR WARRANTY, REPAIR, OR OTHER CLAIMS REGARDING THE PRODUCTS UNLESS OMRON'S ANALYSIS CONFIRMS THAT THE PRODUCTS WERE PROPERLY HANDLED, STORED, INSTALLED, AND MAINTAINED AND NOT SUBJECT TO CONTAMINATION, ABUSE, MISUSE, OR INAPPROPRIATE MODIFICATION OR REPAIR.

Application Considerations

SUITABILITY FOR USE

OMRON shall not be responsible for conformity with any standards, codes, or regulations that apply to the combination of products in the customer's application or use of the products.

At the customer's request, OMRON will provide applicable third party certification documents identifying ratings and limitations of use that apply to the products. This information by itself is not sufficient for a complete determination of the suitability of the products in combination with the end product, machine, system, or other application or use.

The following are some examples of applications for which particular attention must be given. This is not intended to be an exhaustive list of all possible uses of the products, nor is it intended to imply that the uses listed may be suitable for the products:

- Outdoor use, uses involving potential chemical contamination or electrical interference, or conditions or uses not described in this catalog.
- Nuclear energy control systems, combustion systems, railroad systems, aviation systems, medical equipment, amusement machines, vehicles, safety equipment, and installations subject to separate industry or government regulations.
- Systems, machines, and equipment that could present a risk to life or property.

Please know and observe all prohibitions of use applicable to the products.

NEVER USE THE PRODUCTS FOR AN APPLICATION INVOLVING SERIOUS RISK TO LIFE OR PROPERTY WITHOUT ENSURING THAT THE SYSTEM AS A WHOLE HAS BEEN DESIGNED TO ADDRESS THE RISKS, AND THAT THE OMRON PRODUCTS ARE PROPERLY RATED AND INSTALLED FOR THE INTENDED USE WITHIN THE OVERALL EQUIPMENT OR SYSTEM.

PROGRAMMABLE PRODUCTS

OMRON shall not be responsible for the user's programming of a programmable product, or any consequence thereof.

Disclaimers

CHANGE IN SPECIFICATIONS

Product specifications and accessories may be changed at any time based on improvements and other reasons.

It is our practice to change model numbers when published ratings or features are changed, or when significant construction changes are made. However, some specifications of the products may be changed without any notice. When in doubt, special model numbers may be assigned to fix or establish key specifications for your application on your request. Please consult with your OMRON representative at any time to confirm actual specifications of purchased products.

DIMENSIONS AND WEIGHTS

Dimensions and weights are nominal and are not to be used for manufacturing purposes, even when tolerances are shown.

PERFORMANCE DATA

Performance data given in this catalog is provided as a guide for the user in determining suitability and does not constitute a warranty. It may represent the result of OMRON's test conditions, and the users must correlate it to actual application requirements. Actual performance is subject to the OMRON Warranty and Limitations of Liability.

ERRORS AND OMISSIONS

The information in this document has been carefully checked and is believed to be accurate; however, no responsibility is assumed for clerical, typographical, or proofreading errors, or omissions.

2010.8

In the interest of product improvement, specifications are subject to change without notice.

OMRON Corporation
Industrial Automation Company

<http://www.ia.omron.com/>

(c)Copyright OMRON Corporation 2010 All Right Reserved.

Mouser Electronics

Authorized Distributor

Click to View Pricing, Inventory, Delivery & Lifecycle Information:

Omron:

[E69-1](#) [E69-2](#) [E69-C04B](#) [E69-C06B](#) [E69-C08B](#) [E69-C10B](#) [E69-C610B](#) [E69-C68B](#) [E69-DC5](#) [E69-DF10 10M](#) [E69-DF15](#) [E69-DF2](#) [E69-DF20](#) [E69-DF25 25M](#) [E69-DF30](#) [E69-DF5 5M](#) [E69-DF98](#) [E69-FBA](#) [E69-FBA-02](#) [E69-FCA](#) [E69-FCA02](#) [E69-FCA03](#) [E69-FCA04](#)

Компания «Life Electronics» занимается поставками электронных компонентов импортного и отечественного производства от производителей и со складов крупных дистрибьюторов Европы, Америки и Азии.

С конца 2013 года компания активно расширяет линейку поставок компонентов по направлению коаксиальный кабель, кварцевые генераторы и конденсаторы (керамические, пленочные, электролитические), за счёт заключения дистрибьюторских договоров

Мы предлагаем:

- Конкурентоспособные цены и скидки постоянным клиентам.
- Специальные условия для постоянных клиентов.
- Подбор аналогов.
- Поставку компонентов в любых объемах, удовлетворяющих вашим потребностям.
- Приемлемые сроки поставки, возможна ускоренная поставка.
- Доставку товара в любую точку России и стран СНГ.
- Комплексную поставку.
- Работу по проектам и поставку образцов.
- Формирование склада под заказчика.
- Сертификаты соответствия на поставляемую продукцию (по желанию клиента).
- Тестирование поставляемой продукции.
- Поставку компонентов, требующих военную и космическую приемку.
- Входной контроль качества.
- Наличие сертификата ISO.

В составе нашей компании организован Конструкторский отдел, призванный помогать разработчикам, и инженерам.

Конструкторский отдел помогает осуществить:

- Регистрацию проекта у производителя компонентов.
- Техническую поддержку проекта.
- Защиту от снятия компонента с производства.
- Оценку стоимости проекта по компонентам.
- Изготовление тестовой платы монтаж и пусконаладочные работы.



Тел: +7 (812) 336 43 04 (многоканальный)

Email: org@lifeelectronics.ru