

LOC		DIST		REVISIONS			
P	LTN	DESCRIPTION	DATE	DWN	APVD		
E8		REV PER ECR-12-021802	04JAN2013	ML	SZ		
E9		ADD NEW DASH NUMBER 2-3	21MAY2013	CZ	SZ		

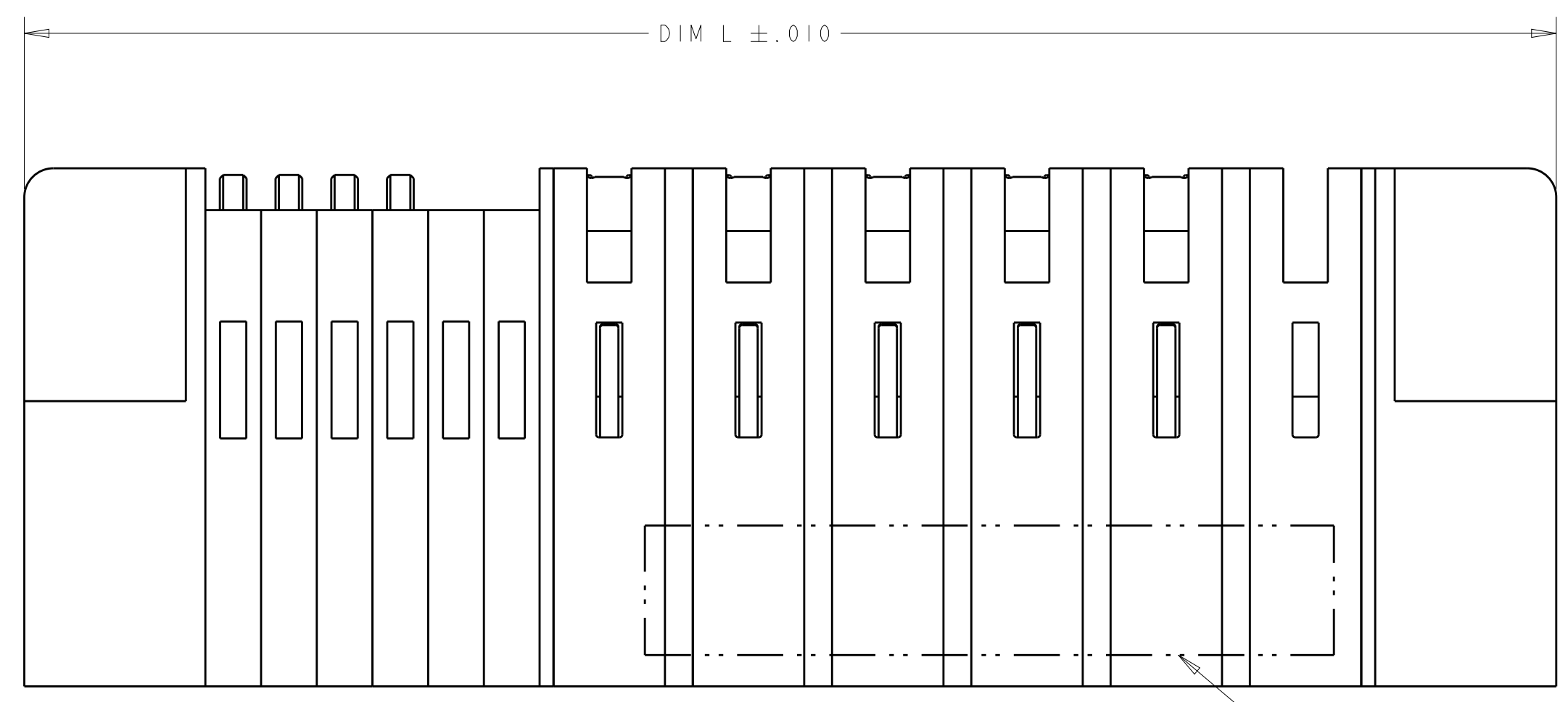

- ⚠ "AMP", PART NUMBER, AND DATE CODE TO BE MARKED IN AREA SHOWN.
- ⚠ MATERIAL: HOUSING - GLASS FILLED HIGH TEMP THERMO PLASTIC, UL94 V-0  
 SIGNAL CONTACT - COPPER ALLOY  
 POWER CONTACT - HIGH CONDUCTIVITY COPPER ALLOY
- ⚠ CONTACT PLATING: NOBLE METAL PLATING ON CONTACT FUNCTIONAL AREA OF POWER CONTACTS AND SIGNAL CONTACTS.
- ⚠ MECHANICAL CONNECTOR KEEP OUT ZONE.
- ⚠ DATUM AND BASIC DIMENSIONS ESTABLISHED BY CUSTOMER.
- ⚠ PCB - ALL HOLE DIAMETERS ARE FINISHED HOLE SIZES.
- ⚠ PCB - .0453±.0010 DRILLED HOLES PLATED WITH .0003 MIN Sn OVER .001 TO .003 CU PLATING TO ACHIEVE A .040±.003 DIA HOLE

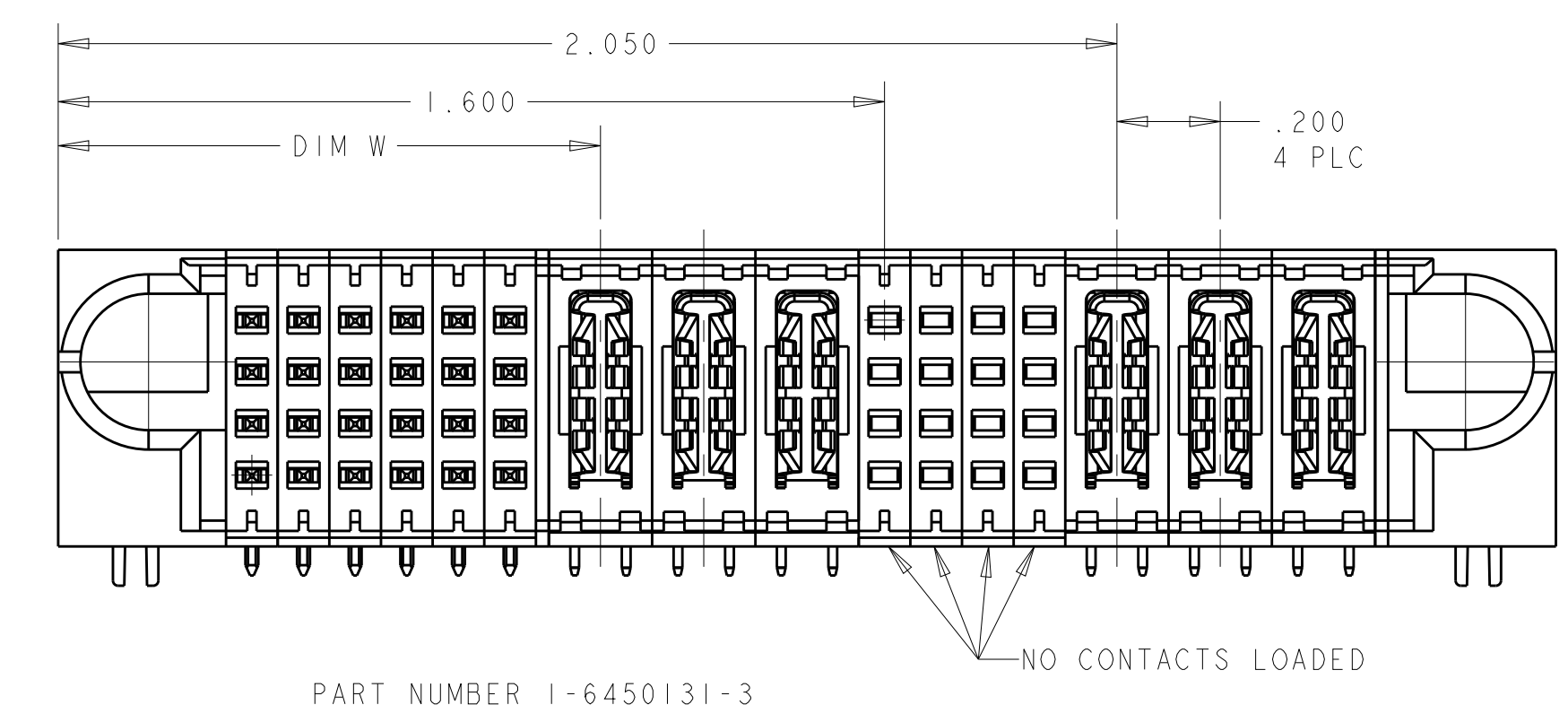
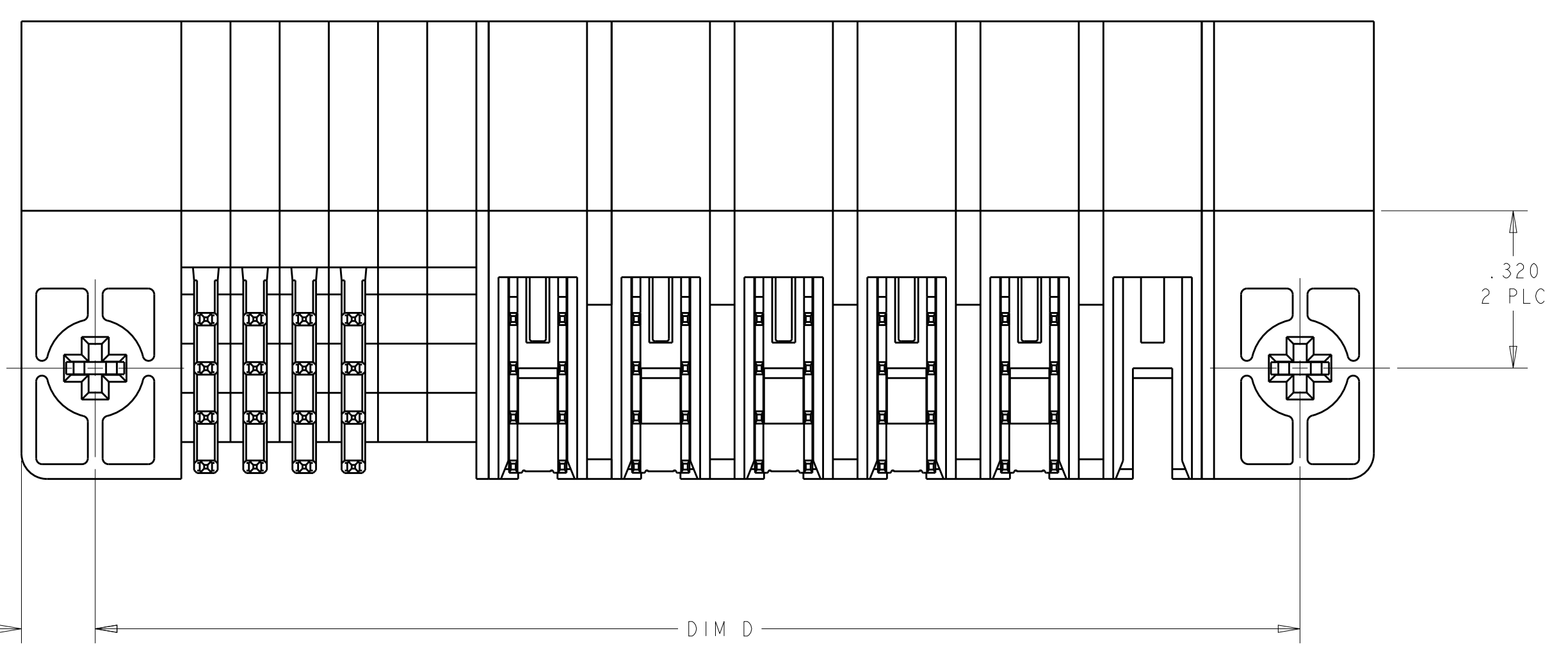
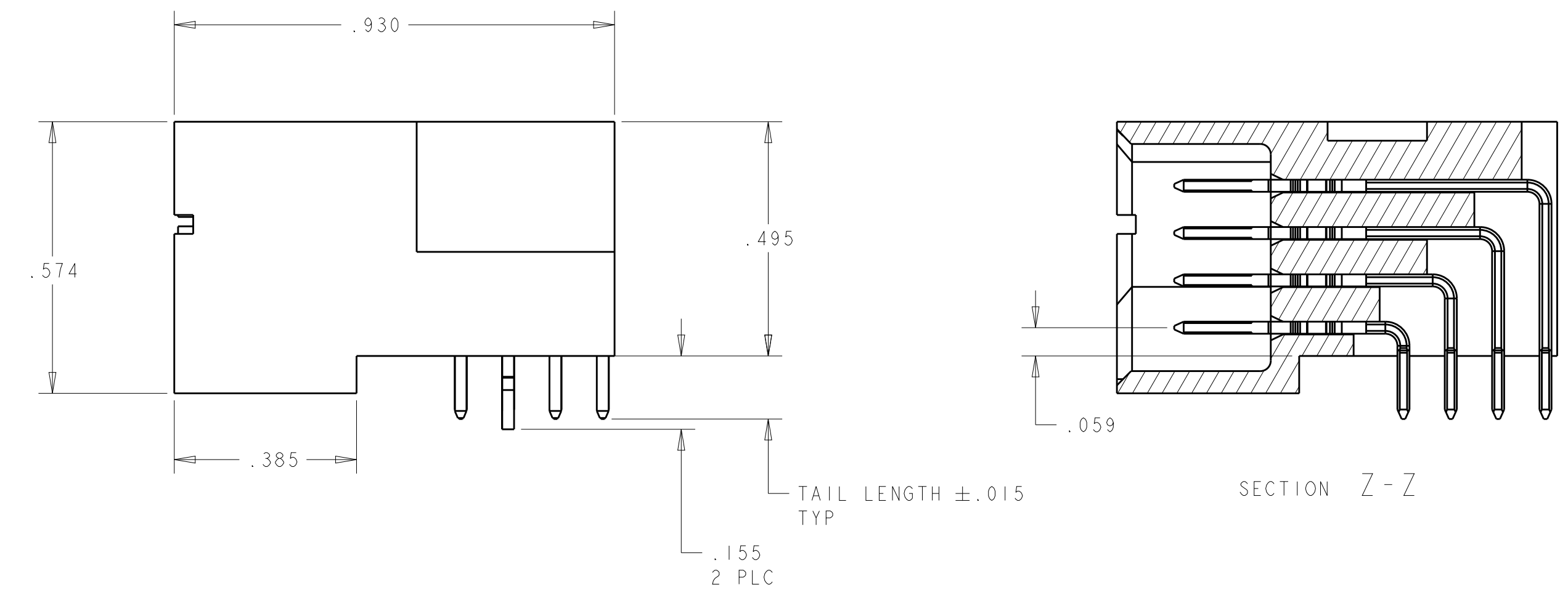
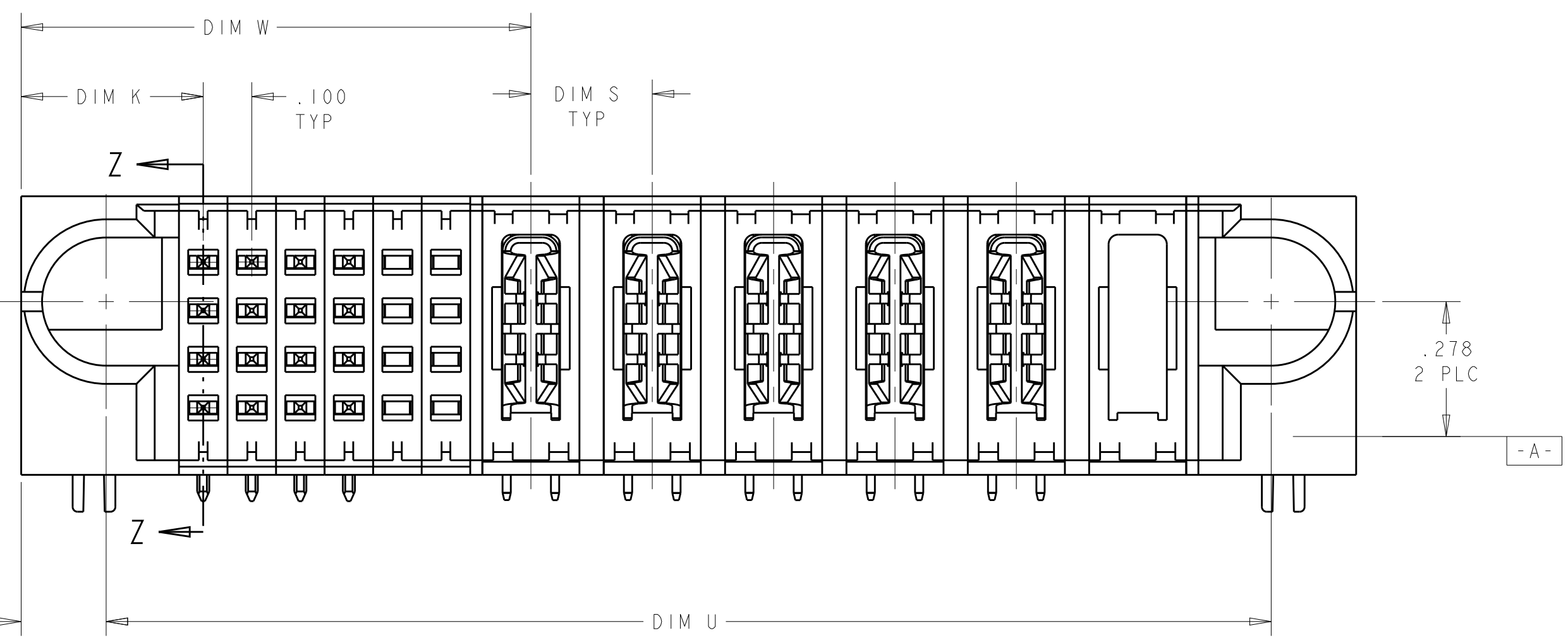

PART NUMBER 1-6450131-3

THIS DRAWING IS A CONTROLLED DOCUMENT.		DWN R. GRZYBOWSKI CHK M. PERCHERKE	15FEB05 15FEB05	TE Connectivity
DIMENSIONS: INCHES		TOLERANCES UNLESS OTHERWISE SPECIFIED: 0 PLC ±. 1 PLC ±.01 2 PLC ±.005 3 PLC ±.002 4 PLC ±.002 ANGLES ±.2° FINISH		
MATERIAL:		APVD M. PERCHERKE		RESTRICTED TO A100779C=6450131 SCALE 1:1 SHEET 1 OF 9 REV E9

LOC	DIST	REVISIONS					
		P	LTN	DESCRIPTION	DATE	DWN	APVD
ES	00	-	-	SEE SHEET 1	-	-	-

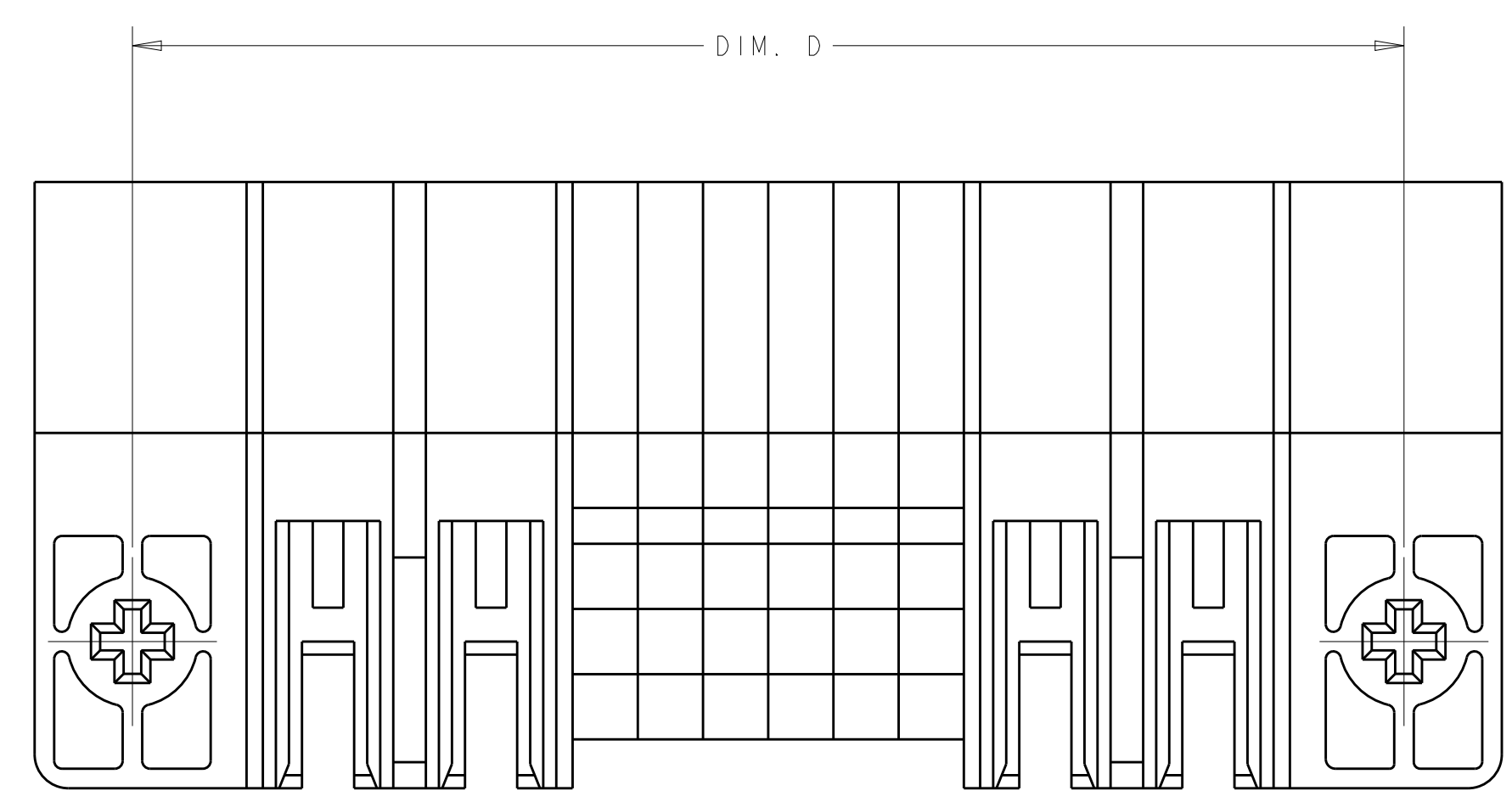
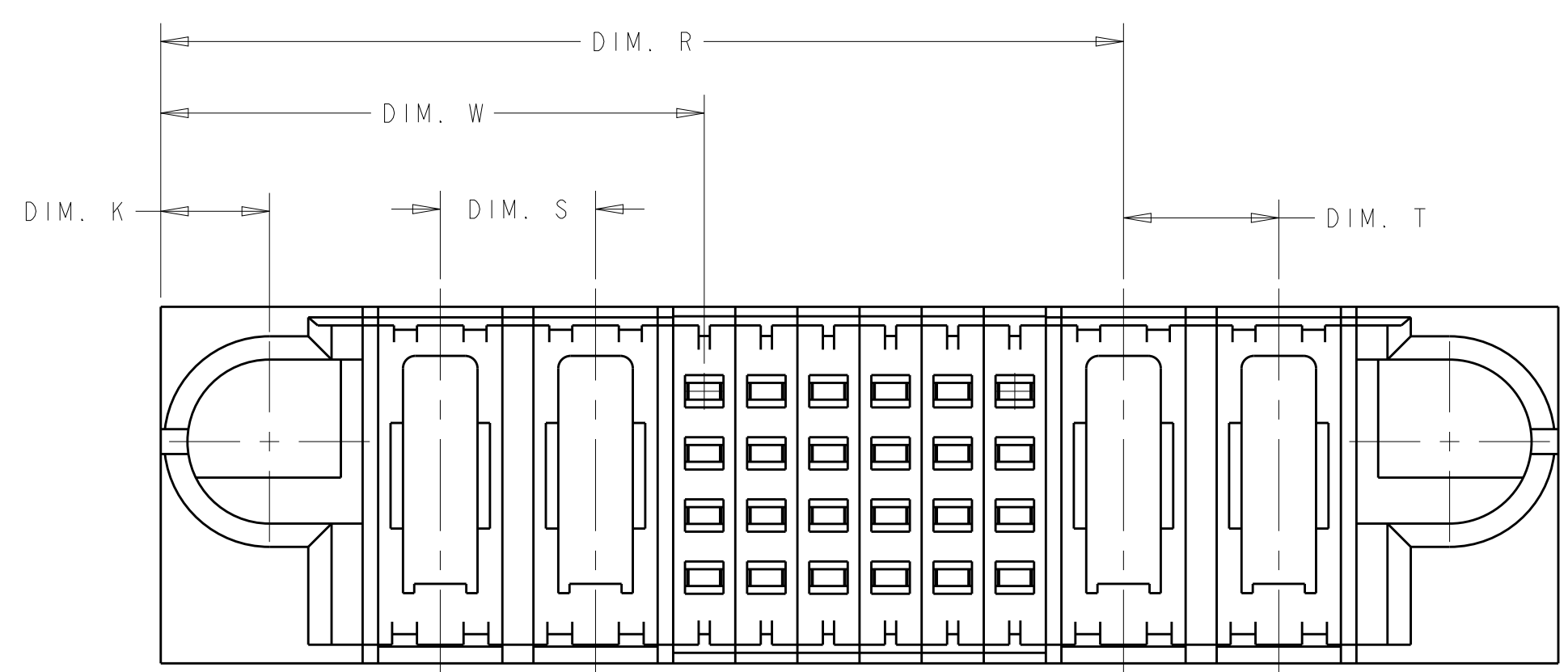
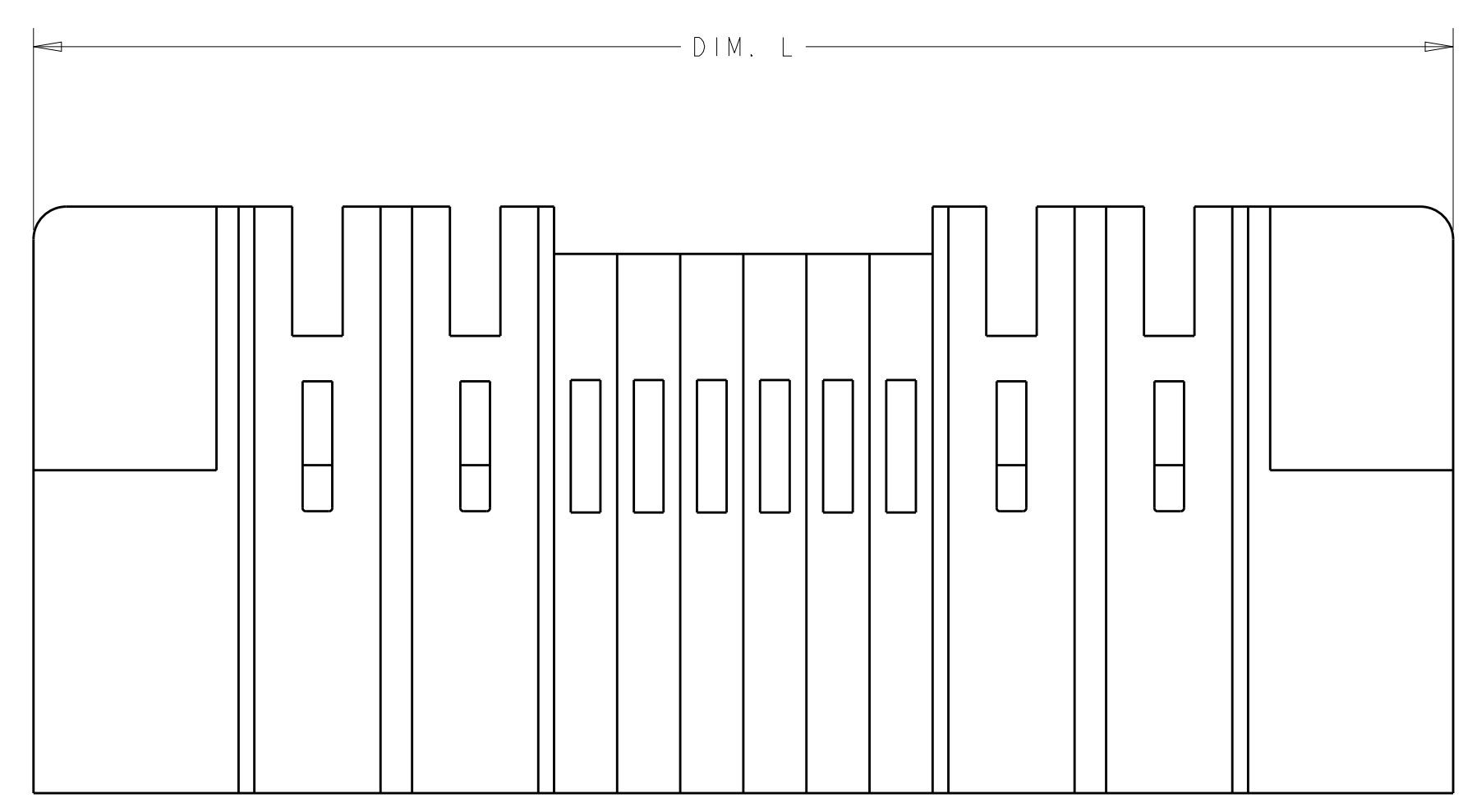

PART 2-6450131-1  
(NO CONTACT VIEW)

DIM R	DIM T	DIM U	DIM S	DIM K	DIM D	DIM W	DIM L	DESCRIPTION	PART NUMBER
-	-	4.650	.250	.400	4.700	1.800	5.000	52S + 12P	2-6450131-3
-	-	1.700	.250	.375	1.750	.850	2.050	16S + 4P	2-6450131-2
1.550	.250	1.900	.250	.450	1.950	.875	2.250	24S	2-6450131-1
		1.600	.250	.375	1.650	.750	1.950	12S + 4P	1-6450131-9
		3.650	.250	.400	3.700	1.300	4.000	32S + 10P	1-6450131-8
		2.950	.200	.375	3.000	1.050	3.300	24S + 10HDP	1-6450131-7
		2.400	.250	.375	2.450	1.050	2.750	24S + 6P	1-6450131-6
		2.450	.200	.375	2.500	.950	2.800	20S + 8P	1-6450131-5
		2.400	.250	.375	2.450	1.050	2.750	24S + 6P	1-6450131-4
		2.550	.200	.375	2.600	1.050	2.900	24S + 3P + 16S + 3P	1-6450131-3
		2.500	.250	.425	2.550	.875	2.850	12S + 7P	1-6450131-1
		2.400	.250	.375	2.450	1.050	2.750	24S + 6P	6450131-7
		2.700	.300	.375	2.750	.775	3.050	12S + 7ACP	6450131-6
		2.400	.250	.375	2.450	1.050	2.750	24S + 6P	6450131-5
		4.400	.250	.375	4.450	1.050	4.750	24S + 14P	6450131-4
		1.950	.250	.375	2.000	.850	2.300	16S + 5P	6450131-3

THIS DRAWING IS A CONTROLLED DOCUMENT. DWN: R. GRZYBOWSKI 15FEB05  
 CHK: M. PERCHERKE 15FEB05  
 APVD: M. PERCHERKE

DIMENSIONS: INCHES. TOLERANCES UNLESS OTHERWISE SPECIFIED:  
 0 PLC ±.01  
 1 PLC ±.01  
 2 PLC ±.01  
 3 PLC ±.005  
 4 PLC ±.0020  
 ANGLES ±.020

MATERIAL: . FINISH: .

TE Connectivity  
 NAME: RIGHT ANGLE HEADER ASSY  
 SOLDER CONTACTS, W/GUIDES  
 MULTI-BEAM XL  
 PRODUCT SPEC: 108-1973  
 APPLICATION SPEC: 114-13038  
 WEIGHT: .  
 CUSTOMER DRAWING

SIZE: A1 CAGE CODE: 6450131 DRAWING NO: 100779  
 SCALE: 1:1 SHEET 2 OF 9 REV: E9

LOC	DIST	REV	DATE	BY	APPD
ES	00				

REVISIONS		DATE	BY	APPD
1	SEE SHEET 1			

PART NUMBER	ROWS	SIGNAL				POWER					
		1	2	3	4	P1	P2	P3	P4	P5	
6450131-3	D	J	J	J	J	PM	PM	PM	PM	PM	
	C	K	K	K	K						
	B	N	N	N	N						
	A	S	S	S	H						
16S + 5P		HD									

PART NUMBER	ROWS	SIGNAL						POWER															
		1	2	3	4	5	6	P1	P2	P3	P4	P5	P6	P7	P8	P9	P10	P11	P12	P13	P14		
6450131-4	D	J	J	J	J	J	J	PM	PM	PM	PM	PM	PM	PM	PM	PM	PM	PM	PM	PM	PM	PM	
	C	K	K	K	K	K	K																
	B	N	N	N	N	N	N																
	A	S	S	H	H	S	S																
24S + 14P		HD																					

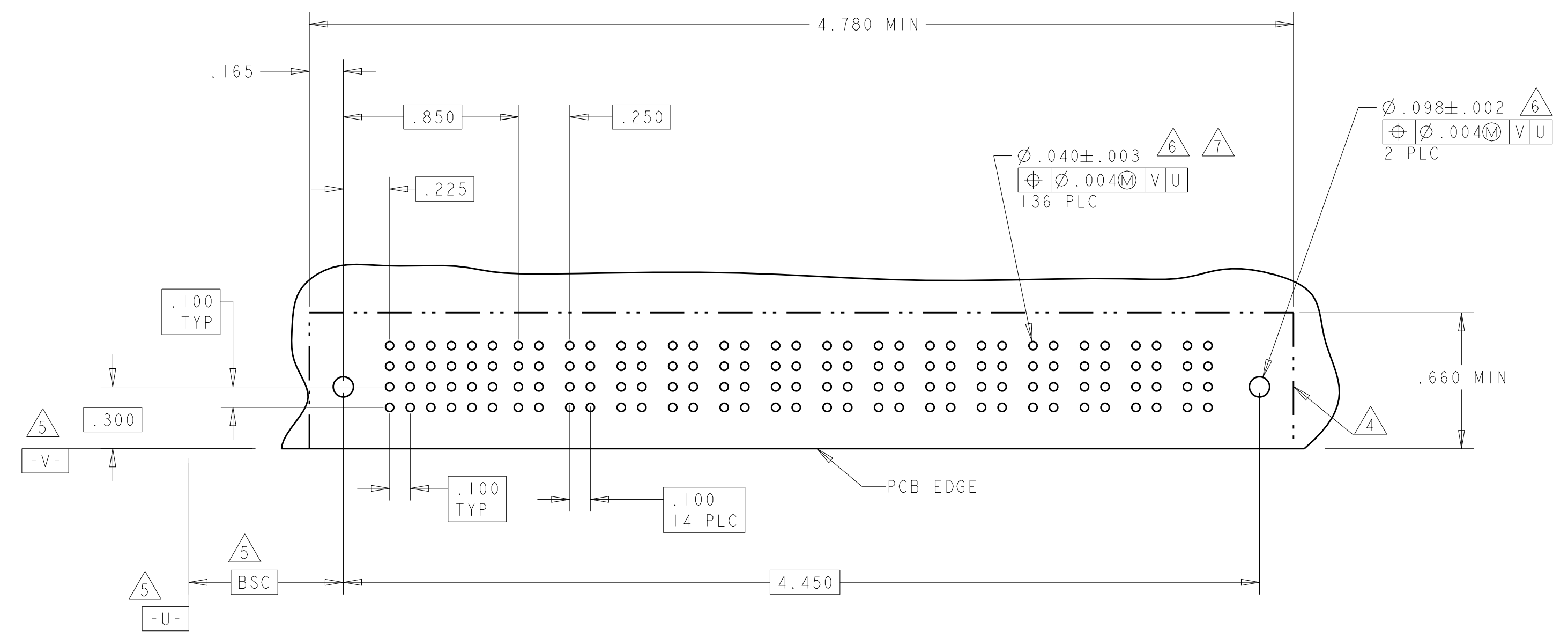
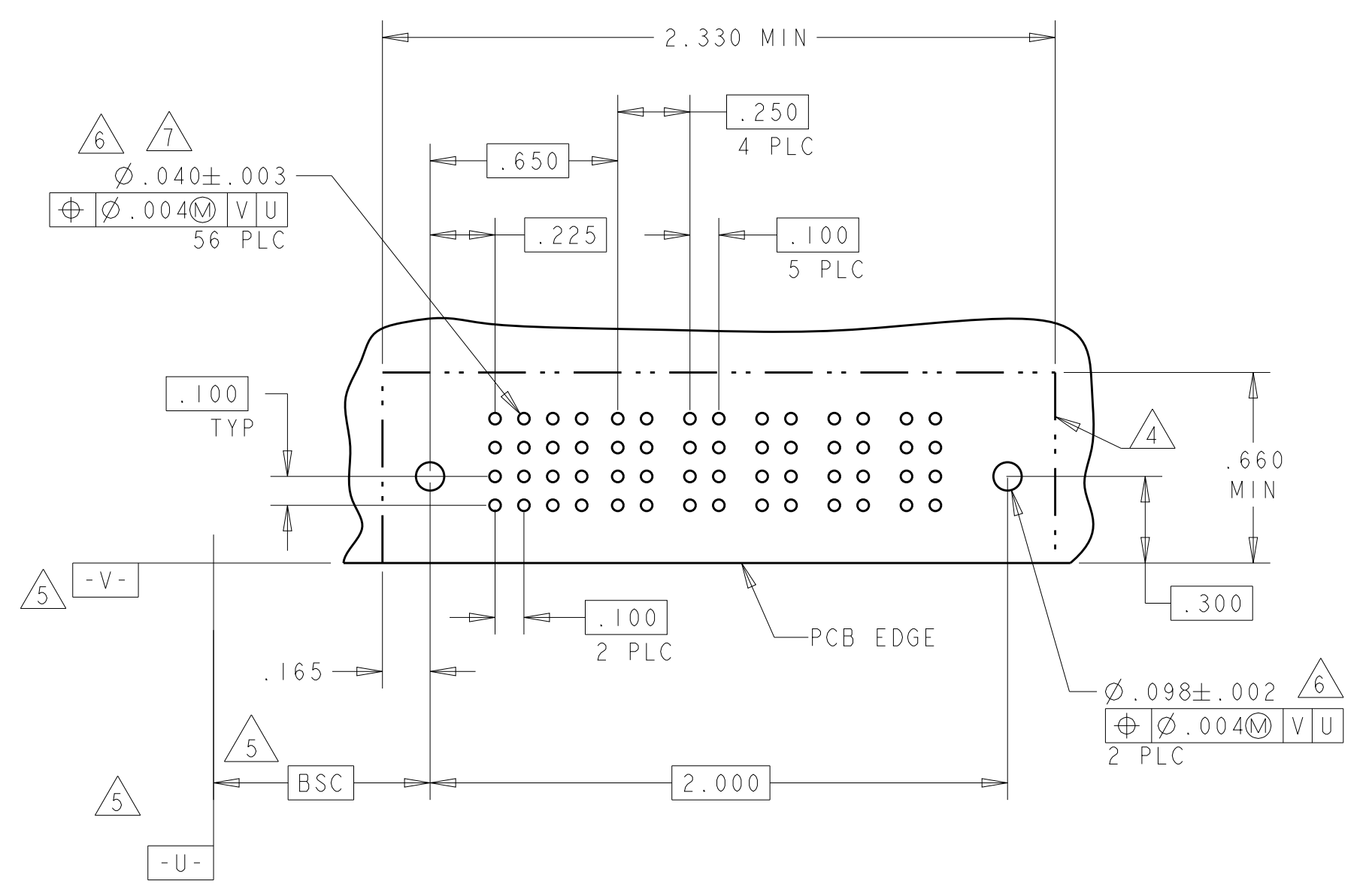

PART NUMBER	ROWS	SIGNAL						POWER					
		1	2	3	4	5	6	P1	P2	P3	P4	P5	P6
6450131-5	D	J	J	J	J	J	E	PM	PM	PM	PM	PM	PM
	C	K	K	K	K	K	K						
	B	N	N	N	N	N	N						
	A	H	S	S	S	S	S						
24S + 6P		HD											

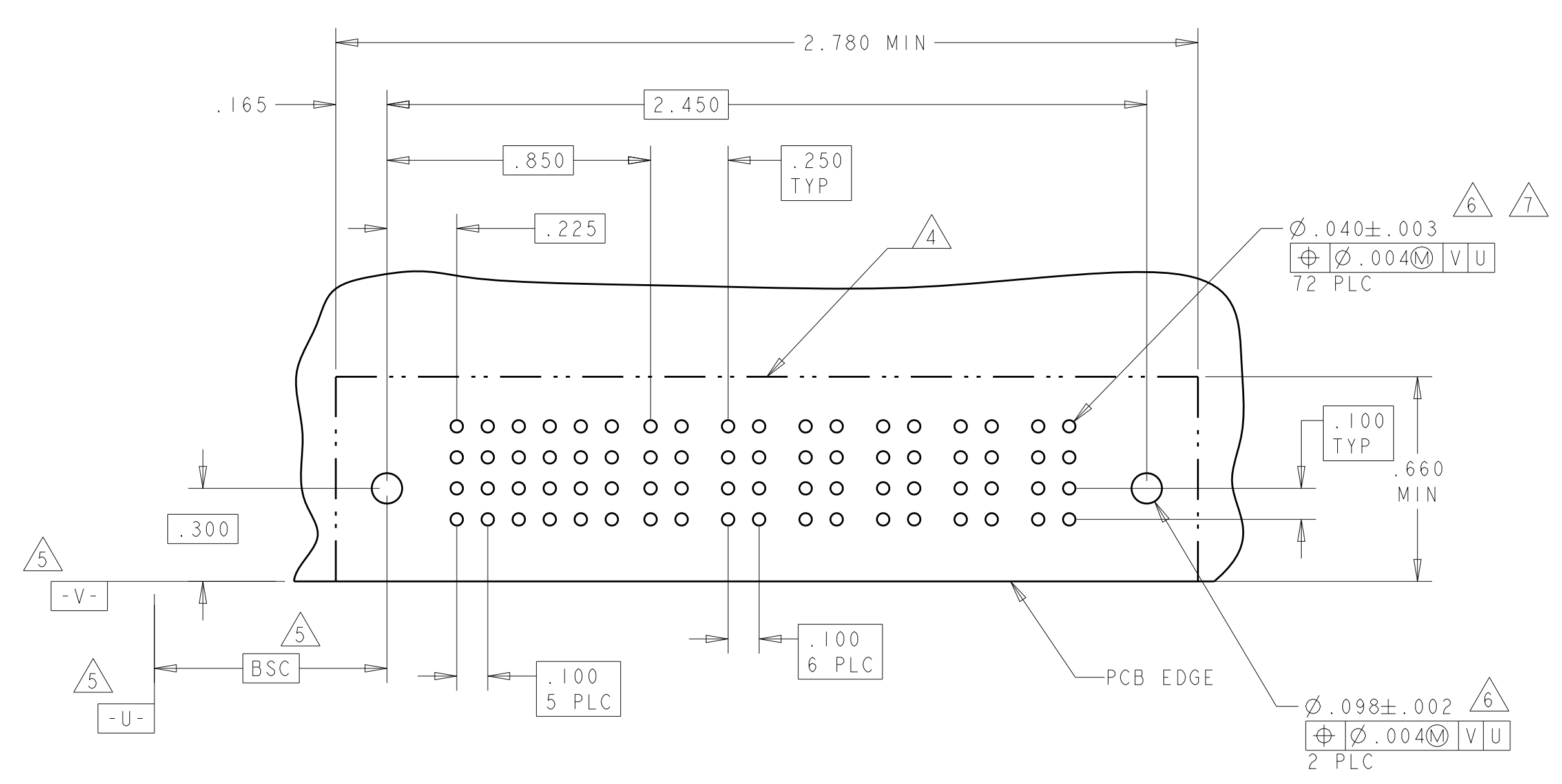

Z	STD	.090	D
Y	STD	.090	C
R	STD	.090	B
O	STD	.090	A
A4	MLBF	.090	D
A3	MLBF	.090	C
A2	MLBF	.090	B
A1	MLBF	.090	A
E	MLBF	.135	D
F	MLBF	.135	C
G	MLBF	.135	B
H	MLBF	.135	A
FJ	MFLB	.135	D
J	STD	.135	D
K	STD	.135	C
N	STD	.135	B
S	STD	.135	A

CODE	MATING SEQUENCE	TAIL LENGTH	ROW
PA		.090	
PM		.135	

CODE	MATING SEQUENCE	TAIL LENGTH	ROW
J		.135	D
K		.135	C
N		.135	B
S		.135	A

PA	.090
PM	.135
CODE	TAIL LENGTH
POWER CONTACT	

THIS DRAWING IS A CONTROLLED DOCUMENT.

DIMENSIONS: INCHES	TOLERANCES UNLESS OTHERWISE SPECIFIED:	0 PLC ± .01	1 PLC ± .01	2 PLC ± .01	3 PLC ± .01	4 PLC ± .01	5 PLC ± .01	6 PLC ± .01	7 PLC ± .01	8 PLC ± .01	9 PLC ± .01	10 PLC ± .01	11 PLC ± .01	12 PLC ± .01	13 PLC ± .01	14 PLC ± .01	15 PLC ± .01	16 PLC ± .01	17 PLC ± .01	18 PLC ± .01	19 PLC ± .01	20 PLC ± .01	21 PLC ± .01	22 PLC ± .01	23 PLC ± .01	24 PLC ± .01	25 PLC ± .01	26 PLC ± .01	27 PLC ± .01	28 PLC ± .01	29 PLC ± .01	30 PLC ± .01
--------------------	--	-------------	-------------	-------------	-------------	-------------	-------------	-------------	-------------	-------------	-------------	--------------	--------------	--------------	--------------	--------------	--------------	--------------	--------------	--------------	--------------	--------------	--------------	--------------	--------------	--------------	--------------	--------------	--------------	--------------	--------------	--------------

MATERIAL: . FINISH: . WEIGHT: .

APPROVED: M. PERCHERKE

DATE: 108-1973

APPLICATION SPEC: 114-13038

SCALE: 1:1

SHEET 3 OF 9

REV: E9

TE Connectivity

RIGHT ANGLE HEADER ASSY  
SOLDER CONTACTS, W/GUIDES  
MULTI-BEAM XL

SIZE: A1

CAGE CODE: 6450131

CUSTOMER DRAWING

PART NUMBER	ROWS	SIGNAL			POWER						
		1	2	3	P1	P2	P3	P4	P5	P6	P7
6450131-6	D C B A	Z	Z	Z	PA	PA	PA	PA	PA	PA	PA
		Y	Y	Y							
		R	R	R							
		A	O	O							

PART NUMBER	ROWS	SIGNAL			POWER						
		1	2	3	P1	P2	P3	P4	P5	P6	P7
1-6450131-1	D C B A	J	J	J	PM	PM	PM	PM	PM	PM	PM
		K	K	K							
		N	N	N							
		S	S	S							

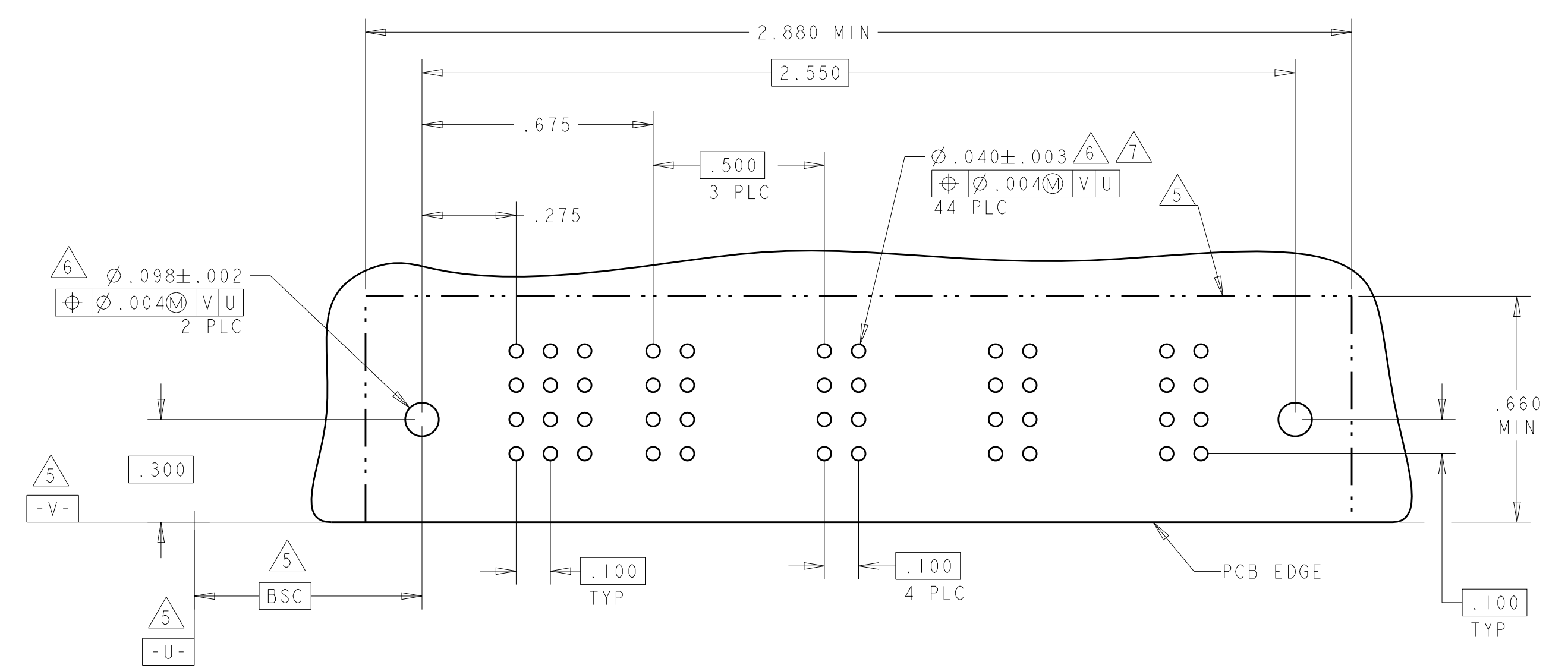
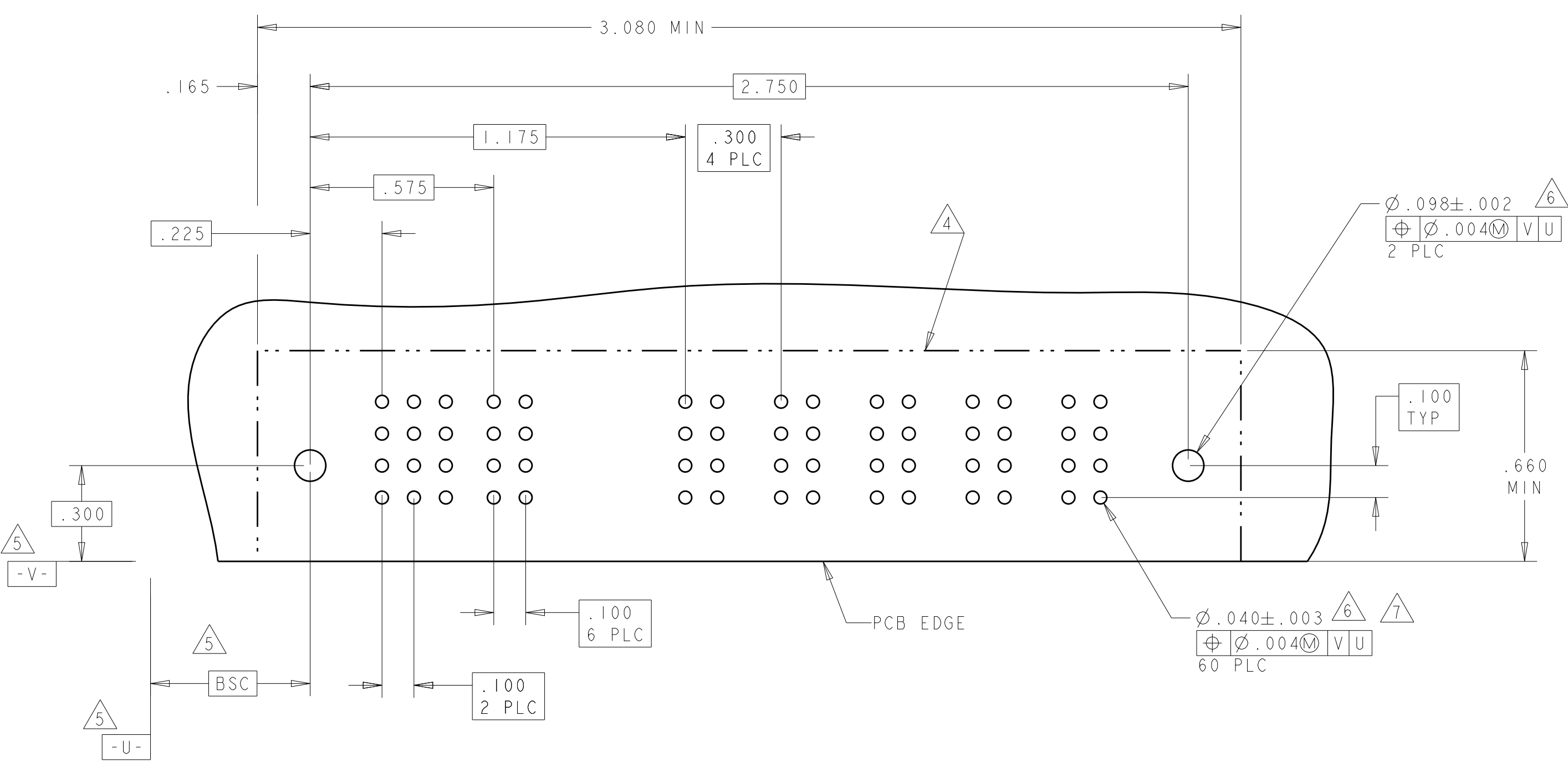

PART NUMBER	ROWS	SIGNAL						POWER					
		1	2	3	4	5	6	P1	P2	P3	P4	P5	P6
6450131-7	D C B A	E	E	J	J	J	E	PM	PM	PM	PM	PM	PM
		F	F	K	K	K	K						
		G	G	N	N	N	N						
		H	H	S	S	S	S						

PART NUMBER	ROWS	SIGNAL						POWER			SIGNAL				POWER		
		1	2	3	4	5	6	P1	P2	P3	7	8	9	10	P4	P5	P6
1-6450131-3	D C B A	J	J	J	J	J	E	PM	PM	PM	PM	PM	PM	PM	PM	PM	PM
		K	K	K	K	K	K										
		N	N	N	N	N	N										
		H	S	S	S	S	S										

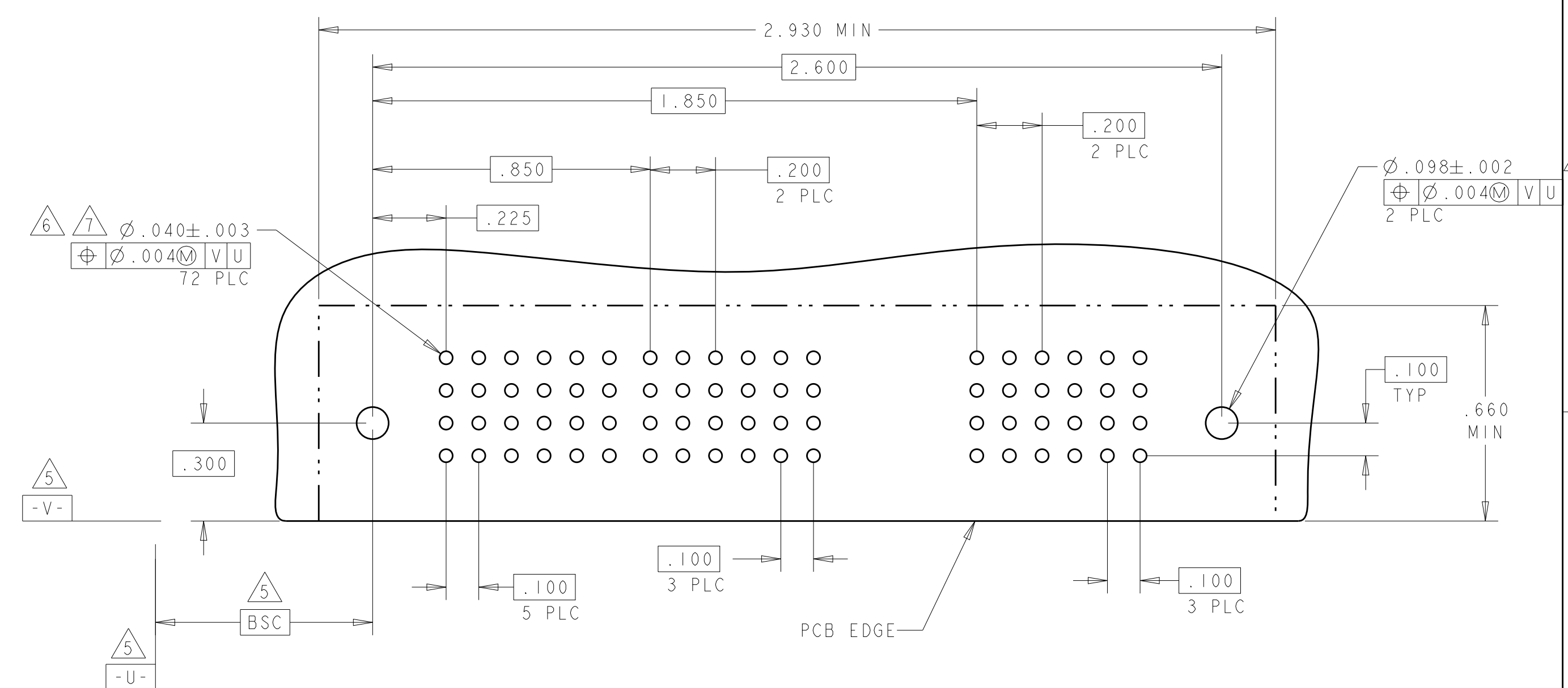
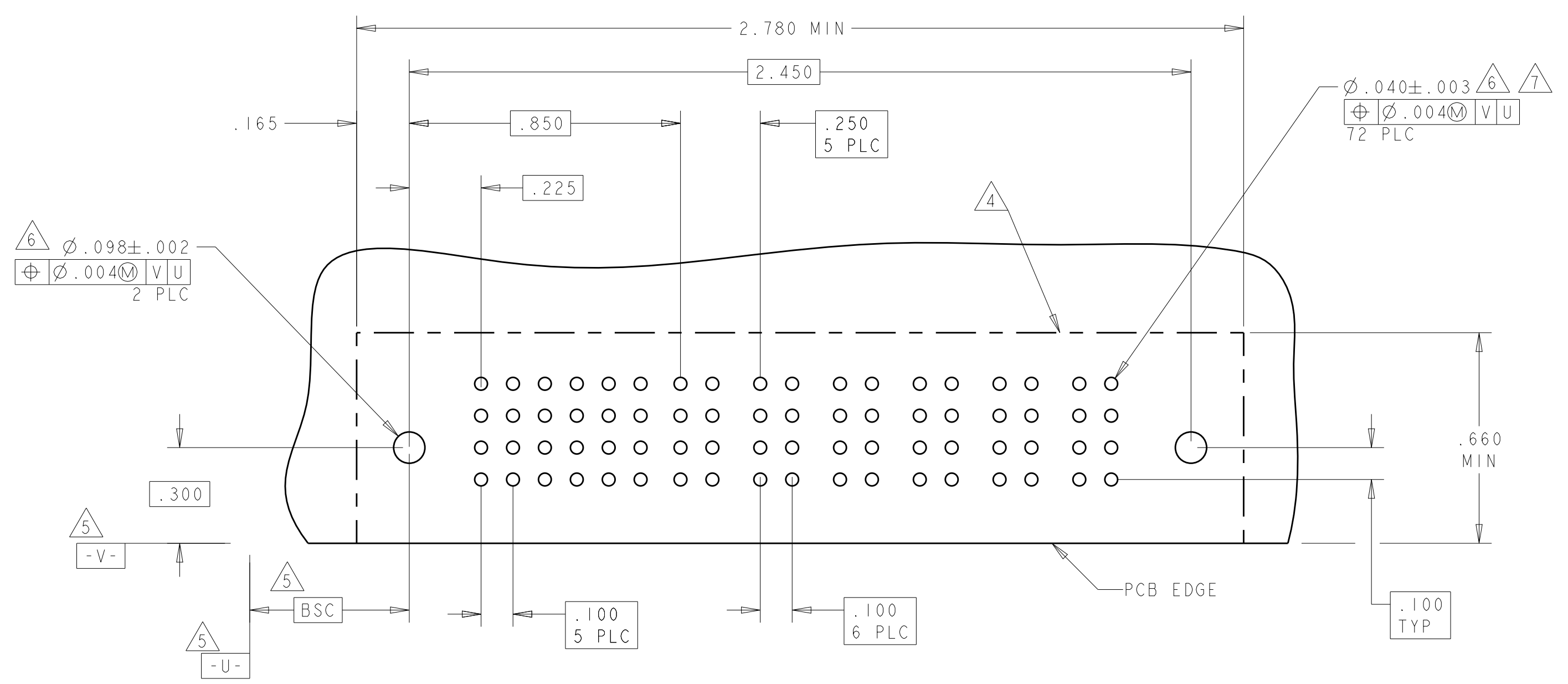

THIS DRAWING IS A CONTROLLED DOCUMENT.

DIMENSIONS:	TOLERANCES UNLESS OTHERWISE SPECIFIED:	DWN: R. GRZYBOWSKI 15FEB05	CHK: M. PERCHERKE 15FEB05
INCHES	0 PLC ±.01 1 PLC ±.01 2 PLC ±.01 3 PLC ±.005 4 PLC ±.002	APVD: M. PERCHERKE	NAME: M. PERCHERKE
MATERIAL:	FINISH: 2*	PRODUCT SPEC: 108-1973	APPLICATION SPEC: 114-13038
		WEIGHT: A100779	CAGE CODE: 6450131
		CUSTOMER DRAWING	SCALE: 1:1 SHEET 4 OF 9 REV: E9

**STE** TE Connectivity  
RIGHT ANGLE HEADER ASSY  
SOLDER CONTACTS, W/GUIDES  
MULTI-BEAM XL

LOC		DIST		REVISIONS			
ES	00	P	LTN	DESCRIPTION	DATE	OWN	APVD
				SEE SHEET 1			

PART NUMBER	ROWS	SIGNAL						POWER							
		1	2	3	4	5	6	P1	P2	P3	P4	P5	P6		
1-6450131-4	D	J	J	J	J	J	J	PM	PM	PM	PM	PM	PM		
	C	K	K	K	K	K	K								
	B	N	N	N	G	N	N								
	A	S	S	S	H	S	S								
24S + 6P		HD												HD	

PART NUMBER	ROWS	SIGNAL					POWER								
		1	2	3	4	5	P1	P2	P3	P4	P5	P6	P7	P8	
1-6450131-5	D	J	J	J	J	J	PM	PM	PM	PM	PM	PM	PM	PM	
	C	K	K	K	K	K									
	B	N	G	N	N	N									
	A	S	S	S	S	S									
20S + 8P		HD												HD	

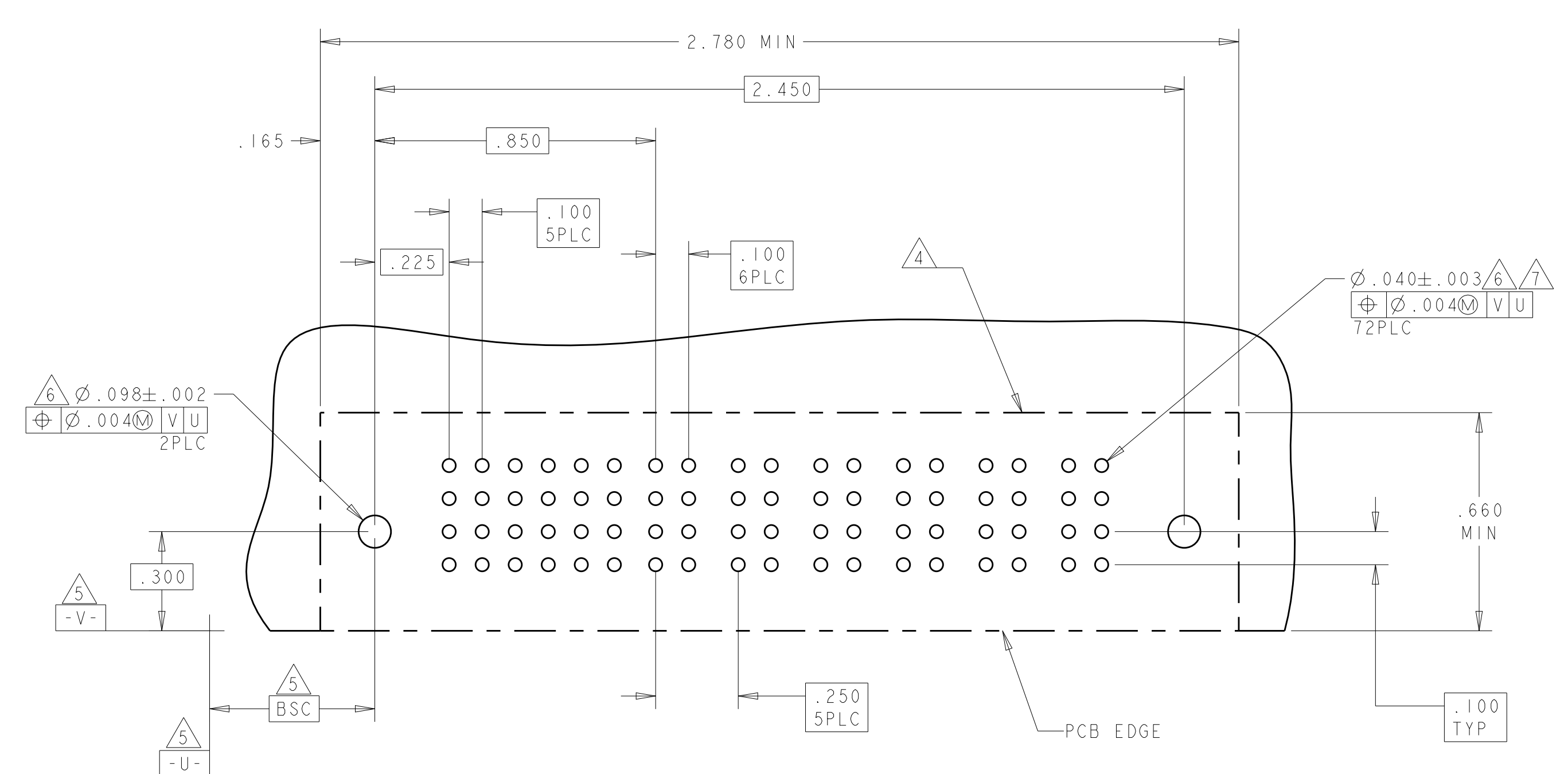
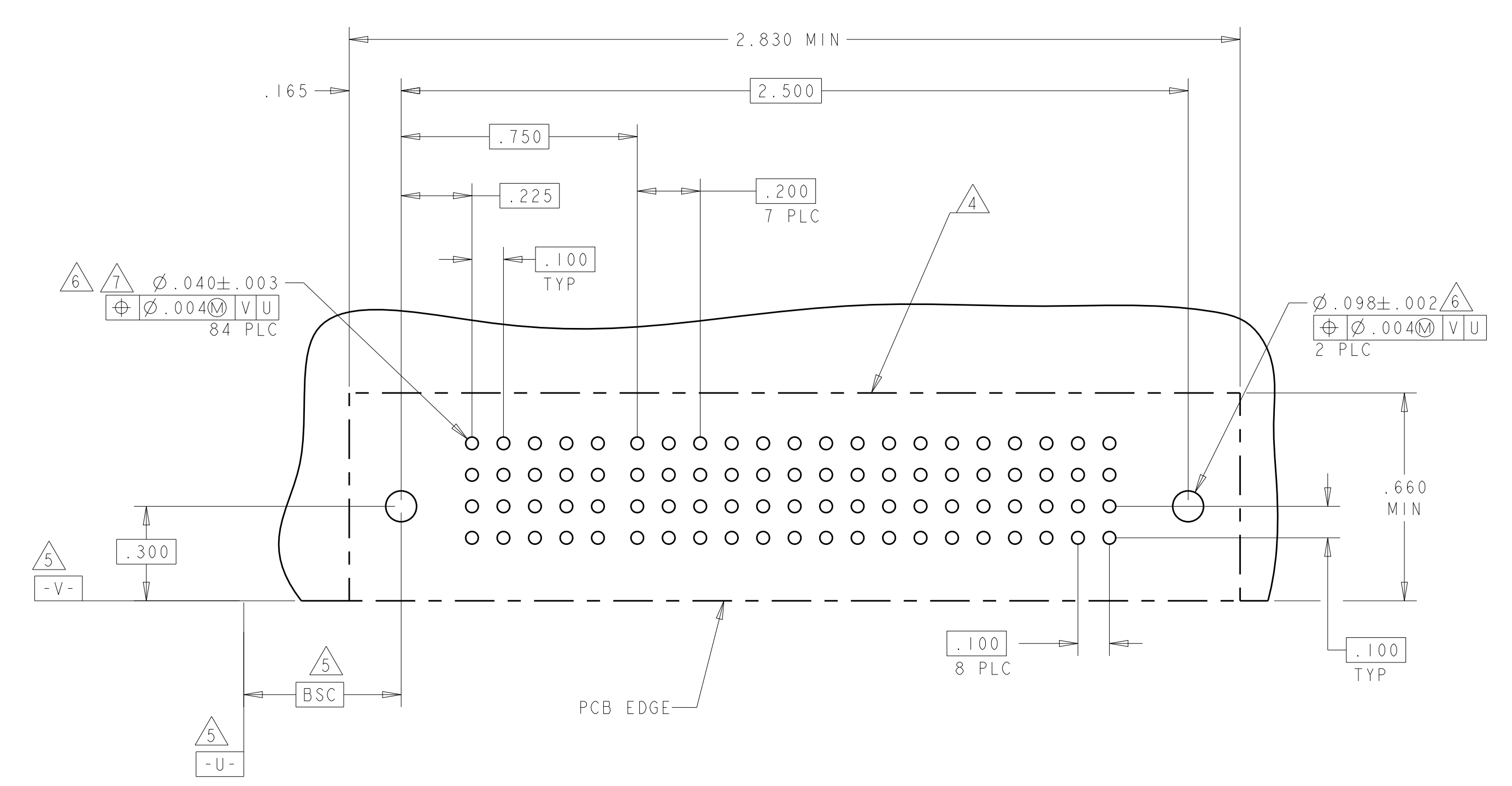
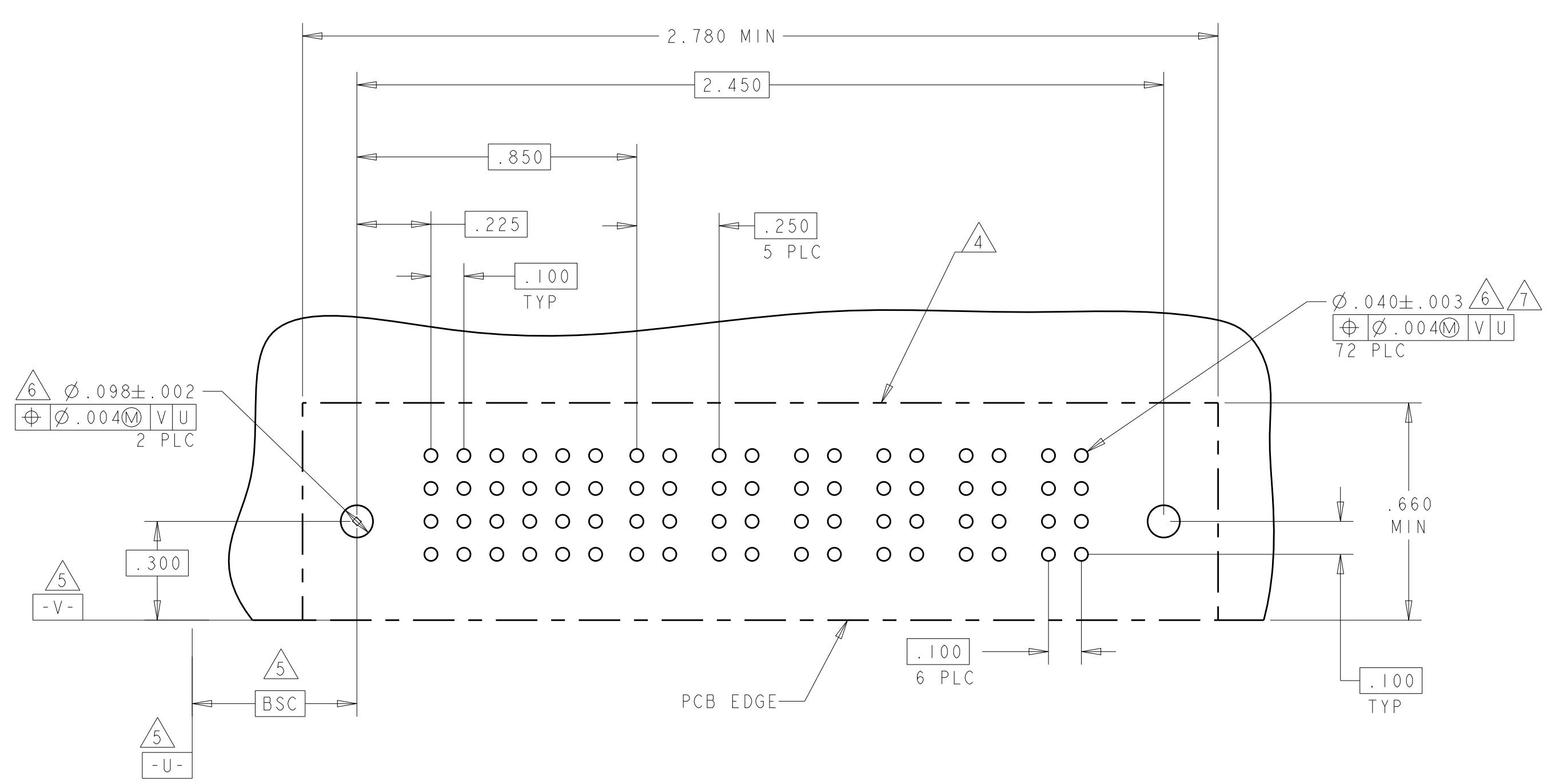

PART NUMBER	ROWS	SIGNAL						POWER							
		1	2	3	4	5	6	P1	P2	P3	P4	P5	P6		
1-6450131-6	D	J	J	J	J	J	E	PM	PM	PM	PM	PM	PM		
	C	K	K	K	K	K	K								
	B	N	N	N	N	N	N								
	A	H	S	S	S	S	S								
24S + 6P		HD												HD	

THIS DRAWING IS A CONTROLLED DOCUMENT. **STE** TE Connectivity

DIMENSIONS: INCHES	TOLERANCES UNLESS OTHERWISE SPECIFIED:	OWN: R. GRZYBOWSKI 15FEB05	CHK: M. PERCHERKE 15FEB05
	0 PLC ±.010 2 PLC ±.010 3 PLC ±.010 4 PLC ±.005 ANGLES ±.0020	APVD: M. PERCHERKE	NAME: M. PERCHERKE
MATERIAL:	FINISH:	PRODUCT SPEC: 108-1973	APPLICATION SPEC: 114-13038
		WEIGHT:	SIZE: CAGE CODE: DRAWING NO: A100779
		CUSTOMER DRAWING	SCALE: 1:1 SHEET 5 OF 9 REV: E9

LOC	DIST	REVISIONS			
P	LTN	DESCRIPTION	DATE	DMN	APVD
-	-	SEE SHEET 1	-	-	-

PART NUMBER	ROWS	SIGNAL						POWER									
		1	2	3	4	5	6	P1	P2	P3	P4	P5	P6	P7	P8	P9	P10
1-6450131-7	D	J	J	J	J	J	J	PM	PM	PM	PM	PM	PM	PM	PM	PM	PM
	C	K	K	K	F	K	K	PM	PM	PM	PM	PM	PM	PM	PM	PM	PM
	B	N	N	N	N	N	N	PM	PM	PM	PM	PM	PM	PM	PM	PM	PM
A	A	S	S	S	S	S	S	PM	PM	PM	PM	PM	PM	PM	PM	PM	PM
24S + 10HDP																	

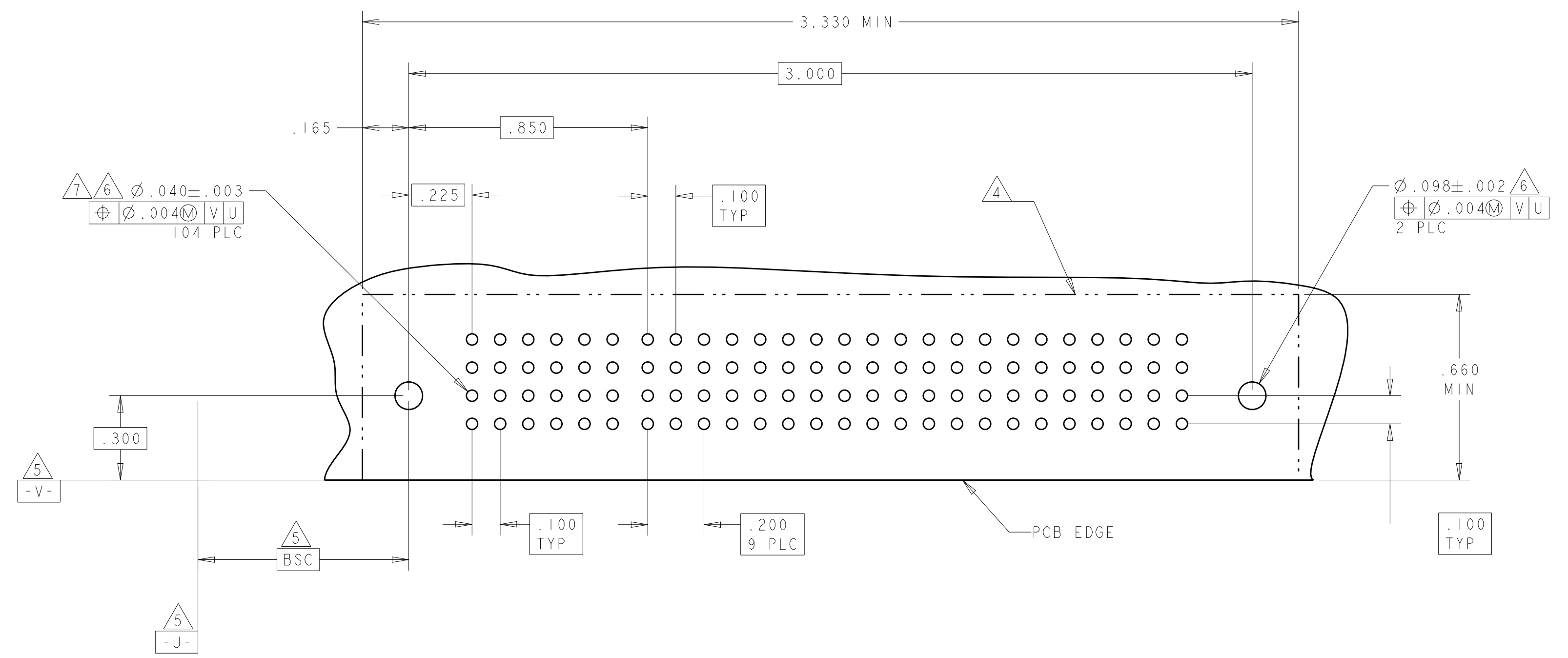

THIS DRAWING IS A CONTROLLED DOCUMENT.

DWN: R. GRZYBOWSKI	15FEB05	 TE Connectivity
CHK: M. PERCHERKE	15FEB05	
APVD: M. PERCHERKE		NAME: RIGHT ANGLE HEADER ASSY
		PRODUCT SPEC: 108-1973
		APPLICATION SPEC: 114-13038
		SIZE: 114-13038
		WEIGHT:
		CUSTOMER DRAWING

SCALE: 1:1 SHEET 6 OF 9 REV: E9

LOC	DIST	REVISIONS			
P	LTN	DESCRIPTION	DATE	DMN	APVD
-	-	SEE SHEET 1	-	-	-

PART NUMBER	ROWS	SIGNAL								POWER											
		1	2	3	4	5	6	7	8	P1	P2	P3	P4	P5	P6	P7	P8	P9	P10		
I-6450131-8	D	J	J	J	J	J	J	J	J	PM	PM	PM	PM	PM	PM	PM	PM	PM	PM		
	C	K	K	K	F	F	K	K	K												
	B	N	N	N	G	G	N	N	N												
	A	S	S	S	S	S	S	S	S												
32S + 10P		HD																		HD	

PART NUMBER	ROWS	SIGNAL			POWER				
		1	2	3	P1	P2	P3	P4	
I-6450131-9	D	J	FJ	FJ					
	C	K	K	K	PM	PM	PM	PM	
	B	N	N	N					
	A	H	H	S					
12S + 4P		HD						HD	

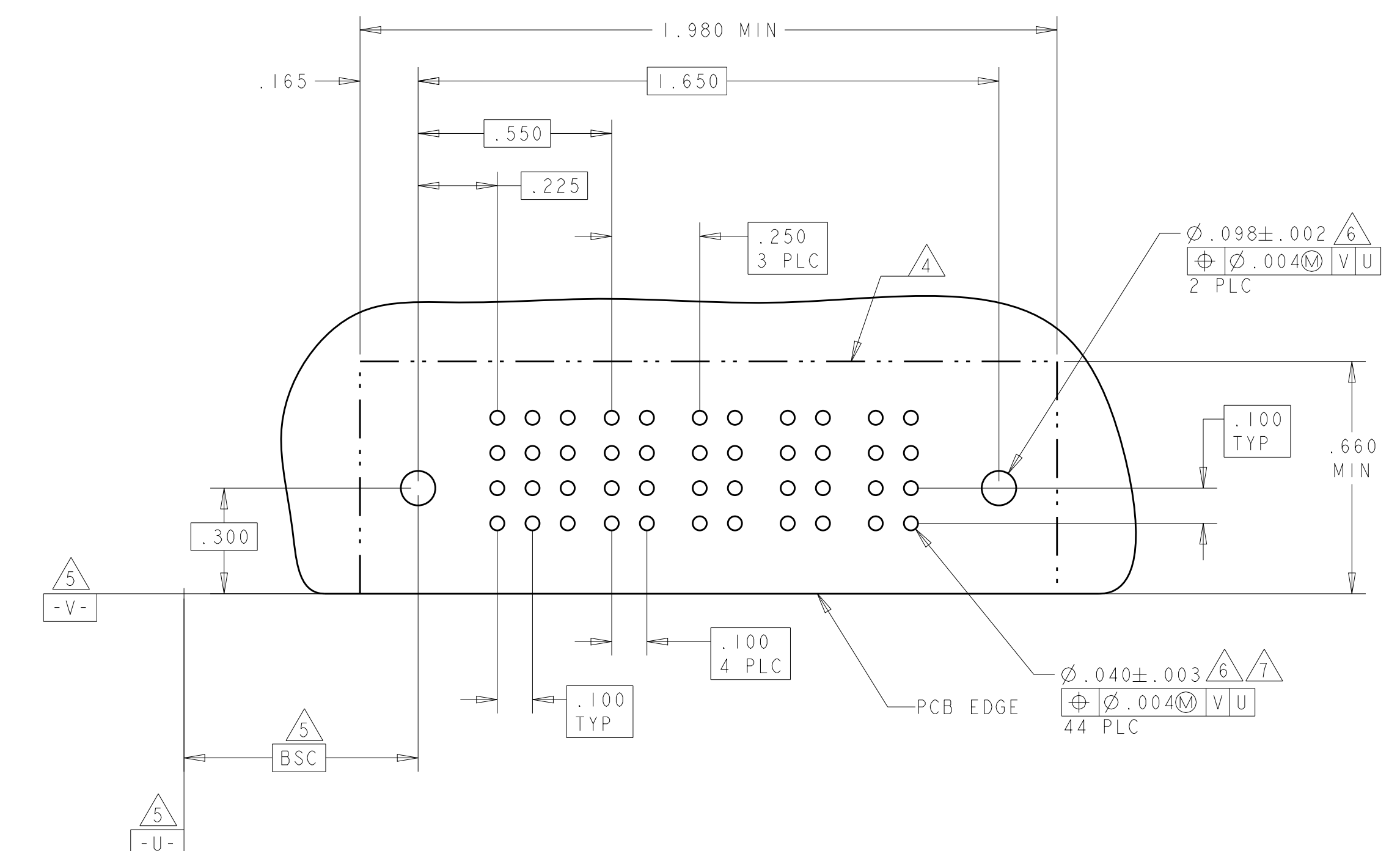
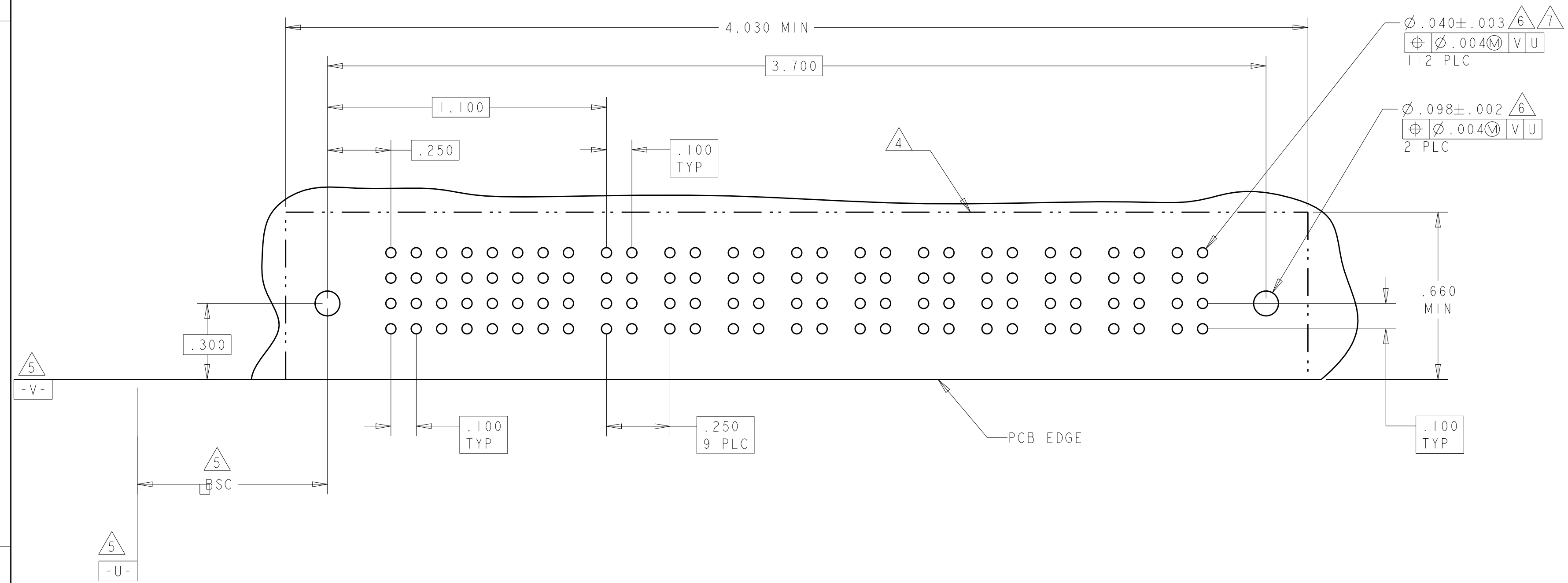

THIS DRAWING IS A CONTROLLED DOCUMENT.

DIMENSIONS: INCHES	TOLERANCES UNLESS OTHERWISE SPECIFIED: 0 PLC ±. 2 PLC ±.01 3 PLC ±.005 4 PLC ±.0020 ANGLES ±.2°	FINISH	APVD: M. PERCHERKE	NAME: M. PERCHERKE	DATE: 108-1973	PRODUCT SPEC: 108-1973	APPLICATION SPEC: 114-13038	WEIGHT: -	SCALE: 1:1	SHEET: 7 OF 9	REV: E9
-----------------------	--	--------	--------------------	--------------------	----------------	------------------------	-----------------------------	-----------	------------	---------------	---------

**STE** TE Connectivity

RIGHT ANGLE HEADER ASSY  
 SOLDER CONTACTS, W/GUIDES  
 MULTI-BEAM XL

CAGE CODE: A100779  
 DRAWING NO: C=6450131

CUSTOMER DRAWING

LOC	DIST	REVISIONS			
P	LTN	DESCRIPTION	DATE	DMN	APVD
-	-	SEE SHEET 1	-	-	-

PART NUMBER	ROWS	POWER		SIGNAL						POWER	
		P1	P2	1	2	3	4	5	6	P3	P4
2-6450131-1	D	HD	[ ]	J	J	J	J	J	J	[ ]	HD
	C			K	K	K	K	K	F		
	B			N	N	N	N	N	N		
	A			S	S	S	S	S	S		

24S

NO CONTACT LOADED

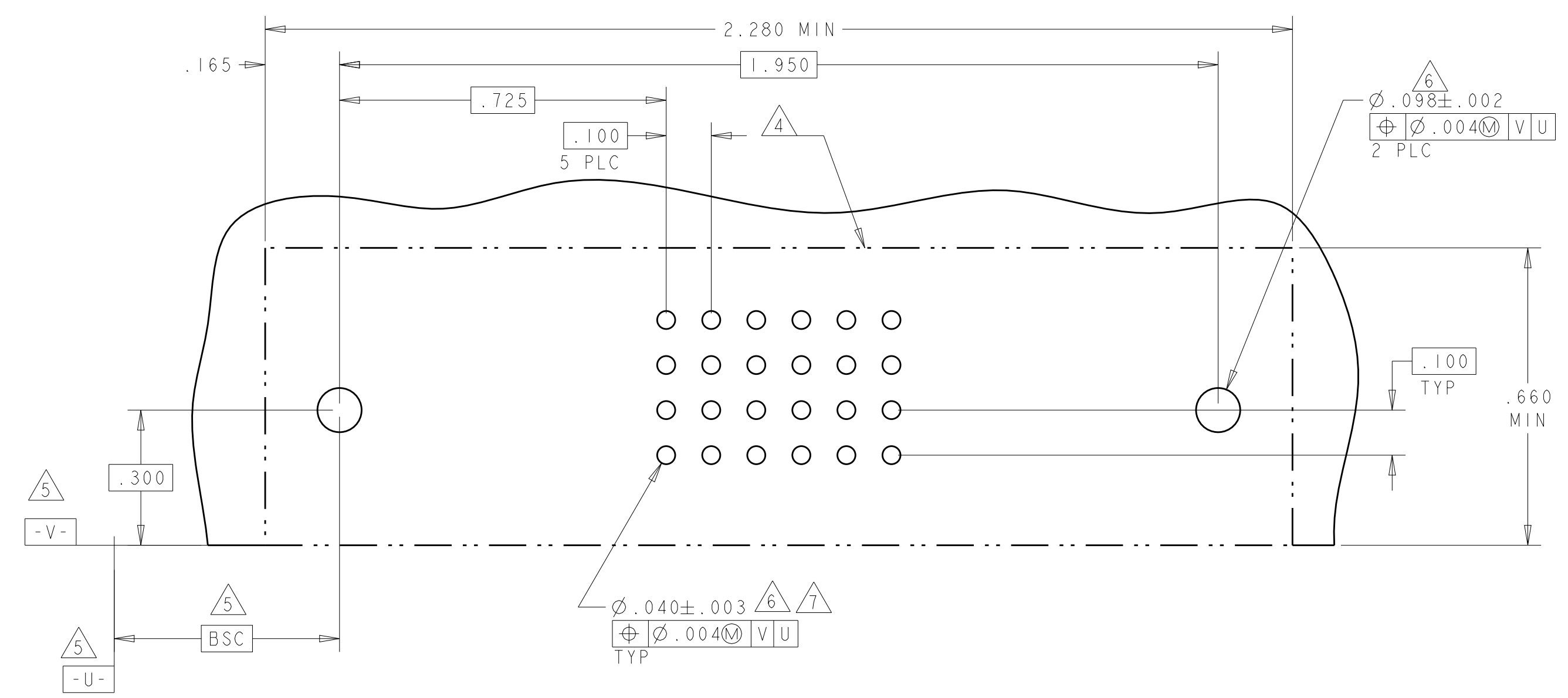

PART NUMBER	ROWS	SIGNAL				POWER			
		1	2	3	4	P1	P2	P3	P4
2-6450131-2	D	J	J	J	J	PM	PM	PM	PM
	C	K	K	K	K				
	B	N	N	N	N				
	A	H	S	S	S				

16S + 4P

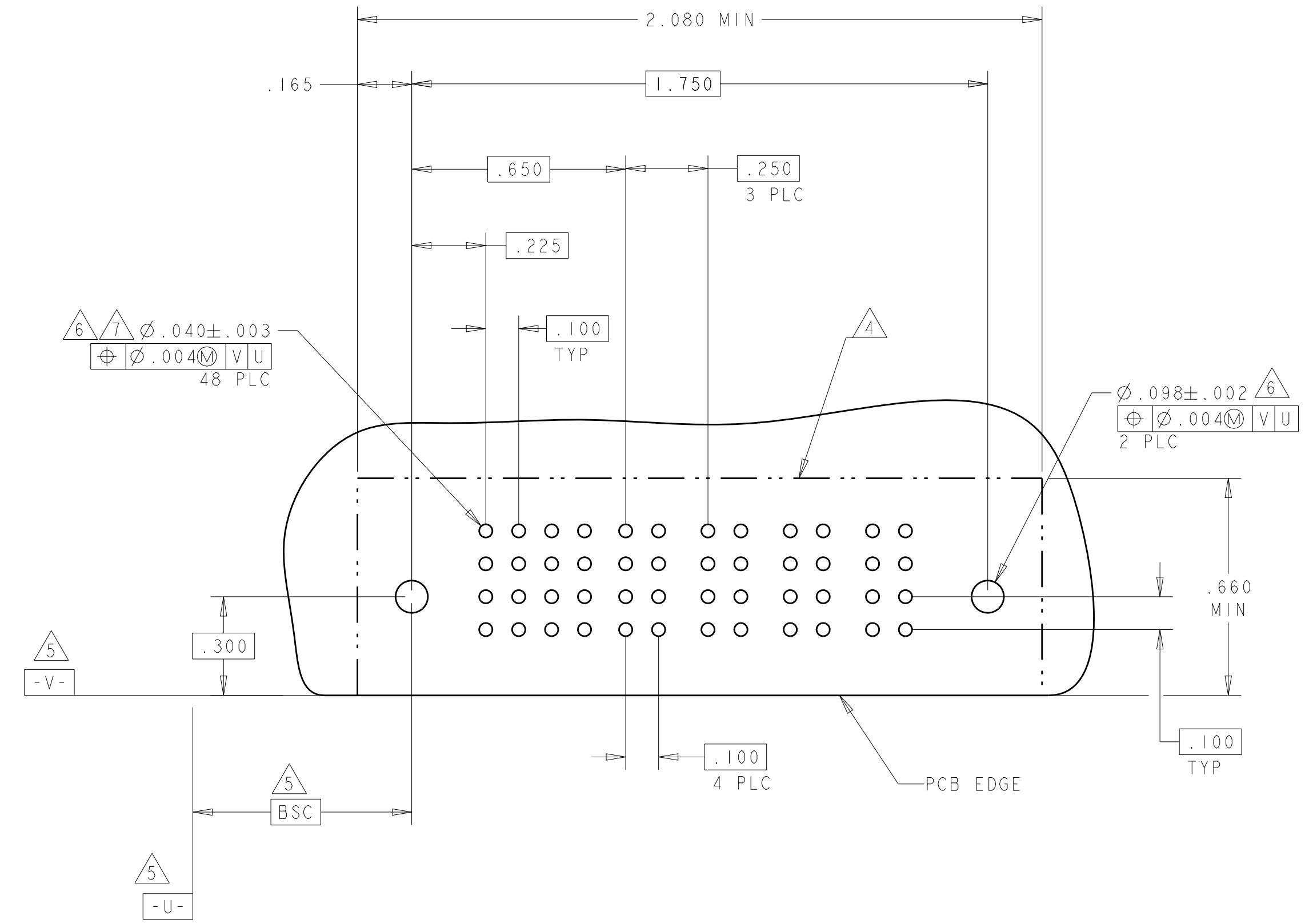

THIS DRAWING IS A CONTROLLED DOCUMENT.

DIMENSIONS: INCHES	TOLERANCES UNLESS OTHERWISE SPECIFIED: 0 PLC ±. 1 PLC ±.01 2 PLC ±.01 3 PLC ±.005 4 PLC ±.0020 ANGLES ±.7°	FINISH	DMN: R. GRZYBOWSKI 15FEB05 CHK: M. PERCHERKE 15FEB05 APVD: M. PERCHERKE	NAME: RIGHT ANGLE HEADER ASSY PRODUCT SPEC: 108-1973 APPLICATION SPEC: 114-13038 WEIGHT: - CUSTOMER DRAWING	SIZE: A1 CAGE CODE: 6450131 DRAWING NO: 100779	RESTRICTED TO: -
-----------------------	--	--------	---	---	--	------------------

STE TE Connectivity

SCALE: 1:1 SHEET 8 OF 9 REV: E9



LOC	DIST	REVISIONS					
ES	00	P	LTN	DESCRIPTION	DATE	DWN	APVD
		-		SEE SHEET 1			

PART NUMBER	ROWS	SIGNAL												POWER												
		1	2	3	4	5	6	7	8	9	10	11	12	13	P1	P2	P3	P4	P5	P6	P7	P8	P9	P10	P11	P12
2-6450131-3	D	J	J	J	J	J	J	J	J	J	J	J	J	J	PM	PM	PM	PM	PM	PM	PM	PM	PM	PM	PM	PM
	C	K	K	K	K	K	F	F	K	K	K	K	K													
	B	N	N	N	N	N	G	G	N	N	N	N	N													
	A	S	S	S	S	S	S	S	S	S	S	S	S													
52S + 12P		HD												HD												

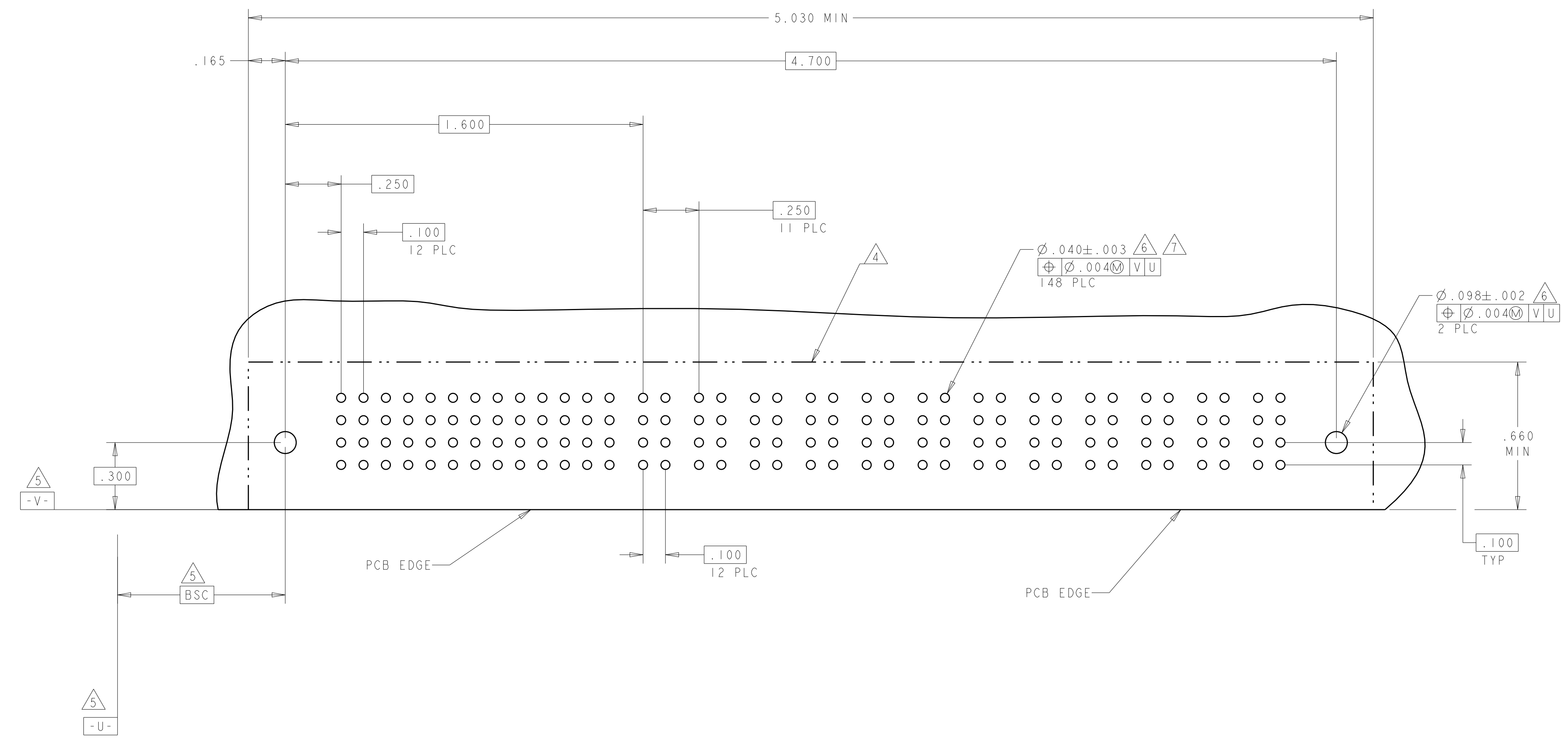

THIS DRAWING IS A CONTROLLED DOCUMENT.		DWN: R. GRZYBOWSKI 15FEB05	TE Connectivity										
DIMENSIONS: INCHES		CHK: M. PERCHERKE 15FEB05											
TOLERANCES UNLESS OTHERWISE SPECIFIED:		APVD: M. PERCHERKE	NAME: RIGHT ANGLE HEADER ASSY										
<table border="1"> <tr><td>0 PLC</td><td>±</td></tr> <tr><td>2 PLC</td><td>±.01</td></tr> <tr><td>3 PLC</td><td>±.05</td></tr> <tr><td>4 PLC</td><td>±.0020</td></tr> <tr><td>ANGLES</td><td>±2°</td></tr> </table>		0 PLC	±	2 PLC	±.01	3 PLC	±.05	4 PLC	±.0020	ANGLES	±2°	PRODUCT SPEC: 108-1973	RESTRICTED TO:
0 PLC	±												
2 PLC	±.01												
3 PLC	±.05												
4 PLC	±.0020												
ANGLES	±2°												
MATERIAL: -		APPLICATION SPEC: 114-13038	SIZE: A1										
FINISH: -		WEIGHT: -	CAGE CODE: 6450131										
CUSTOMER DRAWING		SCALE: 1:1	SHEET 9 OF 9										

Компания «Life Electronics» занимается поставками электронных компонентов импортного и отечественного производства от производителей и со складов крупных дистрибьюторов Европы, Америки и Азии.

С конца 2013 года компания активно расширяет линейку поставок компонентов по направлению коаксиальный кабель, кварцевые генераторы и конденсаторы (керамические, пленочные, электролитические), за счёт заключения дистрибьюторских договоров

Мы предлагаем:

- Конкурентоспособные цены и скидки постоянным клиентам.
- Специальные условия для постоянных клиентов.
- Подбор аналогов.
- Поставку компонентов в любых объемах, удовлетворяющих вашим потребностям.
- Приемлемые сроки поставки, возможна ускоренная поставка.
- Доставку товара в любую точку России и стран СНГ.
- Комплексную поставку.
- Работу по проектам и поставку образцов.
- Формирование склада под заказчика.
- Сертификаты соответствия на поставляемую продукцию (по желанию клиента).
- Тестирование поставляемой продукции.
- Поставку компонентов, требующих военную и космическую приемку.
- Входной контроль качества.
- Наличие сертификата ISO.

В составе нашей компании организован Конструкторский отдел, призванный помогать разработчикам, и инженерам.

Конструкторский отдел помогает осуществить:

- Регистрацию проекта у производителя компонентов.
- Техническую поддержку проекта.
- Защиту от снятия компонента с производства.
- Оценку стоимости проекта по компонентам.
- Изготовление тестовой платы монтаж и пусконаладочные работы.



Тел: +7 (812) 336 43 04 (многоканальный)  
Email: [org@lifeelectronics.ru](mailto:org@lifeelectronics.ru)