

Features

- 5mm Through hole, 8.65mm lens height
- High Brightness
- Water Clear lens
- InGaN / AlInGaP Technology
- Special packaging available upon request
- High reliability

Applications

- Consumer Electronics
- Variable Message Signs (VMS)
- Automobile After Market
- Industrial Equipment
- Advertising Signs

Description

The INL-5AX30 is high brightness 30 degrees through-hole lamp. It is a 5mm epoxy type LED which can be used in various applications.

Package Dimensions in mm

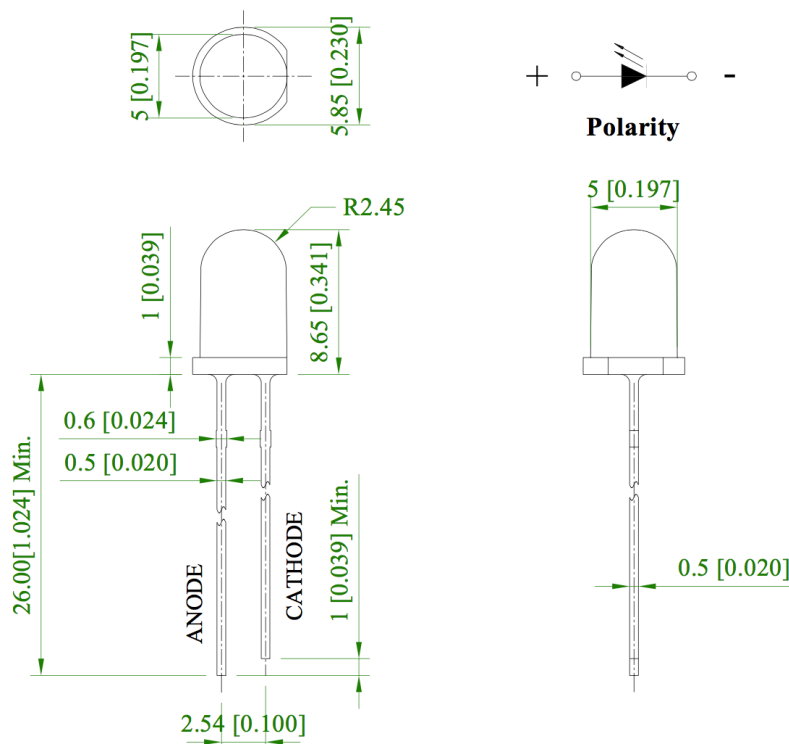

Figure 1. INL-5AX30 Package Dimensions

Absolute Maximum Rating at 25°C (Note 1)

Product	Emission Color	P_d (mW)	I_F (mA)	I_{FP}^* (mA)	V_R (V)	T_{OP} (°C)	T_{ST} (°C)
INL-5AYG30	Yellow Green	65	25	100	5	-40°C~+85°C	-40°C~+100°C
INL5AY30	Yellow						
INL5AA30	Amber						
INL5AR30	Red						
INL5AB30	Blue	95	25	100			
INL5AG30	Green						
INL5AW30	White						

Notes

1. Condition for I_{FP} is pulse of 1/10 duty and 0.1msec width

Electrical Characteristics $T_A = 25^\circ\text{C}$ (Note 1)

Product	Emission Color	$I_F(\text{mA})$	$V_F(\text{V})$		$\lambda(\text{nm})$			Viewing Angle	$I_v(\text{mcd})$	
			min	max	λ_D	λ_P	$\Delta\lambda$	$2\theta_{1/2}$	min	typ.
INL-5AYG30	Yellow Green	20	1.6	2.6	573	575	20	30	270	460
INL5AY30	Yellow	20	1.6	2.6	590	592	15	30	600	1000
INL5AA30	Amber	20	1.6	2.6	605	610	35	30	460	780
INL5AR30	Red	20	1.6	2.6	624	632	20	30	780	1300
INL5AB30	Blue	20	2.6	3.8	470	468	25	30	2900	5000
INL5AG30	Green	20	2.6	3.6	525	520	35	30	14000	23000
INL5AW30	White	20	2.8	3.8	X = 0.28 Y = 0.28			30	6500	8500

Notes

1. Performance guaranteed only under conditions listed in above tables.

ESD Precaution

ATTENTION: Electrostatic Discharge (ESD) protection



The symbol above denotes that ESD precaution is needed. ESD protection for GaP and AlGaAs based chips is necessary even though they are relatively safe in the presence of low static-electric discharge. Parts built with AlInGaP, GaN, or/and InGaN based chips are STATIC SENSITIVE devices. ESD precaution must be taken during design and assembly. If manual work or processing is needed, please ensure the device is adequately protected from ESD during the process.

Please be advised that normal static precautions should be taken in the handling and assembly of this device to prevent damage or degradation which may be induced by electrostatic discharge (ESD).

Chromaticity Bin (For White Only)

Bin Code	Left x	Left y	Top x	Top y	Right x	Right y	Bottom x	Bottom y
C1-1	0.256	0.28	0.264	0.289	0.268	0.283	0.26	0.274
C2-1	0.26	0.274	0.268	0.283	0.272	0.277	0.264	0.269
C3-1	0.264	0.269	0.272	0.277	0.276	0.271	0.269	0.263
C4-1	0.269	0.263	0.276	0.271	0.28	0.265	0.273	0.257
C1-2	0.264	0.289	0.273	0.299	0.276	0.293	0.268	0.283
C2-2	0.268	0.283	0.276	0.293	0.279	0.286	0.272	0.277
C3-2	0.272	0.277	0.279	0.286	0.283	0.279	0.276	0.271
C4-2	0.276	0.271	0.283	0.279	0.286	0.273	0.28	0.265
C1-3	0.273	0.299	0.281	0.309	0.284	0.302	0.276	0.293
C2-3	0.276	0.293	0.284	0.302	0.287	0.295	0.279	0.286
C3-3	0.279	0.286	0.287	0.295	0.29	0.287	0.283	0.279
C4-3	0.283	0.279	0.29	0.287	0.292	0.28	0.286	0.273
D1-1	0.281	0.309	0.288	0.317	0.291	0.309	0.284	0.302
D2-1	0.284	0.302	0.291	0.309	0.293	0.302	0.287	0.295
D3-1	0.287	0.295	0.293	0.302	0.296	0.294	0.29	0.287
D4-1	0.29	0.287	0.296	0.294	0.298	0.286	0.292	0.28
D1-2	0.288	0.317	0.296	0.325	0.298	0.317	0.291	0.309
D2-2	0.291	0.309	0.298	0.317	0.3	0.308	0.293	0.302
D3-2	0.293	0.302	0.3	0.308	0.302	0.3	0.296	0.294
D4-2	0.296	0.294	0.302	0.3	0.304	0.292	0.298	0.286
D1-3	0.296	0.325	0.303	0.333	0.305	0.324	0.298	0.317
D2-3	0.298	0.317	0.305	0.324	0.307	0.315	0.3	0.308
D3-3	0.3	0.308	0.307	0.315	0.308	0.307	0.302	0.3
D4-3	0.302	0.3	0.308	0.307	0.31	0.298	0.304	0.292
E1-1	0.303	0.333	0.313	0.342	0.314	0.333	0.305	0.324
E2-1	0.305	0.324	0.314	0.333	0.315	0.324	0.307	0.315
E3-1	0.307	0.315	0.315	0.324	0.316	0.314	0.308	0.307
E4-1	0.308	0.307	0.316	0.314	0.317	0.305	0.31	0.298
E1-2	0.313	0.342	0.323	0.351	0.323	0.341	0.314	0.333
E2-2	0.314	0.333	0.323	0.341	0.324	0.332	0.315	0.324
E3-2	0.315	0.324	0.324	0.332	0.324	0.322	0.316	0.314
E4-2	0.316	0.314	0.324	0.322	0.324	0.313	0.317	0.305
E1-3	0.323	0.351	0.333	0.36	0.333	0.35	0.323	0.341
E2-3	0.324	0.332	0.333	0.35	0.332	0.34	0.324	0.331
E3-3	0.324	0.332	0.332	0.34	0.332	0.33	0.324	0.322
E4-3	0.324	0.322	0.332	0.33	0.332	0.32	0.324	0.313

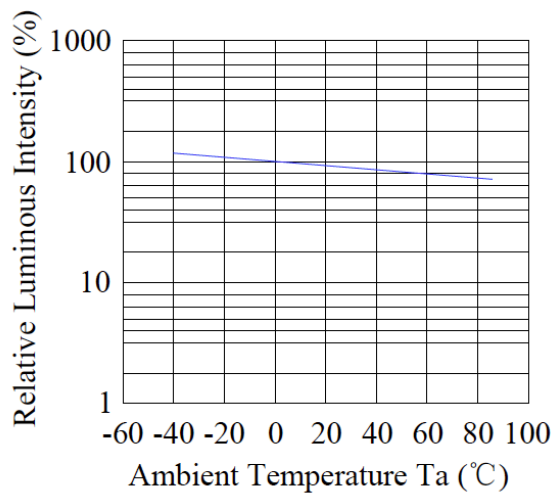
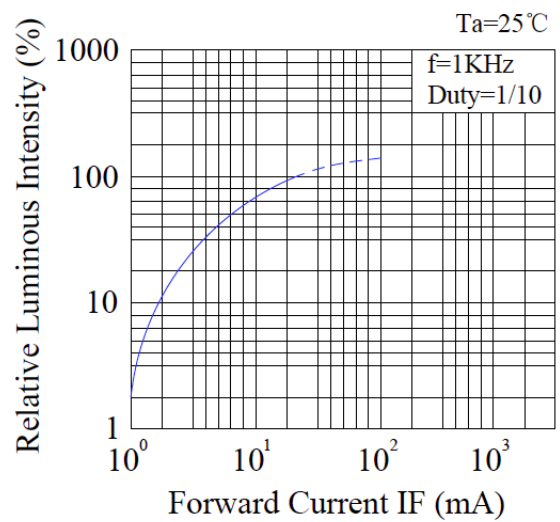
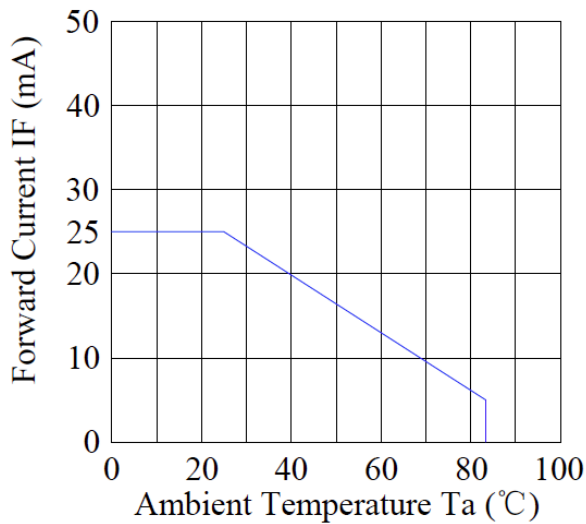
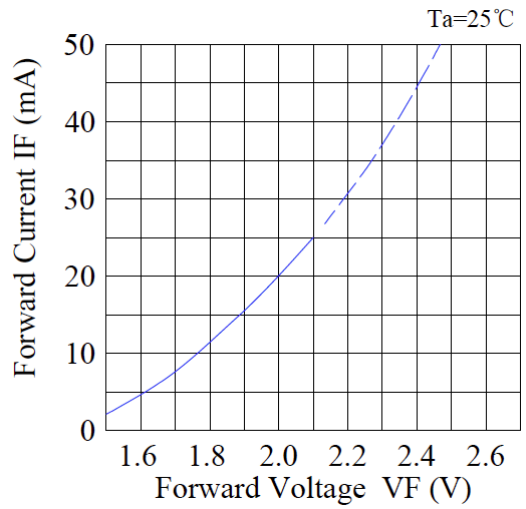
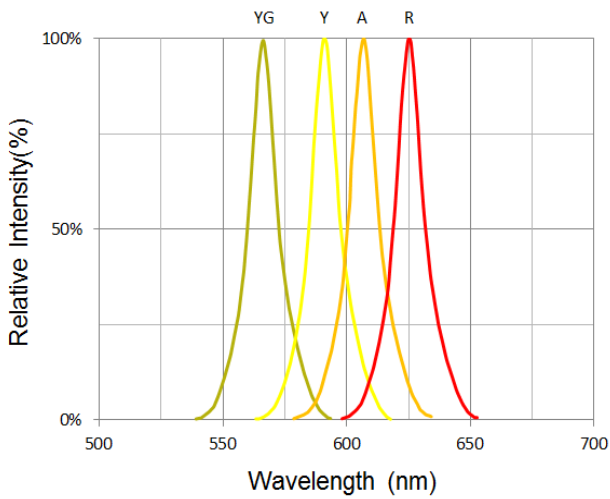
Typical Characteristic Curves – YG, Y, A, R

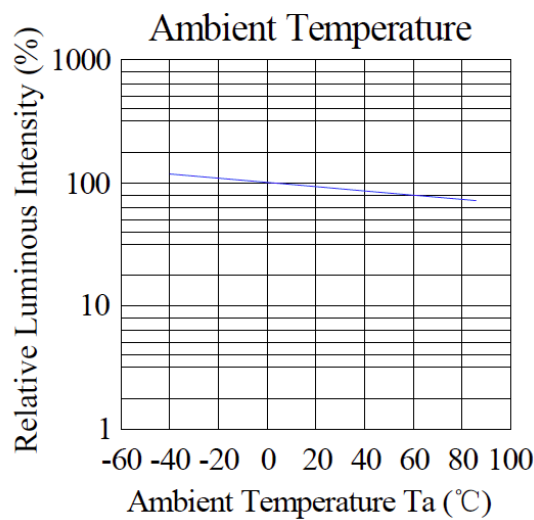
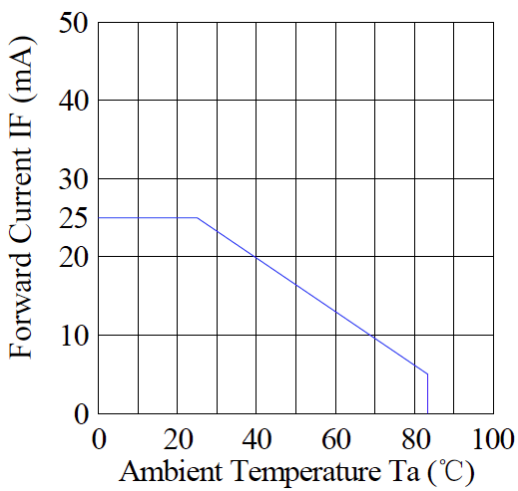
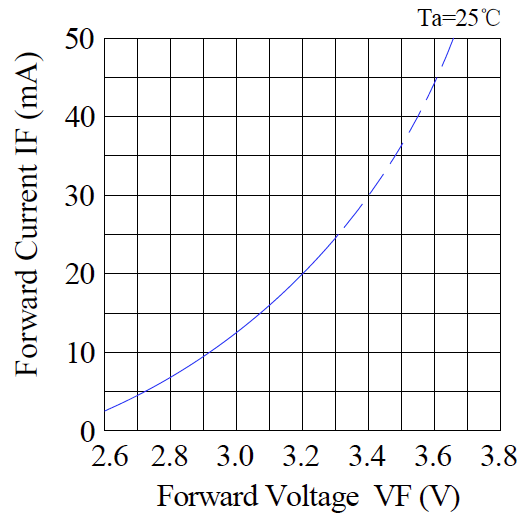
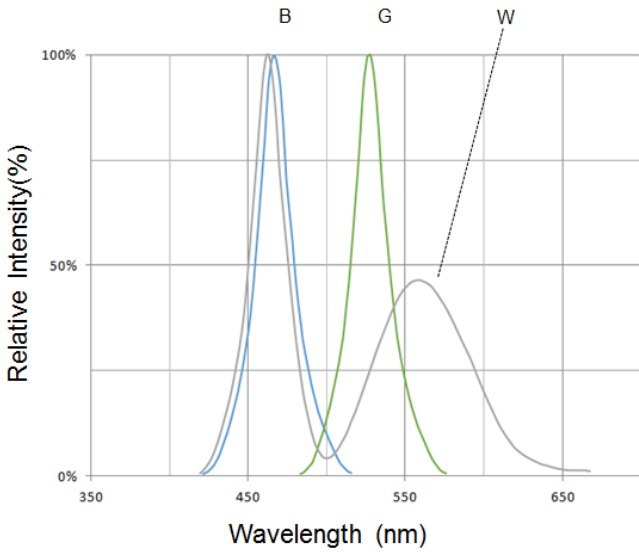
Typical Characteristic Curves – B, G, W

Typical Characteristic Curves – Radiation Pattern

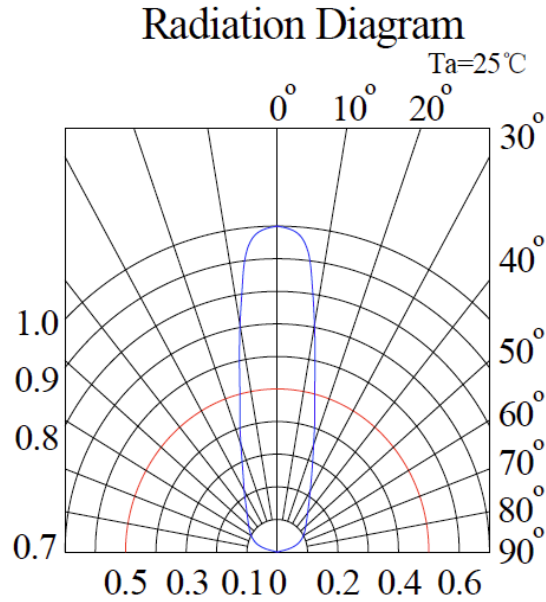

Ordering Information

Product	Emission Color	Technology	Test Current I_F (mA)	Luminous Intensity I_V (mcd) (Typ.)	Forward Voltage V_F (V) (Typ.)	Orderable Part Number
INL-5AYG30	Yellow Green	AlInGaP	20	460	2.0	INL-5AYG30
INL5AY30	Yellow	AlInGaP	20	1000	2.0	INL5AY30
INL5AA30	Amber	AlInGaP	20	780	2.0	INL5AA30
INL5AR30	Red	AlInGaP	20	1300	2.0	INL5AR30
INL5AB30	Blue	InGaN	20	5000	3.2	INL5AB30
INL5AG30	Green	InGaN	20	23000	3.2	INL5AG30
INL5AW30	White	InGaN	20	8500	3.3	INL5AW30

Label Specifications

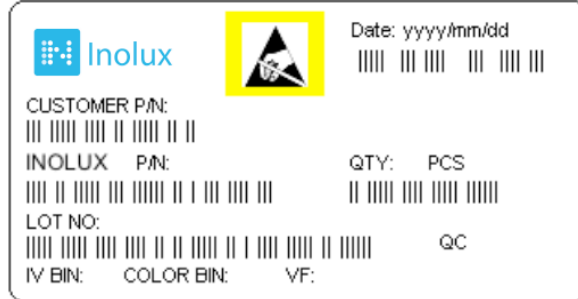

Inolux P/N:

I	N	L	-	5	A		Y	3	0	-	X	X	X	X
Inolux Through Hole Lamp		Material	Lens	Color	View Angle	Customized Stamp-off								
		5A = 5mm with flange, 8.65 height	(Blank) = Clear Lens	R=636nm A=609nm Y=593nm YG=574nm G=530nm B=468nm W=White	30 = 30 deg.									

Lot No.:

Z	2	0	1	7	01	24	001
Internal Tracker	Year (2017, 2018,)				Month	Date	Serial

Soldering

Recommended soldering conditions:



Soldering Iron

Basic Spec is Max 3 sec. @ 300°C. Lamps without stopper must leave a min. of 3mm clearance from base of the lens to the soldering point.

Rework

Caution is advised when rework is performed. Rework should be completed within 4 second under 245°C using a double-headed soldering iron.

Reliability

Item	Frequency/ lots/ samples/ failures	Standards Reference	Conditions
Precondition	For all reliability monitoring tests according to JEDEC Level 2	J-STD-020	1.) Baking at 85°C for 24hrs 2.) Moisture storage at 85°C/ 60% R.H. for 168hrs
Solderability	1Q/ 1/ 22/ 0	JESD22-B102-B And CNS-5068	Accelerated aging 155°C/ 24hrs Tinning speed: 2.5+0.5cm/s Tinning: A: 215°C/ 3+1s or B: 260°C/ 10+1s
Resistance to soldering heat		CNS-5067	Dipping soldering terminal only Soldering bath temperature A: 260+/-5°C; 10+/-1s B: 350+/-10°C; 3+/-0.5s
Operating life test	1Q/ 1/ 40/ 0	CNS-11829	1.) Precondition: 85°C baking for 24hrs 85°C/ 60%R.H. for 168hrs 2.) Tamb25°C; IF=20mA; duration 1000hrs
High humidity, high temperature bias	1Q/ 1/ 45/ 0	JESD-A101-B	Tamb: 85°C Humidity: 85% R.H., IF=5mA Duration: 1000hrs
High temperature bias	1Q/ 1/ 20	IN specs.	Tamb: 55°C IF=20mA Duration: 1000hrs
Pulse life test	1Q/ 1/ 40/ 0		Tamb25°C, If=20mA,, Ip=100mA, Duty cycle=0.125 (tp=125 μs, T=1sec) Duration 500hrs)
Temperature cycle	1Q/ 1/ 76/ 0	JESD-A104-A IEC 68-2-14, Nb	A cycle: -40 degree C 15min; +85 degree C 15min Thermal steady within 5 min.. 300 cycles 2 chamber/ Air-to-air type
High humidity storage test	1Q/ 1/ 40/ 0	CNS-6117	60+3°C 90+5/-10% R.H. for 500hrs
High temperature storage test	1Q/ 1/ 40/ 0	CNS-554	100+10°C for 500hrs
Low temperature storage test	1Q/ 1/ 40/ 0	CNS-6118	-40+5°C for 500hrs

Revision History

Changes since last revision	Page	Version No.	Revision Date
Initial Release		1.0	07-10-2017

DISCLAIMER

INOLUX reserves the right to make changes without further notice to any products herein to improve reliability, function or design. INOLUX does not assume any liability arising out of the application or use of any product or circuit described herein; neither does it convey any license under its patent rights, nor the rights of others.

LIFE SUPPORT POLICY

INOLUX's products are not authorized for use as critical components in life support devices or systems without the express written approval of the President of INOLUX or INOLUX CORPORATION. As used herein:

1. Life support devices or systems are devices or systems which, (a) are intended for surgical implant into the body, or (b) support or sustain life, and (c) whose failure to perform when properly used in accordance with instructions for use provided in the labeling, can be reasonably expected to result in a significant injury of the user.
2. A critical component in any component of a life support device or system whose failure to perform can be reasonably expected to cause the failure of the life support device or system, or to affect its safety or effectiveness.

Компания «Life Electronics» занимается поставками электронных компонентов импортного и отечественного производства от производителей и со складов крупных дистрибьюторов Европы, Америки и Азии.

С конца 2013 года компания активно расширяет линейку поставок компонентов по направлению коаксиальный кабель, кварцевые генераторы и конденсаторы (керамические, пленочные, электролитические), за счёт заключения дистрибьюторских договоров

Мы предлагаем:

- Конкурентоспособные цены и скидки постоянным клиентам.
- Специальные условия для постоянных клиентов.
- Подбор аналогов.
- Поставку компонентов в любых объемах, удовлетворяющих вашим потребностям.
- Приемлемые сроки поставки, возможна ускоренная поставка.
- Доставку товара в любую точку России и стран СНГ.
- Комплексную поставку.
- Работу по проектам и поставку образцов.
- Формирование склада под заказчика.
- Сертификаты соответствия на поставляемую продукцию (по желанию клиента).
- Тестирование поставляемой продукции.
- Поставку компонентов, требующих военную и космическую приемку.
- Входной контроль качества.
- Наличие сертификата ISO.

В составе нашей компании организован Конструкторский отдел, призванный помогать разработчикам, и инженерам.

Конструкторский отдел помогает осуществить:

- Регистрацию проекта у производителя компонентов.
- Техническую поддержку проекта.
- Защиту от снятия компонента с производства.
- Оценку стоимости проекта по компонентам.
- Изготовление тестовой платы монтаж и пусконаладочные работы.



Тел: +7 (812) 336 43 04 (многоканальный)
Email: org@lifeelectronics.ru