

4S1 & 4SS-Series
Sub-Miniature &
Sealed Sub-Miniature
Slide Switches

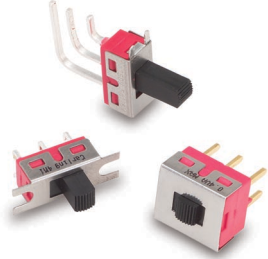

4M1-Series
Miniature Slide Switch

Specifications

Contact Rating refer to ordering scheme
 Electrical Life 30,000 make & break cycles at full load
 Contact Resistance. 10 mΩ max. initial @ 2-4 VDC
 100mA for both silver & gold plated contacts.
 Insulation Resistance 1000 MΩ min.
 Dielectric Strength 1500 Volts RMS @ sea level
 Operating Temperature . . . -30°C to +85°C
 Solder Heat Resistance. . . MIL-STD-202, Method 210
 Actuator Travel 25°

Materials
 Case Diallyl phthalate (DAP) (UL 94V-0)
 Slide Handle. Nylon
 Housing. Stainless Steel
 Terminal Seal Epoxy

4S1-Series Ordering Scheme



1 SERIES 4S1 Sub-Miniature Slide Switch																
2 POLES FSP single pole																
3 CIRCUIT <table style="width: 100%; border-collapse: collapse;"> <tr> <td colspan="4" style="text-align: center;">Switching Position:</td> </tr> <tr> <td style="width: 10%;"></td> <td style="width: 15%;">2-1</td> <td style="width: 20%;">OPEN</td> <td style="width: 15%;">2-3</td> </tr> <tr> <td>1</td> <td>ON</td> <td>NONE</td> <td>ON</td> </tr> <tr> <td>3</td> <td>ON</td> <td>OFF</td> <td>ON</td> </tr> </table>	Switching Position:					2-1	OPEN	2-3	1	ON	NONE	ON	3	ON	OFF	ON
Switching Position:																
	2-1	OPEN	2-3													
1	ON	NONE	ON													
3	ON	OFF	ON													
4 TERMINATION M2 PCB M6 PC Mount, 90° horizontal																

5 CONTACT		
<i>Material</i>	<i>Terminal Plating</i>	<i>Rating</i>
G silver ¹	gold over silver ³	3A@125VAC or 28VDC; 1.5A @ 250VAC
K gold ²	tin-lead ⁴	0.4VA max. @20V max (AC/DC)
P silver ¹	tin-lead ⁴	3A@125VAC or 28VDC; 1.5A @ 250VAC
Q silver ¹	silver ¹	3A@125VAC or 28VDC; 1.5A @ 250VAC
R gold ²	gold ²	0.4VA max. @20V max (AC/DC)
NOTE: Tin-lead option available with PC type terminations only. 1 Moveable contact & terminals: copper alloy, silver plate 2 Moveable contact & terminals: copper alloy with gold plate over nickel plate 3 Terminals: silver plate with outer layer in gold plating		

6 EPOXY SEAL E epoxy seal
--

7 PACKAGING Switches are bulk packed, unless T/R is specified at the end of the part number. T/R tape reel - 500 pieces per reel
--

4SS-Series Ordering Scheme



1 SERIES 4SS Sealed Sub-Miniature Slide Switch												
2 POLES FSP single pole												
3 CIRCUIT Switching Position: <table style="width: 100%; border-collapse: collapse;"> <tr> <td style="width: 10%;"></td> <td style="width: 15%;"><i>2-1</i></td> <td style="width: 40%;"><i>OPEN</i></td> <td style="width: 15%;"><i>2-3</i></td> </tr> <tr> <td>1</td> <td>ON</td> <td>NONE</td> <td>ON</td> </tr> <tr> <td>3</td> <td>ON</td> <td>OFF</td> <td>ON</td> </tr> </table>		<i>2-1</i>	<i>OPEN</i>	<i>2-3</i>	1	ON	NONE	ON	3	ON	OFF	ON
	<i>2-1</i>	<i>OPEN</i>	<i>2-3</i>									
1	ON	NONE	ON									
3	ON	OFF	ON									
4 TERMINATION Termination options for switches with brick color actuators M2 PCB M6 PC Mount, 90° horizontal M7 PC Mount, 90° vertical Termination options for switches with white color actuators L6 Surface Mount, 90° flat S6 Surface Mount, 90° horizontal S7 Surface Mount, 90° vertical												

5 CONTACT			
	<i>Material</i>	<i>Terminal Plating</i>	<i>Rating</i>
G	silver ¹	gold over silver	3A@125VAC or 28VDC; 1.5A @ 250VAC
K	gold ²	tin-lead ⁴	0.4VA max. @20V max (AC/DC)
P	silver ¹	tin-lead	3A@125VAC or 28VDC; 1.5A @ 250VAC
R	gold ²	gold ²	0.4VA max. @20V max (AC/DC)
NOTE:			
Tin-lead option available with PC type terminations only.			
1 Moveable contact & terminals: copper alloy, silver plate			
2 Moveable contact & terminals: copper alloy with gold plate over nickel plate			
3 Terminals: silver plate with outer layer in gold plating			
4 Outer terminals: copper alloy with tin-lead over nickel plate			

6 EPOXY SEAL
E epoxy seal

7 PACKAGING
Switches are bulk packed, unless T/R is specified at the end of the part number.
T/R tape reel - 500 pieces per reel

4M1-Series Ordering Scheme

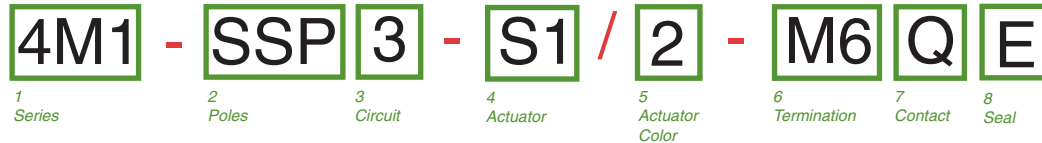

1 SERIES 4M1 Miniature Slide Switch												
2 POLES SSP single pole SDP double pole												
3 CIRCUIT Switching Position <table style="width: 100%; border-collapse: collapse;"> <tr> <td style="width: 10%;"></td> <td style="width: 15%;"><i>2-1, 5-4</i></td> <td style="width: 40%;"><i>OPEN</i></td> <td style="width: 15%;"><i>2-3, 5-6</i></td> </tr> <tr> <td>1</td> <td>ON</td> <td>NONE</td> <td>ON</td> </tr> <tr> <td>3</td> <td>ON</td> <td>OFF</td> <td>ON</td> </tr> </table>		<i>2-1, 5-4</i>	<i>OPEN</i>	<i>2-3, 5-6</i>	1	ON	NONE	ON	3	ON	OFF	ON
	<i>2-1, 5-4</i>	<i>OPEN</i>	<i>2-3, 5-6</i>									
1	ON	NONE	ON									
3	ON	OFF	ON									
4 ACTUATOR S1 .201 [5.10] high S2 .285 [7.25] high S3 .370 [9.40] high S4 .140 [3.55] high S5 .053 [1.35] high (for DPDT only) S6 .482 [12.25] high S7 .311 [7.90] high T1 .201 [5.10] high (for DPDT only)												
5 ACTUATOR COLOR¹ <table style="width: 100%; border-collapse: collapse;"> <tr> <td style="width: 25%;">1 white</td> <td style="width: 25%;">3 red</td> <td style="width: 25%;">5 yellow</td> <td style="width: 25%;">7 blue</td> </tr> <tr> <td>2 black</td> <td>4 orange</td> <td>6 green</td> <td>8 brown</td> </tr> </table> <p><small>1 White, black & red are standard. Other colors available for quantities of 5K or more.</small></p>	1 white	3 red	5 yellow	7 blue	2 black	4 orange	6 green	8 brown				
1 white	3 red	5 yellow	7 blue									
2 black	4 orange	6 green	8 brown									

6 TERMINATION	
M1 Solder Lug	M5-3 Wire Wrap [10.80]
M2 PCB	M5-4 Wire Wrap [26.97]
M3 Quick Connect	M6 PC Mount, 90° horizontal
M5-1 Wire Wrap .750 [19.05]	M7 PC Mount, 90° vertical
M5-2 Wire Wrap [24.48]	VS2 PC Mount, U bracket, .620 mounting x .460 high

7 CONTACT			
	<i>Material</i>	<i>Terminal Plating</i>	<i>Rating</i>
G	silver ¹	gold over silver ²	5A@125VAC or 28VDC; 2A @ 250VAC
K	gold ²	tin-lead ⁴	0.4VA max. @20V max (AC/DC)
P	silver ¹	tin-lead ⁴	5A@125VAC or 28VDC; 2A @ 250VAC
Q	silver ¹	silver ¹	5A@125VAC or 28VDC; 2A @ 250VAC
R	gold ²	gold ²	0.4VA max. @20V max (AC/DC)
NOTE:			
Tin-lead option available with PC type terminations only.			
1 Moveable contact & terminals: copper alloy, silver plate			
2 Moveable contact & terminals: copper alloy with gold plate over nickel plate			
3 Terminals: silver plate with outer layer in gold plating			
4 Outer terminals: copper alloy with tin-lead over nickel plate			

8 EPOXY SEAL
E epoxy seal

4S-Series Dimensional Specifications: in. [mm]

4S1-Series

TERMINATION

PC MOUNTING

M2

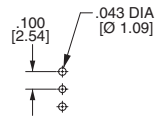
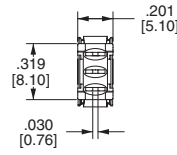
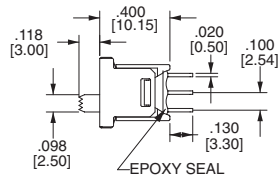
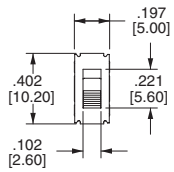

M6

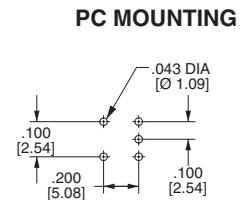
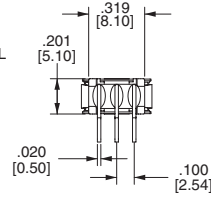
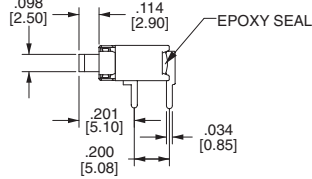
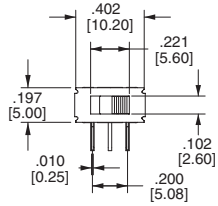

4SS-Series

TERMINATION

PC MOUNTING

M2

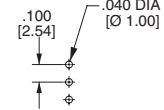
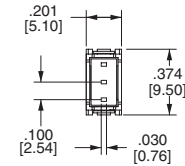
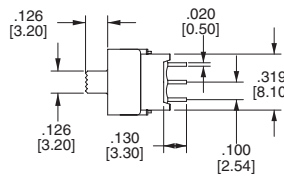
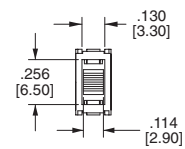

M6

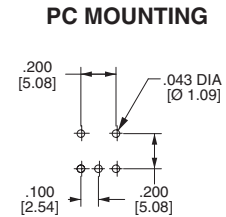
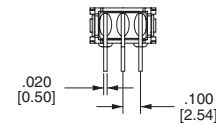
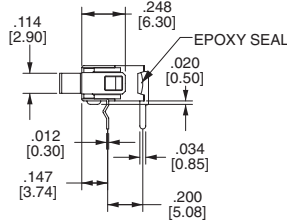
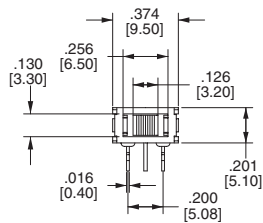

M7

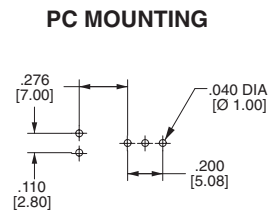
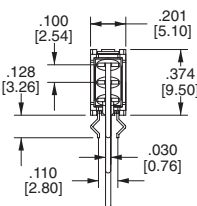
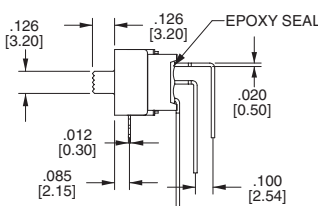
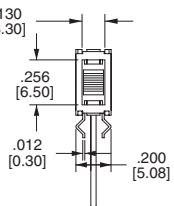

L6

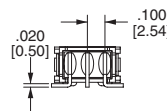
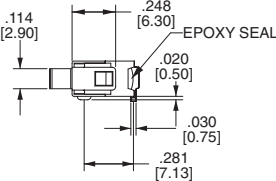
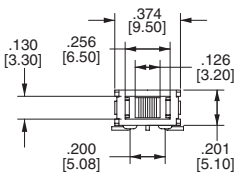

PC MOUNTING

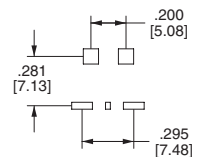

4SS-Series Dimensional Specifications: in. [mm]

TERMINATION

S6

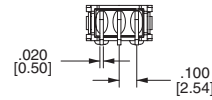
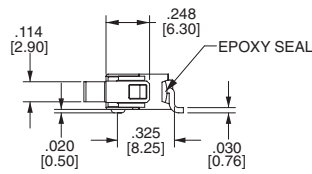
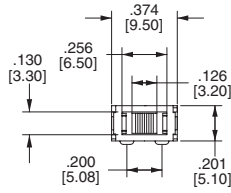

PC MOUNTING

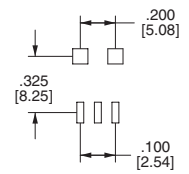

S7

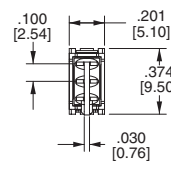
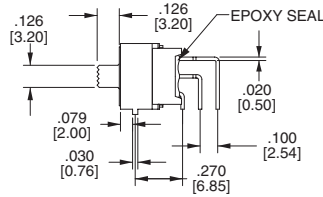
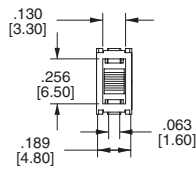

PC MOUNTING

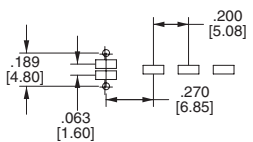

REEL TAPING

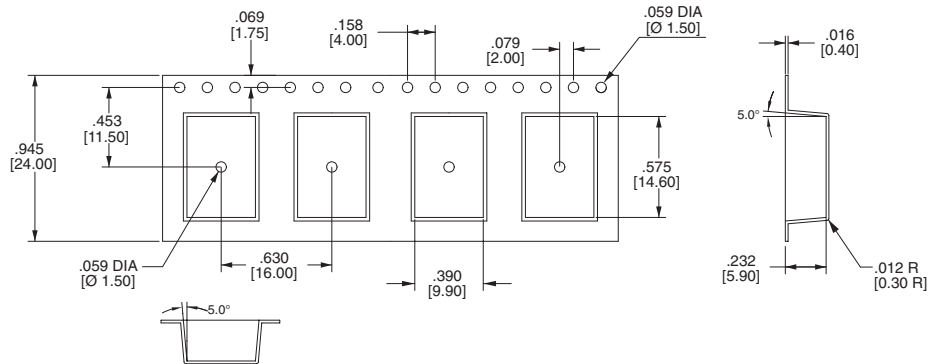

FOR S6, L6 ONLY

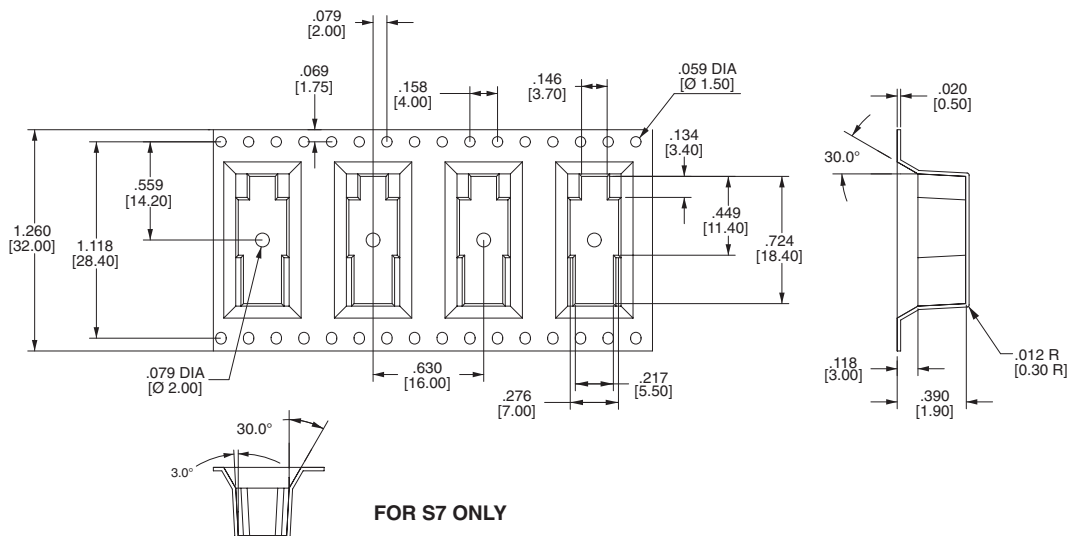

FOR S7 ONLY

4M1-Series Dimensional Specifications: in. [mm]

ACTUATOR

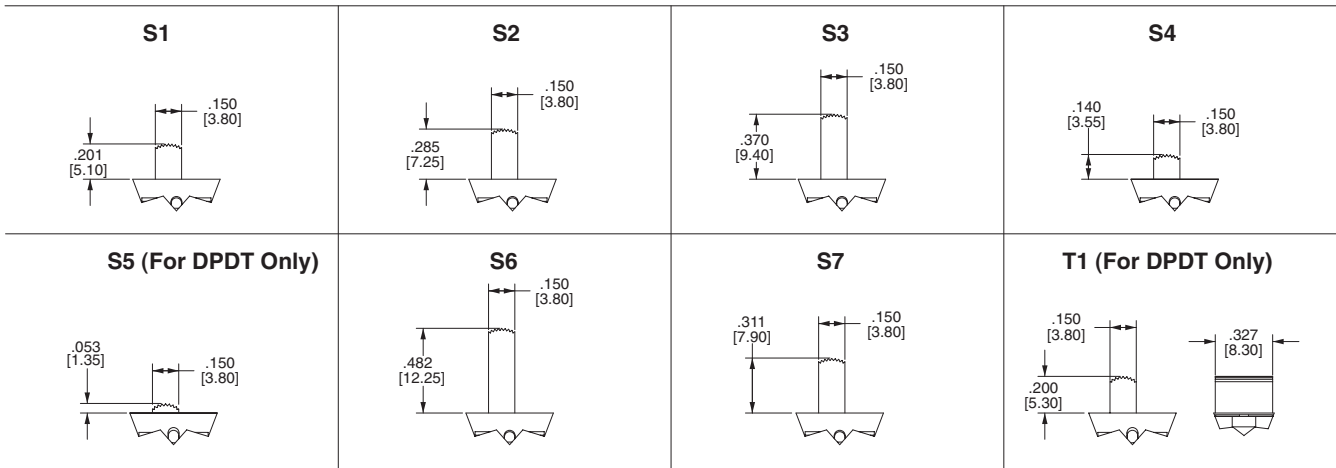

TERMINATION

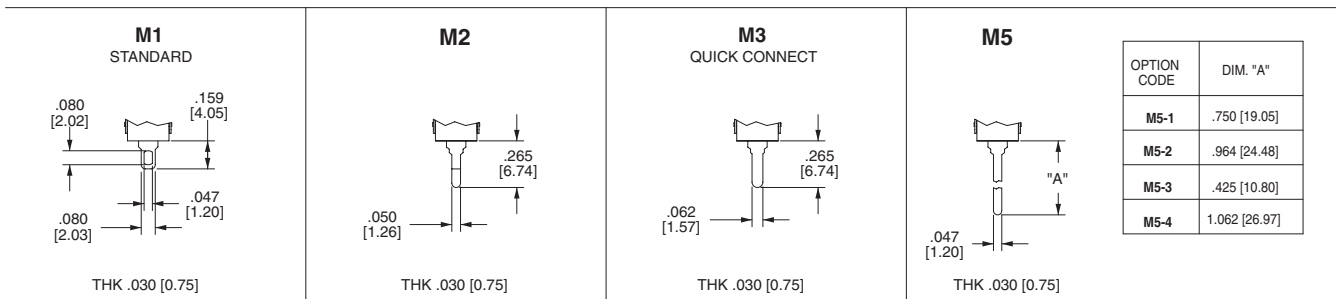

SINGLE POLE

DOUBLE POLE

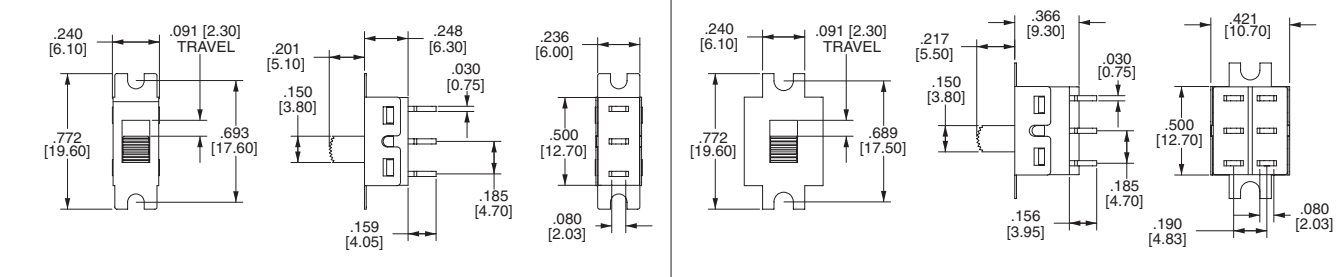

M6

SINGLE POLE

PC MOUNTING

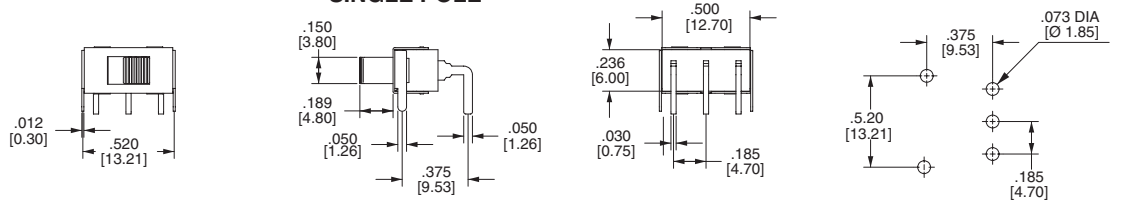

DOUBLE POLE

PC MOUNTING

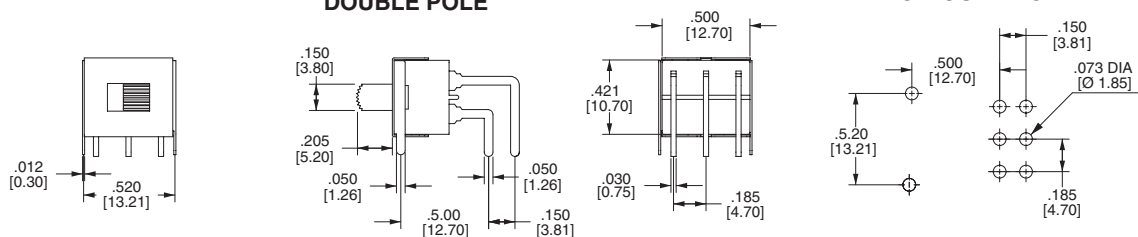

4M1-Series Dimensional Specifications: in. [mm]

TERMINATION

M7

SINGLE POLE

PC MOUNTING

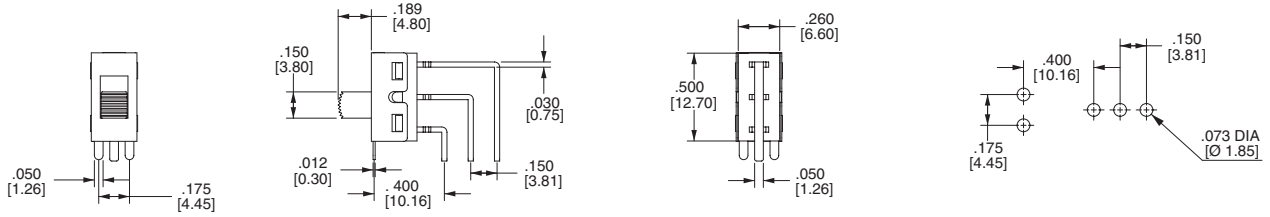

DOUBLE POLE

PC MOUNTING

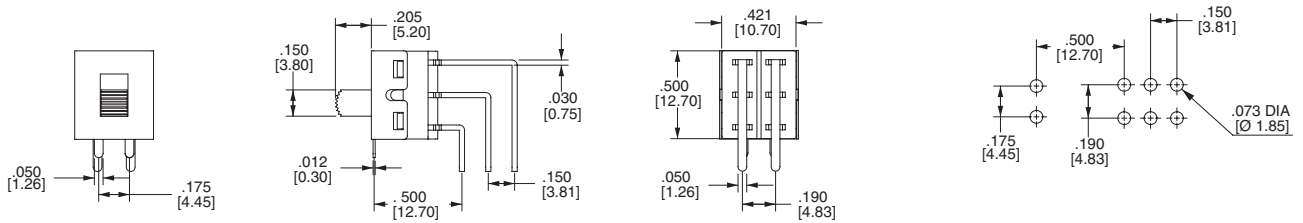

VS2

SINGLE POLE

PC MOUNTING

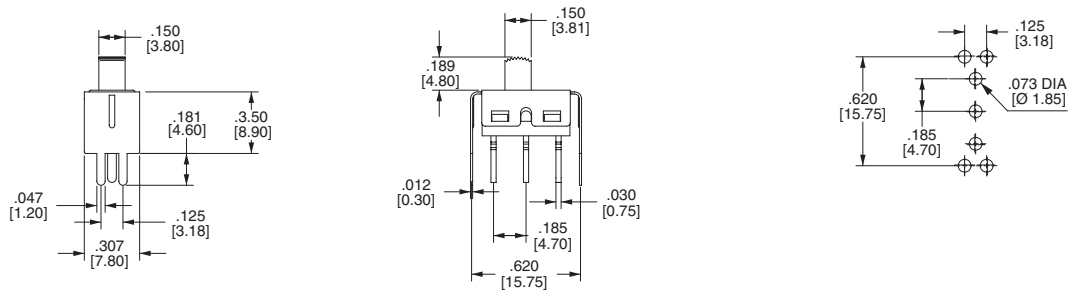

DOUBLE POLE

PC MOUNTING

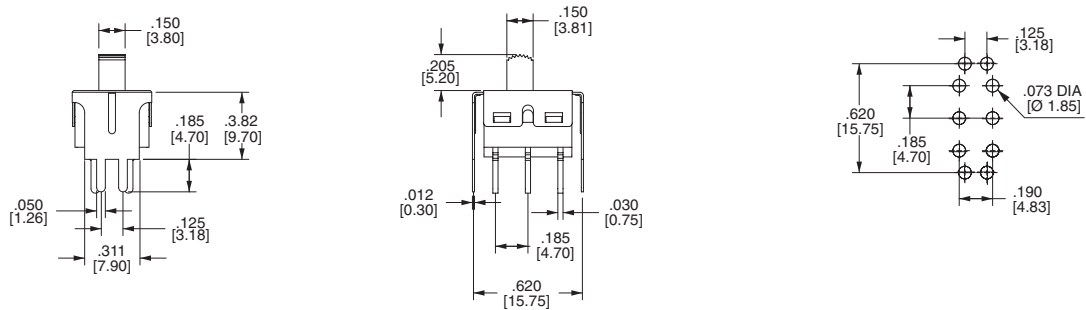

Компания «Life Electronics» занимается поставками электронных компонентов импортного и отечественного производства от производителей и со складов крупных дистрибьюторов Европы, Америки и Азии.

С конца 2013 года компания активно расширяет линейку поставок компонентов по направлению коаксиальный кабель, кварцевые генераторы и конденсаторы (керамические, пленочные, электролитические), за счёт заключения дистрибьюторских договоров

Мы предлагаем:

- Конкуренспособные цены и скидки постоянным клиентам.
- Специальные условия для постоянных клиентов.
- Подбор аналогов.
- Поставку компонентов в любых объемах, удовлетворяющих вашим потребностям.
- Приемлемые сроки поставки, возможна ускоренная поставка.
- Доставку товара в любую точку России и стран СНГ.
- Комплексную поставку.
- Работу по проектам и поставку образцов.
- Формирование склада под заказчика.
- Сертификаты соответствия на поставляемую продукцию (по желанию клиента).
- Тестирование поставляемой продукции.
- Поставку компонентов, требующих военную и космическую приемку.
- Входной контроль качества.
- Наличие сертификата ISO.

В составе нашей компании организован Конструкторский отдел, призванный помогать разработчикам, и инженерам.

Конструкторский отдел помогает осуществить:

- Регистрацию проекта у производителя компонентов.
- Техническую поддержку проекта.
- Защиту от снятия компонента с производства.
- Оценку стоимости проекта по компонентам.
- Изготовление тестовой платы монтаж и пусконаладочные работы.



Тел: +7 (812) 336 43 04 (многоканальный)

Email: org@lifeelectronics.ru