

RF360 Europe GmbH  
A Qualcomm – TDK Joint Venture

## SAW components

SAW RF filter  
Digital radio

Series/type:	B1669
Ordering code:	B39232B1669U410
Date:	July 02, 2017
Version:	2.6

RF360 products mentioned within this document are offered by RF360 Europe GmbH and other subsidiaries of RF360 Holdings Singapore Pte. Ltd. (collectively, the “RF360 Subsidiaries”).

RF360 Holdings Singapore Pte. Ltd. is a joint venture of Qualcomm Global Trading Pte. Ltd. and EPCOS AG.

RF360 Europe GmbH, Anzinger Str. 13, München, Germany

© 2017 RF360 Europe GmbH and/or its affiliated companies. All rights reserved.

**SAW components****B1669****SAW RF filter****2332.5 MHz**

Data sheet

These materials, including the information contained herein, may be used only for informational purposes by the customer. The RF360 Subsidiaries assume no responsibility for errors or omissions in these materials or the information contained herein. The RF360 Subsidiaries reserve the right to make changes to the product(s) or information contained herein without notice. The materials and information are provided on an AS IS basis, and the RF360 Subsidiaries assume no liability and make no warranty or representation, either expressed or implied, with respect to the materials, or any output or results based on the use, application, or evaluation of such materials, including, without limitation, with respect to the non-infringement of trademarks, patents, copyrights or any other intellectual property rights or other rights of third parties.

No use of this documentation or any information contained herein grants any license, whether express, implied, by estoppel or otherwise, to any intellectual property rights, including, without limitation, to any patents owned by QUALCOMM Incorporated or any of its subsidiaries.

Not to be used, copied, reproduced, or modified in whole or in part, nor its contents revealed in any manner to others without the express written permission of RF360 Europe GmbH.

Qualcomm and Qualcomm RF360 are trademarks of Qualcomm Incorporated, registered in the United States and other countries. RF360 is a trademark of Qualcomm Incorporated. Other product and brand names may be trademarks or registered trademarks of their respective owners.

This technical data may be subject to U.S. and international export, re-export, or transfer ("export") laws. Diversion contrary to U.S. and international law is strictly prohibited.

<b>SAW components</b>	<b>B1669</b>
<b>SAW RF filter</b>	<b>2332.5 MHz</b>

Data sheet

**Table of contents**

1 <a href="#">Application</a> .....	4
2 <a href="#">Features</a> .....	4
3 <a href="#">Package</a> .....	5
4 <a href="#">Pin configuration</a> .....	5
5 <a href="#">Matching circuit</a> .....	6
6 <a href="#">Characteristics</a> .....	7
7 <a href="#">Maximum ratings</a> .....	8
8 <a href="#">Transmission coefficient</a> .....	9
9 <a href="#">Group delay</a> .....	10
10 <a href="#">Packing material</a> .....	11
11 <a href="#">Marking</a> .....	13
12 <a href="#">Soldering profile</a> .....	14
13 <a href="#">ESD protection of SAW filters</a> .....	15
14 <a href="#">Annotations</a> .....	16
15 <a href="#">Cautions and warnings</a> .....	17
<a href="#">Important notes</a> .....	18

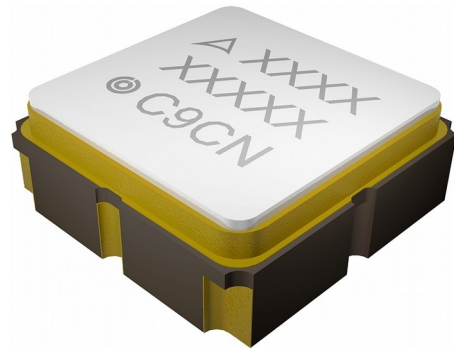
Data sheet

## 1 Application

- Low-loss RF filter for digital radio
- Low amplitude ripple
- Usable pass band 25.0 MHz

## 2 Features

- Package size  $3.0\pm 0.1$  mm  $\times$   $3.0\pm 0.1$  mm
- Package height  $1.1\pm 0.125$  mm
- Package code DCC6C
- Approximate weight 0.04 g
- RoHS compatible
- Package for Surface Mount Technology (SMT)
- Ni/Au-plated terminals
- Lead free soldering compatible with J-STD20C
- Filter surface passivated
- Electrostatic Sensitive Device (ESD)
- Moisture Sensitivity Level 1 (MSL1)
- AEC-Q200 qualified component family  
(Grade 1:  $-40$  °C to  $+125$  °C)



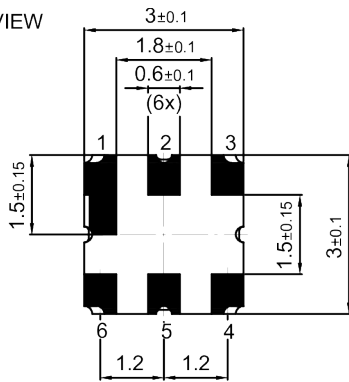
**Figure 1:** Picture of component with example of product marking.

**SAW components** **B1669**  
**SAW RF filter** **2332.5 MHz**

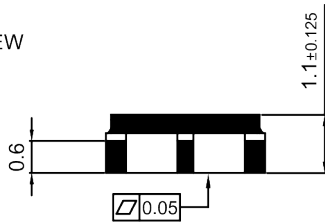
Data sheet

**3 Package**

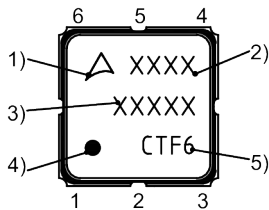
BOTTOM VIEW



SIDE VIEW



TOP VIEW

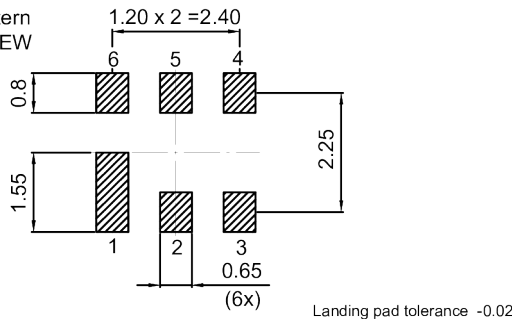


SIDE VIEW



- 1) Company logo
- 2) Device designation
- 3) Last five digits of the lot number
- 4) Marking for pad number 1
- 5) Example of production location and date code

Land pattern THRU VIEW



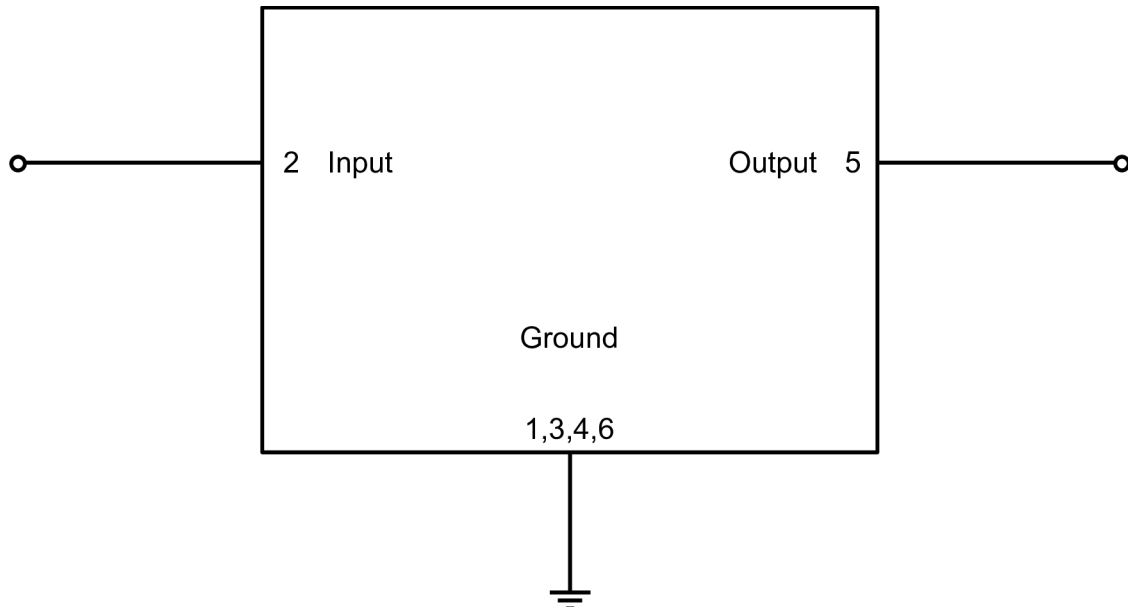
**Figure 2:** Drawing of package. See Sec. Package information (p. 17).

**4 Pin configuration**

- 2            Input
- 5            Output
- 1, 3, 4, 6    Ground

Data sheet

## 5 Matching circuit



**Figure 3:** Schematic of matching circuit. No external matching components required.

## SAW components

B1669

## SAW RF filter

2332.5 MHz

Data sheet

## 6 Characteristics

Temperature range for specification	$T_{SPEC}$	= -45 °C ... +105 °C
Input terminating impedance	$Z_{IN}$	= 50 $\Omega$
Output terminating impedance	$Z_{OUT}$	= 50 $\Omega$

Characteristics			min. for $T_{SPEC}$	typ. @ +25 °C	max. for $T_{SPEC}$		
<b>Center frequency</b>		$f_C$	—	2332.5	—	MHz	
<b>Maximum insertion attenuation</b>	2320... 2345	MHz	$\alpha_{max}$	—	2.4	2.8	dB
<b>Amplitude ripple (p-p)</b>	2320... 2345	MHz	$\Delta\alpha$	—	0.6	1.0	dB
<b>Maximum VSWR</b>			$VSWR_{max}$				
@ input port	2320... 2345	MHz		—	1.6	2.0	
@ output port	2320... 2345	MHz		—	1.6	2.0	
<b>Minimum attenuation</b>			$\alpha_{min}$				
	50... 2120	MHz		40	47	—	dB
	2560... 3000	MHz		36	40	—	dB
	3000... 3500	MHz		33	37	—	dB
	3500... 4000	MHz		30	34	—	dB
	4000... 5000	MHz		20	26	—	dB
<b>Group delay ripple</b>			$\Delta\tau_{var}$				
	2320... 2345	MHz		—	5.0	15	ns

## SAW components

B1669

## SAW RF filter

2332.5 MHz

Data sheet

## 7 Maximum ratings

Operable temperature	$T_{OP} = -45\text{ °C} \dots +125\text{ °C}$	
Storage temperature	$T_{STG}^{1)} = -45\text{ °C} \dots +125\text{ °C}$	
DC voltage	$ V_{DC}  = 6.0\text{ V}$	
ESD voltage	$V_{ESD}^{2)} = 50\text{ V}$	Machine model.
Input power	$P_{IN}$	
@ input port: 700 ... 2170 MHz	20 dBm	
@ input port: 2320 ... 2345 MHz	10 dBm	
@ input port: 2500 ... 3000 MHz	20 dBm	

<sup>1)</sup> Not valid for packaging material. Storage temperature for packaging material is  $-25\text{ °C}$  to  $+40\text{ °C}$ .

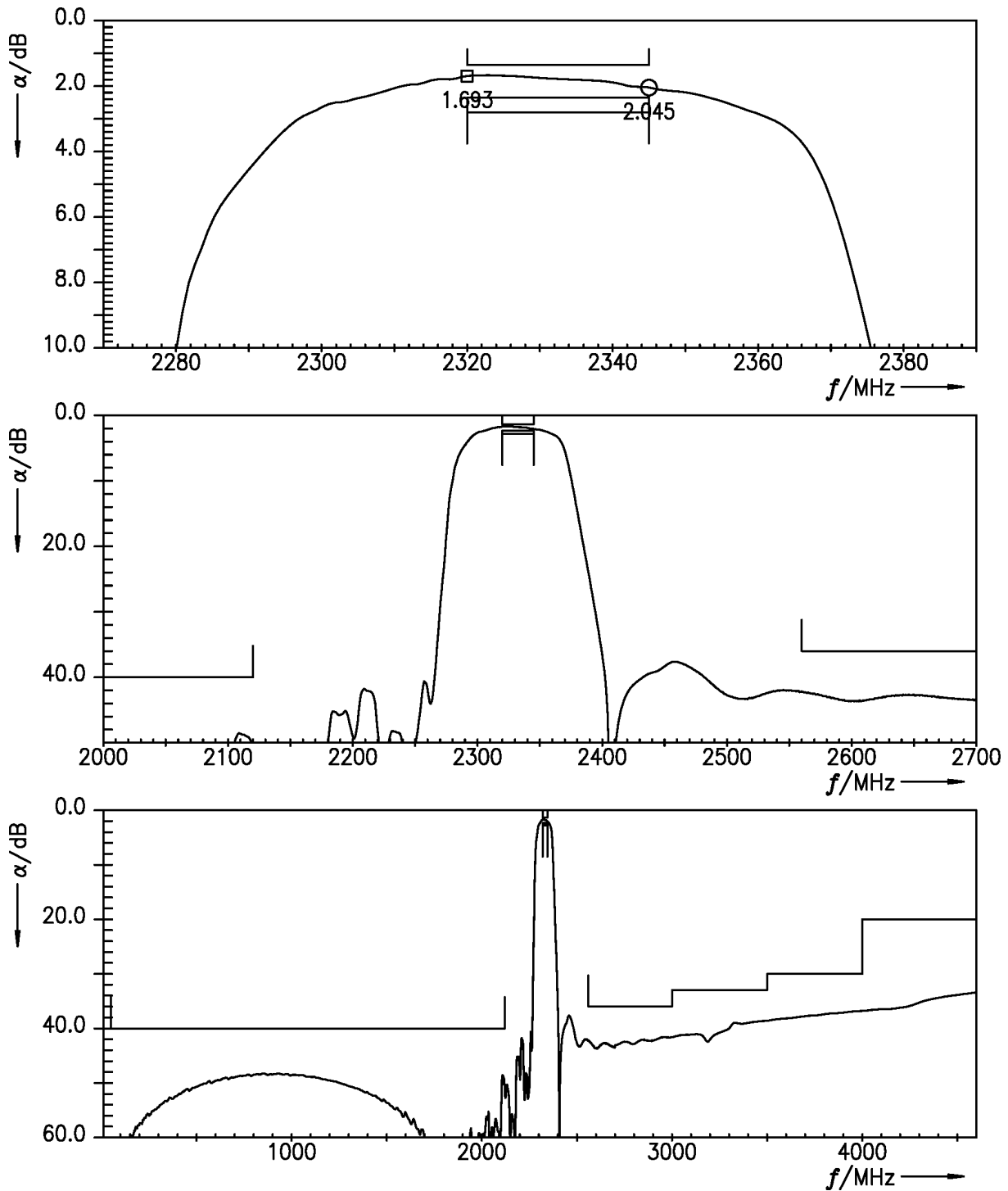
<sup>2)</sup> According to JESD22-A115B (MM – Machine Model), 10 negative & 10 positive pulses.



<b>SAW components</b>	<b>B1669</b>
<b>SAW RF filter</b>	<b>2332.5 MHz</b>

Data sheet

**8 Transmission coefficient**



**Figure 4:** Attenuation.

SAW components	B1669
SAW RF filter	2332.5 MHz

Data sheet

9 Group delay

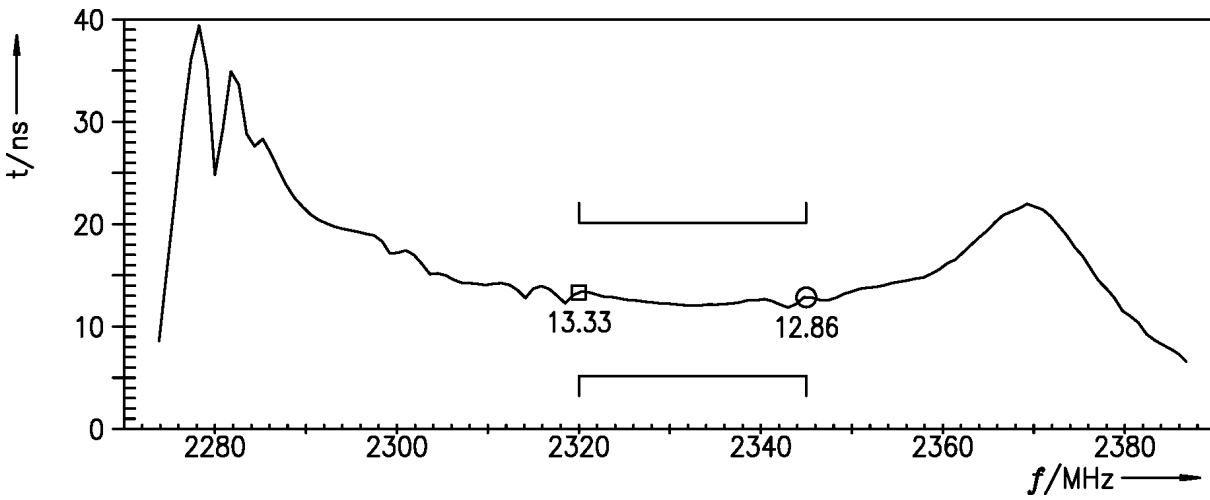


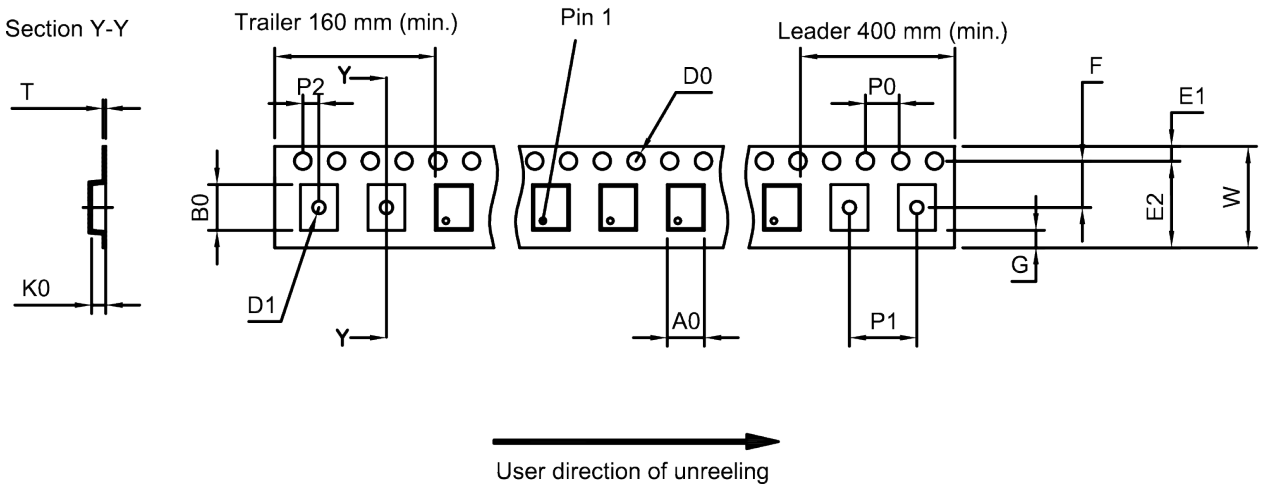
Figure 5: Group delay ripple.

**SAW components** **B1669**  
**SAW RF filter** **2332.5 MHz**

Data sheet

**10 Packing material**

**10.1 Tape**



**Figure 6:** Drawing of tape (first-angle projection) with tape dimensions according to Table 1.

A <sub>0</sub>	3.25±0.1 mm	E <sub>2</sub>	10.25 mm (min.)	P <sub>1</sub>	4.0±0.1 mm
B <sub>0</sub>	3.3±0.1 mm	F	5.5±0.05 mm	P <sub>2</sub>	2.0±0.1 mm
D <sub>0</sub>	1.5+0.1/-0 mm	G	0.75 mm (min.)	T	0.2±0.05 mm
D <sub>1</sub>	1.5 mm (min.)	K <sub>0</sub>	1.5±0.1 mm	W	12.0+0.3/-0.1 mm
E <sub>1</sub>	1.75±0.1 mm	P <sub>0</sub>	4.0±0.1 mm		

**Table 1:** Tape dimensions.

SAW components	B1669
SAW RF filter	2332.5 MHz

Data sheet

10.2 Reel with diameter of 330 mm

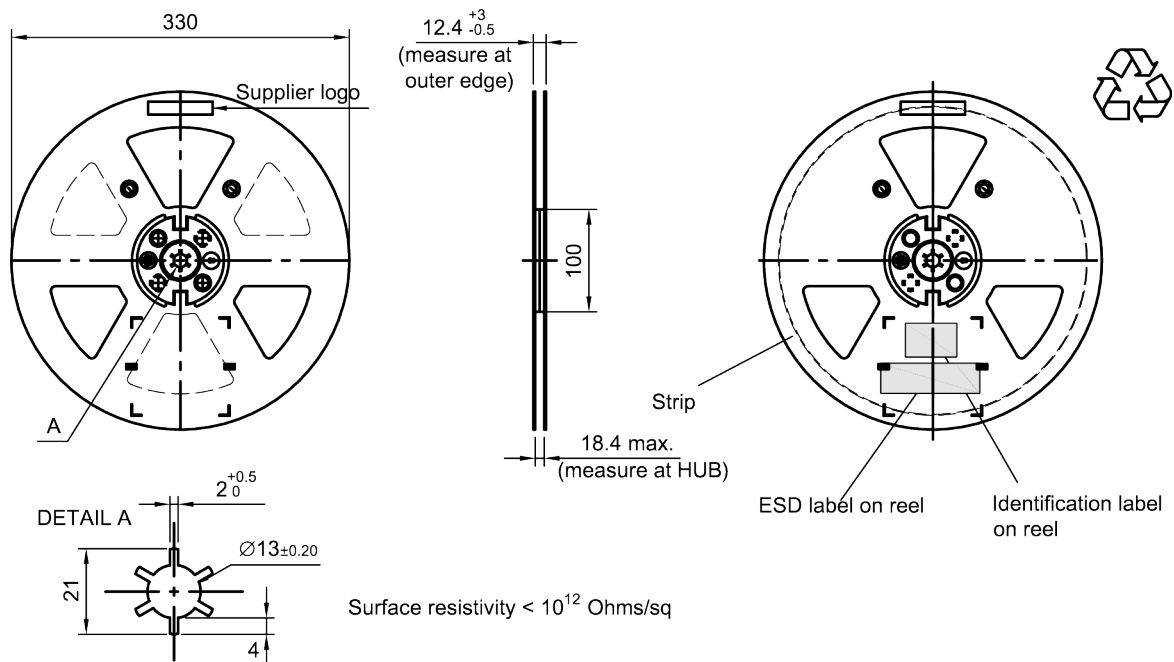
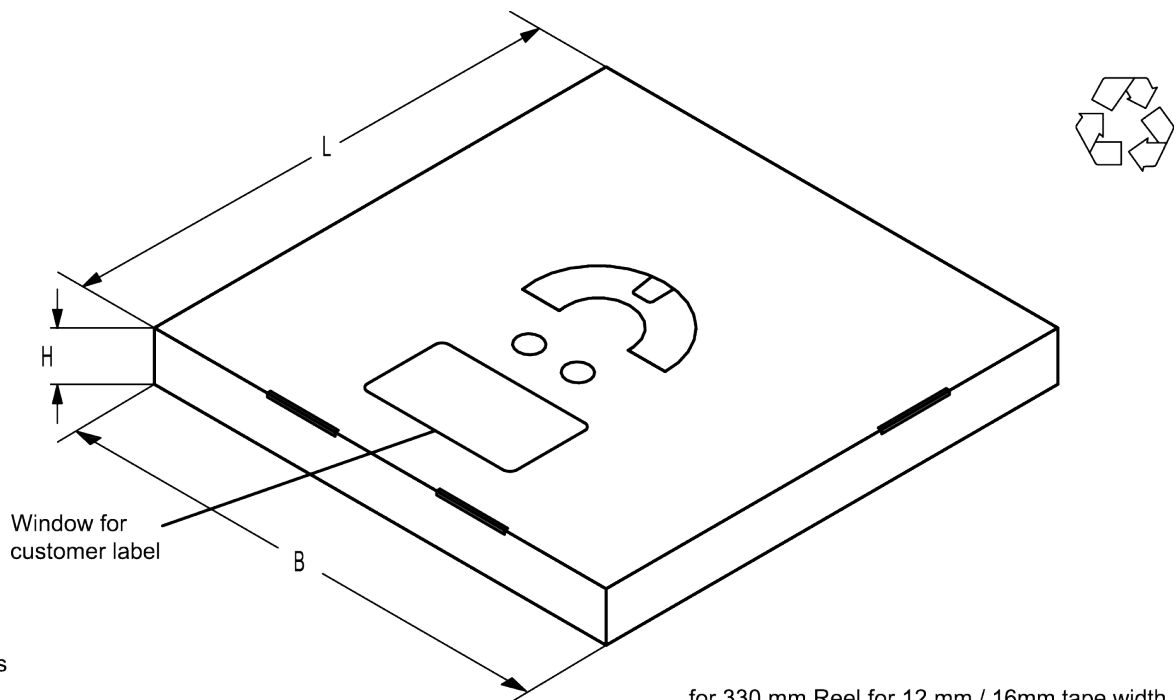


Figure 7: Drawing of reel (first-angle projection) with diameter of 330 mm.



Dimensions

- L = 340
- B = 340
- H = 25

for 330 mm Reel for 12 mm / 16mm tape width SMD packages

Figure 8: Drawing of folding box for reel with diameter of 330 mm.

## SAW components

B1669

## SAW RF filter

2332.5 MHz

Data sheet

## 11 Marking

Products are marked with device designation, lot number, as well as production location and date code.

- Device designation: The 4-character device designation of the ordering code is used for the marking.

Example for 4-character device designation: B3xxxxB1234xxxx

- Lot number: The last 5 digits of the lot number are used for the marking.

Example: 12345

- Production location and date code: The production location is Wuxi (encoded in the first character 'C'). The production date code is encoded in the last three characters according to Table 2.

1 <sup>st</sup> digit (day)						2 <sup>nd</sup> digit (year)				3 <sup>rd</sup> digit (month)			
Day	Code	Day	Code	Day	Code	Year	Code	Year	Code	Month	Code	Month	Code
1	1	11	A	21	M	2010	A	2022	P	Jan	1	Jul	7
2	2	12	B	22	N	2011	B	2023	R	Feb	2	Aug	8
3	3	13	C	23	P	2012	C	2024	S	Mar	3	Sep	9
4	4	14	D	24	R	2013	D	2025	T	Apr	4	Oct	0
5	5	15	E	25	S	2014	E	2026	U	May	5	Nov	N
6	6	16	F	26	T	2015	F	2027	V	Jun	6	Dec	D
7	7	17	H	27	U	2016	H	2028	W				
8	8	18	J	28	V	2017	J	2029	X				
9	9	19	K	29	W	2018	K	2030	Z				
10	0	20	L	30	X	2019	L	2031	A				
				31	Z	2020	M	2032	B				
						2021	N	and so on					

**Table 2:** Production date code.

Example of how to decode production location and date code:

Code:           **C T F 6**

Location:       **C**       → Wuxi

Day:            **T**       → 26<sup>th</sup>

Year:           **F**       → 2015

Month:          **6**       → June

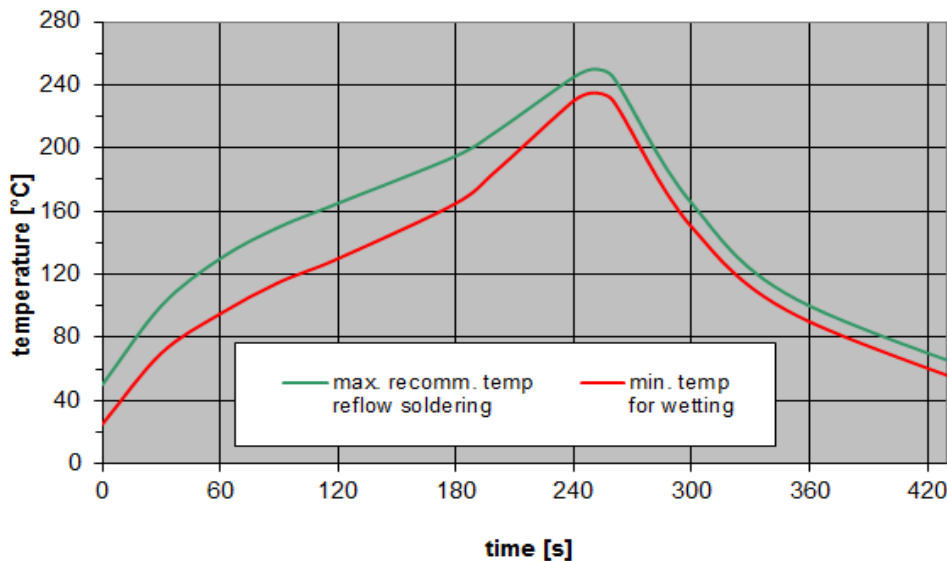
Data sheet

## 12 Soldering profile

The recommended soldering process is in accordance with IEC 60068-2-58 – 3<sup>rd</sup> edit and IPC/JEDEC J-STD-020B.

ramp rate	≤ 3 K/s
preheat	125 °C to 220 °C, 150 s to 210 s, 0.4 K/s to 1.0 K/s
$T > 220$ °C	30 s to 70 s
$T > 230$ °C	min. 10 s
$T > 245$ °C	max. 20 s
$T \geq 255$ °C	–
peak temperature $T_{\text{peak}}$	250 °C +0/-5 °C
wetting temperature $T_{\text{min}}$	230 °C +5/-0 °C for 10 s ± 1 s
cooling rate	≤ 3 K/s
soldering temperature $T$	measured at solder pads

**Table 3:** Characteristics of recommended soldering profile for lead-free solder (Sn95.5Ag3.8Cu0.7).



**Figure 9:** Recommended reflow profile for convection and infrared soldering – lead-free solder.

Data sheet

### 13 ESD protection of SAW filters

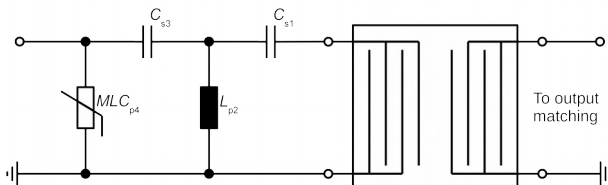
SAW filters are **E**lectro **S**tatic **D**ischarge sensitive devices. To reduce the probability of damages caused by ESD, special matching topologies have to be applied.

In general, “ESD matching” has to be ensured at that filter port, where electrostatic discharge is expected.

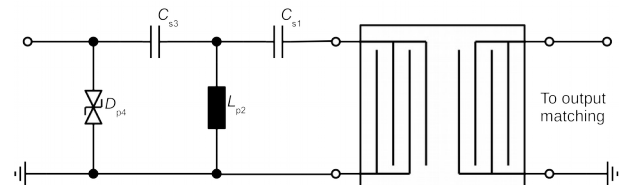
Electrostatic discharges predominantly appear at the antenna input of RF receivers. Therefore, only the input matching of the SAW filter has to be designed to short circuit or to block the ESD pulse.

Below three figures show recommended “ESD matching” topologies.

For wide band filters the high-pass ESD matching structure needs to be at least of 3<sup>rd</sup> order to ensure a proper matching for any impedance value of antenna and SAW filter input. The required component values have to be determined from case to case.

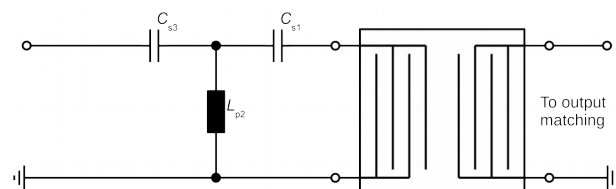


**Figure 10:** MLC varistor plus ESD matching.



**Figure 11:** Suppressor diode plus ESD matching.

In cases where minor ESD occur, following simplified “ESD matching” topologies can be used alternatively.



**Figure 12:** 3<sup>rd</sup> order high-pass structure for basic ESD protection.

In all three figures the shunt inductor  $L_{p2}$  could be replaced by a shorted microstrip with proper length and width. If this configuration is possible depends on the operating frequency and available PCB space.

Effectiveness of the applied ESD protection has to be checked according to relevant industry standards or customer specific requirements.

For further information, please refer to RF360 Application report: “**ESD protection for SAW filters**”. This report can be found under [www.rf360jv.com/rke](http://www.rf360jv.com/rke). Click on “Applications Notes”.

<b>SAW components</b>	<b>B1669</b>
<b>SAW RF filter</b>	<b>2332.5 MHz</b>

Data sheet

## 14 Annotations

### 14.1 Matching coils

See TDK inductor pdf-catalog <http://www.tdk.co.jp/tefe02/coil.htm#aname1> and Data Library for circuit simulation <http://www.tdk.co.jp/etvcl/index.htm>.

### 14.2 RoHS compatibility

ROHS-compatible means that products are compatible with the requirements according to Art. 4 (substance restrictions) of Directive 2011/65/EU of the European Parliament and of the Council of June 8th, 2011, on the restriction of the use of certain hazardous substances in electrical and electronic equipment ("Directive") with due regard to the application of exemptions as per Annex III of the Directive in certain cases.

### 14.3 Scattering parameters (S-parameters)

The pin/port assignment is available in the headers of the S-parameter files. Please contact your local RF360 sales office.



Data sheet

## 15 Cautions and warnings

### 15.1 Display of ordering codes for RF360 products

The ordering code for one and the same product can be represented differently in data sheets, data books, other publications and the website of RF360, or in order-related documents such as shipping notes, order confirmations and product labels. The varying representations of the ordering codes are due to different processes employed and do not affect the specifications of the respective products. Detailed information can be found on the Internet under [www.rf360jv.com/orderingcodes](http://www.rf360jv.com/orderingcodes).

### 15.2 Material information

Due to technical requirements components may contain dangerous substances. For information on the type in question please also contact one of our sales offices.

For information on recycling of tapes and reels please contact one of our sales offices.

### 15.3 Moldability

Before using in overmolding environment, please contact your local RF360 sales office.

### 15.4 Package information

#### Landing area

The printed circuit board (PCB) land pattern (landing area) shown is based on RF360 internal development and empirical data and illustrated for example purposes, only. As customers' SMD assembly processes may have a plenty of variants and influence factors which are not under control or knowledge of RF360, additional careful process development on customer side is necessary and strongly recommended in order to achieve best soldering results tailored to the particular customer needs.

#### Dimensions

Unless otherwise specified all dimensions are understood using unit millimeter (mm).

#### Projection method

Unless otherwise specified first-angle projection is applied.

## Important notes

The following applies to all products named in this publication:

1. Some parts of this publication contain **statements about the suitability of our products for certain areas of application**. These statements are based on our knowledge of typical requirements that are often placed on our products in the areas of application concerned. We nevertheless expressly point out **that such statements cannot be regarded as binding statements about the suitability of our products for a particular customer application**. As a rule, RF360 Europe GmbH and its affiliates are either unfamiliar with individual customer applications or less familiar with them than the customers themselves. For these reasons, it is always ultimately incumbent on the customer to check and decide whether an RF360 product with the properties described in the product specification is suitable for use in a particular customer application.
2. We also point out that **in individual cases, a malfunction of electronic components or failure before the end of their usual service life cannot be completely ruled out in the current state of the art, even if they are operated as specified**. In customer applications requiring a very high level of operational safety and especially in customer applications in which the malfunction or failure of an electronic component could endanger human life or health (e.g. in accident prevention or life-saving systems), it must therefore be ensured by means of suitable design of the customer application or other action taken by the customer (e.g. installation of protective circuitry or redundancy) that no injury or damage is sustained by third parties in the event of malfunction or failure of an electronic component.
3. **The warnings, cautions and product-specific notes must be observed.**
4. In order to satisfy certain technical requirements, **some of the products described in this publication may contain substances subject to restrictions in certain jurisdictions (e.g. because they are classed as hazardous)**. Useful information on this will be found in our Material Data Sheets on the Internet ([www.rf360jv.com/material](http://www.rf360jv.com/material)). Should you have any more detailed questions, please contact our sales offices.
5. We constantly strive to improve our products. Consequently, **the products described in this publication may change from time to time**. The same is true of the corresponding product specifications. Please check therefore to what extent product descriptions and specifications contained in this publication are still applicable before or when you place an order. We also **reserve the right to discontinue production and delivery of products**. Consequently, we cannot guarantee that all products named in this publication will always be available.  
The aforementioned does not apply in the case of individual agreements deviating from the foregoing for customer-specific products.

Компания «Life Electronics» занимается поставками электронных компонентов импортного и отечественного производства от производителей и со складов крупных дистрибьюторов Европы, Америки и Азии.

С конца 2013 года компания активно расширяет линейку поставок компонентов по направлению коаксиальный кабель, кварцевые генераторы и конденсаторы (керамические, пленочные, электролитические), за счёт заключения дистрибьюторских договоров

Мы предлагаем:

- Конкурентоспособные цены и скидки постоянным клиентам.
- Специальные условия для постоянных клиентов.
- Подбор аналогов.
- Поставку компонентов в любых объемах, удовлетворяющих вашим потребностям.
- Приемлемые сроки поставки, возможна ускоренная поставка.
- Доставку товара в любую точку России и стран СНГ.
- Комплексную поставку.
- Работу по проектам и поставку образцов.
- Формирование склада под заказчика.
- Сертификаты соответствия на поставляемую продукцию (по желанию клиента).
- Тестирование поставляемой продукции.
- Поставку компонентов, требующих военную и космическую приемку.
- Входной контроль качества.
- Наличие сертификата ISO.

В составе нашей компании организован Конструкторский отдел, призванный помогать разработчикам, и инженерам.

Конструкторский отдел помогает осуществить:

- Регистрацию проекта у производителя компонентов.
- Техническую поддержку проекта.
- Защиту от снятия компонента с производства.
- Оценку стоимости проекта по компонентам.
- Изготовление тестовой платы монтаж и пусконаладочные работы.



Тел: +7 (812) 336 43 04 (многоканальный)

Email: [org@lifeelectronics.ru](mailto:org@lifeelectronics.ru)