

EC20A RK203

20mm Size Metal Shaft Type

Heavy torque and comfortable operation feel for encoder and potentiometer applications



Typical Specifications

Items	Specifications	
	Encoder	Potentiometer
Rating	1mA 5V DC	0.05W
Operating life	30,000 cycles	
Operating temperature range	-30°C to +80°C	-40°C to +85°C

Product Line Encoders

Shaft configuration	Length of the shaft (mm)	Detent torque (mN·m)	Number of detent	Number of pulse	Operating direction	Push-on switch	Travel of push-on switch (mm)	Minimum order unit (pcs.)		Product No.	Drawing No.
								Japan	Export		
Flat	30	40±20	18	18	Vertical	With	1.5	400	800	EC20A1824401	1
						Without	—			EC20A1820401	2
		25±10		EC20A1820407							

Potentiometer

Shaft configuration	Length of the shaft (mm)	Detent torque (mN·m)	Number of detent	Rotational angle	Operating direction	Number of resistor elements	Total resistance (kΩ)	Resistance taper	Minimum order unit (pcs.)		Product No.	Drawing No.
									Japan	Export		
Flat	30	40±20	17	220°	Vertical	Single-unit	10	1B	400	800	RK203111000V	3
			5	180°							RK203111001A	
			1⇔2position 40±20 2⇔18position 20±10	18							1⇔2position 25° 2⇔18position 180°	

Notes

1. Only the encoder type can be supplied with a push-on switch.
2. Shaft design and other features are customizable.

Packing Specifications

Tray

Number of packages (pcs.)		Export package measurements (mm)
1 case /Japan	1 case /export packing	
400	800	508×374×272



Dimensions

No.	Photo	Style	PC board mounting hole dimensions (Viewed from mounting side)
1	EC20A with push-on switch (travel 1.5mm) Encoder type 		

Refer to P.275 for attached parts.
Refer to P.275 for switch specifications.
Refer to P.299 for soldering conditions.

Dimensions

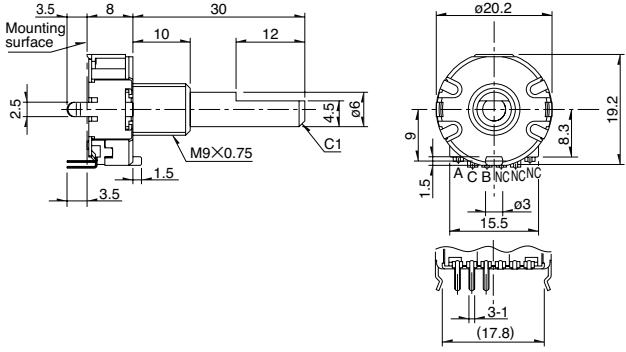
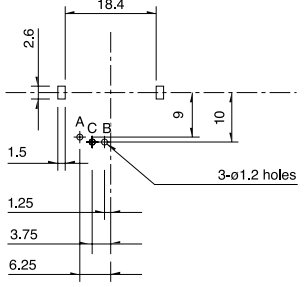
Unit:mm

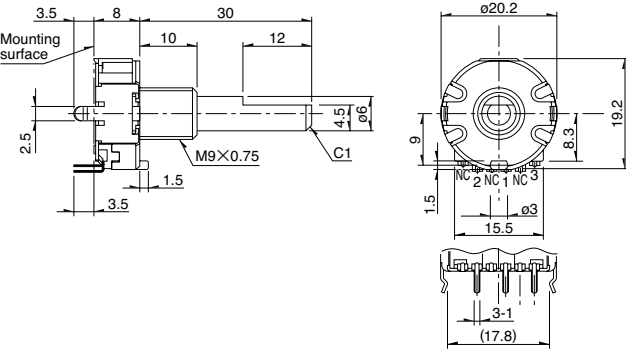
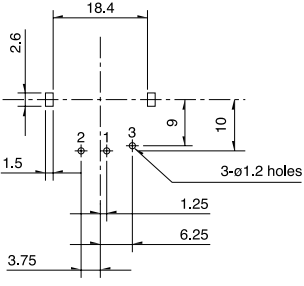
No.	Photo	Style	PC board mounting hole dimensions (View from mounting side)
2			
3			

Output Wave (EC20A)

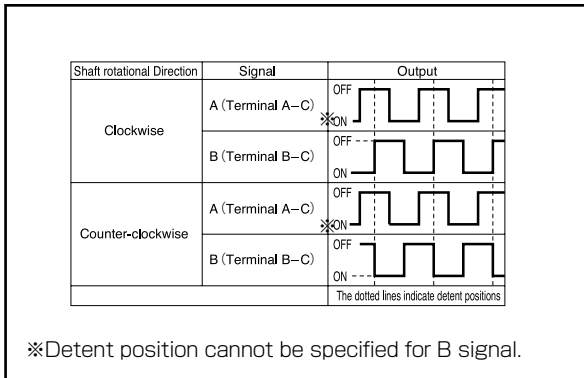

Output Wave (EC20A)

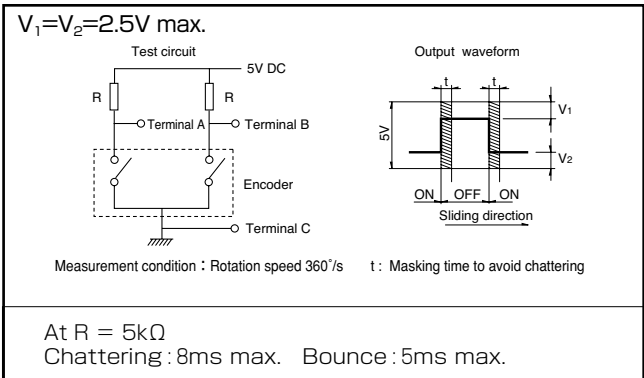

■ Circuit Diagram (RK203)

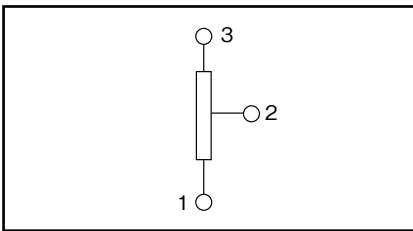

20mm Size Metal Shaft Type / Attached Parts









The following parts are included with the product

		Unit:mm
Nut		Washer

20mm Size Metal Shaft Encoder Type / Switch Specifications

The attachment switch is applied only for the encoder type.

Switch type		Momentary push switch
Contact arrangement		Single pole and single throw (Push-on)
Travel (mm)		1.5±0.5
Operating force		4±2N
Operating life		20,000 times
Electrical performance	Rating	0.1A 5V DC (0.1mA 5V DC min. ratings)
	Contact resistance	100mΩ max. for initial period, 200mΩ max. after operating life.
	Insulation resistance	10MΩ min. 50V DC
	Voltage proof	50V AC for 1 minute or 60V AC for 2 second

Type		Metal shaft	Insulated shaft		
		20mm size	12mm size		18mm size
Series		EC20A	EC12E	EC12D	EC18A
Photo					
Output		Incremental (Two phase A and B)			Absolute type
Shaft types		Single-shaft			
Operating direction		Vertical			
Number of pulse / Number of detent		18/18	12/12 24/24 24/without	15/30	12 positions 15 positions 16 positions
Features		—	—	With push-on switch	Water resisting performance (IPX7)
Dimensions (mm)	W	20.2	12.4	12.5	18.8
	D	19.2	13.2	11.7	18
	H	10	5		8.75
Operating temperature range		-30°C to +80°C	-10°C to +70°C	-40°C to +85°C	-20°C to +60°C
Operating life		30,000 cycles	15,000 cycles 30,000 cycles	30,000 cycles	
Automotive use		●	—	●	—
Life cycle (availability)					
Electrical performance	Rating	1mA 5V DC	0.5mA 5V DC	1mA 5V DC	1mA 10V DC
	Max./min. operating current (Resistive load)	—	5mA / 0.5mA	10mA / 1mA	—
	Insulation resistance	10MΩ min. 50V DC		100MΩ min. 250V DC	10MΩ min. 250V DC
	Voltage proof	50V AC for 1 minute or 60V AC for 2s	50V AC for 1 minute	300V AC for 1 minute or 360V AC for 1s	50V AC for 1 minute or 60V AC for 2s
Mechanical performance	Rotational torque (Without detent)	—	10mN·m max. 25±15mN·m 40±15mN·m	—	—
	Detent torque	40±20mN·m	3±2mN·m 3 to 20mN·m	5±3mN·m 10±5mN·m	60±20mN·m
	Push-pull strength	100N	80N	100N	Push 100N / Pull 50N
Shaft configuration		Flat	Flat, Through shaft	Flat	
Terminal type		Insertion			
Switch Specifications	Switch type	Push-on switch	—	Push-on switch	—
	Contact arrangement	Single pole and single throw (Push-on)	—	Single pole and single throw (Push-on)	—
	Travel (mm)	1.5±0.5	—	0.5±0.3	—
	Operating force (N)	4±2	—	3 ^{+1.5} ₋₁ 6 ^{+2.5} ₋₂	—
	Rating	0.1A 5V DC (0.1mA 5V DC min. ratings)	—	1mA 5V DC (10mA 5V DC max. ratings)	—
	Contact resistance	100mΩ max. for initial period; 200mΩ max. after operating life.	—	100mΩ max. for initial period; 200mΩ max. after operating life.	—
	Operating life	20,000 times	—	30,000 times	—
Page		273	276		280

Encoders Soldering Conditions	299
Encoders Cautions	300

Note

● Indicates applicability to all products in the series.

Reference for Manual Soldering

Series	Tip temperature	Soldering time	No. of solders
EC05E, EC09E, EC10E, EC111, EC11B, EC11E, EC11G, EC11K, EC11M, EC11N, EC12D, EC12E, EC18A, EC21A, EC28A, EC35A, EC35AH, EC40A, EC45A, EC50A, EC60B, EM11B, EC21C, EC28C, EC35CH	350°C max.	3s max.	1 time
EC11J	350±10°C	3 ⁺¹ ₀ s	2 times

Reference for Dip Soldering

Series	Preheating		Dip soldering		No. of solders
	Soldering surface temperature	Heating time	Soldering temperature	Soldering time	
EC09E, EC11B, EC111, EC11E, EC11G, EC11K, EC11M, EC11N, EC18A, EC21A, EC28A, EC35A, EC35AH, EC50A, EC60B	100°C max.	2 min. max.	260±5°C	5±1s	2 times max.
EM11B	100°C max.	1 min. max.	260°C max.	3s max.	2 times max.
EC10E, EC12D, EC12E	100°C max.	1 min. max.	260±5°C	3±1s	2 times max.
EC40A	110°C max.	1 min. max.	260°C max.	10s max.	1 time
EC45A	100°C max.	2 min. max.	260°C max.	5s max.	2 times max.

Example of Reflow Soldering Condition

Temperature profile

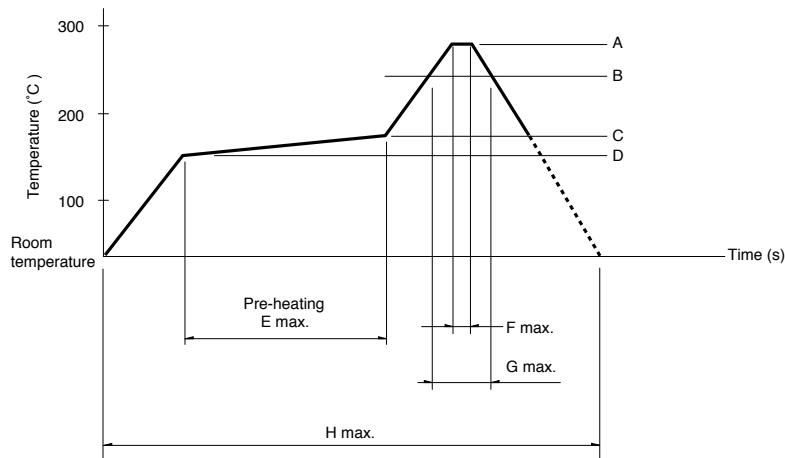

Series	A	B	C	D	E	F	G	H	No. of reflows
EC11J	260°C	230°C	180°C	150°C	2 min. max.	3s	40s	4 min. max.	2 times max.
EC05E	250°C min.	230°C min.	180°C	150°C	60s to 120s	—	30s to 40s	—	2 times max.
EC21C	230°C to 245°C	220°C	200°C	150°C	60s to 120s	—	25s to 60s	300s max.	1 time max.
EC28C, EC35CH	260°C	230°C	180°C	150°C	2 min. min.	3s	40s	230s max.	1 time max.

Notes

- When using an infrared reflow oven, solder may sometimes not be applied. Be sure to use a hot air reflow oven or a type that uses infrared rays in combination with hot air.
- The temperatures given above are the maximum temperatures at the terminals of the encoder when employing a hot air reflow method. The temperature of the PC board and the surface temperature of the encoder may vary greatly depending on the PC board material, its size and thickness. Ensure that the surface temperature of the encoder does not rise to 250°C or greater.
- Conditions vary to some extent depending on the type of reflow bath used. Be sure to give due consideration to this prior to use.

Компания «Life Electronics» занимается поставками электронных компонентов импортного и отечественного производства от производителей и со складов крупных дистрибьюторов Европы, Америки и Азии.

С конца 2013 года компания активно расширяет линейку поставок компонентов по направлению коаксиальный кабель, кварцевые генераторы и конденсаторы (керамические, пленочные, электролитические), за счёт заключения дистрибьюторских договоров

Мы предлагаем:

- Конкурентоспособные цены и скидки постоянным клиентам.
- Специальные условия для постоянных клиентов.
- Подбор аналогов.
- Поставку компонентов в любых объемах, удовлетворяющих вашим потребностям.
- Приемлемые сроки поставки, возможна ускоренная поставка.
- Доставку товара в любую точку России и стран СНГ.
- Комплексную поставку.
- Работу по проектам и поставку образцов.
- Формирование склада под заказчика.
- Сертификаты соответствия на поставляемую продукцию (по желанию клиента).
- Тестирование поставляемой продукции.
- Поставку компонентов, требующих военную и космическую приемку.
- Входной контроль качества.
- Наличие сертификата ISO.

В составе нашей компании организован Конструкторский отдел, призванный помогать разработчикам, и инженерам.

Конструкторский отдел помогает осуществить:

- Регистрацию проекта у производителя компонентов.
- Техническую поддержку проекта.
- Защиту от снятия компонента с производства.
- Оценку стоимости проекта по компонентам.
- Изготовление тестовой платы монтаж и пусконаладочные работы.



Тел: +7 (812) 336 43 04 (многоканальный)
Email: org@lifeelectronics.ru