



# OLED0821

---

Including OLED0821

## Technical Manual

Revision 1.1

**PCB Revision: 2.0 or Higher**

**Firmware Revision: 5.0 or Higher**

## Revision History

Revision	Date	Description	Author
1.1	January 4, 2018	Correction to Set Non-Standard Baud Rate command	Divino
1.0	January 8, 2016	Initial Release	Divino

# Contents

1 Introduction .....	1
2 Quick Connect Guide.....	2
2.1 Available Headers .....	2
2.2 Standard Module .....	3
Recommended Parts.....	3
Serial Connections.....	3
I <sup>2</sup> C Connections .....	4
3 Software .....	5
3.1 uProject.....	5
3.2 Application Notes.....	6
4 Hardware.....	7
4.1 Standard Model .....	7
Communication/Power Header .....	7
Alternate Serial Header.....	7
Protocol Select Jumpers.....	7
4.2 Common Features.....	8
General Purpose Outputs .....	8
5 Troubleshooting.....	9
5.1 Power .....	9
5.2 Display.....	9
5.3 OLED Burn-In.....	9
5.4 Communication.....	10
5.5 Manual Override .....	10
6 Commands .....	11
6.1 Communication.....	11
6.2 Text.....	12
6.3 Special Characters.....	14
6.4 General Purpose Output .....	16
6.5 Display Functions .....	17
6.6 Data Security.....	17

6.7 Miscellaneous .....	19
7 Appendix .....	20
7.1 Command Summary .....	20
7.2 Character Sets .....	22
7.3 Block Diagram .....	23
7.4 Environmental Specifications.....	23
7.5 Electrical Tolerances .....	23
7.6 Dimensional Drawings .....	24
7.7 Optical Characteristics .....	25
8 Ordering .....	25
8.1 Part Numbering Scheme .....	25
8.2 Options.....	25
8.3 Accessories.....	26
9 Definitions .....	27
10 Contact.....	27

# 1 Introduction



*Figure 1: OLED0821 Display*

The OLED0821 is an intelligent alphanumeric organic light emitting diode display designed to decrease development time by providing an instant solution to any project. RS232, TTL and I2C protocol communication options allow the OLED0821 to be connected to a wide variety of host controllers. Communication speeds of up to 115.2kbps for serial protocols and 100kbps for I<sup>2</sup>C ensure lightning fast display updates.

The simple command structure permits easy software control of many settings including brightness and baud rate. On board memory provides up to forty custom characters which can be saved within the unit and recalled for start screens, bar graphs or larger numbers. Finally, one general purpose outputs provide simple switchable five volt sources.

The versatile OLED0821, with all the features mentioned above, is available in a variety of colour, voltage, and temperature options to suit almost any application.

## 2 Quick Connect Guide

### 2.1 Available Headers

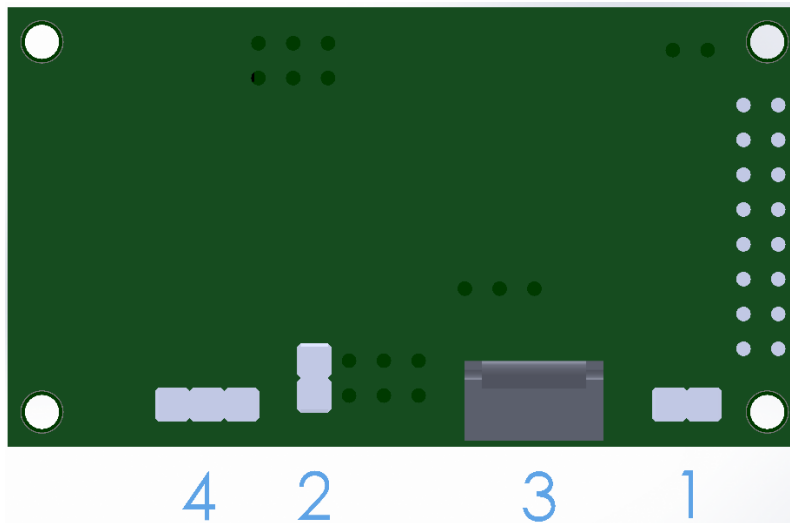

Figure 2: OLED0821 Standard Module Header Locations

Table 1: List of Available Headers

#	Header	Mate	Population
1	GPO Header	None Offered	All Models
2	Manual Override	Jumper	All Models
3	Communication/Power Connector	SCCPC5V/BBC	All Models
4	Alternate Serial Header	None Offered	All Models

## 2.2 Standard Module

The standard version of the OLED0821 allows for user configuration of two common communication protocols. First, the unit can communicate using serial protocol at either RS232 or TTL voltage levels. Second, it can communicate using the Inter-Integrated Circuit connect, or I<sup>2</sup>C protocol. Connections for each protocol can be accessed through the four pin Communication/Power Header as outlined in the Serial Connections and I<sup>2</sup>C Connections sections below.

### Recommended Parts



Figure 3: Communication/Power Cable (SCCPC5V)

The most common cable choice for any alphanumeric Matrix Orbital Display, the Communication/ Power Cable offers a simple connection to the unit with familiar interfaces. DB9 and floppy power headers provide all necessary input to drive your display.



Figure 4: Breadboard Cable (BBC)

For a more flexible interface to the OLED0821 a Breadboard Cable may be used. This provides a simple four wire connection that is popular among developers for its ease of use in a breadboard environment.

### Serial Connections

A serial interface provides a classic connection to the OLED0821. The Communication/Power Cable is most commonly used for this set up as it provides connections for DB9 serial and floppy power cables. To place your board in Serial mode, adhere to the steps laid out below.

1. Set the Protocol Select jumpers.
  - RS232: Connect the three jumpers\* in the 232 protocol box with the zero ohm jumper resistors provided or an alternate wire or solder solution.
  - TTL: Connect the two jumpers\* in the TTL protocol box.

**\*Note:** Jumpers must be removed from all protocol boxes save for the one in use.

2. Make the connections.
  - a. Connect the four pin female header of the Communication/Power Cable to the Communication/Power Header of your OLED0821.
  - b. Insert the male end of your serial cable to the corresponding DB9 header of the Communication/Power Cable and mate the female connector with the desired communication port of your computer.
  - c. Select an unmodified floppy cable from a PC power supply and connect it to the power header of the Communication/Power Cable.
3. Create.
  - Use uProject or a terminal program to get started, and then move on with your own development. A number of application notes are available at [www.matrixorbital.ca/appnotes](http://www.matrixorbital.ca/appnotes).

### I<sup>2</sup>C Connections

A more advanced connection to the OLED0821 is provided by the I<sup>2</sup>C protocol setting. This is best accomplished using a breadboard and the Breadboard Cable. Power must be supplied from your breadboard or another external source. To dive right into your application and use the OLED0821 in I<sup>2</sup>C mode, get started with the guidelines below.

1. Set the Protocol Select switches.
  - I<sup>2</sup>C: Ensure that the two I<sup>2</sup>C jumpers in the corresponding protocol box are connected while all others are open.
2. Make the connections.
  - a. Connect the Breadboard Cable to the Communication/Power Header on your OLED0821 and plug the four leads into your breadboard. The red lead will require power, while the black should be connected to ground, and the green and yellow should be connected to your controller clock and data lines respectively.
  - b. Pull up the clock and data lines to five volts using a resistance between one and ten kilohms on your breadboard.
3. Create.
  - This time you're on your own. While there are many examples within the Matrix Orbital AppNote section, [www.matrixorbital.ca/appnotes](http://www.matrixorbital.ca/appnotes), too many controllers and languages exist to cover them all. If you get stuck in development, it is possible to switch over to another protocol on the standard board, and fellow developers are always on our forums for additional support.



## 3 Software

The multiple communication protocols available and simple command structure of the OLED0821 means that a variety of applications can be used to communicate with the display. Text is sent to the display as a character string, for example, sending the decimal value 41 will result in an 'A' appearing on the screen. A number of control characters are also activated. Commands are merely values prefixed with a special command byte, 254 in decimal.

Table 2: Reserved Control Characters

Control Characters							
8	Backspace	10	Line feed / New line	12	Clear screen / New page	13	Carriage return

Once the correct communication port is identified, the following communication settings can be applied to communicate correctly with the OLED0821.

Table 3: Communication Settings

BPS	Data Bits	Parity	Stop Bits	Flow Control
19200	8	None	1	None

Finally, with a communication port identified and correctly setup simple text strings or even command bytes can easily be transmitted to control your display.

### 3.1 uProject

The Matrix Orbital alphanumeric display tuner, or uProject, is offered as a free download from the [www.matrixorbital.ca](http://www.matrixorbital.ca) support site. It allows the basic functionality of \*any display to be tested using a simple graphical user interface system.

While basic functionality can be tested using the GUI portion of the program, more advanced users will enjoy the scripting capability found in the uploader tab. Here commands can be stacked, run, and saved for later use. Although many commands are available to be dragged into the script dialog, perhaps the most powerful is the raw data command found in the other branch.

**\*Note:** The uProject AutoDetect function will not perform correctly when a USB display is connected. Please manually configure any USB display.

This command allows raw bytes to be sent to the display, permitting many different formats for entry and displaying in decimal notation. Any command from this manual may be entered in decimal notation separated by slashes.

***/254/ /88/***

*Figure 5: uProject Command*

Again, the clear screen command is sent to a connected display, this time using uProject raw data command style. Scripts can be run as a whole using the execute command from the script menu, or as single commands by selecting execute once. Before issuing commands, it is a good idea to ensure communication with a display is successful using some of the more basic GUI functions in the main window.

This program provides scratch pad upon which a tome of display projects and ideas can be assembled.

### 3.2 Application Notes

Full demonstration programs and code are available for Matrix Orbital Displays in the C# language from Simple C# AppNote Pack in the Application Note section at [www.matrixorbital.ca/appnotes](http://www.matrixorbital.ca/appnotes). Difficulty increases from beginner, with the Hello World program, to advanced with the Dallas One-Wire temperature reading application.

Many additional applications are available in a number of different programming languages. These programs are meant to showcase the capability of the display and are not intended to be integrated into a final design. For additional information regarding code, please read the On Code document also found on the support site.

## 4 Hardware

### 4.1 Standard Model

#### Communication/Power Header

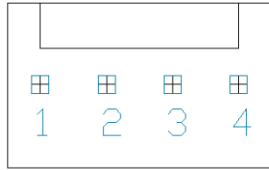

Figure 6: Communication/Power Header

Table 4: Communication/Power Pinout

Pin	Function
1	Vcc
2	Rx (SCL)
3	Tx (SDA)
4	Gnd

The Communication/Power Header provides a standard connector for interfacing to the OLED0821. Voltage is applied through pins one and four of the four pin Communication/Power Header. Please ensure the correct voltage input for your display by referencing Voltage Specifications before connecting power. Pins two and three are reserved for serial transmission, using either the RS-232/TTL or clocking data through the I<sup>2</sup>C protocol, depending on what has been selected by the Protocol Select Jumpers. The versatile Tyco 640456-4-LF style header used can be mated to a number of connectors, the Molex 22-01-3047 for example.

#### Alternate Serial Header

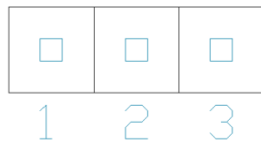

Figure 7: Communication/Power Header

Table 5: Communication/Power Pinout

Pin	Function
1	Gnd
2	Rx (SCL)
3	Vcc

#### Protocol Select Jumpers

The Protocol Select Jumpers provide the means necessary to toggle the OLED0821 between RS-232, TTL and I<sup>2</sup>C protocols. As a default, the jumpers are set to RS-232 mode with solder jumps on the RS-232 jumpers. In order to place the display module in I<sup>2</sup>C mode you must first remove the solder jumps from the RS-232 jumpers and then place them on the I<sup>2</sup>C jumpers. The display will now be in I<sup>2</sup>C mode and have a default slave address of 80, unless changed with the appropriate command. Similarly, in order to change the display to TTL mode, simply remove the zero ohm resistors from the RS-232 or I<sup>2</sup>C jumpers and solder them to the TTL jumpers.

## 4.2 Common Features

### General Purpose Outputs

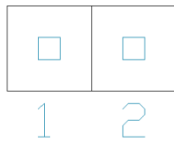

Figure 8: GPO Header

Table 6: GPO Pinout

Pin	Function
1	GPO
2	Gnd

A unique feature of the OLED0821 is the ability to control relays\* and other external devices using a single General Purpose Output. It can source up to 10mA of current at five volts when on or sink 20mA at zero volts when off. The two pin header can be interfaced to a number of female connectors to provide control to any peripheral devices required.

**\*Note:** If connecting a relay, be sure that it is fully clamped using a diode and capacitor in order to absorb any electro-motive force (EMF) which will be generated.

## 5 Troubleshooting

### 5.1 Power

In order for your OLED0821 to function correctly, it must be supplied with the appropriate power. If the display is not illuminated, power is not applied correctly. Try following the tips below.

- First, make sure that you are using the correct power connector. Standard floppy drive power cables from your PC power supply may fit on the Communication/Power Header; however they do not have the correct pin out to provide power. Matrix Orbital supplies power cable adapters for connecting to a PC, which can be found in the accessories section.
- Next, check the power cable which you are using for continuity. If you don't have an ohm meter, try using a different power cable, if this does not help try using a different power supply.
- If power is applied through the DB9 connector, ensure that the Power Through DB9 Jumper is connected.
- If changes have been made to the protocol select block, ensure all the appropriate protocol select jumpers are connected and all unused protocol jumpers are disconnected.
- The last step will be to check the interface connector in use on your display. If the power connections have become loose, or you are unable to resolve the issue, please contact Matrix Orbital for more information.

### 5.2 Display

If your display is powered successfully, the Matrix Orbital logo, or user created screen should display on start up. If this is not the case, check out these tips.

- Ensure the brightness is not too low. This can result in a darkened or blank screen respectively. See the Manual Override section to reset to default.
- Make sure that the start screen is not blank. It is possible to overwrite the Matrix Orbital logo start screen, if this happens the screen may be blank. Try writing to the display to ensure it is functional, after checking the brightness above.

### 5.3 OLED Burn-In

OLED technology is susceptible to a burn-in effect; whereby the brightness of active pixels may differ from inactive ones over an extended period of activation. To reduce the burn-in effect, please use a dynamic screen saver or simply turn the screen off when not in active use.

## 5.4 Communication

When communication of either text or commands is interrupted, try the steps below.

- First, check the communication cable for continuity. If you don't have an ohm meter, try using a different communication cable. If you are using a PC try using a different Com/USB Port.
- Next, please ensure that the display module is set to communicate on the protocol that you are using, by checking the Protocol Select Jumpers.
- In serial and USB protocols, ensure that the host system and display module are both communicating on the same baud rate. The default rate for the display module is 19200 bps.
- Match Rx from your display to the transmitting pin from your host and the Tx pin to the receiving pin.
- If you are communicating to the display via I<sup>2</sup>C\* please ensure that the data is being sent to the correct address. The default slave address for the display module is 80.
- In I<sup>2</sup>C mode, connect Rx to the clock line of your controller and Tx to the data output.
- Unlock the display. See the Set and Save Data Lock command for more info.
- Finally, you may reset the display to its default settings using the Manual Override procedure outlined below.

**\*Note:** I<sup>2</sup>C communication will always require pull up resistors on SCL and SDA of one to ten kilohms.

## 5.5 Manual Override

Should the settings of your display become altered in a way that dramatically impacts usability, the default settings can be temporarily restored. To override the display, please follow the steps below.

1. Disconnect power from your display.
2. Place a jumper on the manual override pins.
3. Reconnect power to your unit, and wait for the start screen before removing the jumper.
4. Settings will be temporarily\*\* overridden to the defaults listed in the Manual Override Settings table. At this point any important settings, such as brightness, or baud rate, should not only be set but saved so they remain when the override is removed.

Parameter	Value
Brightness	255
Baud Rate	19200
I <sup>2</sup> C Address	80

*Table 7: Manual Override Settings*

**\*\*Note:** The display module will revert back to the old settings once turned off, unless desired settings are saved.

## 6 Commands

### 6.1 Communication

1.1 Change Baud Rate	Dec	<b>254 57</b>	Speed	<b>v5.0</b>
	Hex	<b>FE 39</b>	Speed	
	ASCII	<b>■ 9</b>	Speed	
Immediately changes the baud rate. Not available in I2C. Baud rate can be temporarily forced to 19200 by a manual override.				
<b>Speed</b>	<b>Byte</b>	Valid settings shown below.		

Table 8: Accepted Baud Rate Values

<b>Rate</b>	1200	2400	4800	9600	19200	28800	38400	57600	76800	115200
<b>Speed</b>	83	41	207	103	51	34	25	16	12	8

1.2 Change I <sup>2</sup> C Slave Address	Dec	<b>254 51</b>	Address	<b>v5.0</b>
	Hex	<b>FE 33</b>	Address	
	ASCII	<b>■ 3</b>	Address	
Immediately changes the I <sup>2</sup> C write address. Only even values are permitted as the next odd address will become the read address. Default is 80.				
<b>Address</b>	<b>Byte</b>	Even value.		

1.3 Transmission Protocol Select	Dec	<b>254 160</b>	Protocol	<b>v5.0</b>
	Hex	<b>FE A0</b>	Protocol	
	ASCII	<b>■ á</b>	Protocol	
Selects the protocol used for data transmission from the display. Data transmission to the display is not affected. Must be set to the protocol in use to receive data correctly.				
<b>Protocol</b>	<b>Byte</b>	1 for Serial (RS232/TTL) or 0 for I <sup>2</sup> C.		

1.4 Set a Non-Standard Baud Rate	Dec	<b>254 164</b>	Speed	<b>v5.0</b>
	Hex	<b>FE A4</b>	Speed	
	ASCII	<b>■ ñ</b>	Speed	
Immediately changes the baud rate to a non-standard value. Baud must be a whole number between 977 and 153800. Due to rounding, error increases with baud rate, actual baud must be within 3% of desired baud to ensure accurate communication. Not available in I2C. Can be temporarily forced to 19200 by a manual override.				
<b>Speed</b>	<b>Short</b>	Calculations shown below, standard crystal speed is 16MHz.		

$$Speed = \frac{CrystalSpeed}{(8 \times DesiredBaud)} - 1 \quad ActualBaud = \frac{CrystalSpeed}{(8 \times (Speed + 1))}$$

*Equation 1: Speed Byte Calculation*      *Equation 2: Actual Baud Rate Calculation*

$$\frac{|DesiredBaud - ActualBaud|}{DesiredBaud} < 0.03$$

Equation 3: Baud Rate Error Calculation

## 6.2 Text

2.1 Clear Screen	Dec	<b>254 88</b>		v5.0
	Hex	<b>FE 58</b>		
	ASCII	<b>■ X</b>		

Clears the contents of the screen.

2.2 Change the Start Up Screen	Dec	<b>254 64</b>	Characters	v5.0
	Hex	<b>FE 40</b>	Characters	
	ASCII	<b>■ @</b>	Characters	

Changes the message displayed on start up. Custom characters can be included by adding their decimal value (0-7). Characters will automatically wrap on the display.

**Characters** 16 bytes, space characters can be added as needed

2.3 Auto Scroll On	Dec	<b>254 81</b>		v5.0
	Hex	<b>FE 51</b>		
	ASCII	<b>■ Q</b>		

The entire contents of screen are shifted up one line when the end of the screen is reached. Display default is on.

2.4 Auto Scroll Off	Dec	<b>254 82</b>		v5.0
	Hex	<b>FE 52</b>		
	ASCII	<b>■ R</b>		

New text is written over the top line when the end of the screen is reached. Display default is Auto Scroll on.

2.5 Set Auto Line Wrap On	Dec	<b>254 67</b>		v5.0
	Hex	<b>FE 43</b>		
	ASCII	<b>■ C</b>		

Text will wrap to the next consecutive line once a row becomes full. Default is Auto Line Wrap on.

2.6 Set Auto Line Wrap Off	Dec	<b>254 68</b>		v5.0
	Hex	<b>FE 44</b>		
	ASCII	<b>■ D</b>		

Text will skip one line when wrapping once a row becomes full. Writing order will be rows 1, 3, 2, and then 4. Default is Auto Line Wrap on.

2.7 Set Cursor Position	Dec	<b>254 71</b>	Column Row	v5.0
	Hex	<b>FE 47</b>	Column Row	
	ASCII	<b>■ G</b>	Column Row	

Sets the cursor to a specific cursor position where the next transmitted character is printed.

**Column** **Byte** Value between 1 and 8.

**Row** **Byte** Value between 1 and 2.



2.8 Go Home	Dec	254 72	v5.0
	Hex	FE 48	
	ASCII	■ H	
Returns the cursor to the top left of the screen.			

2.9 Move Cursor Back	Dec	254 76	v5.0
	Hex	FE 4C	
	ASCII	■ L	
Moves cursor one position to the left. Cursor will obey wrap settings.			

2.10 Move Cursor Forward	Dec	254 77	v5.0
	Hex	FE 4D	
	ASCII	■ M	
Moves cursor one position to the right. Cursor will obey wrap settings.			

2.11 Underline Cursor On	Dec	254 74	v5.0
	Hex	FE 4A	
	ASCII	■ J	
Displays a line under the current cursor position. Can be used with blinking cursor.			

2.12 Underline Cursor Off	Dec	254 75	v5.0
	Hex	FE 4B	
	ASCII	■ K	
Removes line under current cursor position.			

2.13 Blinking Cursor On	Dec	254 83	v5.0
	Hex	FE 53	
	ASCII	■ S	
Displays a blinking cursor over the current cursor position. Can be used with underline.			

2.14 Blinking Cursor Off	Dec	254 84	v5.0
	Hex	FE 54	
	ASCII	■ T	
Removes blinking cursor over current cursor position.			

## 6.3 Special Characters

3.1 Create a Custom Character	Dec	<b>254 78</b>	ID Data	v5.0
	Hex	<b>FE 4E</b>	ID Data	
	ASCII	<b>■ N</b>	ID Data	

Creates a custom character. Each character is divided into 8 rows of 5 pixels; each data byte represents one row. Each byte is padded by three zero bits followed by five bits representing each pixel state. A one represents an on condition while a zero is off. Characters are lost when a new memory bank is loaded, unless they are saved.

<b>ID</b>	<b>Byte</b>	Character ID, value between 0 and 7.
<b>Data</b>	<b>Byte[8]</b>	Character pixel data as shown below.

Table 9: Custom Degree Character

<b>Data[1]</b>	000	p1	p2	p3	p4	p5	00001000	<b>8</b>
<b>Data[2]</b>	000	p1	p2	p3	p4	p5	00010100	<b>20</b>
<b>Data[3]</b>	000	p1	p2	p3	p4	p5	00001000	<b>8</b>
<b>Data[4]</b>	000	p1	p2	p3	p4	p5	00000011	<b>3</b>
<b>Data[5]</b>	000	p1	p2	p3	p4	p5	00000100	<b>4</b>
<b>Data[6]</b>	000	p1	p2	p3	p4	p5	00000100	<b>4</b>
<b>Data[7]</b>	000	p1	p2	p3	p4	p5	00000011	<b>3</b>
<b>Data[8]</b>	000	p1	p2	p3	p4	p5	00000000	<b>0</b>

3.2 Save Custom Characters	Dec	<b>254 193</b>	Bank ID Data	v5.0
	Hex	<b>FE C1</b>	Bank ID Data	
	ASCII	<b>■ ñ</b>	Bank ID Data	

Provides access to all memory banks to create and save custom characters, graph bars, and large digits. Any new characters saved will overwrite the old, so care should be taken when writing to any bar or digit memory bank. Bank structure is shown below.

<b>Bank</b>	<b>Byte</b>	1 byte, memory bank ID, value between 0 and 4, as below.
<b>ID</b>	<b>Byte</b>	1 byte, value between 0 and 7.
<b>Data</b>	<b>Byte[8]</b>	8 bytes, character pixel data as above.

Table 10: Custom Character Banks

<b>0</b>	Start-up Characters	<b>1</b>	Horizontal Bars	<b>2</b>	Vertical Bars	<b>3</b>	Medium Digits	<b>4</b>	Large Digits
----------	---------------------	----------	-----------------	----------	---------------	----------	---------------	----------	--------------

3.3 Load Custom Characters	Dec	<b>254 192</b>	Bank	v5.0
	Hex	<b>FE C0</b>	Bank	
	ASCII	<b>■ L</b>	Bank	

Loads a bank of custom characters into memory for use. Must be issued before using a bank of characters. Alternatively, an appropriate initialize command can be used.

<b>Bank</b>	<b>Byte</b>	Memory bank ID, value between 0 and 4, as above.
-------------	-------------	--

3.4 Save Start Up Screen Custom Characters	Dec	<b>254 194</b>	ID Data	<b>v5.0</b>
	Hex	<b>FE C2</b>	ID Data	
	ASCII	<b>■ T</b>	ID Data	
Saves a custom character to memory for the start up screen or repeated use. Start up characters are displayed by sending their ID to the screen.				
<b>ID</b>	<b>Byte</b>	Value between 0 and 7.		
<b>Data</b>	<b>Byte[8]</b>	Character pixel data, see Custom Degree Character example.		

3.5 Initialize Medium Numbers	Dec	<b>254 109</b>		<b>v5.0</b>
	Hex	<b>FE 6D</b>		
	ASCII	<b>■ m</b>		
Loads the medium number custom character bank into memory. Medium numbers must be initialized before use.				

3.6 Place Medium Numbers	Dec	<b>254 111</b>	Row Column Digit	<b>v5.0</b>
	Hex	<b>FE 6F</b>	Row Column Digit	
	ASCII	<b>■ o</b>	Row Column Digit	
Places a single medium decimal digit of 2 row height and 1 column width on the display at the position specified. Medium numbers must be initialized before being placed.				
<b>Row</b>	<b>Byte</b>	Value between 1 and 8.		
<b>Column</b>	<b>Byte</b>	Value between 1 and 2.		
<b>Digit</b>	<b>Byte</b>	Single decimal digit to display.		

3.7 Initialize Horizontal Bar	Dec	<b>254 104</b>		<b>v5.0</b>
	Hex	<b>FE 68</b>		
	ASCII	<b>■ h</b>		
Loads the horizontal bar graph custom character bank into memory. Horizontal bar characters must be initialized before a graph is displayed.				

3.8 Place Horizontal Bar Graph	Dec	<b>254 124</b>	Column Row Direction Length	<b>v5.0</b>
	Hex	<b>FE 7C</b>	Column Row Direction Length	
	ASCII	<b>■  </b>	Column Row Direction Length	
Places a horizontal bar graph on the screen beginning at the column and row specified. The bar extends either right or left to the length indicated. New bars will overwrite old.				
<b>Column</b>	<b>Byte</b>	1 byte, value between 1 and 8.		
<b>Row</b>	<b>Byte</b>	1 byte, value between 1 and 2.		
<b>Direction</b>	<b>Byte</b>	1 byte, 0 for right and 1 for left.		
<b>Length</b>	<b>Byte</b>	1 byte, length in pixels of the graph, value between 0 and 40.		

3.9 Initialize Narrow Vertical Bar	Dec	<b>254 115</b>		<b>v5.0</b>
	Hex	<b>FE 73</b>		
	ASCII	<b>■ s</b>		
Loads the narrow horizontal bar graph custom character bank into memory. A narrow bar is 2 pixels wide. Horizontal bar characters must be initialized before a graph is displayed.				

3.10 Initialize Wide Vertical Bar	Dec	<b>254 118</b>		<b>v5.0</b>
	Hex	<b>FE 76</b>		
	ASCII	<b>■ v</b>		

Loads the wide horizontal bar graph custom character bank into memory. A wide bar is 5 pixels wide. Horizontal bar characters must be initialized before a graph is displayed.

3.11 Place Vertical Bar	Dec	<b>254 61</b>	Column Length	<b>v5.0</b>
	Hex	<b>FE 3D</b>	Column Length	
	ASCII	<b>■ =</b>	Column Length	

Places a vertical bar graph on the screen extending from the first row of the column specified. The bar extends upwards to the length indicated. A new bar will over write the old.

<b>Column</b>	<b>Byte</b>	Value between 1 and 8.
<b>Length</b>	<b>Byte</b>	Height in pixels of the graph, value between 0 and 16.

## 6.4 General Purpose Output

4.1 General Purpose Output On	Dec	<b>254 87</b>	Number	<b>v5.0</b>
	Hex	<b>FE 57</b>	Number	
	ASCII	<b>■ W</b>	Number	

Turns the specified GPO on, sourcing current from an output of five volts.

<b>Number</b>	<b>Byte</b>	GPO to be turned on.
---------------	-------------	----------------------

4.2 General Purpose Output Off	Dec	<b>254 86</b>	Number	<b>v5.0</b>
	Hex	<b>FE 56</b>	Number	
	ASCII	<b>■ V</b>	Number	

Turns the specified GPO off, sinking current to an output of zero volts.

<b>Number</b>	<b>Byte</b>	GPO to be turned off.
---------------	-------------	-----------------------

4.3 Set Start Up GPO State	Dec	<b>254 195</b>	Number State	<b>v5.0</b>
	Hex	<b>FE C3</b>	Number State	
	ASCII	<b>■  </b>	Number State	

Sets and saves the start up state of the specified GPO in non volatile memory. Changes will be seen on start up.

<b>Number</b>	<b>Byte</b>	GPO to be controlled.
<b>State</b>	<b>Byte</b>	1 for on or 0 for off.

## 6.5 Display Functions

5.1 Brightness On	Dec	<b>254 66</b>	Minutes	v5.0
	Hex	<b>FE 42</b>	Minutes	
	ASCII	<b>■ B</b>	Minutes	
Turns the brightness on for a specified length of time. If an inverse display color is used this command will essentially turn on the text.				
<b>Minutes</b>	<b>Byte</b>	Number of minutes to leave brightness on, a value of 0 leaves the display on indefinitely.		

5.2 Brightness Off	Dec	<b>254 70</b>		v5.0
	Hex	<b>FE 46</b>		
	ASCII	<b>■ F</b>		
Turns the display brightness off. If an inverse display colour is used this command will turn off the text.				

5.3 Set Brightness	Dec	<b>254 153</b>	Brightness	v5.0
	Hex	<b>FE 99</b>	Brightness	
	ASCII	<b>■ Ö</b>	Brightness	
Immediately sets the brightness. If an inverse display color is used this represents the text colour intensity instead. Default is 255.				
<b>Brightness</b>	<b>Byte</b>	Brightness level from 0(Dim) to 255(Bright).		

5.4 Set and Save Brightness	Dec	<b>254 152</b>	Brightness	v5.0
	Hex	<b>FE 98</b>	Brightness	
	ASCII	<b>■ ÿ</b>	Brightness	
Immediately sets and saves the brightness. Although brightness can be changed using the set command, it is reset to this saved value on start up. Default is 255.				
<b>Brightness</b>	<b>Byte</b>	Brightness level from 0(Dim) to 255(Bright).		

## 6.6 Data Security

6.1 Set Remember	Dec	<b>254 147</b>	Switch	v5.0
	Hex	<b>FE 93</b>	Switch	
	ASCII	<b>■ ô</b>	Switch	
Allows changes to specific settings to be saved to the display memory. Writing to non-volatile memory can be slow and each change consumes 1 write of at least 100,000 available. The Command Summary outlines which commands are saved always, never, and when this command is on only. Remember is off by default.				
<b>Switch</b>	<b>Byte</b>	1 for on or 0 for off.		

6.2 Set Data Lock	Dec	<b>254 202 245 160</b>	Level	<b>v5.0</b>
	Hex	<b>FE CA F5 A0</b>	Level	
	ASCII	<b>■ ¨   á</b>	Level	
Temporarily locks certain aspects of the display to ensure no inadvertent changes are made. The lock is released after a power cycle. A new level overrides the old, and levels can be combined. Default is 0.				
<b>Level</b>	<b>Byte</b>	Lock level, see Data Lock Bits table.		

Table 11: Data Lock Bits

Display	Command	Reserved	Setting	Address	Reserved	Reserved	Reserved
7	6	5	4	3	2	1	0

Table 12: Lock Parameters

<b>Reserved</b>	Place holders only, should be 0
<b>Address</b>	Locks the Baud Rate and I2C address
<b>Setting</b>	Locks all settings from being saved
<b>Command</b>	Locks all commands, text can still be written
<b>Display</b>	Locks entire display, no new text can be displayed

6.3 Set and Save Data Lock	Dec	<b>254 203 245 160</b>	Level	<b>v5.0</b>
	Hex	<b>FE CB F5 A0</b>	Level	
	ASCII	<b>■ ¨   á</b>	Level	
Locks certain aspects of the display to ensure no inadvertent changes are made. The lock is not affected by a power cycle. A new level overrides the old, and levels can be combined. Default is 0.				
<b>Level</b>	<b>Byte</b>	See Data Lock Bits table.		

## 6.7 Miscellaneous

7.1 Write Customer Data	Dec	<b>254 52</b>	Data	<b>v5.0</b>
	Hex	<b>FE 34</b>	Data	
	ASCII	<b>■ 4</b>	Data	
Saves a user defined block of data to non-volatile memory. Useful for storing display information for later use.				
<b>Data</b>	<b>Byte [16]</b>	User defined data.		
7.2 Read Customer Data	Dec	<b>254 53</b>		<b>v5.0</b>
	Hex	<b>FE 35</b>		
	ASCII	<b>■ 5</b>		
Reads data previously written to non-volatile memory. Data is only changed when written, surviving power cycles.				
<b>Response</b>	<b>Byte [16]</b>	Previously saved user defined data.		
7.3 Read Version Number	Dec	<b>254 54</b>		<b>v5.0</b>
	Hex	<b>FE 36</b>		
	ASCII	<b>■ 6</b>		
Causes display to respond with its firmware version number. Test.				
<b>Response</b>	<b>Byte</b>	Convert to hexadecimal to view major and minor revision numbers.		
7.4 Read Module Type	Dec	<b>254 55</b>		<b>v5.0</b>
	Hex	<b>FE 37</b>		
	ASCII	<b>■ 7</b>		
Causes display to respond with its module number.				
<b>Response</b>	<b>Byte</b>	Module number, see Sample Module Type Responses for a partial list.		

Table 13: Sample Module Type Responses

## 7 Appendix

### 7.1 Command Summary

Available commands below include identifying number, required parameters, the returned response and an indication of whether settings are remembered always, never, or with remember set to on.

Table 14: Communication Command Summary

Name	Dec	Hex	ASCII	Parameters	Response	Remembered
Change Baud Rate	57	39	9	Byte	None	Always
Change I <sup>2</sup> C Slave Address	51	33	3	Byte	None	Always
Transmission Protocol Select	160	A0	á	Byte	None	Remember On
Set a Non-Standard Baud Rate	164	A4	ñ	Short	None	Always

Table 15: Text Command Summary

Name	Dec	Hex	ASCII	Parameters	Response	Remembered
Clear Screen	88	58	X	None	None	Never
Change the Start Up Screen	64	40	@	Byte[]	None	Always
Auto Scroll On	81	51	Q	None	None	Remember On
Auto Scroll Off	82	52	R	None	None	Remember On
Set Auto Line Wrap On	67	43	C	None	None	Remember On
Set Auto Line Wrap Off	68	44	D	None	None	Remember On
Set Cursor Position	71	47	G	Byte[2]	None	Never
Go Home	72	48	H	None	None	Never
Move Cursor Back	76	4C	L	None	None	Never
Move Cursor Forward	77	4D	M	None	None	Never
Underline Cursor On	74	4A	J	None	None	Remember On
Underline Cursor Off	75	4B	K	None	None	Remember On
Blinking Cursor On	83	53	S	None	None	Remember On
Blinking Cursor Off	84	54	T	None	None	Remember On



Table 16: Special Character Command Summary

Name	Dec	Hex	ASCII	Parameters	Response	Remembered
Create a Custom Character	78	4E	N	Byte[9]	None	Remember On
Save Custom Characters	193	C1	ñ	Byte[10]	None	Always
Load Custom Characters	192	C0		Byte	None	Never
Save Start Up Screen Custom Characters	194	C2		Byte[9]	None	Always
Initialize Medium Numbers	109	6D	m	None	None	Never
Place Medium Numbers	111	6F	o	Row, Col, Digit	None	Never
Initialize Horizontal Bar	104	68	h	None	None	Never
Place Horizontal Bar Graph	124	7C		Col, Row, Dir, Length	None	Never
Initialize Narrow Vertical Bar	115	73	s	None	None	Never
Initialize Wide Vertical Bar	118	76	v	None	None	Never
Place Vertical Bar	61	3D	=	Col, Length	None	Never

Table 17: General Purpose Output Command Summary

Name	Dec	Hex	ASCII	Parameters	Response	Remembered
General Purpose Output On	86	56	V	Byte	None	Never
General Purpose Output Off	87	57	W	Byte	None	Never
Set Start Up GPO State	195	C3		Byte[2]	None	Always

Table 18: Display Functions Command Summary

Name	Dec	Hex	ASCII	Parameters	Response	Remembered
Brightness On	66	42	B	Byte	None	Remember On
Brightness Off	70	46	F	None	None	Remember On
Set Brightness	153	99		Byte	None	Remember On
Set and Save Brightness	152	98		Byte	None	Always

Table 19: Data Security Command Summary

Name	Dec	Hex	ASCII	Parameters	Response	Remembered
Set Remember	147	93		Byte	None	Always
Set Data Lock	202, 245, 160	CA, F5, A0	, , 	Byte	None	Remember On
Set and Save Data Lock	203, 245, 160	CB, F5, A0	, , 	Byte	None	Always

Table 20: Miscellaneous Command Summary

Name	Dec	Hex	ASCII	Parameters	Response	Remembered
Write Customer Data	52	34	4	Byte[16]	None	Always
Read Customer Data	53	35	5	None	Byte[16]	Never
Read Version Number	54	36	6	None	Byte	Never
Read Module Type	55	37	7	None	Byte	Never

## 7.2 Character Sets

Upper 4bit Lower 4bit	LLLL	LLLH	LLHL	LLHH	LHLL	LHLH	LHHL	LHHH	HLLL	HLLH	HLHL	HLHH	HHLL	HHLH	HHHL	HHHH
LLLL	CG RAM (1)	☒	☒	☒	☒	☒	☒	☒	☒	☒	☒	☒	☒	☒	☒	☒
LLLL	CG RAM (2)	☒	☒	☒	☒	☒	☒	☒	☒	☒	☒	☒	☒	☒	☒	☒
LLHL	CG RAM (3)	☒	☒	☒	☒	☒	☒	☒	☒	☒	☒	☒	☒	☒	☒	☒
LLHH	CG RAM (4)	☒	☒	☒	☒	☒	☒	☒	☒	☒	☒	☒	☒	☒	☒	☒
LHLL	CG RAM (5)	☒	☒	☒	☒	☒	☒	☒	☒	☒	☒	☒	☒	☒	☒	☒
LHLH	CG RAM (6)	☒	☒	☒	☒	☒	☒	☒	☒	☒	☒	☒	☒	☒	☒	☒
LHHL	CG RAM (7)	☒	☒	☒	☒	☒	☒	☒	☒	☒	☒	☒	☒	☒	☒	☒
LHHH	CG RAM (8)	☒	☒	☒	☒	☒	☒	☒	☒	☒	☒	☒	☒	☒	☒	☒
HLLL	CG RAM (9)	☒	☒	☒	☒	☒	☒	☒	☒	☒	☒	☒	☒	☒	☒	☒
HLLH	CG RAM (10)	☒	☒	☒	☒	☒	☒	☒	☒	☒	☒	☒	☒	☒	☒	☒
HLHL	CG RAM (11)	☒	☒	☒	☒	☒	☒	☒	☒	☒	☒	☒	☒	☒	☒	☒
HLHH	CG RAM (12)	☒	☒	☒	☒	☒	☒	☒	☒	☒	☒	☒	☒	☒	☒	☒
HHLL	CG RAM (13)	☒	☒	☒	☒	☒	☒	☒	☒	☒	☒	☒	☒	☒	☒	☒
HHLH	CG RAM (14)	☒	☒	☒	☒	☒	☒	☒	☒	☒	☒	☒	☒	☒	☒	☒
HHHL	CG RAM (15)	☒	☒	☒	☒	☒	☒	☒	☒	☒	☒	☒	☒	☒	☒	☒
HHHH	CG RAM (16)	☒	☒	☒	☒	☒	☒	☒	☒	☒	☒	☒	☒	☒	☒	☒

Figure 9: English Japanese Character Set.

### 7.3 Block Diagram

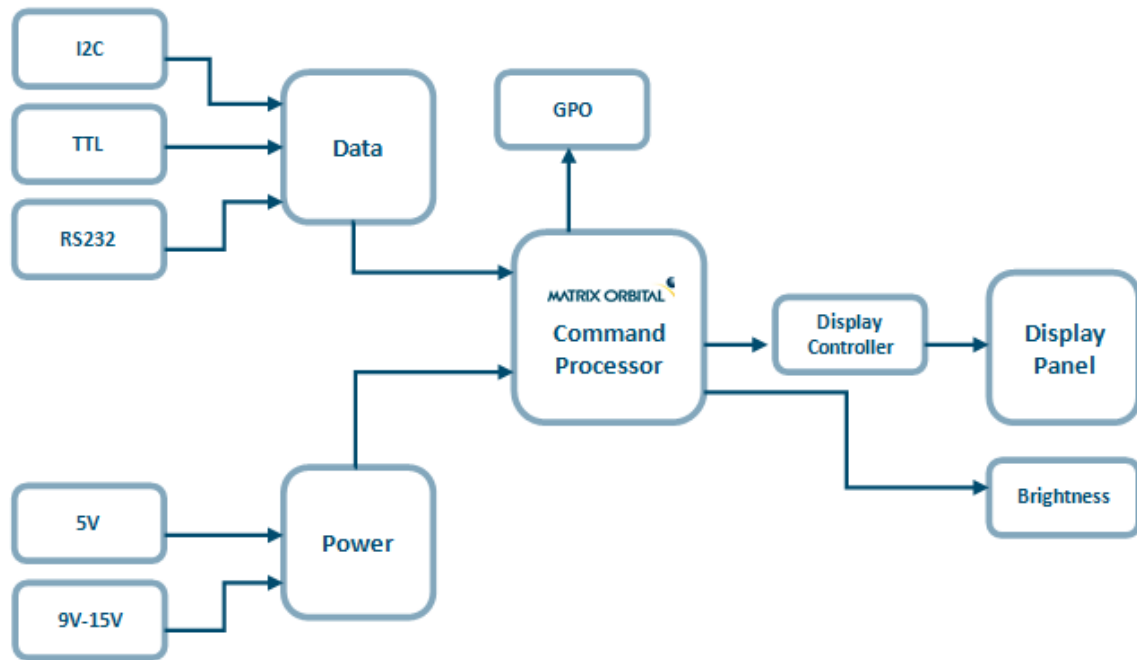

Figure 10: Functional Diagram

### 7.4 Environmental Specifications

Table 21: Environmental Limits

	OLED Standard	OLED Extended (-E)
Operating Temperature	-20°C to +70°C	-40°C to +80°C
Storage Temperature	-40°C to +80°C	-40°C to +80°C
Operating Relative Humidity	Maximum 90% non-condensing	

### 7.5 Electrical Tolerances

#### Current Consumption

Table 22: Current Consumption

Board	+	OLED	+	GPOs
45mA		27mA		20mA each maximum

Table 23: Brightness Current Draw

OLED
27mA

#### Input Voltage Specifications

Table 24: Voltage Specifications

Standard	Wide Voltage (-V)
4.75-5.25V	9.0-15.0V

# 7.6 Dimensional Drawings

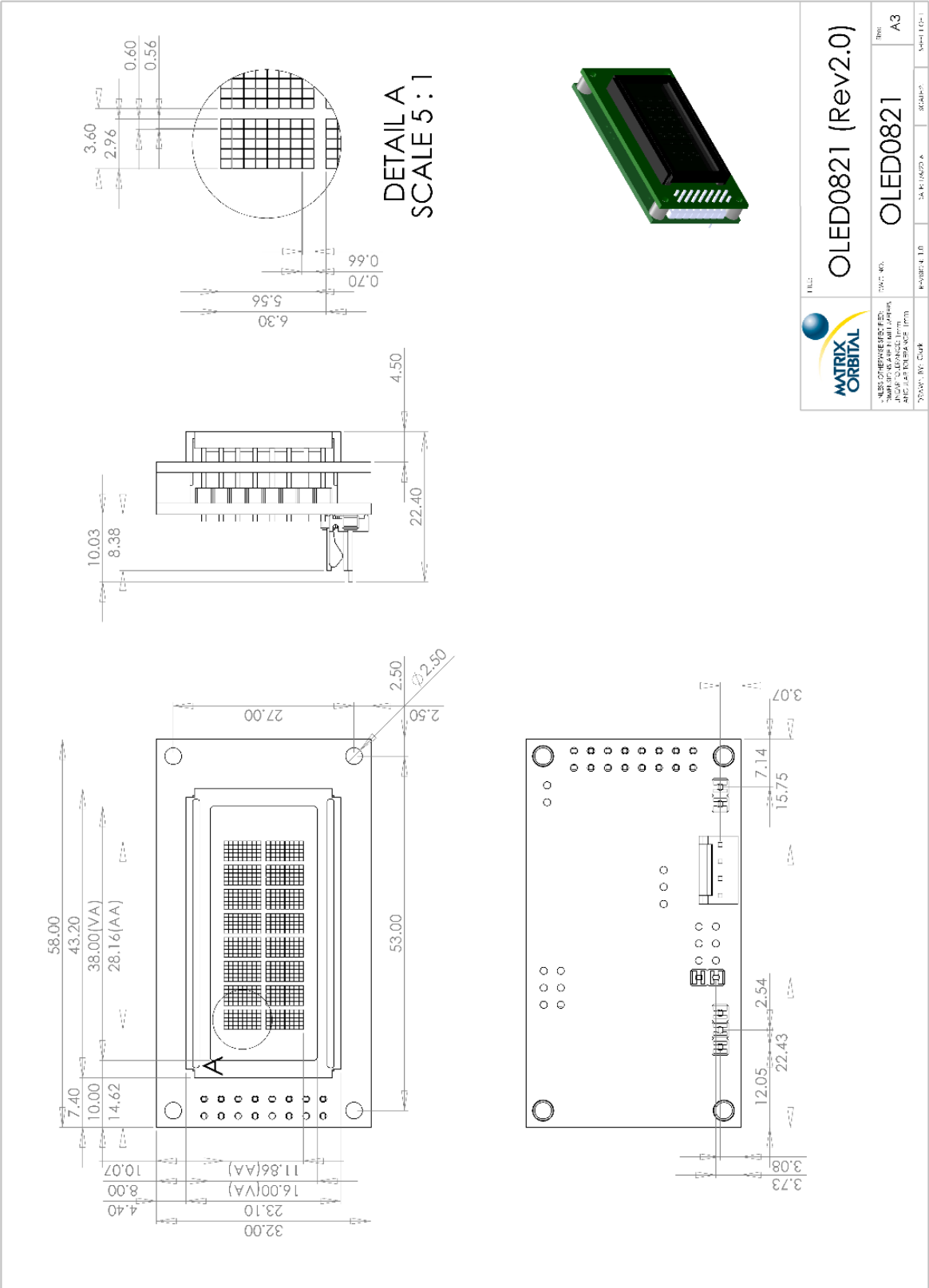

Figure 11: Display Dimensional Drawing

## 7.7 Optical Characteristics

Table 25: Display Optics

Module Size	58.00 x 32.00 x 22.40	mm
Viewing Area	38.0 x 16.0	mm
Active Area	28.16 x 11.86	mm
Character Size	2.96 x 5.56	mm
Character Pitch	3.60 x 6.30	mm
Pixel Size	0.56 x 0.66	mm
Pixel Pitch	0.60 x 0.70	mm
Viewing Angle	-80 to +80	°
Contrast Ratio	2000	
OLED Estimated Operating Lifetime	100,000	Hours

## 8 Ordering

### 8.1 Part Numbering Scheme

Table 26: Part Numbering Scheme

LCD	0821	-OB	-V	-E
1	2	3	4	5

### 8.2 Options

Table 27: Display Options



#	Designator	Options
1	Product Type	LCD: Liquid Crystal Display OLED: Organic Light Emitting Diode Display
2	Display Size	0821: 8 columns by 2 rows
3	Colour	OB: OLED Blue on Black
4	Voltage	*NP: Standard Voltage -V: Wide Voltage
5	Temperature	*NP: Standard -E: Extended Temperature

**\*Note:** NP means No Populate; skip this designator in the part number and move to the next option.

## 8.3 Accessories

### Communication

Table 28: Communication Accessories

SCCPC5V	Serial Communication/5V Power Cable	 A white cable with a red and black wire pair, featuring a DB9 connector on one end and a 5-pin header on the other.
BBC	Breadboard Cable	 A multi-colored ribbon cable with a 5-pin header on one end and a 5-pin header on the other.

## 9 Definitions

ASCII: American standard code for information interchange used to give standardized numeric codes to alphanumeric characters.

BPS: Bits per second, a measure of transmission speed.

GPO: General purpose output, used to control peripheral devices from a display.

GUI: Graphical user interface.

Hexadecimal: A base 16 number system utilizing symbols 0 through F to represent the values 0-15.

I<sup>2</sup>C: Inter-integrated circuit protocol uses clock and data lines to communicate short distances at slow speeds from a master to up to 128 addressable slave devices. A display is a slave device.

LSB: Least significant bit or byte in a transmission, the rightmost when read.

OLED: Organic light emitting diode display.

MSB: Most significant bit or byte in a transmission, the leftmost when read.

RS232: Recommended standard 232, a common serial protocol. A low level is -30V, a high is +30V.

SDA: Serial data line used to transfer data in I<sup>2</sup>C protocol. This open drain line should be pulled high through a resistor. Nominal values are between 1K and 10K Ω.

SCL: Serial clock line used to designate data bits in I<sup>2</sup>C protocol. This open drain line should be pulled high through a resistor. Nominal values are between 1K and 10K Ω.

TTL: Transistor-transistor logic applied to serial protocol. Low level is 0V while high logic is 5V.

## 10 Contact

### Sales

Phone: 403.229.2737

Email: [sales@matrixorbital.ca](mailto:sales@matrixorbital.ca)

### Support

Phone: 403.204.3750

Email: [support@matrixorbital.ca](mailto:support@matrixorbital.ca)

### Online

Purchasing: [www.matrixorbital.com](http://www.matrixorbital.com)

Support: [www.matrixorbital.ca](http://www.matrixorbital.ca)

Компания «Life Electronics» занимается поставками электронных компонентов импортного и отечественного производства от производителей и со складов крупных дистрибьюторов Европы, Америки и Азии.

С конца 2013 года компания активно расширяет линейку поставок компонентов по направлению коаксиальный кабель, кварцевые генераторы и конденсаторы (керамические, пленочные, электролитические), за счёт заключения дистрибьюторских договоров

Мы предлагаем:

- Конкурентоспособные цены и скидки постоянным клиентам.
- Специальные условия для постоянных клиентов.
- Подбор аналогов.
- Поставку компонентов в любых объемах, удовлетворяющих вашим потребностям.
- Приемлемые сроки поставки, возможна ускоренная поставка.
- Доставку товара в любую точку России и стран СНГ.
- Комплексную поставку.
- Работу по проектам и поставку образцов.
- Формирование склада под заказчика.
- Сертификаты соответствия на поставляемую продукцию (по желанию клиента).
- Тестирование поставляемой продукции.
- Поставку компонентов, требующих военную и космическую приемку.
- Входной контроль качества.
- Наличие сертификата ISO.

В составе нашей компании организован Конструкторский отдел, призванный помогать разработчикам, и инженерам.

Конструкторский отдел помогает осуществить:

- Регистрацию проекта у производителя компонентов.
- Техническую поддержку проекта.
- Защиту от снятия компонента с производства.
- Оценку стоимости проекта по компонентам.
- Изготовление тестовой платы монтаж и пусконаладочные работы.



Тел: +7 (812) 336 43 04 (многоканальный)

Email: [org@lifeelectronics.ru](mailto:org@lifeelectronics.ru)