

Standard Rectifier Module

| | |
|-------------------------|-------|
| 3~ Rectifier | |
| $V_{RRM} =$ | 800 V |
| $I_{DAV} =$ | 80 A |
| $I_{FSM} =$ | 600 A |

3~ Rectifier Bridge

Part number

VUO80-08NO1

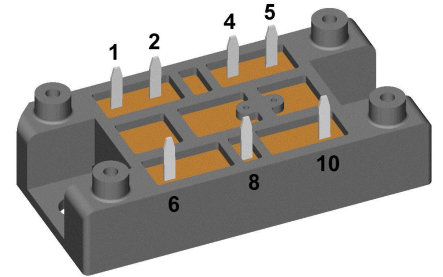

Backside: isolated

 E72873

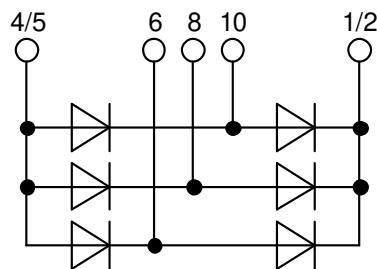

Features / Advantages:

- Package with DCB ceramic
- Improved temperature and power cycling
- Planar passivated chips
- Very low forward voltage drop
- Very low leakage current

Applications:

- Diode for main rectification
- For three phase bridge configurations
- Supplies for DC power equipment
- Input rectifiers for PWM inverter
- Battery DC power supplies
- Field supply for DC motors

Package: V1-A-Pack

- Isolation Voltage: 3600 V~
- Industry standard outline
- RoHS compliant
- Soldering pins for PCB mounting
- Height: 17 mm
- Base plate: DCB ceramic
- Reduced weight
- Advanced power cycling

Disclaimer Notice

Information furnished is believed to be accurate and reliable. However, users should independently evaluate the suitability of and test each product selected for their own applications. Littelfuse products are not designed for, and may not be used in, all applications. Read complete Disclaimer Notice at www.littelfuse.com/disclaimer-electronics.



| Rectifier | | | | Ratings | | | |
|------------|--|---|-------------|------------------------------|------|------|-------------------|
| Symbol | Definition | Conditions | | min. | typ. | max. | Unit |
| V_{RSM} | max. non-repetitive reverse blocking voltage | | | | | 900 | V |
| V_{RRM} | max. repetitive reverse blocking voltage | | | | | 800 | V |
| I_R | reverse current | $V_R = 800\text{ V}$ | | $T_{VJ} = 25^\circ\text{C}$ | | 40 | μA |
| | | $V_R = 800\text{ V}$ | | $T_{VJ} = 150^\circ\text{C}$ | | 1.5 | mA |
| V_F | forward voltage drop | $I_F = 30\text{ A}$ | | $T_{VJ} = 25^\circ\text{C}$ | | 1.14 | V |
| | | $I_F = 90\text{ A}$ | | | | 1.48 | V |
| | | $I_F = 30\text{ A}$ | | $T_{VJ} = 125^\circ\text{C}$ | | 1.06 | V |
| | | $I_F = 90\text{ A}$ | | | | 1.51 | V |
| I_{DAV} | bridge output current | $T_C = 110^\circ\text{C}$ | rectangular | $T_{VJ} = 150^\circ\text{C}$ | | 80 | A |
| V_{FO} | threshold voltage | } for power loss calculation only | | $T_{VJ} = 150^\circ\text{C}$ | | 0.81 | V |
| r_F | slope resistance | | | | | 7.8 | m Ω |
| R_{thJC} | thermal resistance junction to case | | | | | 1.1 | K/W |
| R_{thCH} | thermal resistance case to heatsink | | | | 0.3 | | K/W |
| P_{tot} | total power dissipation | | | $T_C = 25^\circ\text{C}$ | | 110 | W |
| I_{FSM} | max. forward surge current | $t = 10\text{ ms}; (50\text{ Hz}), \text{ sine}$ | | $T_{VJ} = 45^\circ\text{C}$ | | 600 | A |
| | | $t = 8,3\text{ ms}; (60\text{ Hz}), \text{ sine}$ | | $V_R = 0\text{ V}$ | | 650 | A |
| | | $t = 10\text{ ms}; (50\text{ Hz}), \text{ sine}$ | | $T_{VJ} = 150^\circ\text{C}$ | | 510 | A |
| | | $t = 8,3\text{ ms}; (60\text{ Hz}), \text{ sine}$ | | $V_R = 0\text{ V}$ | | 550 | A |
| I^2t | value for fusing | $t = 10\text{ ms}; (50\text{ Hz}), \text{ sine}$ | | $T_{VJ} = 45^\circ\text{C}$ | | 1.80 | kA ² s |
| | | $t = 8,3\text{ ms}; (60\text{ Hz}), \text{ sine}$ | | $V_R = 0\text{ V}$ | | 1.76 | kA ² s |
| | | $t = 10\text{ ms}; (50\text{ Hz}), \text{ sine}$ | | $T_{VJ} = 150^\circ\text{C}$ | | 1.30 | kA ² s |
| | | $t = 8,3\text{ ms}; (60\text{ Hz}), \text{ sine}$ | | $V_R = 0\text{ V}$ | | 1.26 | kA ² s |
| C_J | junction capacitance | $V_R = 400\text{ V}; f = 1\text{ MHz}$ | | $T_{VJ} = 25^\circ\text{C}$ | | 18 | pF |



| Package V1-A-Pack | | | | Ratings | | | |
|-------------------|-------------------------------|---|------|---------|------|------|--|
| Symbol | Definition | Conditions | min. | typ. | max. | Unit | |
| I_{RMS} | RMS current | per terminal | | | 100 | A | |
| T_{VJ} | virtual junction temperature | | -40 | | 150 | °C | |
| T_{op} | operation temperature | | -40 | | 125 | °C | |
| T_{stg} | storage temperature | | -40 | | 125 | °C | |
| Weight | | | | 37 | | g | |
| M_D | mounting torque | | 2 | | 2.5 | Nm | |
| $d_{Spp/App}$ | creepage distance on surface | terminal to terminal | 6.0 | | | mm | |
| $d_{Spb/Apb}$ | striking distance through air | terminal to backside | 12.0 | | | mm | |
| V_{ISOL} | isolation voltage | t = 1 second 50/60 Hz, RMS; $I_{ISOL} \leq 1$ mA | 3600 | | | V | |
| | | t = 1 minute | 3000 | | | V | |

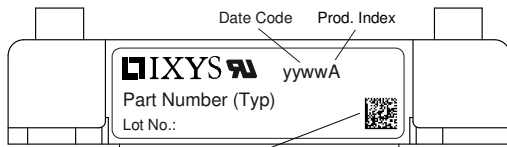

Data Matrix: Typ (1-19), DC+Prod.Index (20-25), FKT# (26-31)
leer (33), lld.# (33-36)

| Ordering | Ordering Number | Marking on Product | Delivery Mode | Quantity | Code No. |
|----------|-----------------|--------------------|---------------|----------|----------|
| Standard | VUO80-08NO1 | VUO80-08NO1 | Blister | 24 | 516847 |

Equivalent Circuits for Simulation

* on die level

$T_{VJ} = 150^{\circ}C$



Rectifier

| | | | |
|--------------|--------------------|------|----|
| $V_{0\ max}$ | threshold voltage | 0.81 | V |
| $R_{0\ max}$ | slope resistance * | 6.6 | mΩ |



Outlines V1-A-Pack

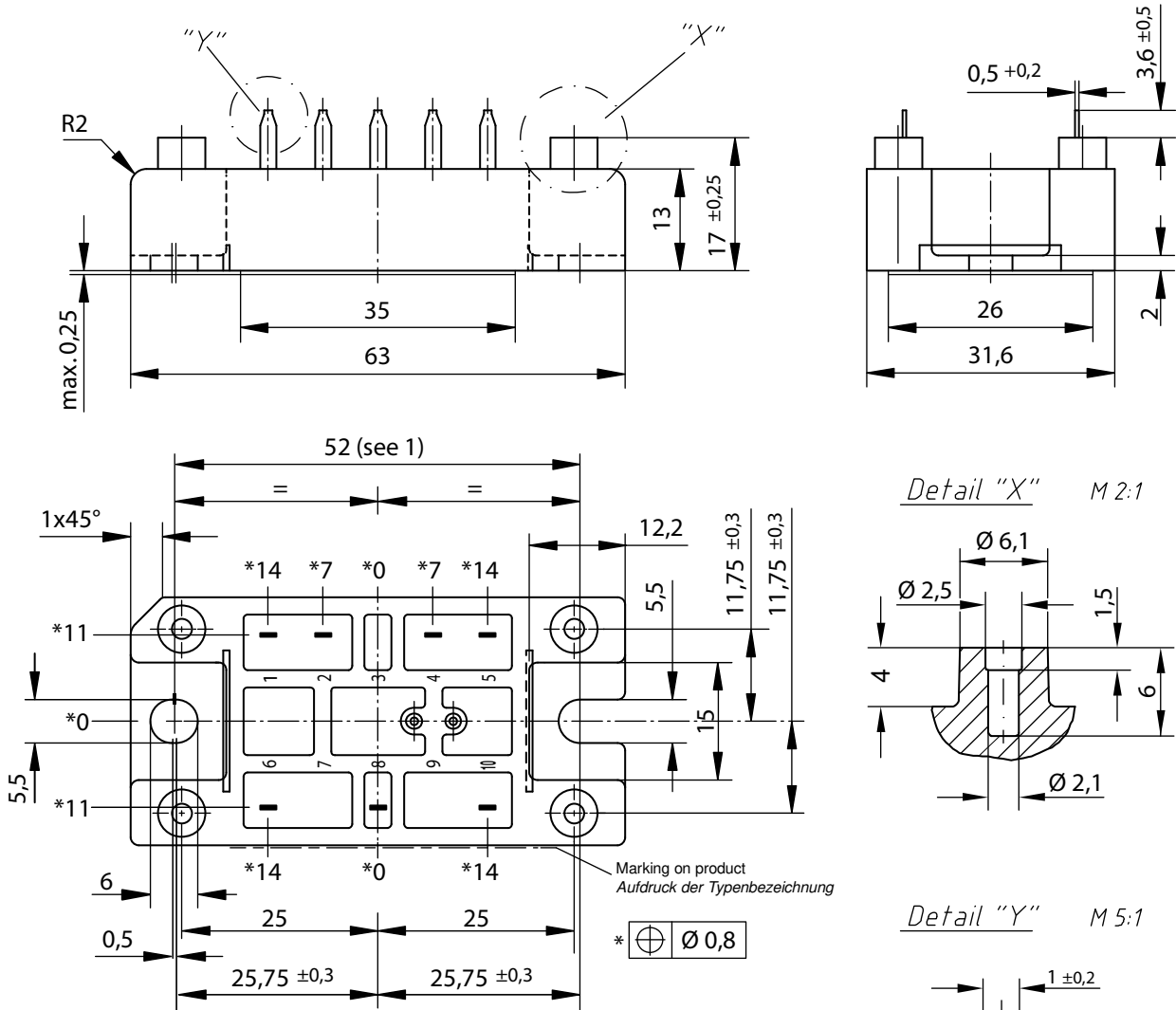

Remarks / Bemerkungen:

1. Nominal distance mounting screws on heat sink: 52 mm / Nennabstand Befestigungsschrauben auf Kühlkörper: 52 mm
 2. General tolerance / Allgemeintoleranz: DIN ISO 2768 -T1-c
 3. Surface treatment of pins: tin plated (Sn) in hot dip / Oberflächenbehandlung der Pins: verzinkt (Sn) im Tauchbad
 4. Detail X: EJOT PT® self-tapping screws (dimension K25) to be recommended for mounting on PCB ^L
selbstschneidende Schraube (Größe K25) empfohlen für die PCB-Montage
- Take care on the maximum screw length according to board thickness and the maximum hole depth of 6 mm^L
Bei der Wahl der Schraubenlänge die PCB-Dicke und die maximale Lochtiefe von 6mm beachten
- Recommended mounting torque: 1.5 Nm / Empfohlenes Drehmoment: 1.5 Nm

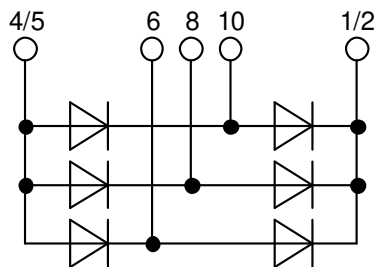



Rectifier

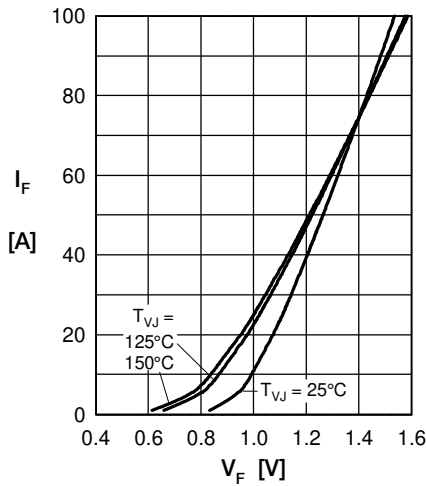

Fig. 1 Forward current vs. voltage drop per diode

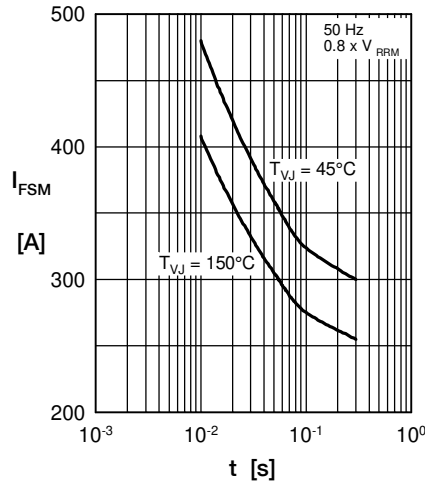

Fig. 2 Surge overload current vs. time per diode

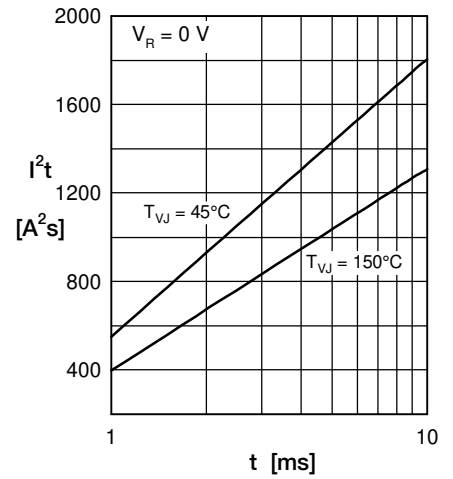

Fig. 3 I^2t vs. time per diode

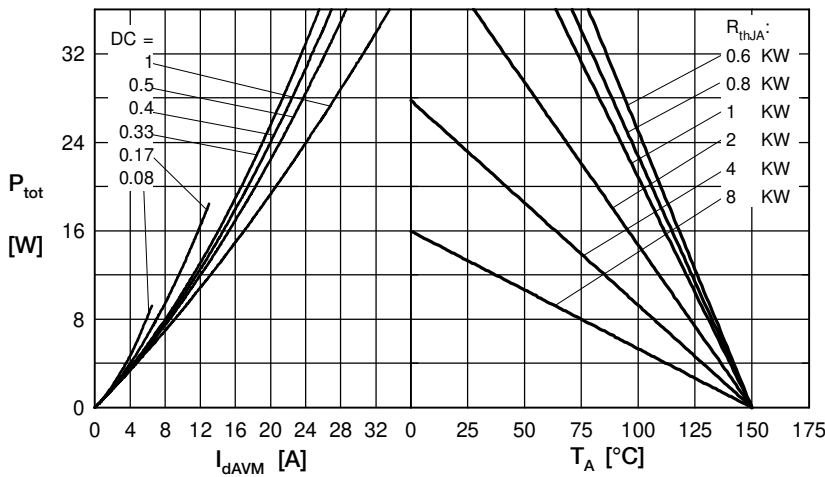

Fig. 4 Power dissipation vs. forward current and ambient temperature per diode

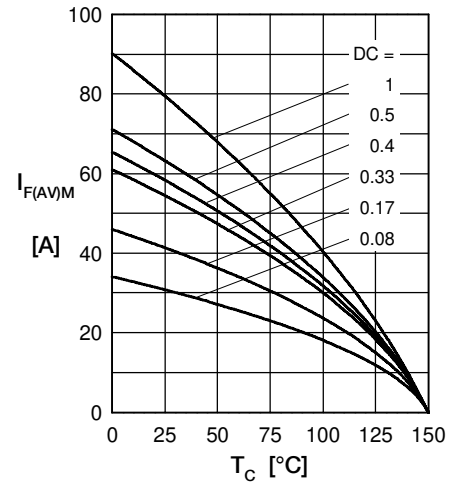

Fig. 5 Max. forward current vs. case temperature per diode

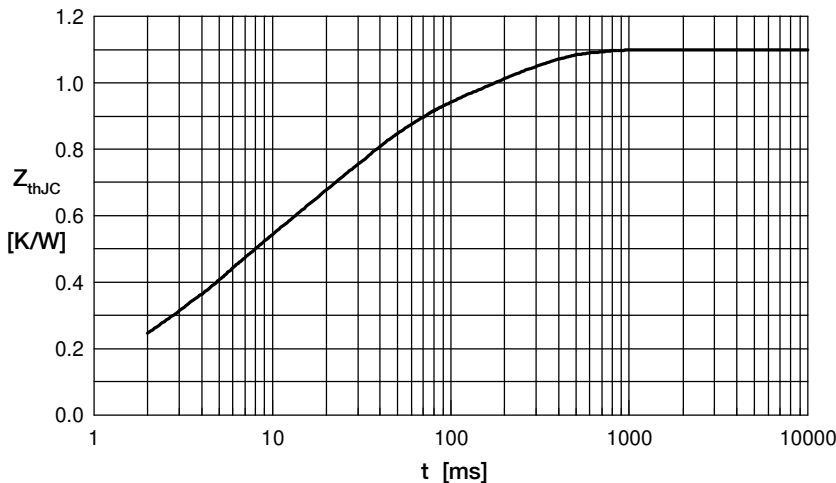

Fig. 6 Transient thermal impedance junction to case vs. time per diode

Constants for Z_{thJC} calculation:

| i | R_{th} (K/W) | t_i (s) |
|---|----------------|-----------|
| 1 | 0.0607 | 0.0004 |
| 2 | 0.1230 | 0.00256 |
| 3 | 0.2305 | 0.0045 |
| 4 | 0.4230 | 0.0242 |
| 5 | 0.2628 | 0.1800 |

Компания «Life Electronics» занимается поставками электронных компонентов импортного и отечественного производства от производителей и со складов крупных дистрибьюторов Европы, Америки и Азии.

С конца 2013 года компания активно расширяет линейку поставок компонентов по направлению коаксиальный кабель, кварцевые генераторы и конденсаторы (керамические, пленочные, электролитические), за счёт заключения дистрибьюторских договоров

Мы предлагаем:

- Конкурентоспособные цены и скидки постоянным клиентам.
- Специальные условия для постоянных клиентов.
- Подбор аналогов.
- Поставку компонентов в любых объемах, удовлетворяющих вашим потребностям.
- Приемлемые сроки поставки, возможна ускоренная поставка.
- Доставку товара в любую точку России и стран СНГ.
- Комплексную поставку.
- Работу по проектам и поставку образцов.
- Формирование склада под заказчика.
- Сертификаты соответствия на поставляемую продукцию (по желанию клиента).
- Тестирование поставляемой продукции.
- Поставку компонентов, требующих военную и космическую приемку.
- Входной контроль качества.
- Наличие сертификата ISO.

В составе нашей компании организован Конструкторский отдел, призванный помогать разработчикам, и инженерам.

Конструкторский отдел помогает осуществить:

- Регистрацию проекта у производителя компонентов.
- Техническую поддержку проекта.
- Защиту от снятия компонента с производства.
- Оценку стоимости проекта по компонентам.
- Изготовление тестовой платы монтаж и пусконаладочные работы.



Тел: +7 (812) 336 43 04 (многоканальный)

Email: org@lifeelectronics.ru