

List of "SFW__R-3/4STE1LF" customer document

DOCUMENT NO.	LIST
SC-STW11	SPEC.
JSA95860	CAT.NO.TABLE FOR 1mm SPACING SMT CONNECTOR (SFW__R-3/4ST__LF)
JSA95861	1mm SPACING SMT CONNECTOR (SFW__R-3ST__LF)
JSA95862	1mm SPACING SMT CONNECTOR (SFW__R-4ST__LF)
JSA95863	CAT.NO.TABLE FOR PLASTIC TAPE PACKAGED 1mm SPACING SMT CONNECTOR (SFW__R-3/4STE1LF)
JSA95864	PLASTIC TAPE PACKAGED 1mm SPACING SMT CONNECTOR (SFW__R-3STE1LF)
JSA95865	PLASTIC TAPE PACKAGED 1mm SPACING SMT CONNECTOR (SFW__R-4STE1LF)
JSA93212	RECOMMENDED CABLE (FPC) (SFW__R-3/4ST__)
JSA93213 C	RECOMMENDED CABLE (FFC) (SFW__R-3/4ST__)
GS-20-130	HANDLING PROCEDURES

NOTE

1. A C symbol will be next to any dimension, view, or note which has been modified with the current drawing revision.

mat'l. code -				surface 58 / tolerance ISO 1302 <input checked="" type="checkbox"/> ISO 406 ISO 1101		projection 		product family 58RF		CODE JP	
ltr				tolerances unless otherwise specified		mm 		title			
A	J05-0055	H.T	05-02-04	angles linear		scale \times		1mm SPACING FPC CONNECTOR DOCUMENT LIST (Cat. No. : SFW__R-3/4STE1LF)			
B	J06-0398	H.T	06-09-26					dwg no		sheet 1 of 1	
C	S09-0180	DGOH	09-05-28					JSA 96338		A4	
D	J09-0363	M.Y	2009-10-8	dr	M.YAMAGUCHI	2009-10-27	type Product Customer Drawing				
E	J09-0380	M.Y	2009-10-27	engr	M.YAMAGUCHI	2009-10-27	Rev. E				
				chr	S. Yamaguchi	2009-10-27					
				appd	S. Yamaguchi	2009-10-27					
sheet index	revision sheet	E	1								

CAT. NO. & DIMENSIONS

NO. OF CONTACTS (n)	CAT. NO.	DIMENSIONS (NOTE2)			
		A ± 0.2	B ± 0.2	C ± 0.2	D ± 0.1
4	SFW4R-3/4ST__LF	9.8	8.6	3.0	3.92
5	SFW5R-3/4ST__LF	10.8	9.6	4.0	4.92
6	SFW6R-3/4ST__LF	11.8	10.6	5.0	5.92
7	SFW7R-3/4ST__LF	12.8	11.6	6.0	6.92
8	SFW8R-3/4ST__LF	13.8	12.6	7.0	7.92
9	SFW9R-3/4ST__LF	14.8	13.6	8.0	8.92
10	SFW10R-3/4ST__LF	15.8	14.6	9.0	9.92
11	SFW11R-3/4ST__LF	16.8	15.6	10.0	10.92
12	SFW12R-3/4ST__LF	17.8	16.6	11.0	11.92
13	SFW13R-3/4ST__LF	18.8	17.6	12.0	12.92
14	SFW14R-3/4ST__LF	19.8	18.6	13.0	13.92
15	SFW15R-3/4ST__LF	20.8	19.6	14.0	14.92
16	SFW16R-3/4ST__LF	21.8	20.6	15.0	15.92
17	SFW17R-3/4ST__LF	22.8	21.6	16.0	16.92
18	SFW18R-3/4ST__LF	23.8	22.6	17.0	17.92
19	SFW19R-3/4ST__LF	24.8	23.6	18.0	18.92
20	SFW20R-3/4ST__LF	25.8	24.6	19.0	19.92
21	SFW21R-3/4ST__LF	26.8	25.6	20.0	20.92
22	SFW22R-3/4ST__LF	27.8	26.6	21.0	21.92
23	SFW23R-3/4ST__LF	28.8	27.6	22.0	22.92
24	SFW24R-3/4ST__LF	29.8	28.6	23.0	23.92
25	SFW25R-3/4ST__LF	30.8	29.6	24.0	24.92
26	SFW26R-3/4ST__LF	31.8	30.6	25.0	25.92
27	SFW27R-3/4ST__LF	32.8	31.6	26.0	26.92
28	SFW28R-3/4ST__LF	33.8	32.6	27.0	27.92
29	SFW29R-3/4ST__LF	34.8	33.6	28.0	28.92
30	SFW30R-3/4ST__LF	35.8	34.6	29.0	29.92

CAT. NO. SFW (n) R - 3 ST ___ LF

SERIES NAME

NO. OF CONTACTS

RIGHT ANGLE TYPE

FOR FPC/FFC, WITH CABLE LOCK MECHANISM

CONTACT DIRECTION
3. LOWER CONTACT TYPE
4. UPPER CONTACT TYPE

FOR AUTOMATIC MOUNTING (SMT)

PACKAGE STYLE

LEAD FREE

NOTES

1. THIS PRODUCT IS THE CONNECTOR USED FOR FPC/FFC AND COPE WITH AUTOMATIC MOUNTING (SMT).
2. SEE PART DRAWINGS FOR DIMENSIONS A~D.
3. THIS PRODUCT IS THE CONNECTOR WITH CABLE LOCK MECHANISM.

mat'l. code				surface 58 / ISO 1302		tolerance ISO 406 / ISO 1101		projection		product family 58RF		CODE JP	
ltr		ecn no		dr		date		tolerances unless otherwise specified		title		sheet 1 of 1 size	
AA		J05-0055		H.T		2/4/'05		angles linear		CAT NO. TABLE FOR 1mm SPACING SMT CONNECTOR (Cat. No. SFW__R-3/4ST__LF)		A4	
AB		J06-0398		H.T		9/26/'06		mm		dwg no		JSA 95860	
AC		J09-0363		M.Y		2009-10-8		scale X		type		Product Customer Drawing	
sheet index		revision sheet		AC		1		FCJ		Rev. AC			

SC_SFW11 JSA95861 95862 95863 95864 95865 93212 93213 Form: A4

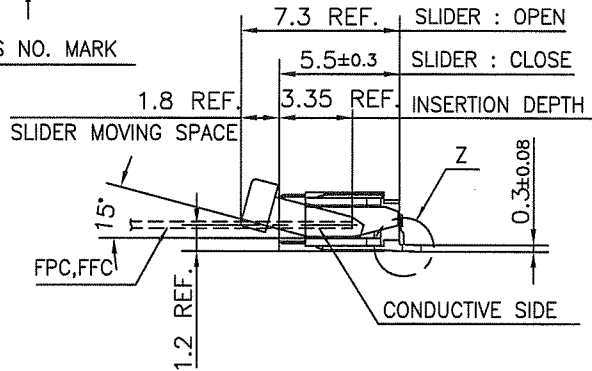
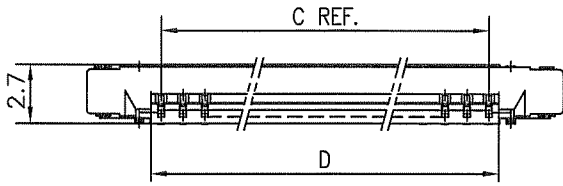

PT. NO.	PARTS NAME	MATERIAL	Q'TY	NOTE
1	HOUSING	PPS RESIN GLASS REINFORCED (UL94V-0)	1	COLOR : BLACK
2	SLIDER		1	COLOR : BROWN
3	CONTACT	PHOSPHOR BRONZE	n	PLATING : TIN
4	MOUNTING PLATE		2	

n : NO. OF CONTACTS

RECOMMENDED PC BOARD LAYOUT (COMPONENT SIDE)

BASIC PATTERN NO.1 CONTACT POSITION

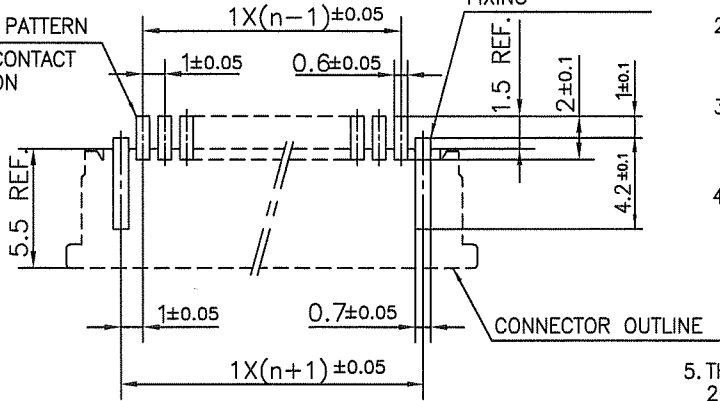

NOTES

1. THIS PRODUCT IS THE CONNECTOR USED FOR FPC/FFC AND COPEs WITH AUTOMATIC MOUNTING (SMT).
2. FLATNESS FOR CONTACT TERMINAL HOUSING MUST BE WITHIN TOLERANCE IN Z PORTION DETAILED DRAWING.
3. THIS PRODUCT IS LOWER CONTACT TYPE CONNECTOR WITH CABLE LOCK MECHANISM.
4. THIS PRODUCT MEETS EUROPEAN UNION DIRECTIVES AND OTHER COUNTRY REGULATIONS AS DESCRIBED IN GS-22-008
5. THE HOUSING WILL WITHSTAND EXPOSURE TO 260°C PEAK TEMPERATURE FOR 10 SECONDS IN A REFLOW SOLDERING OVEN.



FCIconnect.com

Copyright FCI.

mat'l. code				surface 58 / tolerance ISO 1302 ✓ ISO 406 ISO 1101		projection		product family 58RF		CODE JP		
ltr	ecn no	dr	date	tolerances unless otherwise specified		mm		title				
AA	J04-0180	H.T	7/2/'04	±0.2		mm		1mm SPACING SMT CONNECTOR (Cat. No. SFW__R-3ST__LF)				
AB	J05-0055	H.T	2/4/'05	linear		mm		scale X				
AC	J05-0736	H.T	10/28/'05			mm		dwg no sheet 1 of 1 size				
AD	J06-0398	H.T	9/26/'06	dr	M.YAMASHITA	2009-10-8	FCI		JSA 95861			A4
AE	J09-0363	M.Y	2009-10-8	enr	M.YAMASHITA	2009-10-8			type Product Customer Drawing			
				chr	S. Witek	2009-10-8						
				appd	S. Chohan	2009-10-8						
sheet index		revision AE		sheet 1						Rev. AE		

SC_SFW11 JSA95860 form: A4



PT. NO.	PARTS NAME	MATERIAL	Q'TY	NOTE
1	HOUSING	PPS RESIN GLASS REINFORCED (UL94V-0)	1	COLOR : BLACK
2	SLIDER		1	COLOR : BROWN
3	CONTACT	PHOSPHOR BRONZE	n	PLATING : TIN
4	MOUNTING PLATE		2	

n : NO. OF CONTACTS

RECOMMENDED PC BOARD LAYOUT
(COMPONENT SIDE)

BASIC PATTERN

NO.1 CONTACT POSITION



NOTES

1. THIS PRODUCT IS THE CONNECTOR USED FOR FPC/FFC AND COPES WITH AUTOMATIC MOUNTING (SMT).
2. FLATNESS FOR CONTACT TERMINAL HOUSING MUST BE WITHIN TOLERANCE IN Z PORTION DETAILED DRAWING.
3. THIS PRODUCT IS UPPER CONTACT TYPE CONNECTOR WITH CABLE LOCK MECHANISM.
4. THIS PRODUCT MEETS EUROPEAN UNION DIRECTIVES AND OTHER COUNTRY REGULATIONS AS DESCRIBED IN GS-22-008
5. THE HOUSING WILL WITHSTAND EXPOSURE TO 260°C PEAK TEMPERATURE FOR 10 SECONDS IN A REFLOW SOLDERING OVEN.

mat'l. code				surface 58 / tolerance ISO 1302 ✓ / ISO 406 / ISO 1101		projection		product family 58RF		CODE JP			
ltr ecn no dr date				tolerances unless otherwise specified		mm		title					
AA J04-0180 H.T 7/2/'04				angles linear ±0.2		mm		1mm SPACING SMT CONNECTOR					
AB J05-0055 H.T 2/4/'05						mm		(Cat. No. SFW__R-4ST__LF)					
AC J05-0736 H.T 10/28/'05						scale X							
AD J06-0398 H.T 9/26/'06				dr H. YAMASAKI 2007-10-8		FCJ		dwg no sheet 1 of 1 size					
AE J09-0363 M.Y 2009-10-8				enr H. YAMASAKI 2007-10-8				JSA 95862		A4			
				chr S. Nishida 2007-10-8				type Product Customer Drawing					
				appd S. Andaman 2009-10-8									
sheet index		revision sheet		AE 1						Rev. AE			

SC_SFW11 JSA95860 form: A4

CAT. NO. & DIMENSIONS

NO. OF CONTACTS (n)	CAT. NO. (NOTE2)	DIMENSIONS (NOTE3)		
		E ± 5	F ± 0.3	G ± 0.1
4	SFW4R-3/4STE1 LF	20.4	16	—
5	SFW5R-3/4STE1 LF	28.4	24	—
6	SFW6R-3/4STE1 LF	28.4	24	—
7	SFW7R-3/4STE1 LF	28.4	24	—
8	SFW8R-3/4STE1 LF	28.4	24	—
9	SFW9R-3/4STE1 LF	28.4	24	—
10	SFW10R-3/4STE1 LF	28.4	24	—
11	SFW11R-3/4STE1 LF	28.4	24	—
12	SFW12R-3/4STE1 LF	28.4	24	—
13	SFW13R-3/4STE1 LF	36.4	32	28.4
14	SFW14R-3/4STE1 LF	36.4	32	28.4
15	SFW15R-3/4STE1 LF	36.4	32	28.4
16	SFW16R-3/4STE1 LF	36.4	32	28.4
17	SFW17R-3/4STE1 LF	48.4	44	40.4
18	SFW18R-3/4STE1 LF	48.4	44	40.4
19	SFW19R-3/4STE1 LF	48.4	44	40.4
20	SFW20R-3/4STE1 LF	48.4	44	40.4
21	SFW21R-3/4STE1 LF	48.4	44	40.4
22	SFW22R-3/4STE1 LF	48.4	44	40.4
23	SFW23R-3/4STE1 LF	48.4	44	40.4
24	SFW24R-3/4STE1 LF	48.4	44	40.4
25	SFW25R-3/4STE1 LF	48.4	44	40.4
26	SFW26R-3/4STE1 LF	48.4	44	40.4
27	SFW27R-3/4STE1 LF	48.4	44	40.4
28	SFW28R-3/4STE1 LF	60.4	56	52.4
29	SFW29R-3/4STE1 LF	60.4	56	52.4
30	SFW30R-3/4STE1 LF	60.4	56	52.4

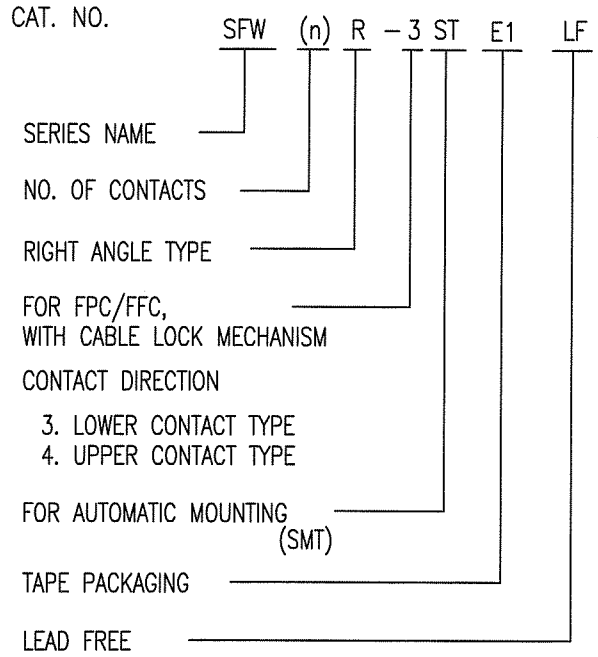

NOTES

1. THIS PRODUCT IS THE CONNECTOR USED FOR FPC/FFC AND COPES WITH AUTOMATIC MOUNTING (SMT).
2. THIS CATALOG NO. INDICATES PLASTIC TAPE PACKAGED CONNECTOR.
3. SEE PART DRAWINGS FOR DIMENSIONS E~G.
4. THIS PRODUCT IS THE CONNECTOR WITH CABLE LOCK MECHANISM.

mat'l. code				surface 58 / tolerance ISO 1302 / ISO 406 / ISO 1101		projection		product family 58RF		CODE JP	
litr ecn no dr date				tolerances unless otherwise specified		mm		title			
AA J05-0055 H.T 2/4/05				angles linear		scale X		CAT NO. TABLE FOR PLASTIC TAPE PACKAGED 1mm SPACING SMT CONNECTOR (Cat. No. SFW__R-3/4STE1 LF)			
AB J06-0398 H.T 9/26/06				dr M.YAHASHITA 2009-10-8		FCJ		dwg no sheet 1 of 1 size		A4	
AC J09-0363 M.Y 2009-10-8				enr M.YAHASHITA 2009-10-8		type Product Customer Drawing					
sheet revision AC				chr S. Nishida 2009-10-8				Rev. AC			
index sheet 1				appd J. Andam 2009-10-8							

SC_SFW11 JSA95860 95864 95865 form: A4



PT. NO.	PARTS NAME	CAT. NO.	MATERIAL	Q'TY	NOTE
1	REEL	_____	CARDBOARD	1	COLOR:WHITE
2	PLASTIC (EMBOSS) TAPE	_____	PET	_____	COLOR:TRANSPARENCY
3	COVER	_____	POLYESTER	_____	COLOR:TRANSPARENCY
4	CONNECTOR	SFW__R-3ST_LF	SEE ATTACHED DWG.	2000	LOWER CONTACT TYPE

NOTES

1. THIS IS PLASTIC TAPE PACKAGED CONNECTOR WITH CABLE LOCK MECHANISM USED FOR FPC/FFC AND COPES WITH AUTOMATIC MOUNTING (SMT).
2. SEE JIS C 0806 (PACKING OF ELECTRONIC COMPONENTS ON CONTINUOUS TAPES (SURFACE MOUNTING DEVICES)) FOR SHAPE AND DIMENSIONS OF PLASTIC (EMBOSS) TAPE AND REEL.
3. E DIMENSION IS PORTION OF THE CORE.

mat'l. code		surface ISO 1302		tolerance ISO 406 ISO 1101		projection		product family 58RF		CODE JP	
ltr ecn no dr date		tolerances unless otherwise specified		angles linear		mm		title			
AA J05-0055 H.T 2/4/'05		±5						PLASTIC TAPE PACKAGED 1mm SPACING SMT CONNECTOR (Cat. No. SFW__R-3STE1 LF)			
AB J06-0398 H.T 9/26/'06		±5'				scale X		dwg no sheet 1 of 1 size			
AC J09-0363 M.Y 2009-10-8						FCJ		JSA 95864 A4			
		dr H.YAMASHITA 2009-10-8						type Product Customer Drawing			
		enr H.YAMASHITA 2009-10-8						Rev. AC			
		chr S. W. H. L. 2009-10-8									
		appd S. Cholan 2009-10-8									
sheet index		revision sheet 1									

SC_SFW11 JSA95863 form: A4



PT. NO.	PARTS NAME	CAT. NO.	MATERIAL	Q'TY	NOTE
1	REEL	—	CARDBOARD	1	COLOR:WHITE
2	PLASTIC (EMBOSS) TAPE	—	PET	—	COLOR:TRANSPARENCY
3	COVER	—	POLYESTER	—	COLOR:TRANSPARENCY
4	CONNECTOR	SFW_R-4ST_LF	SEE ATTACHED DWG.	2000	UPPER CONTACT TYPE

NOTES

1. THIS IS PLASTIC TAPE PACKAGED CONNECTOR WITH CABLE LOCK MECHANISM USED FOR FPC/FFC AND COPEs WITH AUTOMATIC MOUNTING (SMT).
2. SEE JIS C 0806 (PACKING OF ELECTRONIC COMPONENTS ON CONTINUOUS TAPES (SURFACE MOUNTING DEVICES)) FOR SHAPE AND DIMENSIONS OF PLASTIC (EMBOSS) TAPE AND REEL.
3. E DIMENSION IS PORTION OF THE CORE.

mat'l. code		surface ISO 1302		tolerance ISO 406 ISO 1101		projection		product family 58RF		CODE JP	
ltr	ecn no	dr	date	tolerances unless otherwise specified		mm		title			
AA	J05-0055	H.T	2/4/'05	±5		mm		PLASTIC TAPE PACKAGED 1mm SPACING SMT CONNECTOR (Cat. No. SFW_R-4STE1 LF)			
AB	J06-0398	H.T	9/26/'06	angles	linear	scale X		dwg no sheet 1 of 1 size			
AC	J09-0363	M.Y	2009-10-8	±5'		FCJ		JSA 95865 A4			
sheet index		revision sheet	AC	dr M.YAMASHITA 2009-10-8		engr M.YAMASHITA 2009-10-8		chr S. Kishida 2009-10-8		appd S. Gudam 2009-10-8	
1		1						type Product Customer Drawing		Rev. AC	

SC_SFW11 JSA95863 form: A4



FCIconnect.com

Copyright FCI.



RECOMMENDED CABLE (FPC)



PT. NO.	PARTS NAME	MATERIAL	THICKNESS (um)
1	BASE FILM	POLYIMIDE OR POLYESTER OR EQUAL	25
2	CONDUCTOR	COPPER FOIL(PLATING : SOLDER 1um MIN.)	35
3	OVERLAY	POLYIMIDE OR POLYESTER OR EQUAL	—
4	SUPPORTING TAPE	POLYESTER OR POLYIMIDE OR EQUAL	188

- NOTES
1. THIS DRAWING INDICATES THE FPC USED THE CONNECTOR WITH CABLE LOCK MECHANISM.
 2. NO BURR AT EACH PORTION.
 3. NO PEELING IN COMMON USE.
 4. TOTAL THICKNESS LIMIT OF EACH MATERIAL (INCLUDING ADHESIVE AGENT) IS SPECIFIED.
 5. THIS DIMENSION INDICATES THE RANGE FOR 0.7 ±0.08 CONDUCTOR WIDTH.

mat'l. code				surface 58 / tolerance ISO 1302 ✓ / ISO 406 / ISO 1101		projection		product family 58RF		CODE JP	
ltr ecn no dr date				tolerances unless otherwise specified		mm		title			
1 — — 9/10/'98				angles linear		mm		RECOMMENDED CABLE (Cat. No. SFW_R-3/4_)			
AA J05-0055 H.T 2/4/'05						scale X		dwg no sheet 1 of 1 size			
AB J06-0398 H.T 9/26/'06						FCJ		JSA 93212 A4			
AC J09-0363 M.Y 2009-10-8				dr HYAMASHITA 2009-10-8				type Product Customer Drawing			
				enrg HYAMASHITA 2009-10-8							
				chr S. W. 2009-10-8							
				appd S. A. 2009-10-8							
sheet index		revision AC								Rev. AC	
		sheet 1									

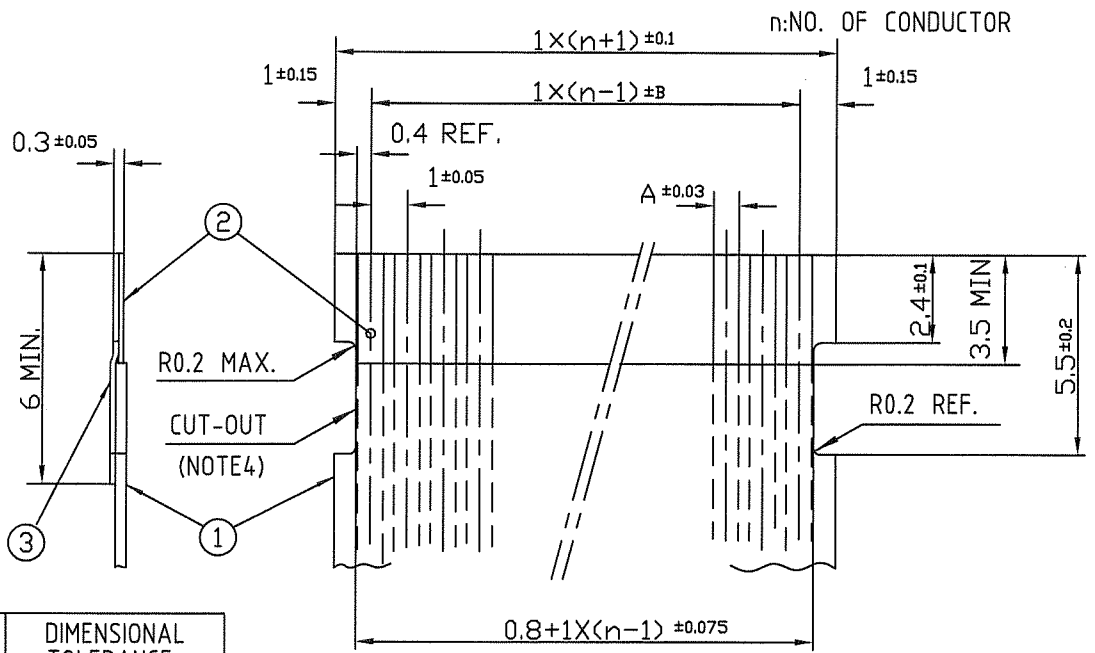

RECOMMENDED CABLE (FFC)



KIND OF FFC (NOTES)	DIMENSIONAL TOLERANCE	
	A	B
1	0.7	0.1
2	0.6	0.07

PT. NO.	PARTS NAME	MATERIAL	NOTE
1	INSULATOR	FLAME RESISTING POLYESTER OR EQUAL	_____
2	CONDUCTOR	COPPER FOIL	PLATING: TIN OR SOLDER 1um MIN.
3	SUPPORTING TAPE	FLAME RESISTING POLYESTER OR EQUAL	_____

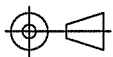
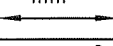
- NOTES
1. THIS DRAWING INDICATES THE FFC USED THE CONNECTOR WITH CABLE LOCK MECHANISM.
 2. NO BURR AT EACH PORTION.
 3. NO PEELING IN COMMON USE.
 4. THERE IS A POSSIBILITY THAT THE CAT-OUT CROSSES THE CONDUCTOR BECAUSE OF DIMENSIONAL TOLERANCE.
 5. EITHER KIND1 OR KIND2 OF FFC CAN ACCEPT DIMENSIONAL TOLERANCE a AND b.

mat'l. code				surface 58 / tolerance ISO 1302 ✓ / ISO 406 / ISO 1101		projection 		product family 58RF		CODE JP	
ltr ecn no dr date				tolerances unless otherwise specified				title RECOMMENDED CABLE (Cat. No. SFW_R-3/4_)			
AA J05-0055 H.T 2/4/'05				angles linear		scale X		dwg no JSA 93213		sheet 1 of 1 size A4	
AB J06-0398 H.T 9/26/'06								type Product Customer Drawing			
AC J09-0363 M.Y 2009-10-8				dr H. YAMASHITA 2009-10-8				Rev. AC			
				enr H. YAMASHITA 2009-10-8							
				chr S. W. 2009-10-8							
				appd S. Anderson 2009-10-8							
sheet index		revision sheet 1									



FCJconnect.com

Copyright FCI.

Компания «Life Electronics» занимается поставками электронных компонентов импортного и отечественного производства от производителей и со складов крупных дистрибьюторов Европы, Америки и Азии.

С конца 2013 года компания активно расширяет линейку поставок компонентов по направлению коаксиальный кабель, кварцевые генераторы и конденсаторы (керамические, пленочные, электролитические), за счёт заключения дистрибьюторских договоров

Мы предлагаем:

- Конкурентоспособные цены и скидки постоянным клиентам.
- Специальные условия для постоянных клиентов.
- Подбор аналогов.
- Поставку компонентов в любых объемах, удовлетворяющих вашим потребностям.
- Приемлемые сроки поставки, возможна ускоренная поставка.
- Доставку товара в любую точку России и стран СНГ.
- Комплексную поставку.
- Работу по проектам и поставку образцов.
- Формирование склада под заказчика.
- Сертификаты соответствия на поставляемую продукцию (по желанию клиента).
- Тестирование поставляемой продукции.
- Поставку компонентов, требующих военную и космическую приемку.
- Входной контроль качества.
- Наличие сертификата ISO.

В составе нашей компании организован Конструкторский отдел, призванный помогать разработчикам, и инженерам.

Конструкторский отдел помогает осуществить:

- Регистрацию проекта у производителя компонентов.
- Техническую поддержку проекта.
- Защиту от снятия компонента с производства.
- Оценку стоимости проекта по компонентам.
- Изготовление тестовой платы монтаж и пусконаладочные работы.



Тел: +7 (812) 336 43 04 (многоканальный)

Email: org@lifeelectronics.ru