



- Square and rectangular caps
- 6mm x 12.3mm; 14.9mm x 14.9mm; 15.1mm x 15.1mm
- h=16.9mm; 14.6mm; 14.5mm
- Material: ABS
- Temp. Range: -40/+65°C

All dimensions in mm

Tolerances -/+0.2mm

DIMENSIONS

(TH) + 16300



(TH) + 16700

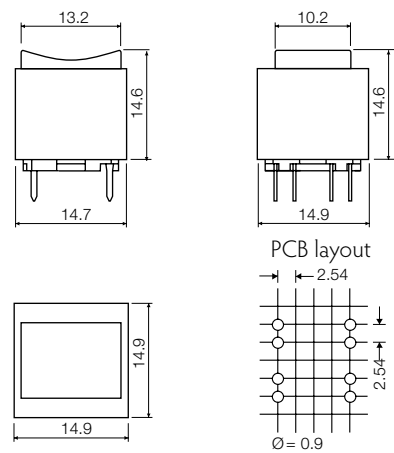

(TH) + 16800



NON-ILLUMINATED- HOW TO ORDER

Switch

1 5 4

- 15401 mom. silver
- 15402 mom. gold.
- 15420 silent gold
- 15451 lat. silver.
- 15452 lat. gold

Cap and color code

+ 1 6 3 0 0



- 00 blue
- 02 green
- 03 grey
- 04 yellow
- 06 white
- 08 red
- 09 black

Switch

1 5 4



+

Cap

1 6 7 0 0



- 00 blue
- 02 green
- 03 grey

- 04 yellow
- 06 white
- 08 red

- 09 black

Ordering example: 15451+1630003 OR 15401+1670008

Please see colour codes, updates of products and changes of specifications on www.mec.dk

- Square solution
- 15.1mm x 15.1mm
- h=16.0 mm
- Material: ABS
- Temp. Range: -40/+65°C



All dimensions in mm

Tolerances +/-0.2mm

DIMENSIONS

(TH) + 16310

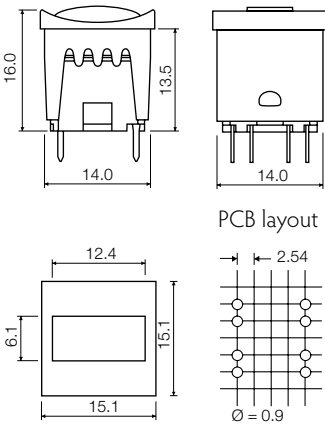

(TH w/LED) + 16311



(TH w/LED) + 16312



(TH w/4 LED) + 16315



NON-ILLUMINATED – HOW TO ORDER

Switch

1 5 4

- 15401 mom. silver
- 15402 mom. gold.
- 15420 silent gold
- 15451 lat. silver
- 15452 lat. gold

+

Cap

1 6 3 0 0

- 00 blue
- 02 green
- 03 grey
- 04 yellow
- 06 white
- 08 red
- 09 black

+

Bezel

1 6 3 1 0

- 03 grey
- 08 red
- 09 black

Additional colours for 16310 only:

- 00 blue
- 02 green
- 04 yellow
- 06 white

ILLUMINATED – HOW TO ORDER

Switch

1 5 4



+

Cap

1 6 3 0 0



+

Bezel

16311



16312

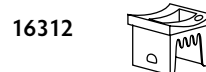

16314



16315

+

LED

1 6 9 2 1

- 02 green
- 04 yellow
- 08 red

+

1 6 9 2 0

- 02 green
- 04 yellow
- 08 red

+

LED 16920 1 required LED 16921 1 required

+

LED 16920 2 required LED 16921 2 required



Ordering example: 15400+1630002+1631002 (non-illuminated) OR 15401+1630003+1631408+1692008+1692108 (illuminated)

Please see colour codes, updates of products and changes of specifications on www.mec.dk



- Square solution
- 15.1mm x 15.1mm
- h=20.5 mm
- Material: ABS
- Temp. Range: -40/+65°C

All dimensions in mm

Tolerances +/-0.2mm

DIMENSIONS

(TH) + 16324

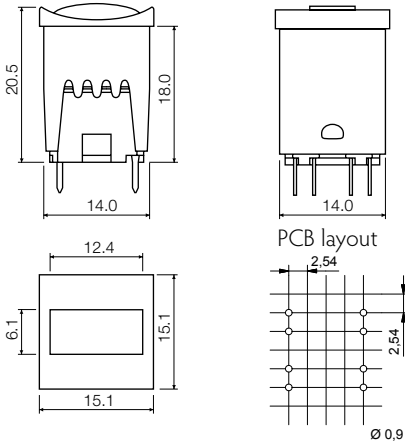

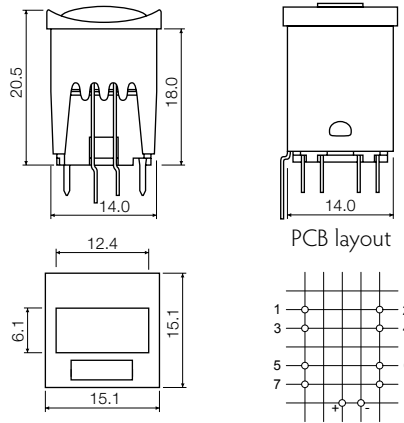

(TH w/LED) + 16325



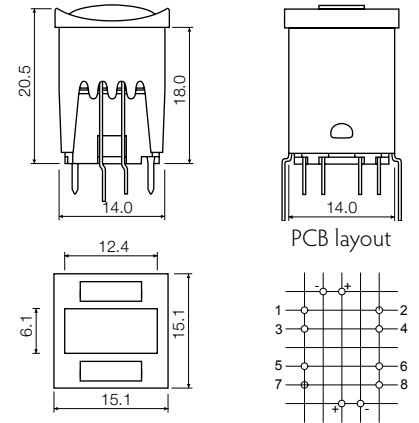





(TH 2 w/LED) + 16326



NON-ILLUMINATED - HOW TO ORDER

Switch		Extender		Cap		Bezel
1 5 4	+	1 6 2 7 0	+	1 6 3 0 0	+	1 6 3 2 4
15401 mom. silver				00 blue		03 grey
15402 mom. gold				02 green		09 black
15420 silent gold				03 grey		
15451 lat. silver				04 yellow		
15452 lat. gold				06 white		
				08 red		
				09 black		

ILLUMINATED - HOW TO ORDER

Switch		Extender		Cap		Bezel		Lens		LED
1 5 4	+	1 6 2 7 0	+	1 6 3 0 0	+		+	1 6 3 2 7	+	1 6 9 2 2
						16325		02 green		02 green
								04 yellow		04 yellow
						16326		08 red		08 red
								Lens 16327		LED 16922
								2 required		2 required
										

Ordering example: 15451+16270+1630004+1632403 (non-illuminated) OR 15401+16270+1630008+1632509+1632708+1692208 (illuminated)
Please see colour codes, updates of products and changes of specifications on www.mec.dk



Standard legends are marked with red.

All standard legends are white on black caps.

The size of the legends listed may not correspond to the actual size. Please ask your local distributor, if you do not find what you need on the list. New legends may have been added after this catalogue was printed.

Custom legends and other colour combinations are available, please contact your local distributor.

Available Legends

Part no.			Part no.			Part no.		
LEGEND	18_	18_	LEGEND	18_	18_	LEGEND	18_	18_
0	000	200	A	010	210	ON/OFF	017	217
1	001	201	B	011	211	STOP	018	218
2	002	202	C	012	212	START	031	231
3	003	203	D	013	213	CLEAR	036	236
4	004	204	E	014	214	LOAD	037	237
5	005	205	F	015	215	RESET	038	238
6	006	206	G	063	263	CR	043	243
7	007	207	H	064	264	MANUAL	044	244
8	008	208	I	065	265	END	047	247
9	009	209	J	066	266	CANCEL	048	248
10	020	220	K	067	267	CTRL	050	250
11	021	221	L	068	268	ESC	051	251
12	022	222	M	069	269	DSP	053	253
13	023	223	N	070	270	ENTER	105	305
14	024	224	P	072	272	SHIFT	106	306
15	025	225	S	075	275	ON	116	316
16	026	226	T	076	276	OFF	117	317
			U	077	277			
			V	078	278			
			W	079	279			
			#	107	207			
			*	019	219			
			☐	016	216			
			→	033	233			
			←	133	233			
			↑	034	234			
			↓	134	234			
			↩	135	235			
			↕	115	215			
			↔	041	241			
			+	054	254			
			-	059	259			
			•	056	256			
			⋮	055	255			



- Max. 250mA/120V/9W AC/6W DC
- 2 pole
- Momentary or latching
- 8 contact functions
- Temperature range:
High temp: -40/+160°C
- Through-hole version (TH)

All dimensions in mm

Tolerances +/-0.2mm

DIMENSIONS THROUGH-HOLE



OPERATING FORCE (TYPICAL EXAMPLE)



PCB MOUNTING HOLE DIMENSIONS

FUNCTIONAL DIAGRAM

CIRCUIT DIAGRAM

Basic switch

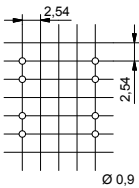

w/Extender 16250

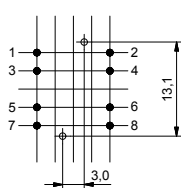

With LED

16923 and 16924

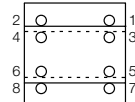

— up
-- down



Without LED



With round LED
16920 and 16921



With rect. LED
16922

WIRING DIAGRAM

Select the contact function you require - and design your PC board accordingly

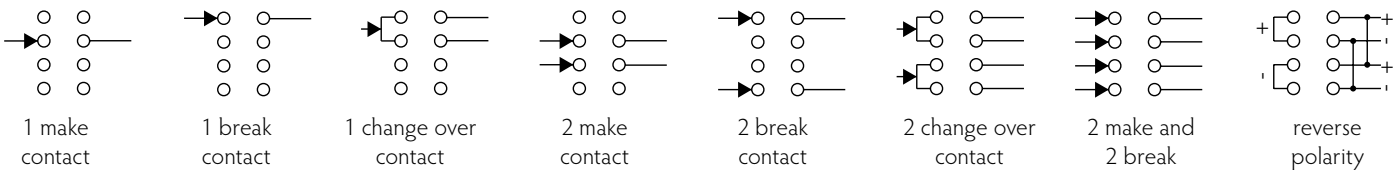

HOW TO ORDER

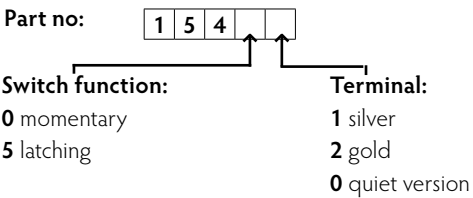

High temp.

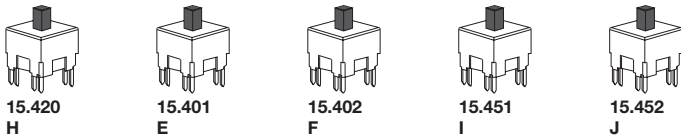

HOW TO ASSEMBLE

unimec™
15XXX+16300 +16310

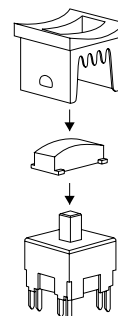

unimec™
15XXX+16270
+16300 +16324

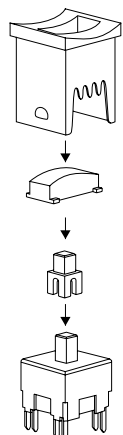

RoHS Compatible

		RA	
		High Temperature Versions	
		Silver	Gold
Electrical Specifications			
Contact resistance		Max. 100 m Ω (initially)	
Insulation resistance		>10 M Ω	
Recommended load		Min. 0.5 mA	Min. 0.5 μA
		Max. 250 mA – 120 V – 9W AC – 6W DC	
Max. Current in non switching state		0.5 A	
Contact bounce		Max. 10 ms	
Dielectric strength between adjacent contacts		1000 V for 2 min.	
Insulation resistance between adjacent contacts		5 X 10 ¹³ Ω	
Capacitance between adjacent contacts		0.5 pF	
Mechanical Specifications			
Standard actuation force (switch)		Typ 2.5N	
Max. Actuation force without cap		100N for 10 sec.	
Key travel (switch)		1.8 mm	
Lifetime	Momentary	>10.000.000 cycles	
	Latching	5.000.000 cycles	
Temperature range			
Working temperature		Min. -40°C Max. +160°C	
Storage temperature		Min. -65°C Max. +160°C	
Soldering IEC 68-2-20		Wave – max 260°C for max. 10 sec., please refer to usage guidelines	
		Soldering iron – max. 350°C for max. 3 sec. Flux tight.	
Environmental Endurance IEC 68-2-3			
Temperature		+40°C	
Humidity		93% RH	
Duration		56 days	
Sealing IEC 529		IP-54	
Cleaning		Standard methods such as water and soap (not immersed)	
Material Specifications – Switches			
Housing and actuator		LCP UL94V0	
Switch spring		Stainless steel	
Key spring		Stainless steel	
Latch pin		Stainless steel	
Fixed contact		SnCu+2μNi+3μAg	SnCu+2μNi+3μAu
Moving contact		Stainless steel +3μAg	Stainless steel +3μAg+1μAu
Terminals		SnCu+2μNi+3μSn100	
Contact lubricant		Special protective lubricant Klüber Barrierta I EL Fluid	
Material Specifications – All Caps & Bezels			
Temperature limit		Max. +65°C	
Tampon Printing		According to ISO Class: 1/ASTM Class:4B	

unimec™ LEDs

Part Nos.	16920/16921			16922			16923					16924			
Colour (G=green, Y=yellow, R=red)	G	Y	R	G	Y	R	B	G	Y	W	R	G	Y	R	
Colour Codes	02	04	08	02	04	08	00	20	40	65	80	23	45	88	
Absolute Maximum Ratings (Ta=25°C)															
Power	mW	100	100	100	135	135	135	105	70	60	120	60	150	130	300
Current forward	mA	30	30	30	30	30	30	30	20	20	25	20	40	40	90
Forward peak current	mA	50	50	50	90	90	90	200	60**	60**	100	60**	500	500	1000
Voltage reverse	V	5	5	5	5	5	5	5	3	3	5	3	12	12	5
Operating temperature	°C	-25 - +100			-55 - +100			-25 - +85					-55 - +100		
Storage temperature	°C	-25 - +100			-55 - +100			-30 - +100					-55 - +100		
Soldering temperature	°C	+245 for max. 3 sec			+300 for max. 3 sec			+260 for max. 5 sec					+300 for max. 3 sec		
Electrical-Optical Characteristics (Ta=25°C)															
Voltage forward	Typ. V	2.0	2.0	2.0	2.1	2.2	2.3	2.1	2.1	2.1	3.8	2.0	2.1*	2.3***	2.4***
	Max. V	3.0	3.0	3.0	3.0	3.0	3.0	2.8	3.0	3.0	4.3	3.0	2.5*	2.5***	3.8***
Current reverse	μA	100	100	100	100	100	100	2	10	10	50	10	10	10	10
Wave length	nm	560	590	660	565	585	635	460	563	585	NA	650	570	587	635
Spread	Ønm	10	10	10	10	10	10	40	40	40	NA	40	25	45	45
Spread angle	Degree	20	20	20	45	45	45	20	45	45	25	45	80	90	55
Luminous Intensity	Min. mcd	1	1	0.8	1.5	2.5	2.5	20	9.0	5.6	630	5.6	71****	71****	100****
	Typ. mcd	2	3	1.6	2.5	3.0	5.0	25	25	16	1000	16	112****	112****	160****
Orientation		The longer pin is the anode, the shorter is the cathode.													

*I_F=20mA, **Pulse width 1ms Duty cycle 1:5, ***I_F=50mA, ****Luminous Flux mlm

For all types of unimec™ switches with bezels - 16310 - 16315 and 16324 - 16326.
More options available as custom.

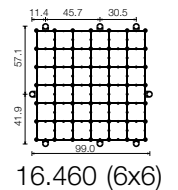
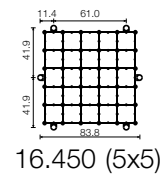
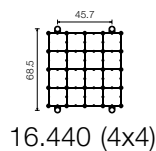
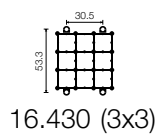
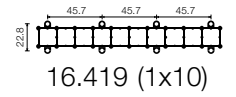
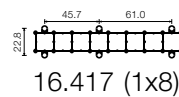
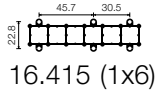
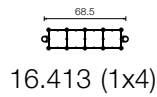
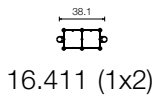
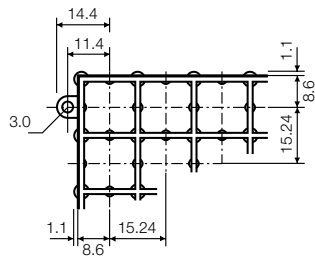

Usage guidelines

How to get the best results with MEC Switches?

These guidelines are offered to users of MEC Switches as an aid to ensure successful and reliable switch operation.

Temperature

Both unimec™ and multimec® switches are produced in low and high temperature versions. Please see the technical specifications for details on operating and storage temperatures and soldering guidelines to make sure you select the best switch for your application. When wave soldering is taking place, MEC strongly recommend that the temperature profile is analysed and compared with the temperature rating of the switch. In case of doubt always select the high temperature versions unimec™ 154XX, and multimec® 5XXH9XX. It is also important to monitor the accumulated heat build up from both the pre-heat zones and the solder zone.

Most standard accessories for both unimec™ and multimec® switches are made from ABS plastic with a maximum operating temperature of 65°C. It is strongly recommended that accessories are mounted after soldering of the switch. If this is not possible care must be taken not to overheat the accessories during the soldering process. The 1SS, 1GAS/1GCS and Varimec™ caps are, however, made of high temperature materials and will meet the same temperature specifications as the high temperature switches.

For accessories made from other plastic materials please see multimec® and unimec™ technical specifications.

LEDs have their own temperature specifications. When fitted in a high temperature switch the LED will determine the max. operating temperature, i.e. 5GTH93524 has an upper temperature limit of 85°C! This also applies with 3F switches.

Mounting and Dismounting

If switches are to be mounted in rows it is essential that the recommendations regarding spacing are followed. PC board thickness should be 1.4±0.2 mm and terminal hole diameter should be 0.9mm.

All unimec™ and multimec® caps and bezels are easily snapped onto the switch modules and can be changed at a later time with the exception of the unimec 16.700 cap. The same applies to the 3E caps. Once these caps are installed they are not designed to be removed. To do so may cause damage to the switch and the PC board if not done very carefully. If the 16.300 or 16.700 cap must be removed from a unimec™ alternate action switch, make sure that the switch actuator is in the released, upper position before attempting to remove the cap. This will prevent possible damage to the internal latching pin.

Care must be taken when inserting the 3FT switch and LED assembly into the PC board. Do not press direct on the LED. This will force the LED down into the actuator and risks to cause the switch contacts to remain in the closed position. To correct the fault, the LED must be raised slightly and centered in the actuator to assure unrestricted movement of the actuator. A mounting tool is available for multimec® switches.

Soldering and Cleaning unimec™

Most assembly and field problems experienced by users of unsealed switches are caused by the contamination of the contacts during soldering and cleaning.

Contact contamination may be recognised by an increase in contact resistance and possible intermittent operation of the switch, especially in low power applications. Care must be taken not to submerge the switch in cleaning agents or spray the switch during cleaning. The switch must be protected at all times to prevent contamination by flux or cleaning liquids.

For unimec™ alternate versions we recommend to leave the actuator in the released upper position during soldering. This makes the switch more resistant to overheating.

Soldering and Cleaning multimec®

multimec® switches are fully sealed to IP67 specifications to prevent solder flux and aqueous based cleaning solutions from entering the switch and contaminating the contacts. The switches can be placed on the PC board with other components and wave soldered. multimec® offers a high level of sealing, however, with aqueous solvent solutions care must be taken to avoid the worst case situation with water jets, complete immersion into a liquid with a temperature below the board or surface tension reducing additives.

Recommended cleaning methods are demineralized water. Any surface tension reducing agents, such as soap, must not be used as they risk causing a potential leakage of the switch.

Soldering - Through Hole Versions

Hand soldering: Max. 350°C for max. 3 sec., this applies for both low temperature and high temperature versions.

Wave soldering: heat built up in the switch during pre-heating and soldering must not exceed the maximum operating temperature of the switch. If, for some reason, a high pre-heating temperature is required, MEC recommend the high temperature switches. In any case peak temperature must not exceed 260°C, and soldering time is max 10 sec.

Soldering - Surface Mount Versions

For all methods - infrared, convection and vapour phase. The upper limit 260°C/30 sec must be observed. The soldering temperature profile must have moderate temperature gradients.

RoHS Compliance

As of 1 July 2006 MEC has completed the conversion to RoHS compliance. For more info please see our homepage www.mec.dk

Temperature Limits:

Low temperature switch	115°C
High temperature switch	160°C
LEDs	85/100°C
Accessories	65/85/160°C

Packaging

unimec™ and multimec® switches are packed in rigid tubes of 50 pieces each.

A box contains 1.000 pcs.

The surface mount versions of multimec® switches with a height up to 12.5mm can also be delivered on tape/reel. Each reel contains 250/500 pcs.

Компания «Life Electronics» занимается поставками электронных компонентов импортного и отечественного производства от производителей и со складов крупных дистрибьюторов Европы, Америки и Азии.

С конца 2013 года компания активно расширяет линейку поставок компонентов по направлению коаксиальный кабель, кварцевые генераторы и конденсаторы (керамические, пленочные, электролитические), за счёт заключения дистрибьюторских договоров

Мы предлагаем:

- Конкуренспособные цены и скидки постоянным клиентам.
- Специальные условия для постоянных клиентов.
- Подбор аналогов.
- Поставку компонентов в любых объемах, удовлетворяющих вашим потребностям.
- Приемлемые сроки поставки, возможна ускоренная поставка.
- Доставку товара в любую точку России и стран СНГ.
- Комплексную поставку.
- Работу по проектам и поставку образцов.
- Формирование склада под заказчика.
- Сертификаты соответствия на поставляемую продукцию (по желанию клиента).
- Тестирование поставляемой продукции.
- Поставку компонентов, требующих военную и космическую приемку.
- Входной контроль качества.
- Наличие сертификата ISO.

В составе нашей компании организован Конструкторский отдел, призванный помогать разработчикам, и инженерам.

Конструкторский отдел помогает осуществить:

- Регистрацию проекта у производителя компонентов.
- Техническую поддержку проекта.
- Защиту от снятия компонента с производства.
- Оценку стоимости проекта по компонентам.
- Изготовление тестовой платы монтаж и пусконаладочные работы.



Тел: +7 (812) 336 43 04 (многоканальный)
Email: org@lifeelectronics.ru