



- Square and rectangular caps
- 6mm x 12.3mm; 14.9mm x 14.9mm; 15.1mm x 15.1mm
- h=16.9mm; 14.6mm; 14.5mm
- Material: ABS
- Temp. Range: -40/+65°C

All dimensions in mm

Tolerances -/+0.2mm

DIMENSIONS

(TH) + 16300



(TH) + 16700



(TH) + 16800



Blanking Cap
to be used with
VARIO SUPPORT

NON-ILLUMINATED- HOW TO ORDER

Switch

1 5 4

- 15401 mom. silver
- 15402 mom. gold.
- 15420 silent gold
- 15451 lat. silver.
- 15452 lat. gold

Cap and color code

+ 1 6 3 0 0



- 00 blue
- 02 green
- 03 grey
- 04 yellow
- 06 white
- 08 red
- 09 black

Switch

1 5 4



+

Cap

1 6 7 0 0



- 00 blue
- 02 green
- 03 grey

- 04 yellow
- 06 white
- 08 red

- 09 black

Ordering example: 15451+1630003 OR 15401+1670008

Please see colour codes, updates of products and changes of specifications on www.mec.dk

- Square solution
- 15.1mm x 15.1mm
- h=16.0 mm
- Material: ABS
- Temp. Range: -40/+65°C



All dimensions in mm

Tolerances +/-0.2mm

DIMENSIONS

(TH) + 16310



(TH w/LED) + 16311



(TH w/LED) + 16312



(TH w/4 LED) + 16315



NON-ILLUMINATED – HOW TO ORDER

Switch

1 5 4

- 15401 mom. silver
- 15402 mom. gold.
- 15420 silent gold
- 15451 lat. silver
- 15452 lat. gold

+

Cap

1 6 3 0 0

- 00 blue
- 02 green
- 03 grey
- 04 yellow
- 06 white
- 08 red
- 09 black

+

Bezel

1 6 3 1 0

- 03 grey
- 08 red
- 09 black

Additional colours for 16310 only:

- 00 blue
- 02 green
- 04 yellow
- 06 white

ILLUMINATED – HOW TO ORDER

Switch

1 5 4



+

Cap

1 6 3 0 0



+

Bezel

16311



16312

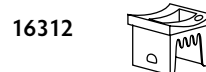

16314



16315

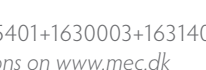

+

LED

1 6 9 2 1

- 02 green
- 04 yellow
- 08 red

+

1 6 9 2 0

- 02 green
- 04 yellow
- 08 red

+

LED 16920 1 required LED 16921 1 required

+

LED 16920 2 required LED 16921 2 required



Ordering example: 15400+1630002+1631002 (non-illuminated) OR 15401+1630003+1631408+1692008+1692108 (illuminated)

Please see colour codes, updates of products and changes of specifications on www.mec.dk



- Square solution
- 15.1mm x 15.1mm
- h=20.5 mm
- Material: ABS
- Temp. Range: -40/+65°C

All dimensions in mm

Tolerances +/-0.2mm

DIMENSIONS

(TH) + 16324



(TH w/LED) + 16325

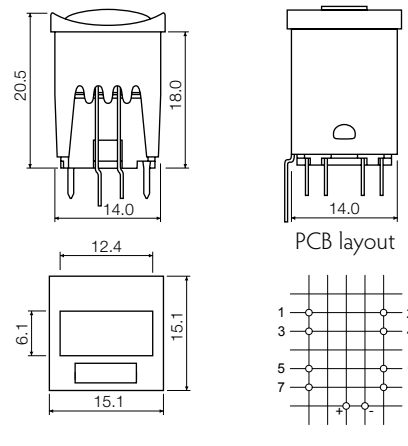

(TH 2 w/LED) + 16326

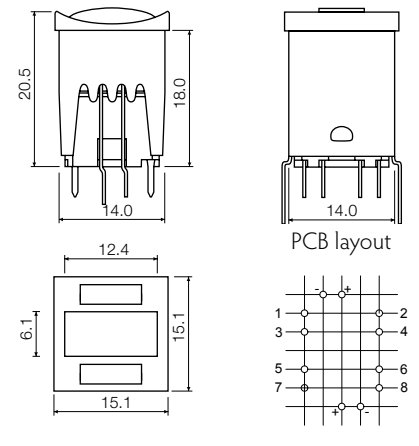

NON-ILLUMINATED - HOW TO ORDER

| | | | | | | |
|-------------------|---|---|---|------------------|---|---|
| Switch | | Extender | | Cap | | Bezel |
| 1 5 4 | + | 1 6 2 7 0 | + | 1 6 3 0 0 | + | 1 6 3 2 4 |
| 15401 mom. silver | |  | | 00 blue |  | 03 grey |
| 15402 mom. gold | | | | 02 green | | 09 black |
| 15420 silent gold | | | | 03 grey | |  |
| 15451 lat. silver | | | | 04 yellow | | |
| 15452 lat. gold | | | | 06 white | | |
| | | | | 08 red | | |
| | | | | 09 black | | |

ILLUMINATED - HOW TO ORDER

| | | | | | | | | | | |
|--|---|---|---|---|---|---|--|---|---|---|
| Switch | | Extender | | Cap | | Bezel | | Lens | | LED |
| 1 5 4 | + | 1 6 2 7 0 | + | 1 6 3 0 0 | + | | | 1 6 3 2 7 | + | 1 6 9 2 2 |
|  | |  | |  | | 16325 | | 02 green | | 02 green |
| | | | | | |  | | 04 yellow | | 04 yellow |
| | | | | | | 16326 | | 08 red | | 08 red |
| | | | | | |  | | Lens 16327 | | LED 16922 |
| | | | | | | | | 2 required | | 2 required |
| | | | | | | | |  | |  |

Ordering example: 15451+16270+1630004+1632403 (non-illuminated) OR 15401+16270+1630008+1632509+1632708+1692208 (illuminated)
Please see colour codes, updates of products and changes of specifications on www.mec.dk



Standard legends are marked with red.

All standard legends are white on black caps.

The size of the legends listed may not correspond to the actual size. Please ask your local distributor, if you do not find what you need on the list. New legends may have been added after this catalogue was printed.

Custom legends and other colour combinations are available, please contact your local distributor.

Available Legends

| Part no. | | | Part no. | | | Part no. | | |
|----------|-----|-----|----------|-----|-----|----------|-----|-----|
| LEGEND | 18_ | 18_ | LEGEND | 18_ | 18_ | LEGEND | 18_ | 18_ |
| 0 | 000 | 200 | A | 010 | 210 | ON/OFF | 017 | 217 |
| 1 | 001 | 201 | B | 011 | 211 | STOP | 018 | 218 |
| 2 | 002 | 202 | C | 012 | 212 | START | 031 | 231 |
| 3 | 003 | 203 | D | 013 | 213 | CLEAR | 036 | 236 |
| 4 | 004 | 204 | E | 014 | 214 | LOAD | 037 | 237 |
| 5 | 005 | 205 | F | 015 | 215 | RESET | 038 | 238 |
| 6 | 006 | 206 | G | 063 | 263 | CR | 043 | 243 |
| 7 | 007 | 207 | H | 064 | 264 | MANUAL | 044 | 244 |
| 8 | 008 | 208 | I | 065 | 265 | END | 047 | 247 |
| 9 | 009 | 209 | J | 066 | 266 | CANCEL | 048 | 248 |
| 10 | 020 | 220 | K | 067 | 267 | CTRL | 050 | 250 |
| 11 | 021 | 221 | L | 068 | 268 | ESC | 051 | 251 |
| 12 | 022 | 222 | M | 069 | 269 | DSP | 053 | 253 |
| 13 | 023 | 223 | N | 070 | 270 | ENTER | 105 | 305 |
| 14 | 024 | 224 | P | 072 | 272 | SHIFT | 106 | 306 |
| 15 | 025 | 225 | S | 075 | 275 | ON | 116 | 316 |
| 16 | 026 | 226 | T | 076 | 276 | OFF | 117 | 317 |
| | | | U | 077 | 277 | | | |
| | | | V | 078 | 278 | | | |
| | | | W | 079 | 279 | | | |
| | | | # | 107 | 207 | | | |
| | | | * | 019 | 219 | | | |
| | | | ☐ | 016 | 216 | | | |
| | | | → | 033 | 233 | | | |
| | | | ← | 133 | 233 | | | |
| | | | ↑ | 034 | 234 | | | |
| | | | ↓ | 134 | 234 | | | |
| | | | ↵ | 135 | 235 | | | |
| | | | ↕ | 115 | 215 | | | |
| | | | ↔ | 041 | 241 | | | |
| | | | + | 054 | 254 | | | |
| | | | - | 059 | 259 | | | |
| | | | • | 056 | 256 | | | |
| | | | ⋮ | 055 | 255 | | | |



- Max. 250mA/120V/9W AC/6W DC
- 2 pole
- Momentary or latching
- 8 contact functions
- Temperature range:
High temp: -40/+160°C
- Through-hole version (TH)

All dimensions in mm

Tolerances +/-0.2mm

DIMENSIONS THROUGH-HOLE



OPERATING FORCE (TYPICAL EXAMPLE)



PCB MOUNTING HOLE DIMENSIONS

FUNCTIONAL DIAGRAM

CIRCUIT DIAGRAM

Basic switch



w/Extender 16250

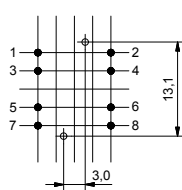

With LED

16923 and 16924



— up
-- down

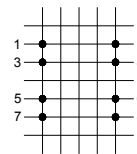

Without LED

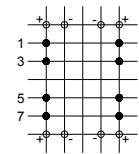

With round LED
16920 and 16921

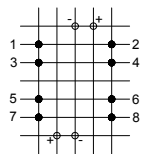

With rect. LED
16922

WIRING DIAGRAM

Select the contact function you require - and design your PC board accordingly

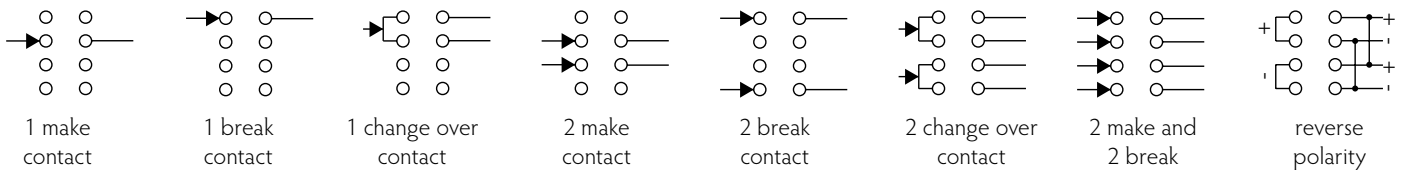

HOW TO ORDER

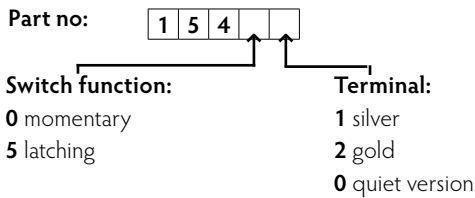

High temp.

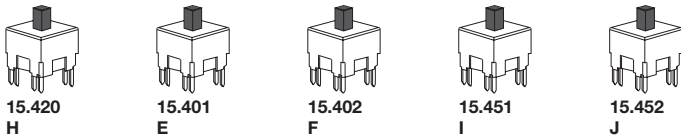

HOW TO ASSEMBLE

unimec™
15XXX+16300 +16310

unimec™
15XXX+16270
+16300 +16324

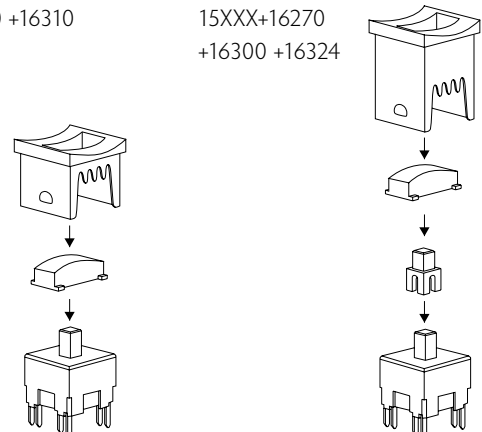

RoHS Compatible

| | | RA | |
|--|-----------|---|----------------------------|
| | | High Temperature Versions | |
| | | Silver | Gold |
| Electrical Specifications | | | |
| Contact resistance | | Max. 100 m Ω (initially) | |
| Insulation resistance | | >10 M Ω | |
| Recommended load | | Min. 0.5 mA | Min. 0.5 μA |
| | | Max. 250 mA – 120 V – 9W AC – 6W DC | |
| Max. Current in non switching state | | 0.5 A | |
| Contact bounce | | Max. 10 ms | |
| Dielectric strength between adjacent contacts | | 1000 V for 2 min. | |
| Insulation resistance between adjacent contacts | | 5 X 10 ¹³ Ω | |
| Capacitance between adjacent contacts | | 0.5 pF | |
| Mechanical Specifications | | | |
| Standard actuation force (switch) | | Typ 2.5N | |
| Max. Actuation force without cap | | 100N for 10 sec. | |
| Key travel (switch) | | 1.8 mm | |
| Lifetime | Momentary | >10.000.000 cycles | |
| | Latching | 5.000.000 cycles | |
| Temperature range | | | |
| Working temperature | | Min. -40°C Max. +160°C | |
| Storage temperature | | Min. -65°C Max. +160°C | |
| Soldering IEC 68-2-20 | | | |
| | | Wave – max 260°C for max. 10 sec., please refer to usage guidelines | |
| | | Soldering iron – max. 350°C for max. 3 sec. Flux tight. | |
| Environmental Endurance IEC 68-2-3 | | | |
| Temperature | | +40°C | |
| Humidity | | 93% RH | |
| Duration | | 56 days | |
| Sealing IEC 529 | | IP-54 | |
| Cleaning | | Standard methods such as water and soap (not immersed) | |
| Material Specifications – Switches | | | |
| Housing and actuator | | LCP UL94V0 | |
| Switch spring | | Stainless steel | |
| Key spring | | Stainless steel | |
| Latch pin | | Stainless steel | |
| Fixed contact | | SnCu+2μNi+3μAg | SnCu+2μNi+3μAu |
| Moving contact | | Stainless steel +3μAg | Stainless steel +3μAg+1μAu |
| Terminals | | | |
| Contact lubricant | | Special protective lubricant Klüber Barrierta I EL Fluid | |
| Material Specifications – All Caps & Bezels | | | |
| Temperature limit | | Max. +65°C | |
| Tampon Printing | | | |
| | | According to ISO Class: 1/ASTM Class:4B | |

unimec™ LEDs

| Part Nos. | 16920/16921 | | | 16922 | | | 16923 | | | | | 16924 | | | |
|--|-------------|--|-----|-------|---------------------|-----|-------|---------------------|------|------|------|-------|---------------------|---------|---------|
| Colour (G=green, Y=yellow, R=red) | G | Y | R | G | Y | R | B | G | Y | W | R | G | Y | R | |
| Colour Codes | 02 | 04 | 08 | 02 | 04 | 08 | 00 | 20 | 40 | 65 | 80 | 23 | 45 | 88 | |
| Absolute Maximum Ratings (Ta=25°C) | | | | | | | | | | | | | | | |
| Power | mW | 100 | 100 | 100 | 135 | 135 | 135 | 105 | 70 | 60 | 120 | 60 | 150 | 130 | 300 |
| Current forward | mA | 30 | 30 | 30 | 30 | 30 | 30 | 30 | 20 | 20 | 25 | 20 | 40 | 40 | 90 |
| Forward peak current | mA | 50 | 50 | 50 | 90 | 90 | 90 | 200 | 60** | 60** | 100 | 60** | 500 | 500 | 1000 |
| Voltage reverse | V | 5 | 5 | 5 | 5 | 5 | 5 | 5 | 3 | 3 | 5 | 3 | 12 | 12 | 5 |
| Operating temperature | °C | -25 - +100 | | | -55 - +100 | | | -25 - +85 | | | | | -55 - +100 | | |
| Storage temperature | °C | -25 - +100 | | | -55 - +100 | | | -30 - +100 | | | | | -55 - +100 | | |
| Soldering temperature | °C | +245 for max. 3 sec | | | +300 for max. 3 sec | | | +260 for max. 5 sec | | | | | +300 for max. 3 sec | | |
| Electrical-Optical Characteristics (Ta=25°C) | | | | | | | | | | | | | | | |
| Voltage forward | Typ. V | 2.0 | 2.0 | 2.0 | 2.1 | 2.2 | 2.3 | 2.1 | 2.1 | 2.1 | 3.8 | 2.0 | 2.1* | 2.3*** | 2.4*** |
| | Max. V | 3.0 | 3.0 | 3.0 | 3.0 | 3.0 | 3.0 | 2.8 | 3.0 | 3.0 | 4.3 | 3.0 | 2.5* | 2.5*** | 3.8*** |
| Current reverse | μA | 100 | 100 | 100 | 100 | 100 | 100 | 2 | 10 | 10 | 50 | 10 | 10 | 10 | 10 |
| Wave length | nm | 560 | 590 | 660 | 565 | 585 | 635 | 460 | 563 | 585 | NA | 650 | 570 | 587 | 635 |
| Spread | Ønm | 10 | 10 | 10 | 10 | 10 | 10 | 40 | 40 | 40 | NA | 40 | 25 | 45 | 45 |
| Spread angle | Degree | 20 | 20 | 20 | 45 | 45 | 45 | 20 | 45 | 45 | 25 | 45 | 80 | 90 | 55 |
| Luminous Intensity | Min. mcd | 1 | 1 | 0.8 | 1.5 | 2.5 | 2.5 | 20 | 9.0 | 5.6 | 630 | 5.6 | 71**** | 71**** | 100**** |
| | Typ. mcd | 2 | 3 | 1.6 | 2.5 | 3.0 | 5.0 | 25 | 25 | 16 | 1000 | 16 | 112**** | 112**** | 160**** |
| Orientation | | The longer pin is the anode, the shorter is the cathode. | | | | | | | | | | | | | |

*I_F=20mA, **Pulse width 1ms Duty cycle 1:5, ***I_F=50mA, ****Luminous Flux mlm

For all types of unimec™ switches with bezels - 16310 - 16315 and 16324 - 16326.
More options available as custom.

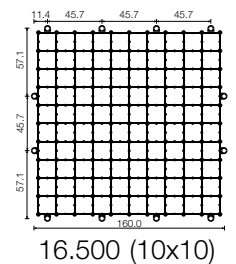
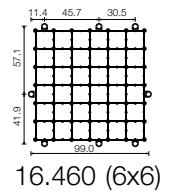
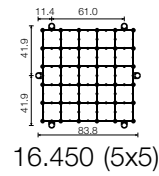
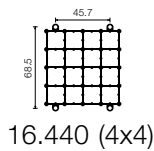
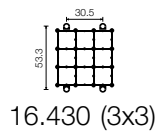
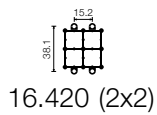
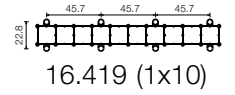
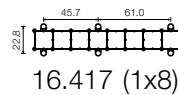
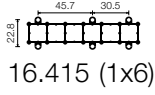
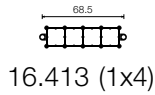
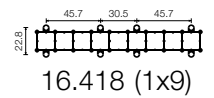
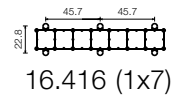
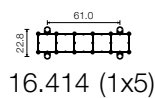
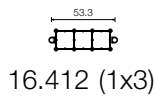
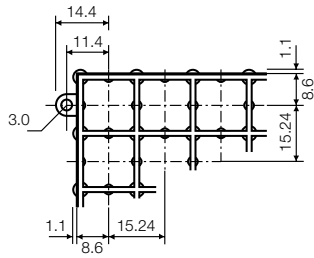

Usage guidelines

How to get the best results with MEC Switches?

These guidelines are offered to users of MEC Switches as an aid to ensure successful and reliable switch operation.

Temperature

Both unimec™ and multimec® switches are produced in low and high temperature versions. Please see the technical specifications for details on operating and storage temperatures and soldering guidelines to make sure you select the best switch for your application. When wave soldering is taking place, MEC strongly recommend that the temperature profile is analysed and compared with the temperature rating of the switch. In case of doubt always select the high temperature versions unimec™ 154XX, and multimec® 5XXH9XX. It is also important to monitor the accumulated heat build up from both the pre-heat zones and the solder zone.

Most standard accessories for both unimec™ and multimec® switches are made from ABS plastic with a maximum operating temperature of 65°C. It is strongly recommended that accessories are mounted after soldering of the switch. If this is not possible care must be taken not to overheat the accessories during the soldering process. The 1SS, 1GAS/1GCS and Varimec™ caps are, however, made of high temperature materials and will meet the same temperature specifications as the high temperature switches.

For accessories made from other plastic materials please see multimec® and unimec™ technical specifications.

LEDs have their own temperature specifications. When fitted in a high temperature switch the LED will determine the max. operating temperature, i.e. 5GTH93524 has an upper temperature limit of 85°C! This also applies with 3F switches.

Mounting and Dismounting

If switches are to be mounted in rows it is essential that the recommendations regarding spacing are followed. PC board thickness should be 1.4±0.2 mm and terminal hole diameter should be 0.9mm.

All unimec™ and multimec® caps and bezels are easily snapped onto the switch modules and can be changed at a later time with the exception of the unimec 16.700 cap. The same applies to the 3E caps. Once these caps are installed they are not designed to be removed. To do so may cause damage to the switch and the PC board if not done very carefully. If the 16.300 or 16.700 cap must be removed from a unimec™ alternate action switch, make sure that the switch actuator is in the released, upper position before attempting to remove the cap. This will prevent possible damage to the internal latching pin.

Care must be taken when inserting the 3FT switch and LED assembly into the PC board. Do not press direct on the LED. This will force the LED down into the actuator and risks to cause the switch contacts to remain in the closed position. To correct the fault, the LED must be raised slightly and centered in the actuator to assure unrestricted movement of the actuator. A mounting tool is available for multimec® switches.

Soldering and Cleaning unimec™

Most assembly and field problems experienced by users of unsealed switches are caused by the contamination of the contacts during soldering and cleaning.

Contact contamination may be recognised by an increase in contact resistance and possible intermittent operation of the switch, especially in low power applications. Care must be taken not to submerge the switch in cleaning agents or spray the switch during cleaning. The switch must be protected at all times to prevent contamination by flux or cleaning liquids.

For unimec™ alternate versions we recommend to leave the actuator in the released upper position during soldering. This makes the switch more resistant to overheating.

Soldering and Cleaning multimec®

multimec® switches are fully sealed to IP67 specifications to prevent solder flux and aqueous based cleaning solutions from entering the switch and contaminating the contacts. The switches can be placed on the PC board with other components and wave soldered. multimec® offers a high level of sealing, however, with aqueous solvent solutions care must be taken to avoid the worst case situation with water jets, complete immersion into a liquid with a temperature below the board or surface tension reducing additives.

Recommended cleaning methods are demineralized water. Any surface tension reducing agents, such as soap, must not be used as they risk causing a potential leakage of the switch.

Soldering - Through Hole Versions

Hand soldering: Max. 350°C for max. 3 sec., this applies for both low temperature and high temperature versions.

Wave soldering: heat built up in the switch during pre-heating and soldering must not exceed the maximum operating temperature of the switch. If, for some reason, a high pre-heating temperature is required, MEC recommend the high temperature switches. In any case peak temperature must not exceed 260°C, and soldering time is max 10 sec.

Soldering - Surface Mount Versions

For all methods - infrared, convection and vapour phase. The upper limit 260°C/30 sec must be observed. The soldering temperature profile must have moderate temperature gradients.

RoHS Compliance

As of 1 July 2006 MEC has completed the conversion to RoHS compliance. For more info please see our homepage www.mec.dk

Temperature Limits:

| | |
|-------------------------|-------------|
| Low temperature switch | 115°C |
| High temperature switch | 160°C |
| LEDs | 85/100°C |
| Accessories | 65/85/160°C |

Packaging

unimec™ and multimec® switches are packed in rigid tubes of 50 pieces each.

A box contains 1.000 pcs.

The surface mount versions of multimec® switches with a height up to 12.5mm can also be delivered on tape/reel. Each reel contains 250/500 pcs.

Компания «Life Electronics» занимается поставками электронных компонентов импортного и отечественного производства от производителей и со складов крупных дистрибьюторов Европы, Америки и Азии.

С конца 2013 года компания активно расширяет линейку поставок компонентов по направлению коаксиальный кабель, кварцевые генераторы и конденсаторы (керамические, пленочные, электролитические), за счёт заключения дистрибьюторских договоров

Мы предлагаем:

- Конкурентоспособные цены и скидки постоянным клиентам.
- Специальные условия для постоянных клиентов.
- Подбор аналогов.
- Поставку компонентов в любых объемах, удовлетворяющих вашим потребностям.
- Приемлемые сроки поставки, возможна ускоренная поставка.
- Доставку товара в любую точку России и стран СНГ.
- Комплексную поставку.
- Работу по проектам и поставку образцов.
- Формирование склада под заказчика.
- Сертификаты соответствия на поставляемую продукцию (по желанию клиента).
- Тестирование поставляемой продукции.
- Поставку компонентов, требующих военную и космическую приемку.
- Входной контроль качества.
- Наличие сертификата ISO.

В составе нашей компании организован Конструкторский отдел, призванный помогать разработчикам, и инженерам.

Конструкторский отдел помогает осуществить:

- Регистрацию проекта у производителя компонентов.
- Техническую поддержку проекта.
- Защиту от снятия компонента с производства.
- Оценку стоимости проекта по компонентам.
- Изготовление тестовой платы монтаж и пусконаладочные работы.



Тел: +7 (812) 336 43 04 (многоканальный)

Email: org@lifeelectronics.ru