

## Evaluation Board for CS43L22

### Features

- ◆ Analog Passthrough Input
  - Four Stereo Line Input Jacks
  - Channel Mixer
- ◆ Analog Output
  - Stereo Headphone Jack w/ HP Detect Capability
  - Speaker Output via Differential Stereo PWM Terminals and Audio Jacks
- ◆ 8- to 96-kHz S/PDIF Interface
  - Optical and RCA S/PDIF Input Jacks
  - CS8416 Digital Audio Receiver
- ◆ I/O Stake Headers
  - External Control Port Accessibility
  - External DSP Serial Audio I/O Accessibility
- ◆ Multiple Power Supply options via Battery or External Power Supplies.
- ◆ 1.8 V to 3.3 V Logic Interface
- ◆ FlexGUI S/W Control - Windows® Compatible
  - Pre-Defined & User-Configurable Scripts

### Description

Using the CDB43L22 evaluation board is an ideal way to evaluate the CS43L22. Use of the board requires an analog/digital signal source, an analyzer and power supplies. A Windows PC-compatible computer is also required in order to configure the CDB43L22.

System timing can be provided by the CS8416, by the CS43L22 with supplied master clock, or via an I/O stake header with a DSP connected. 1/8th inch audio jacks are provided for the analog passthrough inputs and HP/Line outputs. Two pairs of banana jacks and an additional pair of 1/8th inch audio jacks are provided to monitor the stereo differential speaker PWM output from the CS43L22. Digital input connections are via RCA phono or optical connectors to the CS8416 (S/PDIF Rx).

The Windows-based software GUI provided makes configuring the CDB43L22 easy. The software communicates through the PC's USB port to configure the board and FPGA registers so that all features of the CS43L22 can be evaluated. The evaluation board may also be configured to accept external timing and data signals for operation in a user application during system development.

### ORDERING INFORMATION

CDB43L22

Evaluation Board

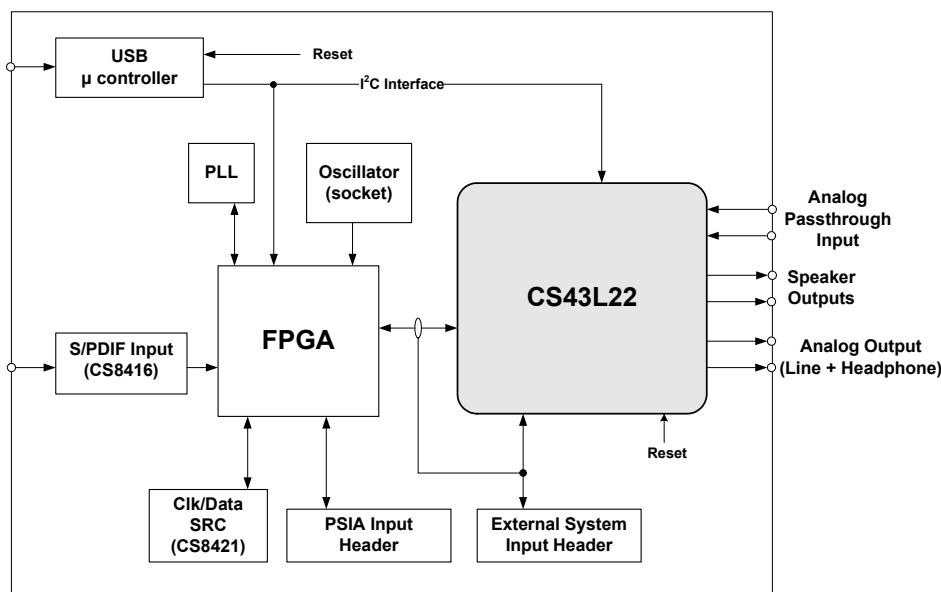

---

**TABLE OF CONTENTS**

<b>1. SYSTEM OVERVIEW .....</b>	<b>4</b>
1.1 Power .....	4
1.2 Grounding and Power Supply Decoupling .....	4
1.3 FPGA .....	4
1.4 CS43L22 .....	4
1.5 CS8416 Digital Audio Receiver .....	5
1.6 Oscillator .....	5
1.7 I/O Stake Headers .....	5
1.8 Analog Inputs .....	5
1.9 Analog Outputs .....	5
1.10 Control Port Connectors .....	6
1.11 USB Connector .....	6
<b>2. QUICK START GUIDE .....</b>	<b>7</b>
<b>3. CONFIGURATION OPTIONS .....</b>	<b>8</b>
3.1 SPDIF In to Headphone or Line Out .....	8
3.2 SPDIF In to Stereo Speaker Out .....	9
3.3 SPDIF In to Mono Speaker Out .....	10
<b>4. SOFTWARE MODE CONTROL .....</b>	<b>11</b>
4.1 Board Configuration Tab .....	12
4.2 Passthrough, Power and Serial Audio Interface Configuration Tab .....	13
4.3 DSP Engine Tab .....	14
4.4 Analog and PWM Output Volume Tab .....	15
4.5 Register Maps Tab .....	16
<b>5. SYSTEM CONNECTIONS AND JUMPERS .....</b>	<b>17</b>
<b>6. JUMPER SETTINGS .....</b>	<b>18</b>
<b>7. CDB43L22 BLOCK DIAGRAM .....</b>	<b>19</b>
<b>8. CDB43L22 SCHEMATICS .....</b>	<b>20</b>
<b>9. CDB43L22 LAYOUT .....</b>	<b>24</b>
<b>10. PERFORMANCE PLOTS .....</b>	<b>29</b>
<b>11. REVISION HISTORY .....</b>	<b>31</b>

**LIST OF FIGURES**

Figure 1.SPDIF In to Headphone or Line Out .....	8
Figure 2.SPDIF In to Stereo Speaker Out .....	9
Figure 3.SPDIF In to Mono Speaker Out .....	10
Figure 4.Board Configuration Tab .....	12
Figure 5.Passthrough, Power and Serial Audio Interface Configuration Tab .....	13
Figure 6.DSP Engine Tab .....	14
Figure 7.Analog and PWM Output Volume Tab .....	15
Figure 8.Register Maps Tab - CS43L22 .....	16
Figure 9.Block Diagram .....	19
Figure 10.CS43L22 & Analog I/O (Schematic Sheet 1) .....	20
Figure 11.S/PDIF & Digital Interface (Schematic Sheet 2) .....	21
Figure 12.Micro & FPGA Control (Schematic Sheet 3) .....	22
Figure 13.Power (Schematic Sheet 4) .....	23
Figure 14.Silk Screen .....	24
Figure 15.Top-Side Layer .....	25
Figure 16.GND (Layer 2) .....	26
Figure 17.Power (Layer 3) .....	27
Figure 18.Bottom-Side Layer .....	28
Figure 19.FFT - S/PDIF Input to HP Output @ -1 dBFS .....	29
Figure 20.FFT - S/PDIF Input to HP Output @ -60 dBFS .....	29

---

Figure 21. THD+N vs. HP Output Power .....	29
Figure 22. Freq. Resp. - S/PDIF Input to HP Output .....	29
Figure 23. THD+N - S/PDIF Input to HP Output .....	29
Figure 24. Dynamic Range- S/PDIF Input to HP Output .....	29
Figure 25. FFT - S/PDIF In to Speaker Out @ 0 dBFS .....	30
Figure 26. FFT - S/PDIF In to Speaker Out @ -60 dBFS .....	30
Figure 27. Frequency Response - S/PDIF In to Speaker Out .....	30
Figure 28. THD+N - S/PDIF In to Speaker Out .....	30
Figure 29. THD+N vs. Output Power (Stereo) .....	30
Figure 30. THD+N vs. Output Power (Mono) .....	30

## LIST OF TABLES

Table 1. SPDIF In to Headphone or Line Out Performance Plots .....	8
Table 2. SPDIF In to Stereo Speaker Out Performance Plots .....	9
Table 3. SPDIF In to Mono Speaker Out Performance Plots .....	10
Table 4. System Connections .....	17
Table 5. Jumper Settings .....	18

## 1. SYSTEM OVERVIEW

The CDB43L22 platform provides analog and digital interfaces to the CS43L22 and allows for external DSP and I<sup>2</sup>C® interconnects. On-board power regulators are provided so that an external power supply upto +5 V can be used to provide power for the digital and analog cores of the CS43L22. On-board peripherals are powered from the USB connection which also serves as an interface to a PC. The CDB43L22 is configured using Cirrus Logic's Windows-compatible FlexGUI software to read/write to device registers.

This section describes the various components on the CDB43L22 and how they are used. [Section 2 on page 7](#) is a simplified quick connect guide provided for user convenience and can be used to set up the board quickly with the CS43L22 in its startup default configuration. [Section 3 on page 8](#) describes the various configuration options in which the board can be used. [Section 4 "Software Mode Control" on page 11](#) provides further configuration details and describes software functionality. The CDB43L22 schematic set is shown in [Figures 7 through 18](#). [Section 5 on page 17](#) provides a description of all stake headers and connectors, including the default factory settings for all jumpers.

### 1.1 Power

Power is supplied to the evaluation board via the USB connection or by applying +5.0 V to TP2. Jumper J34 allows the user to select the power source. Power (VP) and ground (GND) for the CS43L22 is supplied via binding posts J35 and J4 (respectively) or by standard AAA batteries in locations BT1, BT2 and BT3. The voltage provided to the binding posts can be in the range of +2.7 V to +5.25 V. On-board regulators and jumpers allow the user to connect the CS43L22's supplies to +1.8 V, 2.5 V or +3.3 V for VL and +1.8 V or 2.5 V for VD, VA and VA\_HP. All voltage inputs are referenced to ground using the black binding post J4.

Stake headers J47, J52, J53 and J74 provide a convenient way to measure supply currents to the CS43L22 for VA\_HP, VL, VD and VA supplies respectively. The current can be easily calculated by measuring the voltage drop across the parallel resistors with its associated jumper removed.

**NOTE:** Stake headers J47, J48, J52, J53 and J74 must be shunted with the supplied jumpers during normal operation.

**WARNING:** Please refer to the CS43L22 data sheet for allowable voltage levels.

### 1.2 Grounding and Power Supply Decoupling

The CS43L22 requires careful attention to power supply and grounding arrangements to optimize performance. The CDB43L22 demonstrates these optimal arrangements. [Figure 9 on page 19](#) provides an overview of the connections to the CS43L22. [Figure 14 on page 24](#) shows the component placement, [Figure 15 on page 25](#) shows the top layout, and [Figure 18 on page 28](#) shows the bottom layout. Power supply decoupling capacitors are located as close as possible to the CS43L22. Extensive use of ground plane fill helps reduce radiated noise.

### 1.3 FPGA

The FPGA controls digital signal routing between the CS43L22, CS8416, SRC, PLL and the I/O stake header. It also provides routing control of the system master clock from an on-board oscillator and the CS8416. The Cirrus FlexGUI software provides full control of the FPGA's routing and configuration options. [Section 4 "Software Mode Control" on page 11](#) provides configuration details.

### 1.4 CS43L22

A complete description of the CS43L22 can be found in the CS43L22 product data sheet.

The CS43L22 is configured using the Cirrus FlexGUI. The device configuration registers are accessible via the “Register Maps” tab of the Cirrus FlexGUI software. This tab provides low-level control of each bit. For easier configuration, additional tabs provide high-level control. [Section 4 “Software Mode Control” on page 11](#) provides configuration details.

## 1.5 CS8416 Digital Audio Receiver

A complete description of the CS8416 receiver and a discussion of the digital audio interface can be found in the CS8416 data sheet.

The CS8416 converts the input S/PDIF data stream from the optical or RCA connector into PCM data that is input to the CS43L22.

Selections are made by using the “Board Configuration” tab of the Cirrus FlexGUI software. [Section 4 “Software Mode Control” on page 11](#) provides configuration details.

## 1.6 Oscillator

The socketed on-board oscillator can be selected as the system master clock source by using the selections on the “Board Configuration” tab of the Cirrus FlexGUI. [Section 4 “Software Mode Control” on page 11](#) provides configuration details.

The oscillator is mounted in pin sockets, allowing easy removal or replacement. The device footprint on the board will accommodate full- or half-can-sized oscillators.

## 1.7 I/O Stake Headers

The evaluation board has been designed to allow interfacing with external systems via a serial port header (reference designation J8) and a control port header (reference designation J109). The serial port header provides access to the serial audio signals required to interface with a DSP ([Figure 10 on page 20](#)).

The control port header provides bidirectional access to the I<sup>2</sup>C control port signals by simply removing all the shunt jumpers from the “USB” position. The user may then connect a ribbon cable connector to the “Ext Sys Connect” pins for external control of board functions. A single row of “GND” pins are provided to maintain signal ground integrity. Two unpopulated pull-up resistors are also available should the user choose to use the CDB43L22 logic supply (VL) externally.

## 1.8 Analog Inputs

Four stereo jack connectors can be used to supply AC coupled line-level analog inputs to the CS43L22 for testing the device in passthrough mode.

[Figure 10 on page 20](#) illustrates how the analog passthrough inputs are connected and routed. [Table 5 on page 18](#) details the jumper selections. The CS43L22 data sheet specifies the allowed full scale input voltage level.

## 1.9 Analog Outputs

The CDB43L22 has a stereo headphone/line output jack (J40) and a dedicated stereo headphone (HP) output jack (J21) to monitor the CS43L22’s ground centered analog output. The dedicated HP jack (J21) has circuitry that drives the SPKR/HP pin low when a stereo jack is inserted thereby allowing users to test the CS43L22’s HP detect capability. Stake headers (J3 and J9) are provided to allow the user to select either a 16  $\Omega$  or a 32  $\Omega$  load for the headphone amplifier output. Stake headers (J1 and J2) are also provided to allow one to filter HP/Line outputs from the board. HP jack J21 can be used to connect a real headphone to provide an actual headphone load while performance measurements are taken on HP jack J40. When con-

necting headphones to either output jack, the on-board resistive load should be disconnected by removing the jumpers on each stake header(J3 and J9).

The CDB43L22 also has A/B speaker output banana jacks (2 per A or B channel) and 1/8" jack outputs (1 per A or B channel). Stake headers J15 and J19 allow one to short the differential outputs of Channel A and B together, in order to monitor MONO PWM output from the CS43L22. The red banana jacks designate the positive speaker terminal connection and the black jacks designate the negative terminal connection.

## 1.10 Control Port Connectors

The graphical user interface for the CDB43L22 (Cirrus Logic Flex GUI) allows the user to configure the CS43L22 registers and other component registers via the on-board I<sup>2</sup>C control bus. The GUI interfaces with the CDB via the USB connection to a PC. [Section 4 "Software Mode Control" on page 11](#) provides a description of the Graphical User Interface (GUI).

## 1.11 USB Connector

Connecting a USB port cable from a PC to the USB connector on the board and launching the Cirrus FlexGUI software enables one to use the CDB43L22. Note: The USB port connection also provides DC power to the board (except for VP). The minimum current required is approximately 300 mA. It may, therefore, be necessary to connect the CDB43L22 directly to the USB port on the PC as opposed to a hub or keyboard port where current may be limited.

## 2. QUICK START GUIDE

The following figure is a simplified quick start up guide made for user convenience. The following start up guide configures the board with a 1.8 V power supply to VL, VA, VA\_HP and VD. The user may choose from steps 9 through 13 depending on the desired measurement. Refer to [Section 3 on page 8](#) for details on how the various components on the board interface with each other in different board configuration modes. Refer to [Section 4 on page 11](#) for descriptions on control settings in the Cirrus FlexGUI software.

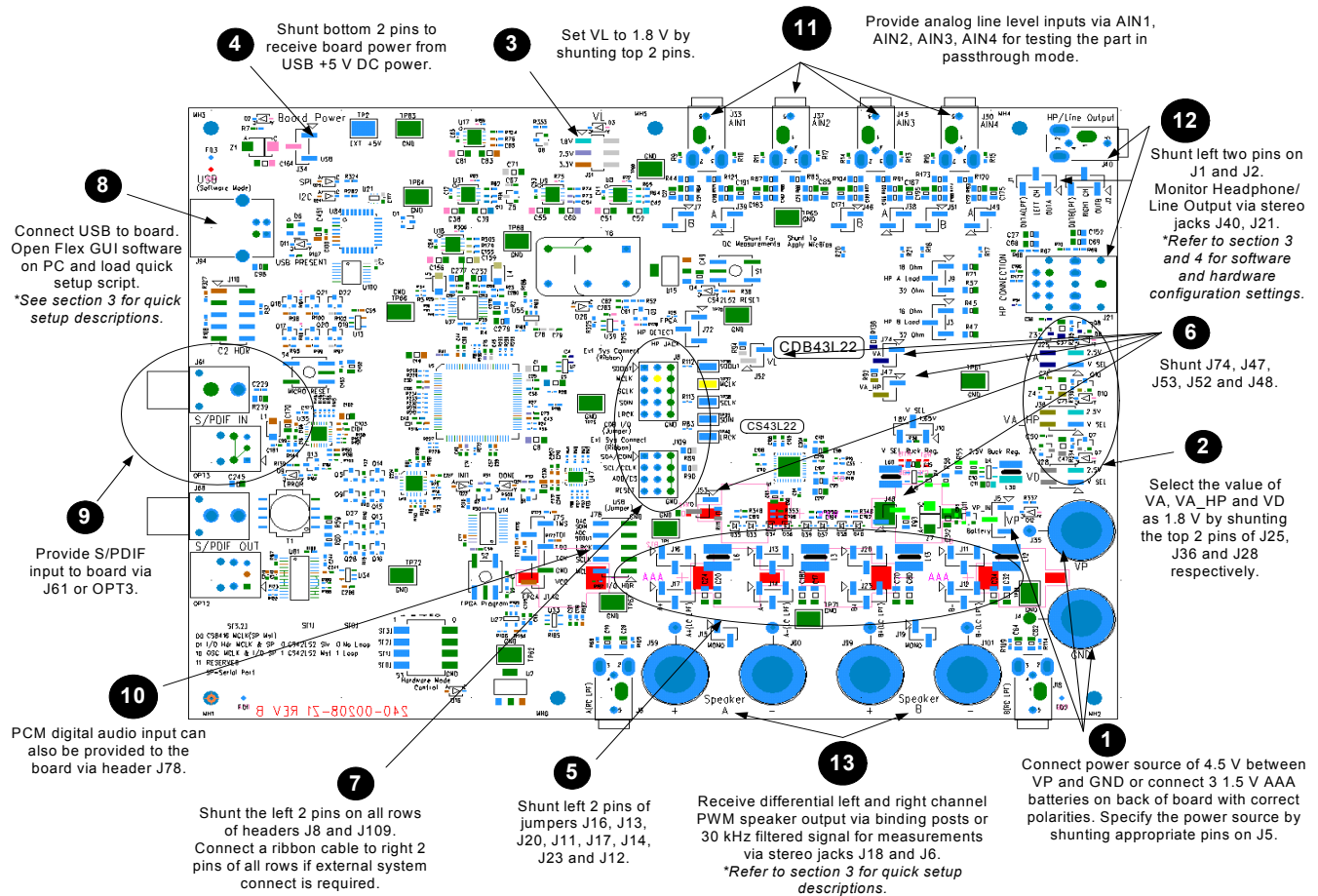



### 3. CONFIGURATION OPTIONS

In order to configure the CDB43L22 for making performance measurements, one needs to use Cirrus Logic’s Windows compatible FlexGUI software to program the various components on the board. This section serves to give a deeper understanding of the on-board circuitry and the digital clock and data signal routing involved in the different configuration modes of the CDB43L22. The section also has the expected performance characteristics which are observed when using the board in the respective configuration mode.

#### 3.1 SPDIF In to Headphone or Line Out

The CS43L22’s stereo headphone/line output performance can be tested by loading the “**SPDIF In to Headphone or Line Out**” quick setup file provided with the software package. The script configures the digital clock and data signal routing on the board as shown in [Figure 1](#).

Stereo audio outputs can be monitored on the 1/8” jacks J21 or J40. HP jack J21 can be used to connect a real headphone to provide an actual headphone load while performance measurements are taken on HP jack J40. Digital S/PDIF input can be provided on the optical (OPT2) or RCA (J68) jacks. Jumpers J8 and J9 can be used to select output loads and jumpers J1 and J2 can be used to select filtered or unfiltered outputs. Refer to [Section 4 on page 11](#) for details on software configuration.

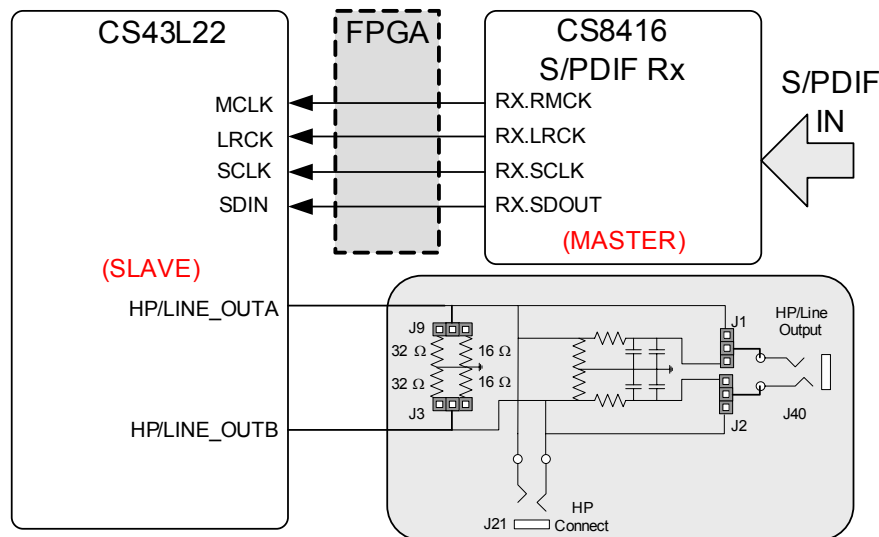

**Figure 1. SPDIF In to Headphone or Line Out**

[Table 1](#) shows the expected performance characteristics one should expect when using the CDB43L22 for SPDIF In to Headphone or Line Out measurements.

Plot	Location
FFT - S/PDIF Input to HP Output @ -1dBFS	<a href="#">Figure 19 on page 29</a>
FFT - S/PDIF Input to HP Output @ -60dBFS	<a href="#">Figure 20 on page 29</a>
THD+N vs. HP Output Power	<a href="#">Figure 21 on page 29</a>
Frequency Response- S/PDIF Input to HP Output @ 0dBFS	<a href="#">Figure 22 on page 29</a>
THD+N - S/PDIF Input to HP Output	<a href="#">Figure 23 on page 29</a>
Dynamic Range- S/PDIF Input to HP Output @ -60dBFS	<a href="#">Figure 24 on page 29</a>

**Table 1. SPDIF In to Headphone or Line Out Performance Plots**



### 3.2 SPDIF In to Stereo Speaker Out

The CS43L22's stereo differential PWM speaker output performance can be tested by loading the “**SPDIF In to Stereo Speaker Out**” quick setup file provided with the software package. The script configures the digital clock and data signal routing on the board as shown in [Figure 2](#).

Stereo output jacks J6 and J18 can be used to monitor filtered PWM output for measurement purposes. The figure shows how a real speaker or a speaker model should attach to the binding posts during performance tests. Digital S/PDIF input can be provided on the optical (OPT2) or RCA (J68) jacks. Refer to [Section 4 on page 11](#) for details on software configuration.

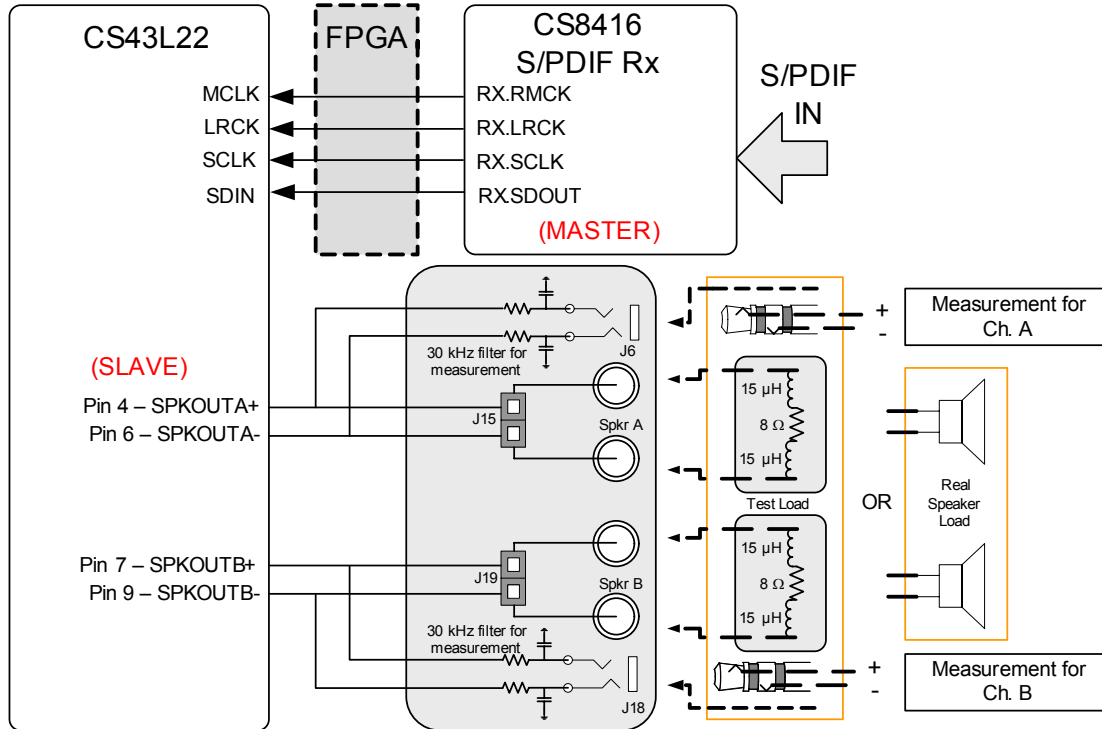

**Figure 2. SPDIF In to Stereo Speaker Out**

[Table 2](#) shows the expected performance characteristics one should expect when using the CDB43L22 for SPDIF In to Stereo Speaker Out measurements.

Plot	Location
FFT - S/PDIF In to Speaker Out @ 0 dBFS	<a href="#">Figure 25 on page 30</a>
FFT - S/PDIF In to Speaker Out @ -60 dBFS	<a href="#">Figure 26 on page 30</a>
Frequency Response- S/PDIF In to Speaker Out	<a href="#">Figure 27 on page 30</a>
THD+N - S/PDIF In to Speaker Out	<a href="#">Figure 28 on page 30</a>
THD+N vs. Output Power- S/PDIF In to Speaker Out	<a href="#">Figure 29 on page 30</a>

**Table 2. SPDIF In to Stereo Speaker Out Performance Plots**

### 3.3 SPDIF In to Mono Speaker Out

The CS43L22's mono differential PWM speaker output performance can be tested by loading the “**SPDIF In to Mono Speaker Out**” quick setup file provided with the software package. The script configures the digital clock and data signal routing on the board as shown in [Figure 2](#).

Stereo output jacks J6 and J18 can be used to monitor filtered PWM output for measurement purposes. The figure shows how a real speaker or a speaker model should attach to the binding posts during performance tests. Please note how **ONLY** the tip from the stereo jacks is used to attach the mono differential channel to the measurement device. Digital S/PDIF input can be provided on the optical (OPT2) or RCA (J68) jacks. Refer to [Section 4 on page 11](#) for details on software configuration.

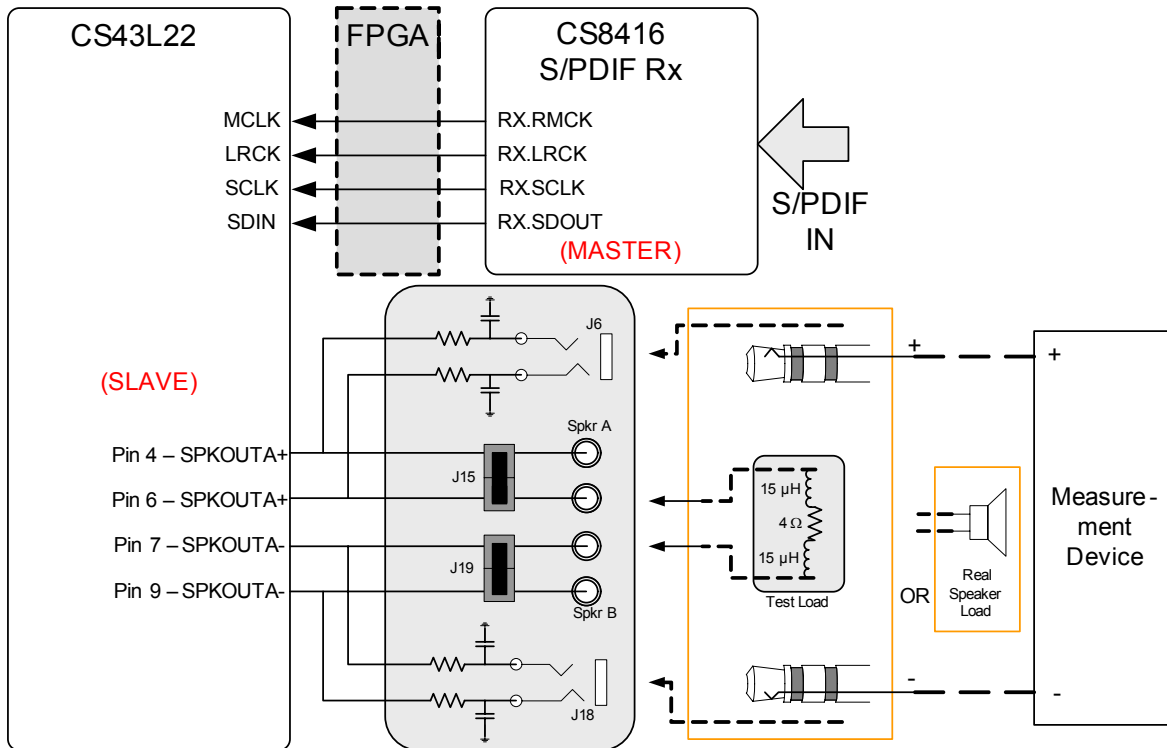

**Figure 3. SPDIF In to Mono Speaker Out**

[Table 3](#) shows the expected performance characteristics one should expect when using the CDB43L22 for SPDIF In to Mono Speaker Out measurements.

Plot	Location
THD+N vs. Output Power- S/PDIF In to Speaker Out	<a href="#">Figure 30 on page 30</a>

**Table 3. SPDIF In to Mono Speaker Out Performance Plots**

## 4. SOFTWARE MODE CONTROL

The CDB43L22 may be used with the Microsoft Windows®-based FlexGUI graphical user interface, allowing software control of the CS43L22, FPGA and CS8416 registers. The latest control software may be downloaded from [www.cirrus.com/mssoftware](http://www.cirrus.com/mssoftware). Step-by-step instructions for setting up the FlexGUI are provided as follows:

1. Download and install the FlexGUI software as instructed on the Website.
2. Connect and apply power to the +5.0 VP binding post.
3. Connect the CDB to the host PC using a USB cable.
4. Launch the Cirrus FlexGUI. *Once the GUI is launched successfully, all registers are set to their default reset state.*
5. Refresh the GUI by clicking on the "Update" button. *The default state of all registers are now visible.*

For standard set-up:

6. Set up the signal routing in the "Board Configuration" tab as desired.
7. Set up the CS43L22 in the "Passthrough, Power and Serial Audio Interface Configuration", "DSP Engine" and "Analog and PWM Output Volume" tab as desired.
8. Begin evaluating the CS43L22.

**For quick set-up**, the CDB43L22 may, alternatively, be configured by loading a predefined sample script file:

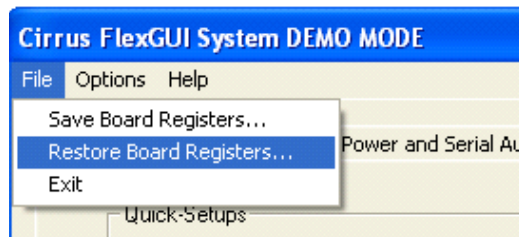

9. On the File menu, click "Restore Board Registers..."
10. Browse to Boards\CDB43L22\Scripts\.
11. Choose any one of the provided scripts to begin evaluation.

To create personal scripts files:

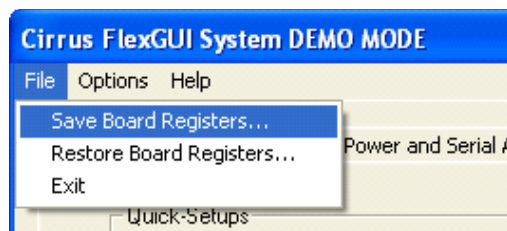

12. On the File menu, click "Save Board Registers..."
13. Enter any name that sufficiently describes the created setup.
14. Choose the desired location and save the script.
15. To load this script, follow the instructions from step 9 above.

## 4.1 Board Configuration Tab

The “Board Configuration” tab provides high-level control of signal routing on the CDB43L22. This tab also includes basic controls that allow “quick setup” in a number of simple board configurations. Status text detailing the CS43L22’s specific configuration appears directly below the associated control. This text may change depending on the setting of the associated control. A description of each control group is outlined below:

*CS43L22 Basic Configuration* - Includes controls for configuring the interface format, clocking functions and analog input signal routing in the CS43L22. See [Section 4.2](#) through [Section 4.4](#) for more controls in the CS43L22.

*CS8416 S/PDIF Receiver Control* - Register controls for setting up the CS8416.

*Clock Source and Routing Selection* - Includes controls used to configure the value and source of the master, frame and bit clocks which are sent to the CS43L22.

*Update* - Reads all registers in the FPGA, CS43L22 and the CS8416 and shows the current values in the GUI.

*Reset* - Resets FPGA to default routing configuration.

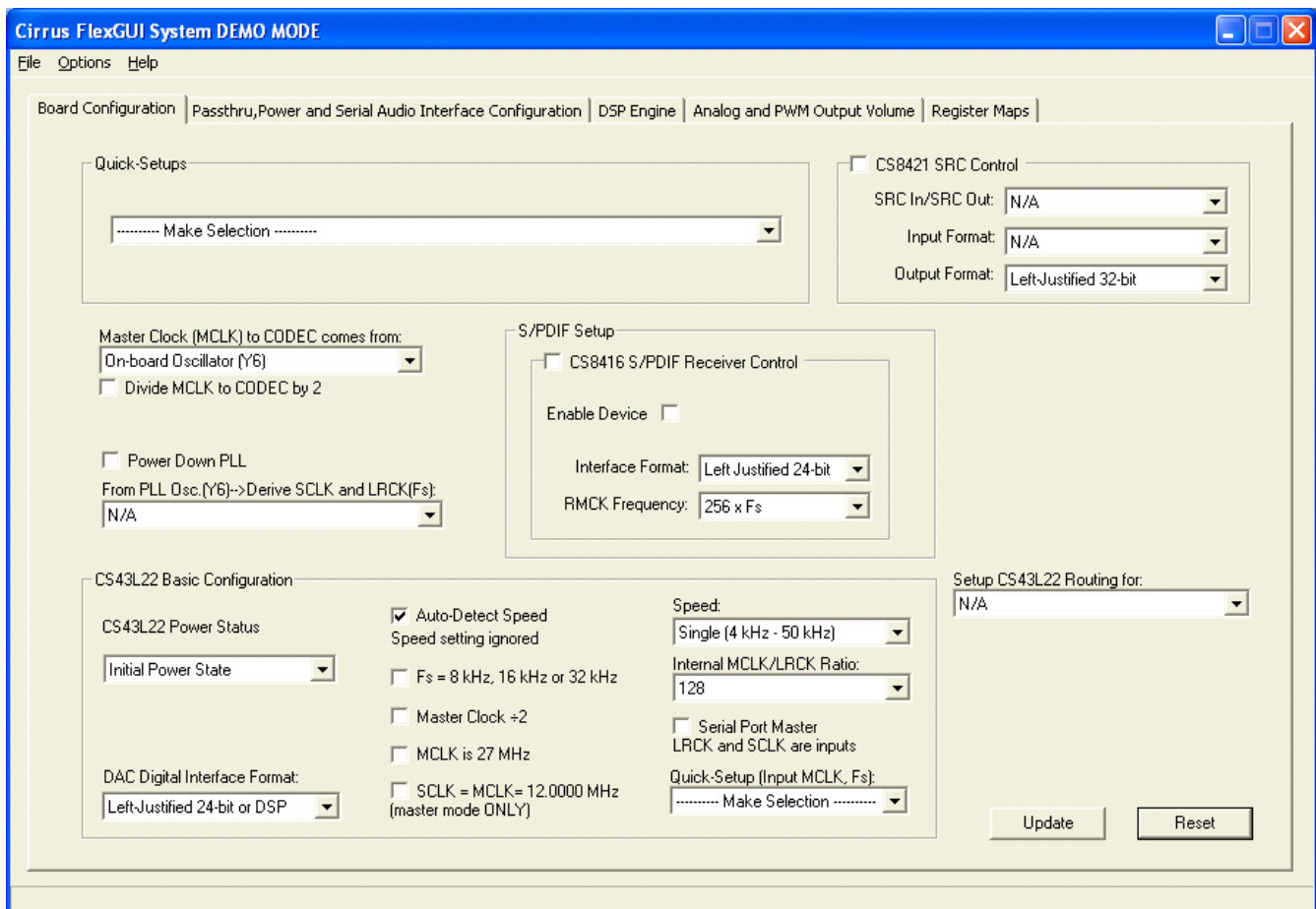

**Figure 4. Board Configuration Tab**

## 4.2 Passthrough, Power and Serial Audio Interface Configuration Tab

The “Passthrough, Power and Serial Audio Interface Configuration” Tab provides high-level control of the CS43L22 passthrough, power control and serial port register settings. Status text detailing the CS43L22’s specific configuration is shown in parenthesis or appears directly below the associated control. This text will change depending on the setting of the associated control. A description of each group is outlined below. See the CS43L22 data sheet for complete register descriptions.

*Power Control* - Register controls for powering down each section within the CS43L22.

*Analog Passthrough Configuration* - Controls for the input mixer (summing amp) and analog passthrough settings.

*Serial Port Configuration* - Controls for all settings related to the serial I/O data and clocks on the board.

*Update* - Reads all registers in the CS43L22 and reflects the current values in the GUI.

*Reset* - Resets the CS43L22.

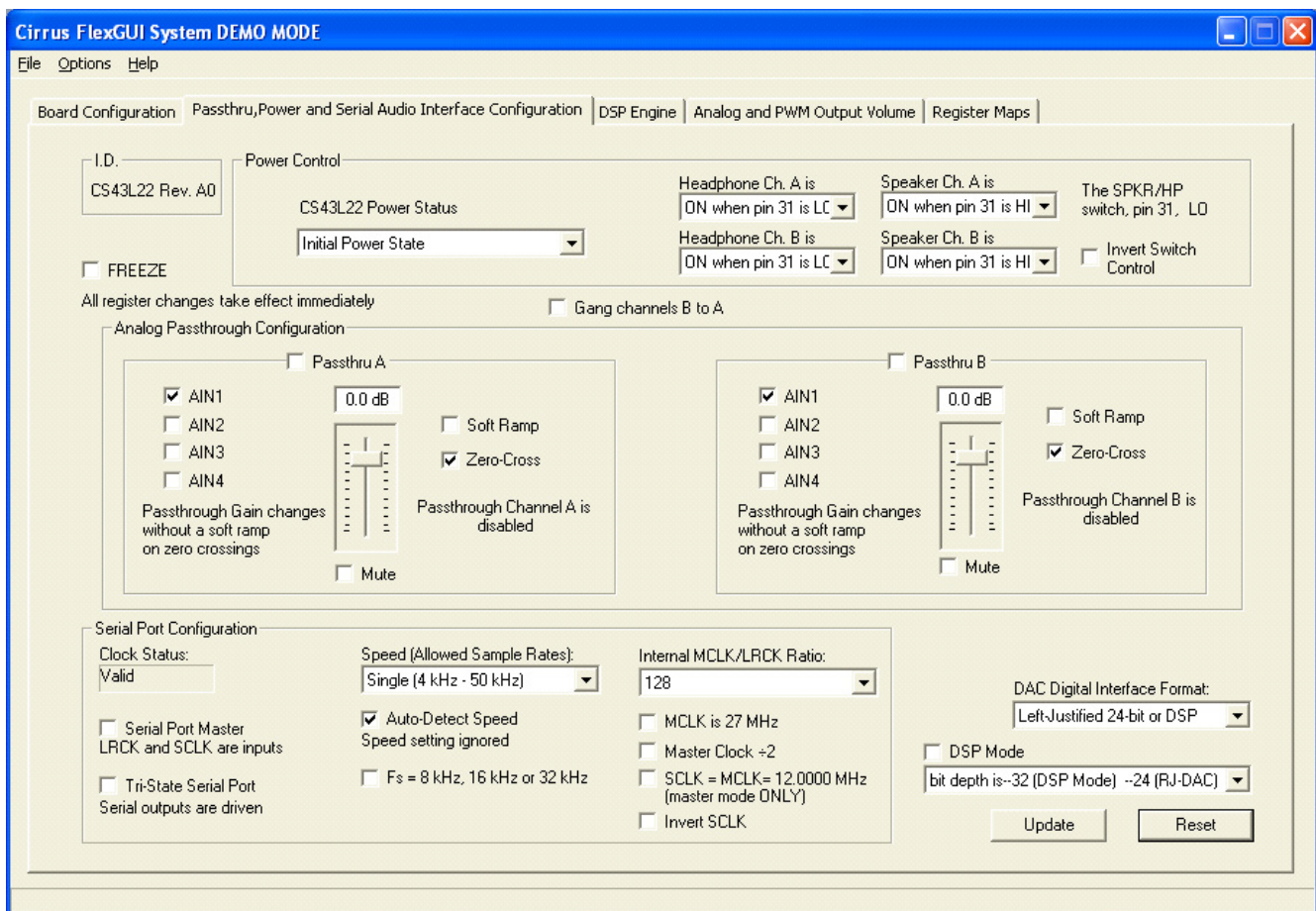

**Figure 5. Passthrough, Power and Serial Audio Interface Configuration Tab**



### 4.3 DSP Engine Tab

The “DSP Engine” tab provides high-level control of the SDIN (PCM) data volume level, the PCM mix volume level and the overall DAC/PWM channel volume level. DAC/PWM channel Limiter, Tone Control and Beep Generator control functions are also provided. Status text detailing the CS43L22’s specific configuration is shown in parenthesis or inside the control group of the affected control. This text will change depending on the setting of the associated control. A description of each control group is outlined below. See the CS43L22 datasheet for complete register descriptions.

*Digital Volume Control* - Digital volume controls and adjustments for the SDIN data and overall channel volume. Mute, gang, invert and de-emphasis functions are also available.

*Limiter* - Configuration settings for the Limiter.

*Tone Control* - Bass and treble volume controls and filter corner frequencies.

*Beep Generator* - On/Off time, frequency, volume, mix and repeat beep functions.

*Update* - Reads all registers in the CS43L22 and reflects the current values in the GUI.

*Reset* - Resets the CS43L22.

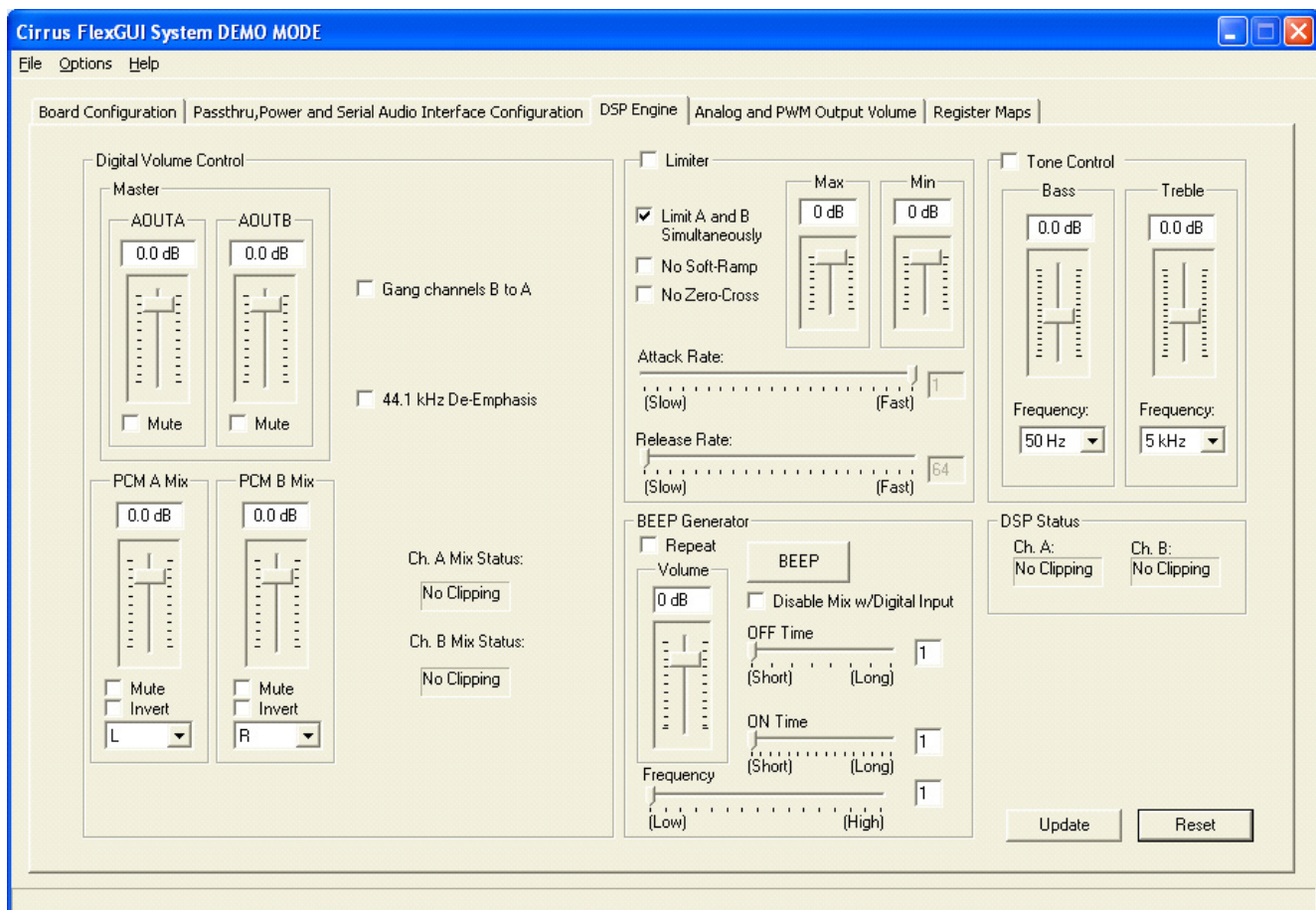

**Figure 6. DSP Engine Tab**

#### 4.4 Analog and PWM Output Volume Tab

The “Analog and PWM Output Volume” tab provides high-level control of the CS43L22 PWM outputs, HP/Line output volume levels and charge pump frequency. This tab also provides controls for the PWM output including speaker volume and PWM gain. Temperature and Battery monitoring controls for the PWM/Speaker outputs are also on this tab. Status text detailing the CS43L22’s specific configuration is shown in read-only edit boxes, in parenthesis or appears directly below the associated control. This text will change depending on the setting of the associated control. A description of each control group is outlined below. See the CS43L22 datasheet for complete register descriptions.

*Headphone/Line Analog Output* - Volume controls and adjustments for the DAC channel (outside of the DSP). The modulation index and gain settings make up the parameters that determine the full scale headphone/line output level.

*PWM Output* - Volume, mute, power down and other functional controls for the PWM speaker outputs.

*Temperature and Battery Monitor/Control* - Battery Compensation, Thermal Foldback, Temperature Shutdown and Battery Monitor for the PWM/Speaker outputs.

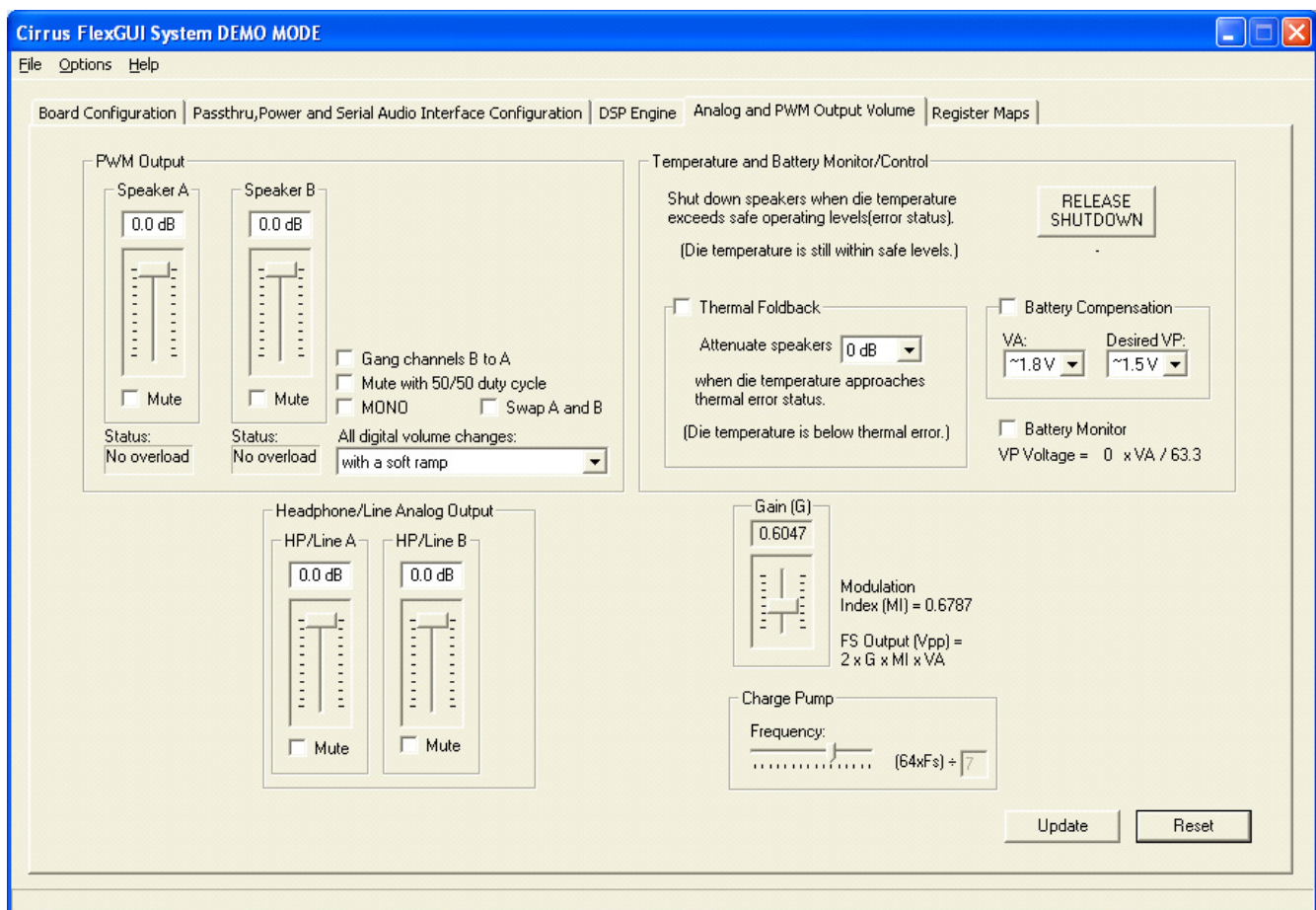
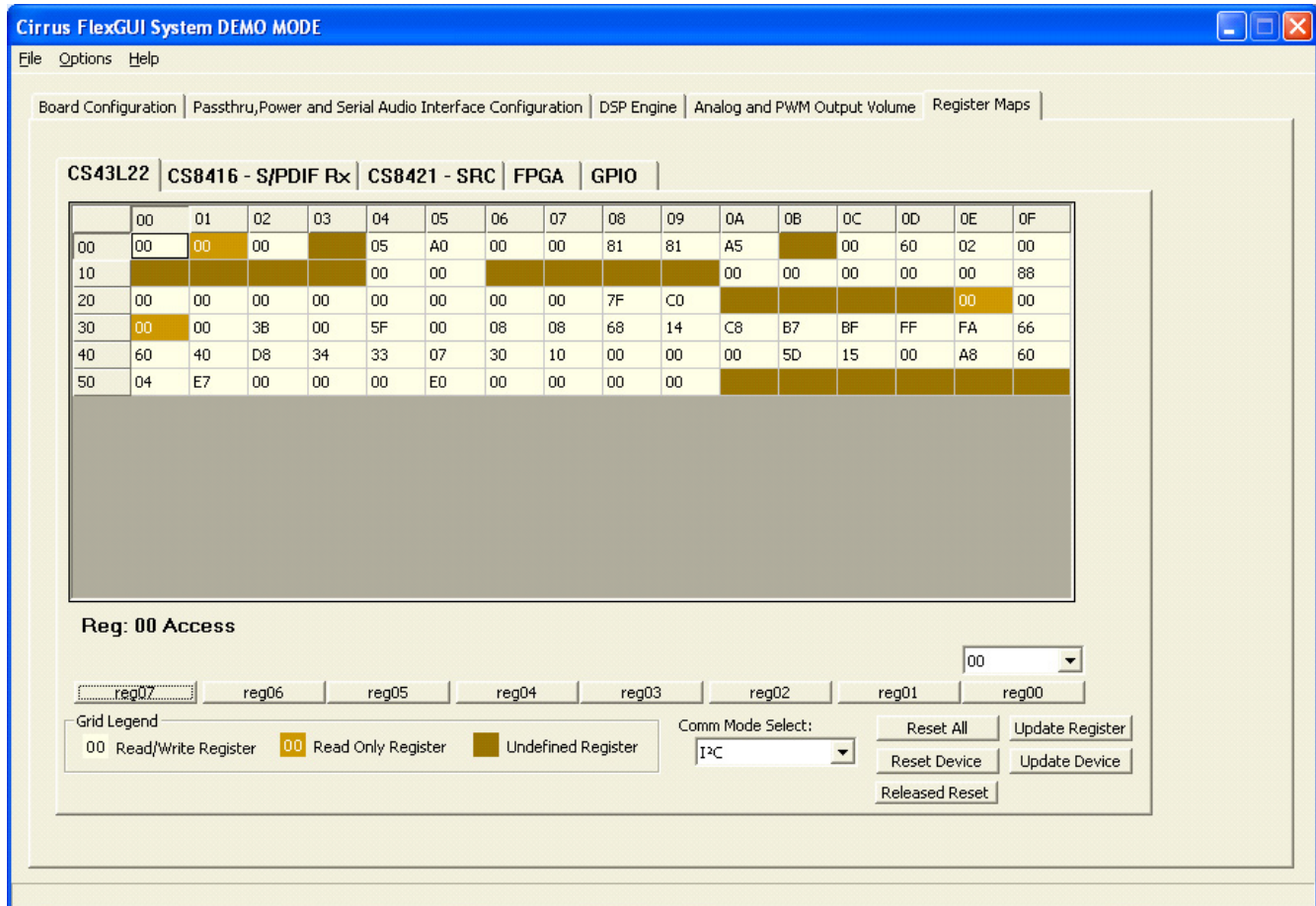

Figure 7. Analog and PWM Output Volume Tab



## 4.5 Register Maps Tab

The Register Maps tabs provide low-level control of the CS43L22, CS8416, CS8421, FPGA and GPIO register settings. Register values can be modified bit-wise or byte-wise. “Left-clicking” on a particular register accesses that register and shows its contents at the bottom. The user can change the register contents by using the push-buttons, by selecting a particular bit and typing in the new bit value or by selecting the register in the map and typing in a new hex value.



**Figure 8. Register Maps Tab - CS43L22**

## 5. SYSTEM CONNECTIONS AND JUMPERS

CONNECTOR	REF	INPUT/OUTPUT	SIGNAL PRESENT
VP	J35	Input	+2.7 V to +5.25 V Power Supply.
GND	J4	Input	Ground Reference.
USB	J94	Input/Output	USB connection to PC for I <sup>2</sup> C control port signals.
S/PDIF OPTICAL IN	OPT3	Input	CS8416 digital audio input via optical cable.
S/PDIF COAX IN	J61	Input	CS8416 digital audio input via coaxial cable.
I/O Header	J8	Input/Output	I/O for Clocks & Data directly to/from the CS43L22.
S/W CONTROL	J109	Input/Output	I/O for external I <sup>2</sup> C control port signals.
MICRO JTAG	J110	Input/Output	I/O for programming the micro controller (U84).
FPGA JTAG	J75	Input/Output	I/O for programming the FPGA (U5).
MICRO RESET	S4	Input	Reset for the micro controller (U84).
FPGA PROGRAM	S2	Input	Reload Xilinx program into the FPGA from Flash (U14).
H/W BOARD RESET	S1	Input	Reset for the CS43L22(U1).
AIN1	J33	Input	1/8" audio jacks for analog passthrough input signal to CS43L22.
AIN2	J37	Input	
AIN3	J45	Input	1/8" audio jacks for Line or MIC analog passthrough input signals to CS43L22.
AIN4	J50	Input	
A(RC LPF)	J6	Output	30 kHz LPF version of the signal on speaker binding posts (Used for measurement purposes only).
B(RC LPF)	J18	Output	
SPEAKER A-	J60	Output	Full Bridge speaker outputs.
SPEAKER A+	J59	Output	
SPEAKER B-	J101	Output	
SPEAKER B+	J99	Output	
HP/Line Output	J40	Output	Stereo 1/8" jack for line outputs. When headphones are plugged in to HP Connect (on J21), this output may be used for performance measurement.
HP Connect	J21	Output	Stereo headphone jack for Headphone outputs.
I/O HDR	J78	Input/Output	I/O for clocks and input for DAC SDIN. Signals are passed through the FPGA for muxing with the S/PDIF input.

**Table 4. System Connections**

## 6. JUMPER SETTINGS

JMP	LABEL	PURPOSE	POSITION	FUNCTION SELECTED
J31	VL	Selects source of voltage for the VL supply	*+1.8V	Voltage source is +1.8 V regulator.
			+2.5V	Voltage source is +2.5 V regulator.
			+3.3V	Voltage source is +3.3 V regulator.
J36	VA_HP	Selects source of voltage for the VA_HP supply	*+1.8V	Voltage source is +1.8 V regulator.
			+2.5V	Voltage source is +2.5 V regulator.
J25	VA	Selects source of voltage for the VA supply	*+1.8V	Voltage source is +1.8 V regulator.
			+2.5V	Voltage source is +2.5 V regulator.
J28	VD	Selects source of voltage for the VD supply	*+1.8V	Voltage source is +1.8 V regulator.
			+2.5V	Voltage source is +2.5 V regulator.
J52 J47 J74 J53	VL +VA_HP VA VD	Current Measurement	*SHUNTED	1 $\Omega$ series resistor is shorted.
J48	VP		Current measurement	OPEN
J13 J14	[No Label]	Applies a filtered or a non-filtered version of the SPKA- signal to J60	*1 - 2	SPKOUTA- output routed to J60.
			2 - 3	SPKOUTA- output not routed to J60.
J16 J17	[No Label]	Applies a filtered or a non-filtered version of the SPKA+ signal to J59	*1 - 2	SPKOUTA+ output routed to J59.
			2 - 3	SPKOUTA+ output not routed to J59.
J11 J12	[No Label]	Applies a filtered or a non-filtered version of the SPKB- signal to J101	*1 - 2	SPKOUTB- output routed to J101.
			2 - 3	SPKOUTB- output not routed to J101.
J20 J23	[No Label]	Applies a filtered or a non-filtered version of the SPKA- signal to J99	*1 - 2	SPKOUTB+ output routed to J99.
			2 - 3	SPKOUTB+ output not routed to J99.
J15	MONO	Applies a short between SPKOUT A+ and A-. (Used only <b>after</b> MONO function is enabled in the CS43L22)	*OPEN	Channel A+ and A- to J59 and J60 respectively.
			SHUNTED	Channel + to J59 and J60 respectively.
J19	MONO	Applies a short between SPKOUT B+ and B-. (Used only <b>after</b> MONO function is enabled in the CS43L22)	*OPEN	Channel B+ and B- to J99 and J101 respectively.
			SHUNTED	Channel - to J99 and J101 respectively.
J3	HP B LOAD	Selects 32 or 16 $\Omega$ load for HP/LINE_OUTB (DAC out)	1 - 2	16 $\Omega$ load selected.
			2 - 3	32 $\Omega$ load selected.
J9	HP A LOAD	Selects 32 or 16 $\Omega$ load for HP/LINE_OUTA (DAC out)	1 - 2	16 $\Omega$ load selected.
			2 - 3	32 $\Omega$ load selected.
J1	LEFT CH	Selects between a filtered or non filtered version of the HP/LINE_OUTA signal.	1 - 2	Non-filtered HP/LINE_OUTA to HP/Line Jack.
			*2 - 3	Filtered HP/LINE_OUTA to HP/Line Jack.
J2	RIGHT CH	Selects between a filtered or non filtered version of the HP/LINE_OUTB signal.	1 - 2	Non-filtered HP/LINE_OUTA to HP/Line Jack.
			*2 - 3	Filtered HP/LINE_OUTA to HP/Line Jack.
J22	HP DETECT	Selects the control source for the SPKR/HP pin	1 - 2	FPGA.
			*2 - 3	HP Jack.
J34	Board Power	Selects either USB or External +5 V power for the board	1 - 2	External +5 V power.
			*2 - 3	USB generated +5 V power. (USB hub must be capable of greater than 300 mA)
J5	VP	Selects either External or Battery power for VP and for the buck regulators that powers VA, VA_HP and VD	*1 - 2	External from J35.
			2 - 3	Battery from BT1-BT3 (bottom side)

**Table 5. Jumper Settings**

### 7. CDB43L22 BLOCK DIAGRAM

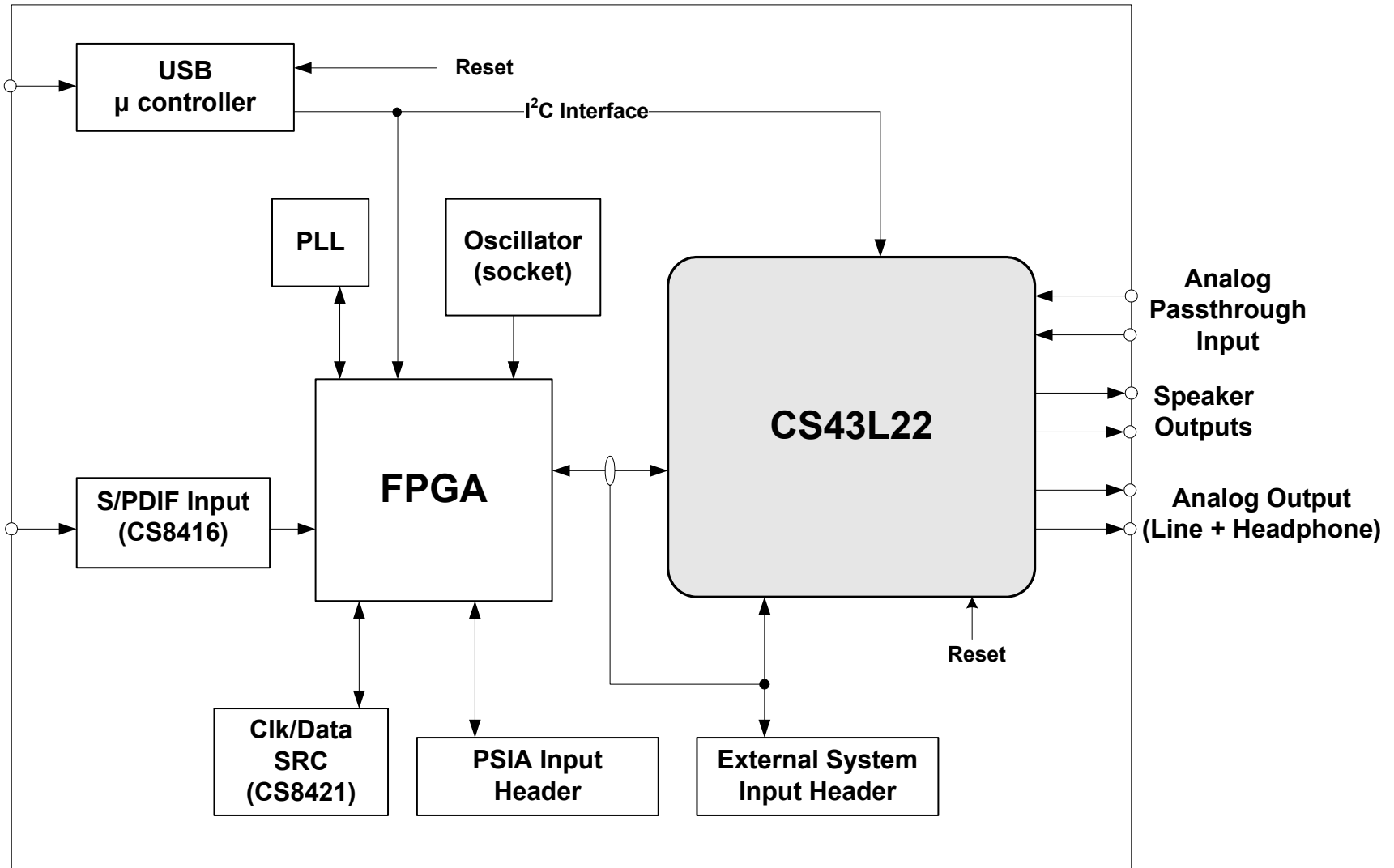
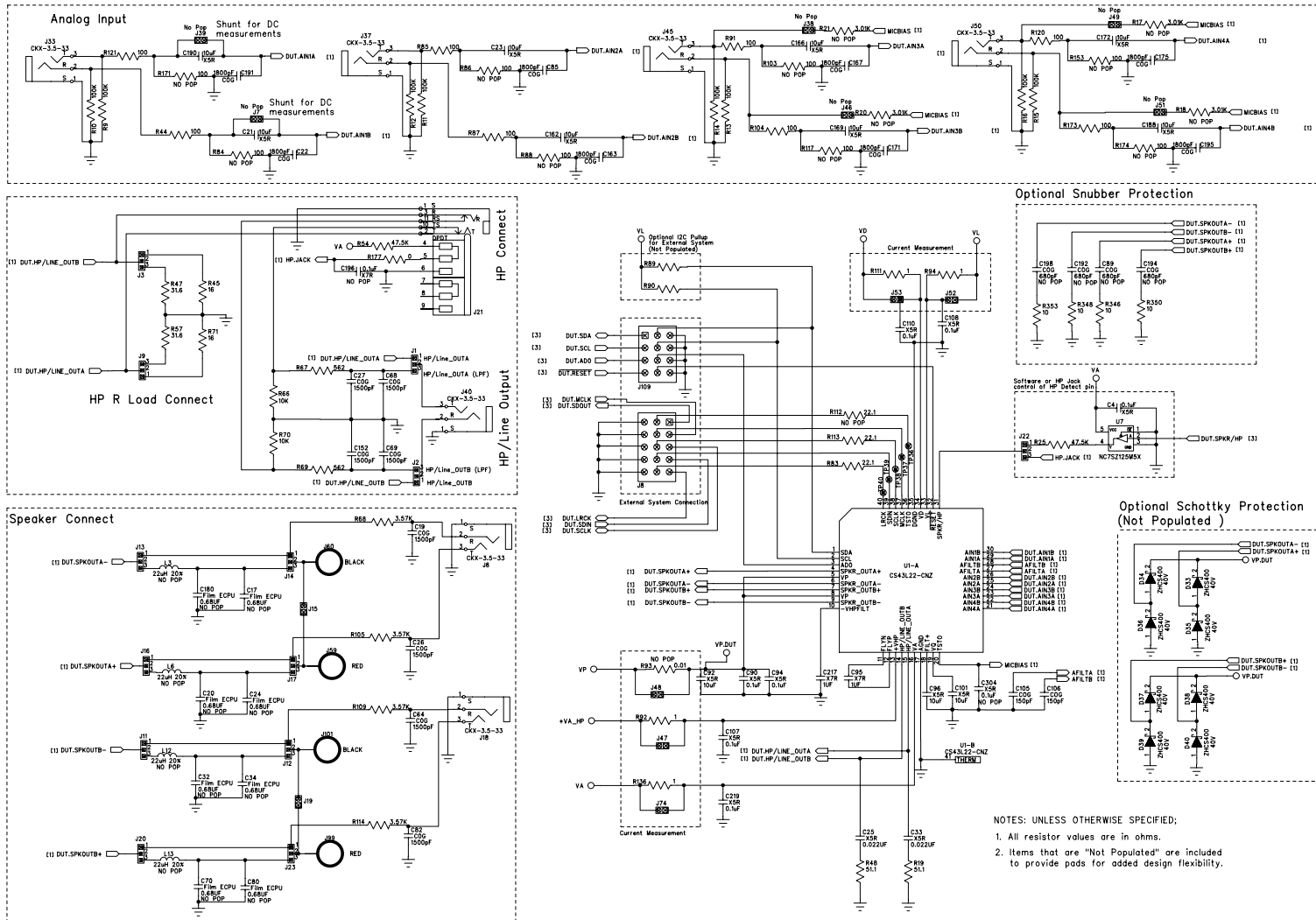

Figure 9. Block Diagram

# 8. CDB43L22 SCHEMATICS



NOTES: UNLESS OTHERWISE SPECIFIED:  
 1. All resistor values are in ohms.  
 2. Items that are "Not Populated" are included to provide pads for added design flexibility.

Figure 10. CS43L22 & Analog I/O (Schematic Sheet 1)





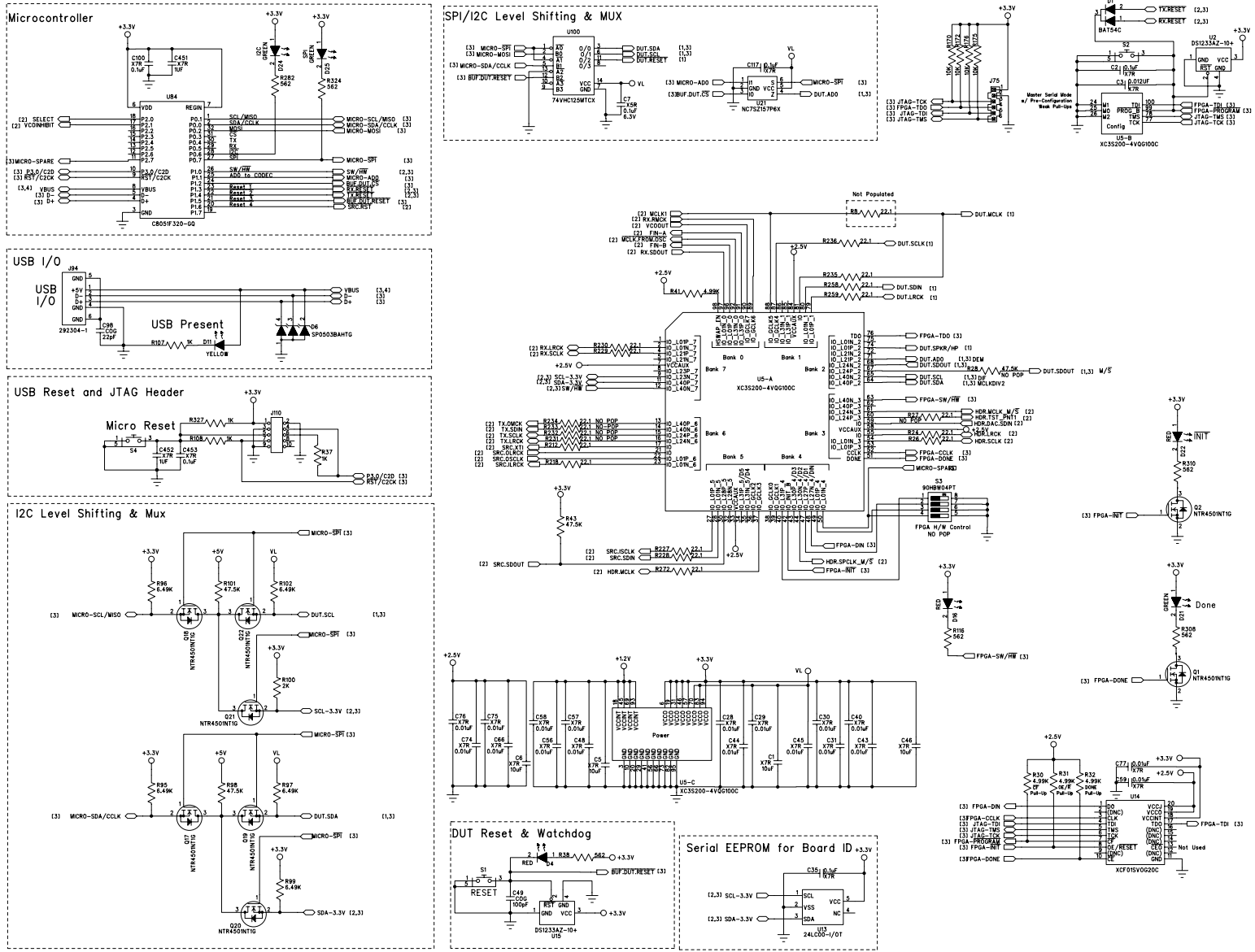
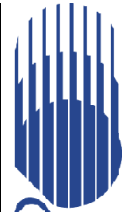

Figure 12. Micro & FPGA Control (Schematic Sheet 3)



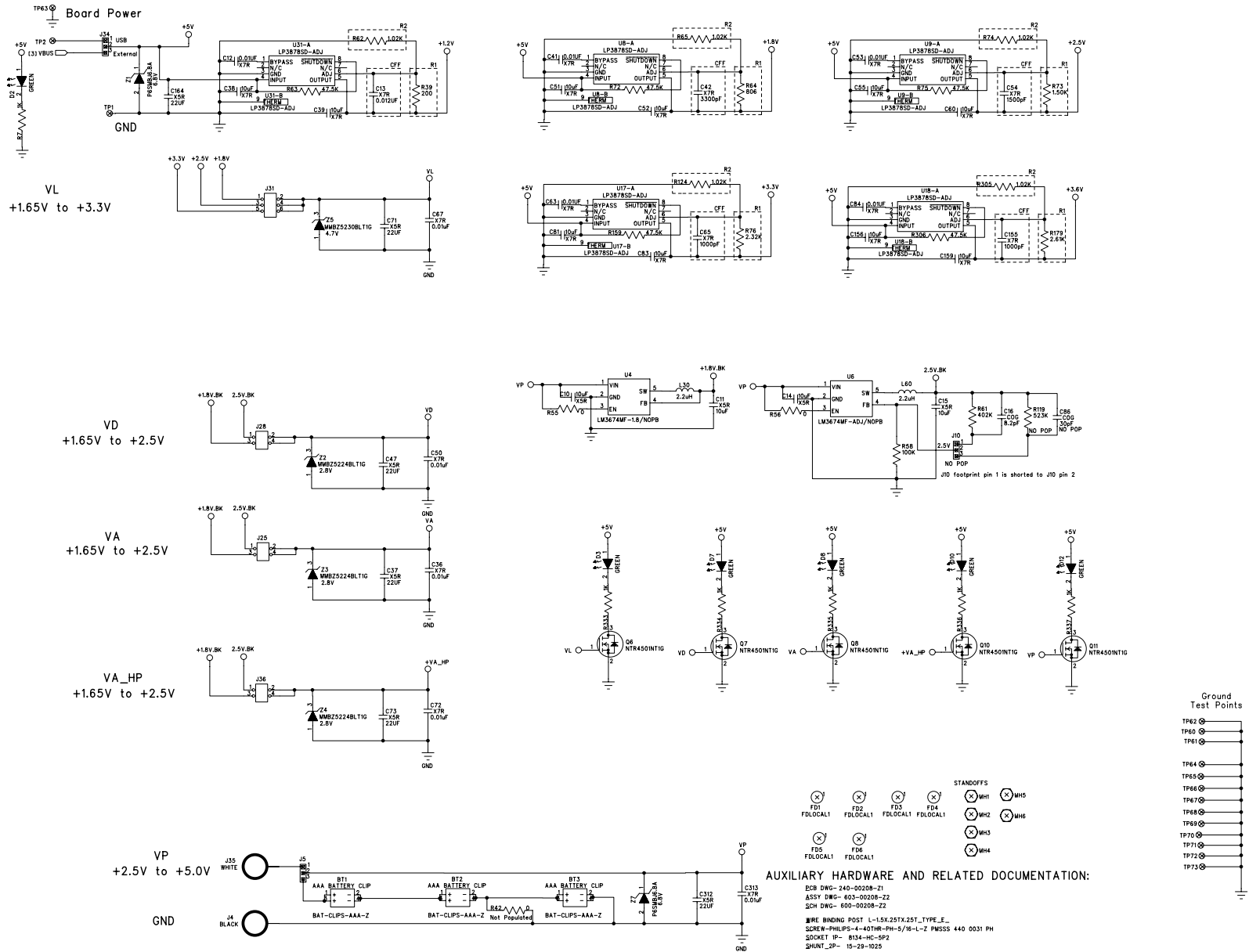

Figure 13. Power (Schematic Sheet 4)



# 9. CDB43L22 LAYOUT

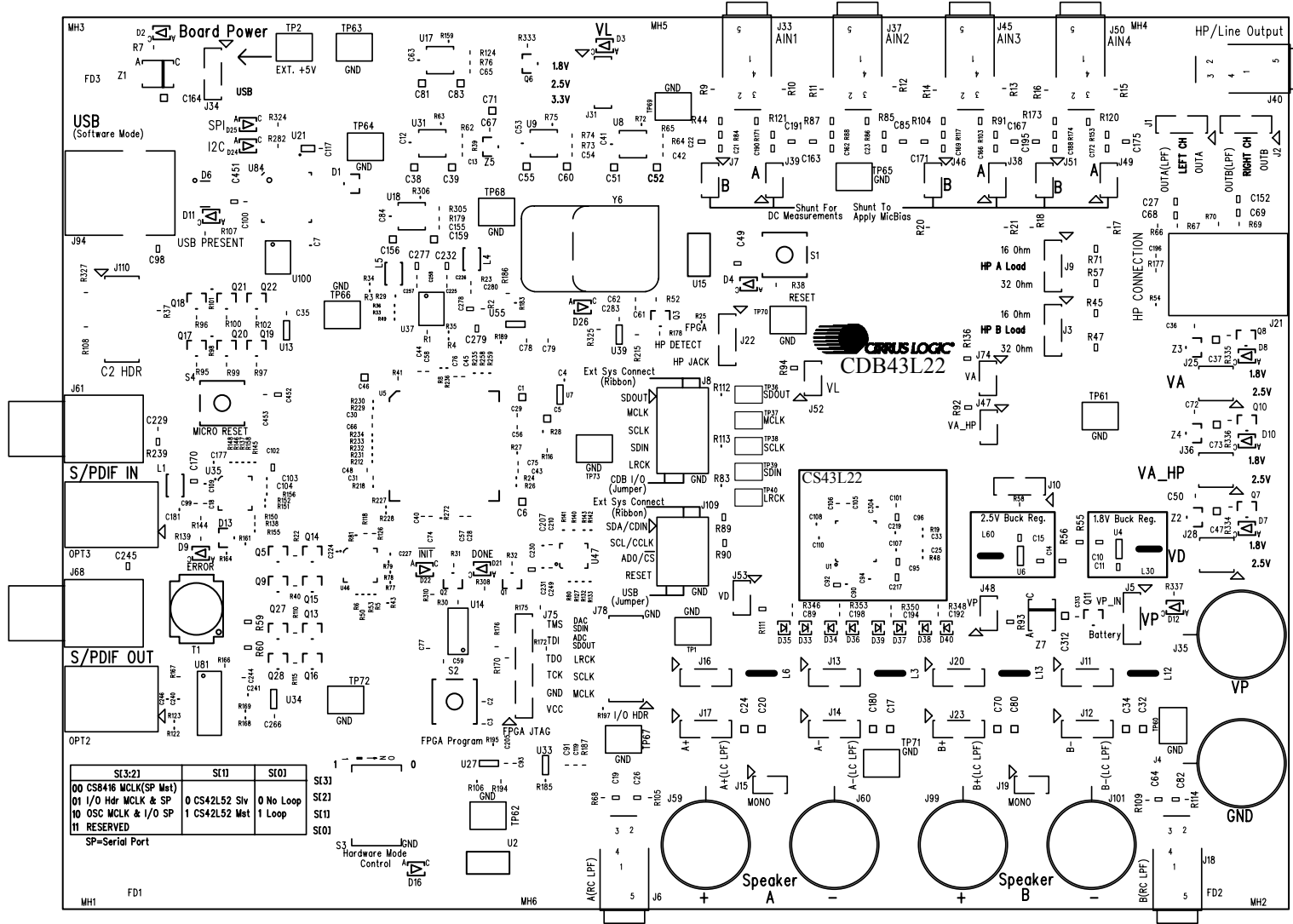

Figure 14. Silk Screen



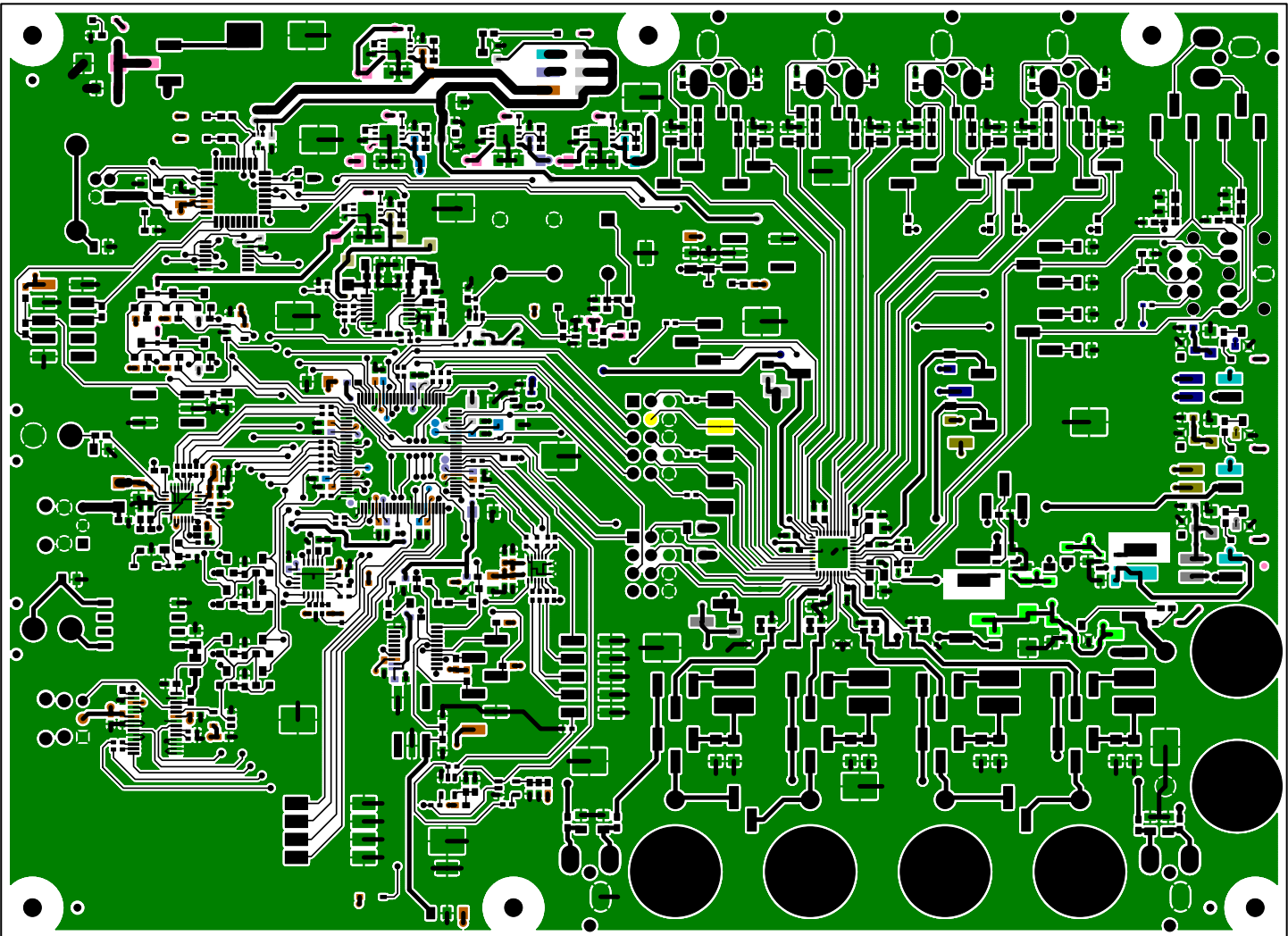

Figure 15. Top-Side Layer

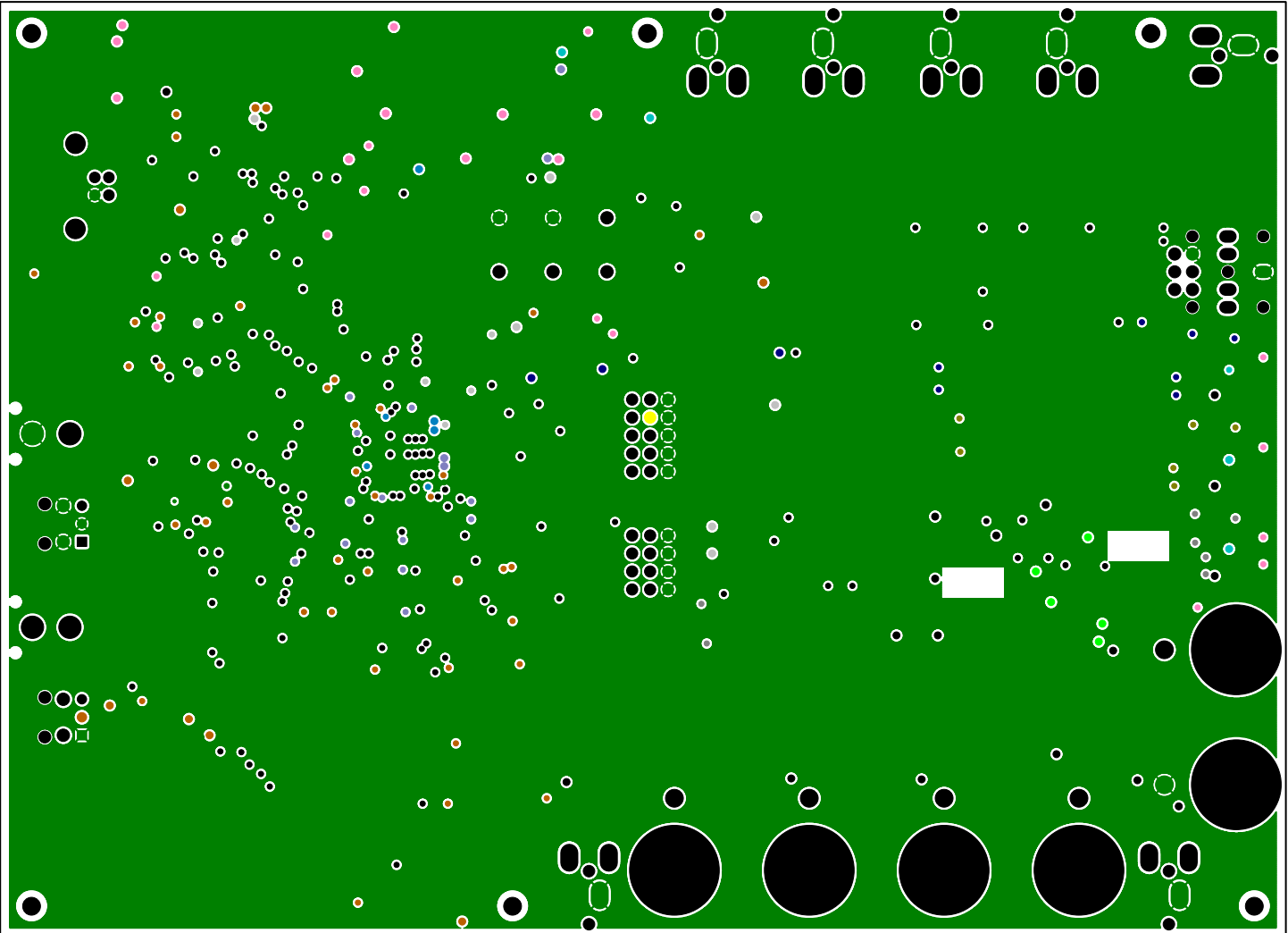
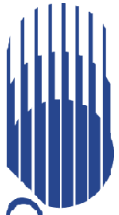

Figure 16. GND (Layer 2)

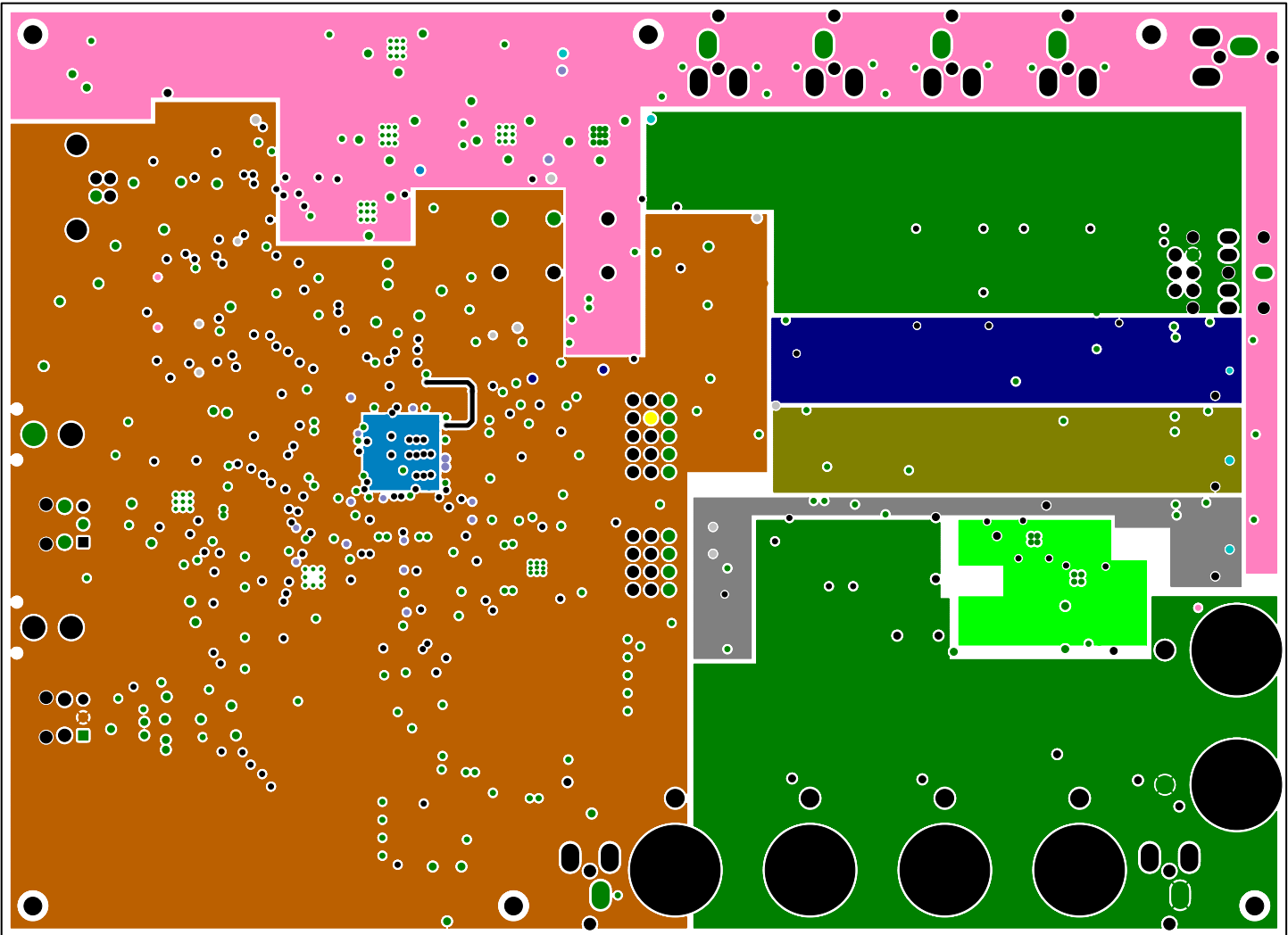

Figure 17. Power (Layer 3)



CIRUS LOGIC®

CDB43L22

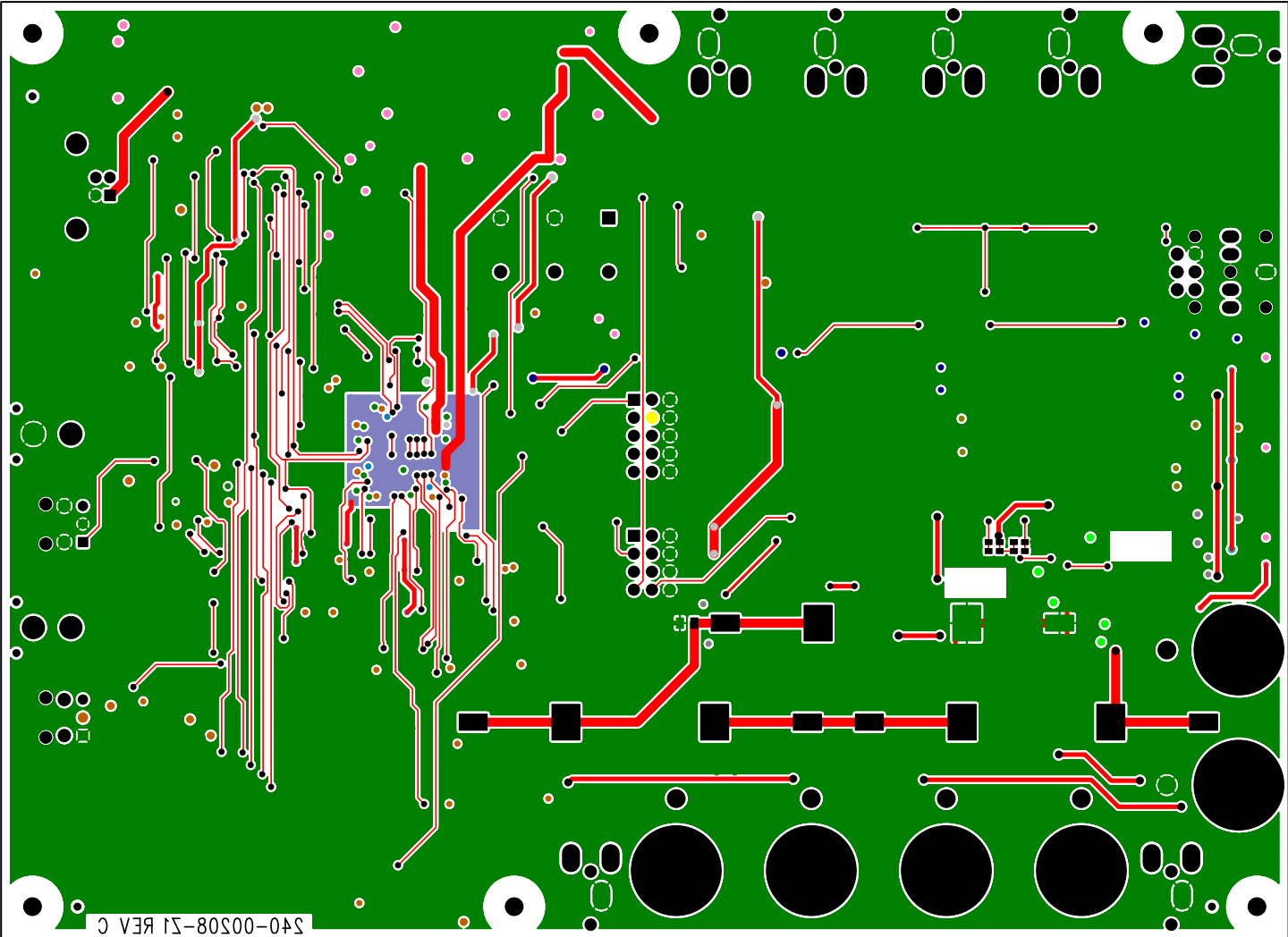

Figure 18. Bottom-Side Layer

## 10.PERFORMANCE PLOTS

Test conditions (unless otherwise specified): Measurement bandwidth is 20 Hz to 20 kHz (unweighted); VA=VD=VA\_HP=1.8V; Sample Frequency = 48 kHz; HP test load:  $R_L = 16 \Omega$ .

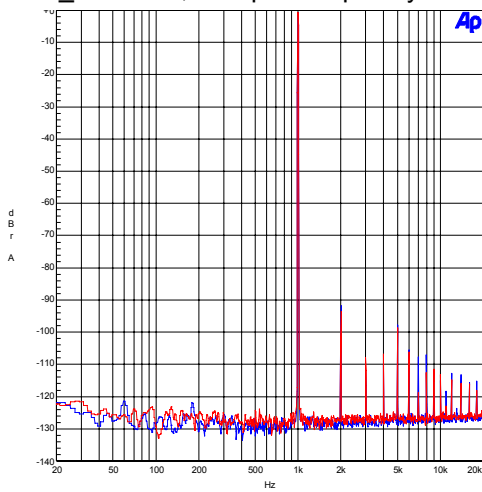

Figure 19. FFT - S/PDIF Input to HP Output @ -1 dBFS

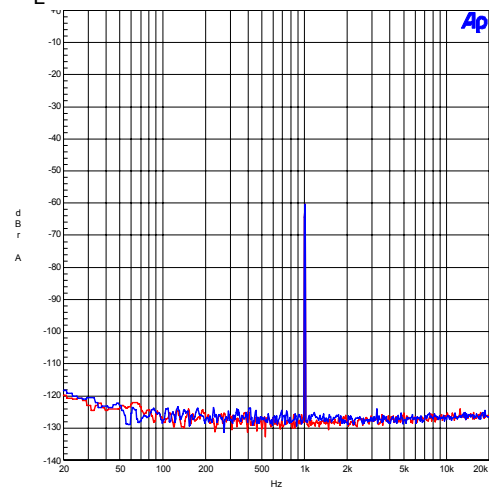

Figure 20. FFT - S/PDIF Input to HP Output @ -60 dBFS

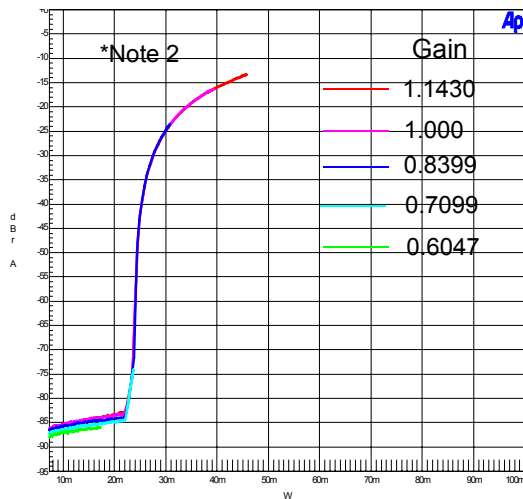

Figure 21. THD+N vs. HP Output Power

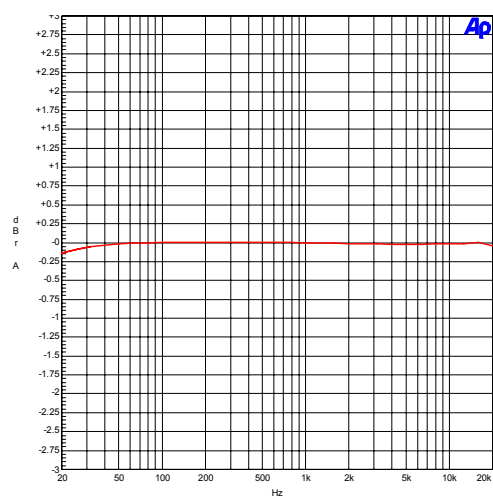

Figure 22. Freq. Resp. - S/PDIF Input to HP Output

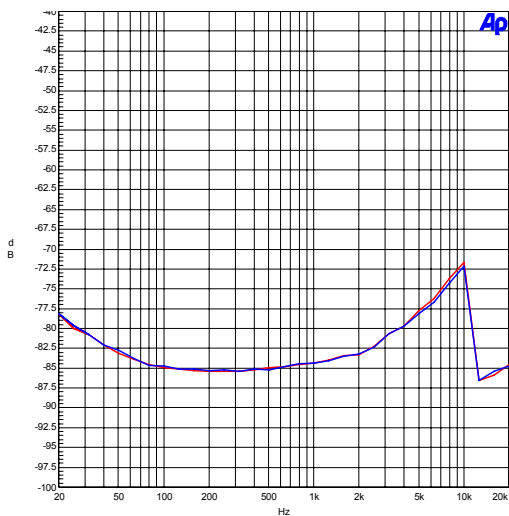

Figure 23. THD+N - S/PDIF Input to HP Output

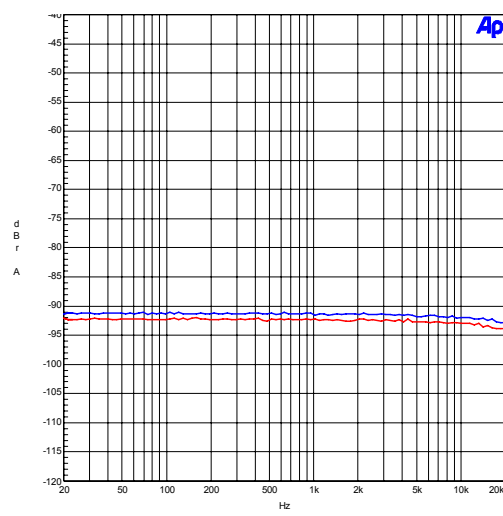
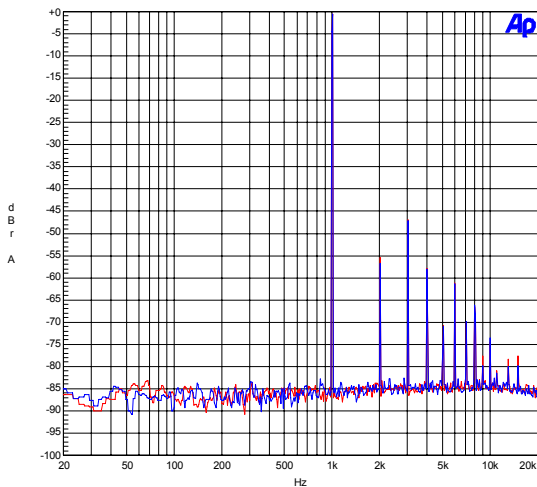
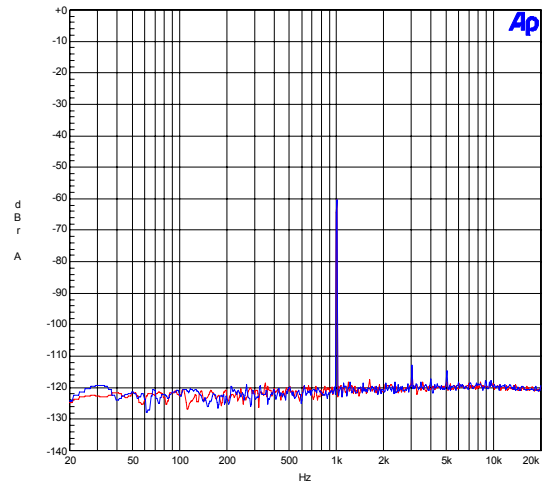
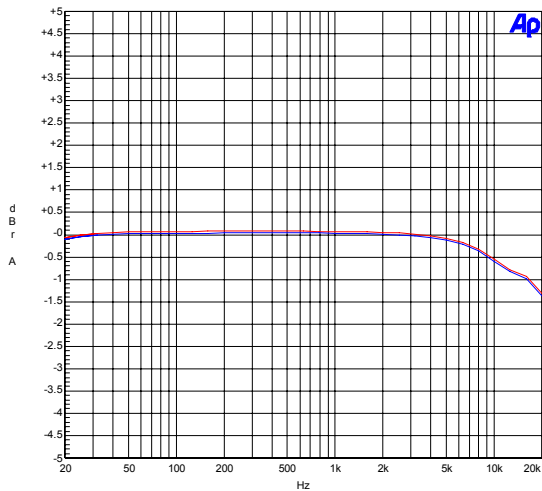
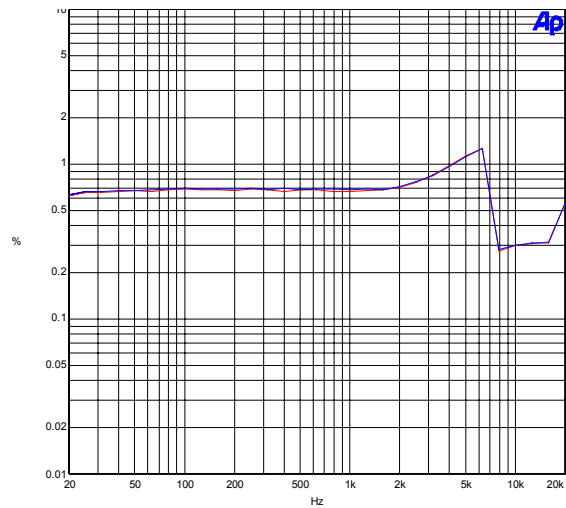
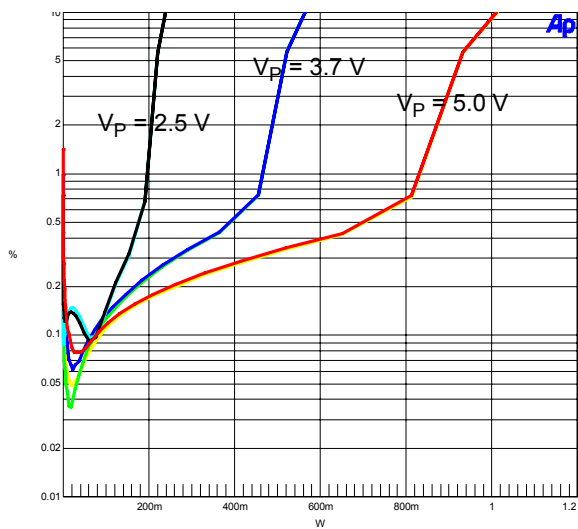
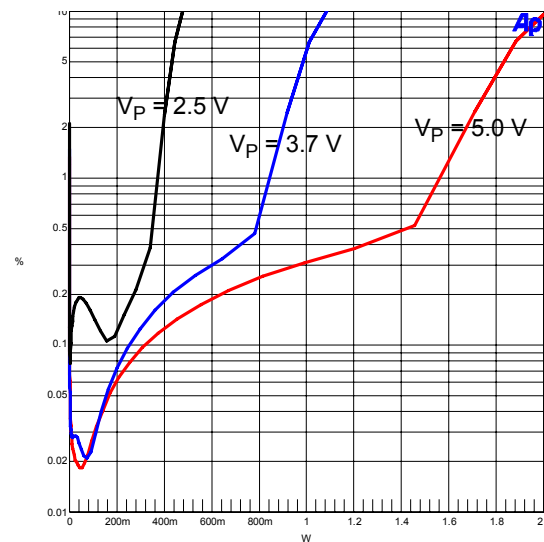

Figure 24. Dynamic Range- S/PDIF Input to HP Output



**Figure 25. FFT - S/PDIF In to Speaker Out @ 0 dBFS**

**Figure 26. FFT - S/PDIF In to Speaker Out @ -60 dBFS**

**Figure 27. Frequency Response - S/PDIF In to Speaker Out**

**Figure 28. THD+N - S/PDIF In to Speaker Out**

**Figure 29. THD+N vs. Output Power (Stereo)**

**Figure 30. THD+N vs. Output Power (Mono)**

---

## 11. REVISION HISTORY

Revision	Changes
DB1	Initial Release

---

### Contacting Cirrus Logic Support

For all product questions and inquiries, contact a Cirrus Logic Sales Representative.

To find the one nearest you, go to [www.cirrus.com](http://www.cirrus.com).

---

#### IMPORTANT NOTICE

Cirrus Logic, Inc. and its subsidiaries ("Cirrus") believe that the information contained in this document is accurate and reliable. However, the information is subject to change without notice and is provided "AS IS" without warranty of any kind (express or implied). Customers are advised to obtain the latest version of relevant information to verify, before placing orders, that information being relied on is current and complete. All products are sold subject to the terms and conditions of sale supplied at the time of order acknowledgment, including those pertaining to warranty, indemnification, and limitation of liability. No responsibility is assumed by Cirrus for the use of this information, including use of this information as the basis for manufacture or sale of any items, or for infringement of patents or other rights of third parties. This document is the property of Cirrus and by furnishing this information, Cirrus grants no license, express or implied under any patents, mask work rights, copyrights, trademarks, trade secrets or other intellectual property rights. Cirrus owns the copyrights associated with the information contained herein and gives consent for copies to be made of the information only for use within your organization with respect to Cirrus integrated circuits or other products of Cirrus. This consent does not extend to other copying such as copying for general distribution, advertising or promotional purposes, or for creating any work for resale.

CERTAIN APPLICATIONS USING SEMICONDUCTOR PRODUCTS MAY INVOLVE POTENTIAL RISKS OF DEATH, PERSONAL INJURY, OR SEVERE PROPERTY OR ENVIRONMENTAL DAMAGE ("CRITICAL APPLICATIONS"). CIRRUS PRODUCTS ARE NOT DESIGNED, AUTHORIZED OR WARRANTED FOR USE IN AIRCRAFT SYSTEMS, MILITARY APPLICATIONS, PRODUCTS SURGICALLY IMPLANTED INTO THE BODY, AUTOMOTIVE SAFETY OR SECURITY DEVICES, LIFE SUPPORT PRODUCTS OR OTHER CRITICAL APPLICATIONS. INCLUSION OF CIRRUS PRODUCTS IN SUCH APPLICATIONS IS UNDERSTOOD TO BE FULLY AT THE CUSTOMER'S RISK AND CIRRUS DISCLAIMS AND MAKES NO WARRANTY, EXPRESS, STATUTORY OR IMPLIED, INCLUDING THE IMPLIED WARRANTIES OF MERCHANTABILITY AND FITNESS FOR PARTICULAR PURPOSE, WITH REGARD TO ANY CIRRUS PRODUCT THAT IS USED IN SUCH A MANNER. IF THE CUSTOMER OR CUSTOMER'S CUSTOMER USES OR PERMITS THE USE OF CIRRUS PRODUCTS IN CRITICAL APPLICATIONS, CUSTOMER AGREES, BY SUCH USE, TO FULLY INDEMNIFY CIRRUS, ITS OFFICERS, DIRECTORS, EMPLOYEES, DISTRIBUTORS AND OTHER AGENTS FROM ANY AND ALL LIABILITY, INCLUDING ATTORNEYS' FEES AND COSTS, THAT MAY RESULT FROM OR ARISE IN CONNECTION WITH THESE USES.

Cirrus Logic, Cirrus, and the Cirrus Logic logo designs are trademarks of Cirrus Logic, Inc. All other brand and product names in this document may be trademarks or service marks of their respective owners.

°C is a registered trademark of Philips Semiconductor.

Windows is a registered trademark of Microsoft Corporation.

---

# Mouser Electronics

Authorized Distributor

Click to View Pricing, Inventory, Delivery & Lifecycle Information:

[Cirrus Logic:](#)

[CDB43L22](#)

Компания «Life Electronics» занимается поставками электронных компонентов импортного и отечественного производства от производителей и со складов крупных дистрибьюторов Европы, Америки и Азии.

С конца 2013 года компания активно расширяет линейку поставок компонентов по направлению коаксиальный кабель, кварцевые генераторы и конденсаторы (керамические, пленочные, электролитические), за счёт заключения дистрибьюторских договоров

Мы предлагаем:

- Конкурентоспособные цены и скидки постоянным клиентам.
- Специальные условия для постоянных клиентов.
- Подбор аналогов.
- Поставку компонентов в любых объемах, удовлетворяющих вашим потребностям.
- Приемлемые сроки поставки, возможна ускоренная поставка.
- Доставку товара в любую точку России и стран СНГ.
- Комплексную поставку.
- Работу по проектам и поставку образцов.
- Формирование склада под заказчика.
- Сертификаты соответствия на поставляемую продукцию (по желанию клиента).
- Тестирование поставляемой продукции.
- Поставку компонентов, требующих военную и космическую приемку.
- Входной контроль качества.
- Наличие сертификата ISO.

В составе нашей компании организован Конструкторский отдел, призванный помогать разработчикам, и инженерам.

Конструкторский отдел помогает осуществить:

- Регистрацию проекта у производителя компонентов.
- Техническую поддержку проекта.
- Защиту от снятия компонента с производства.
- Оценку стоимости проекта по компонентам.
- Изготовление тестовой платы монтаж и пусконаладочные работы.



Тел: +7 (812) 336 43 04 (многоканальный)

Email: [org@lifeelectronics.ru](mailto:org@lifeelectronics.ru)