

MECHANICAL DATA

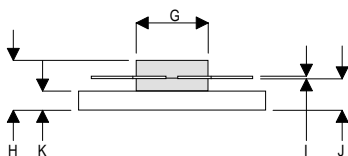
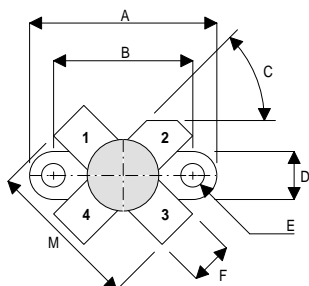

DA

PIN 1 SOURCE PIN 2 DRAIN
 PIN 3 SOURCE PIN 4 GATE

DIM	mm	Tol.	Inches	Tol.
A	24.76	0.13	0.975	0.005
B	18.42	0.13	0.725	0.005
C	45°	5°	45°	5°
D	6.35	0.13	0.25	0.005
E	3.17	0.13	0.125 DIA	0.005
F	5.71	0.13	0.225	0.005
G	9.52	0.13	0.375	0.005
H	6.60	REF	0.260	REF
I	0.13	0.02	0.005	0.001
J	4.32	0.13	0.170	0.005
K	2.54	0.13	0.100	0.005
M	20.32	0.25	0.800	0.010

**GOLD METALLISED
 MULTI-PURPOSE SILICON
 DMOS RF FET
 20W – 28V – 175MHz
 SINGLE ENDED**

FEATURES

- SIMPLIFIED AMPLIFIER DESIGN
- SUITABLE FOR BROAD BAND APPLICATIONS
- LOW C_{rss}
- SIMPLE BIAS CIRCUITS
- LOW NOISE
- HIGH GAIN – 16 dB MINIMUM

APPLICATIONS

- HF/VHF/UHF COMMUNICATIONS
 from 1 MHz to 175 MHz

ABSOLUTE MAXIMUM RATINGS ($T_{case} = 25^{\circ}C$ unless otherwise stated)

P_D	Power Dissipation	50W
BV_{DSS}	Drain – Source Breakdown Voltage	70V
BV_{GSS}	Gate – Source Breakdown Voltage	$\pm 20V$
$I_{D(sat)}$	Drain Current	5A
T_{stg}	Storage Temperature	-65 to $150^{\circ}C$
T_j	Maximum Operating Junction Temperature	$200^{\circ}C$

Semelab Plc reserves the right to change test conditions, parameter limits and package dimensions without notice. Information furnished by Semelab is believed to be both accurate and reliable at the time of going to press. However Semelab assumes no responsibility for any errors or omissions discovered in its use. Semelab encourages customers to verify that datasheets are current before placing orders.

ELECTRICAL CHARACTERISTICS (T_{case} = 25°C unless otherwise stated)

Parameter	Test Conditions	Min.	Typ.	Max.	Unit
B _V DSS Drain–Source Breakdown Voltage	V _{GS} = 0 I _D = 100mA	70			V
I _D DSS Zero Gate Voltage Drain Current	V _{DS} = 28V V _{GS} = 0			1	mA
I _G DSS Gate Leakage Current	V _{GS} = 20V V _{DS} = 0			1	μA
V _{GS(th)} Gate Threshold Voltage*	I _D = 10mA V _{DS} = V _{GS}	1		7	V
g _{fs} Forward Transconductance*	V _{DS} = 10V I _D = 1A	0.8			S
G _{PS} Common Source Power Gain	P _O = 20W	16			dB
η Drain Efficiency	V _{DS} = 28V I _{DQ} = 0.1A	50			%
VSWR Load Mismatch Tolerance	f = 175MHz	20:1			—
C _{iss} Input Capacitance	V _{DS} = 28V V _{GS} = -5V f = 1MHz			60	pF
C _{oss} Output Capacitance	V _{DS} = 28V V _{GS} = 0 f = 1MHz			30	pF
C _{rss} Reverse Transfer Capacitance	V _{DS} = 28V V _{GS} = 0 f = 1MHz			2.5	pF
R _{dson} Saturation Resistance	V _{GS} = 20V I _{DS} = 2.5A		1		Ω

* Pulse Test: Pulse Duration = 300 μs , Duty Cycle ≤ 2%

HAZARDOUS MATERIAL WARNING

The ceramic portion of the device between leads and metal flange is beryllium oxide. Beryllium oxide dust is highly toxic and care must be taken during handling and mounting to avoid damage to this area.

THESE DEVICES MUST NEVER BE THROWN AWAY WITH GENERAL INDUSTRIAL OR DOMESTIC WASTE.

THERMAL DATA

R _{THj-case}	Thermal Resistance Junction – Case	Max. 3.5°C / W
-----------------------	------------------------------------	----------------

Semelab Plc reserves the right to change test conditions, parameter limits and package dimensions without notice. Information furnished by Semelab is believed to be both accurate and reliable at the time of going to press. However Semelab assumes no responsibility for any errors or omissions discovered in its use. Semelab encourages customers to verify that datasheets are current before placing orders.

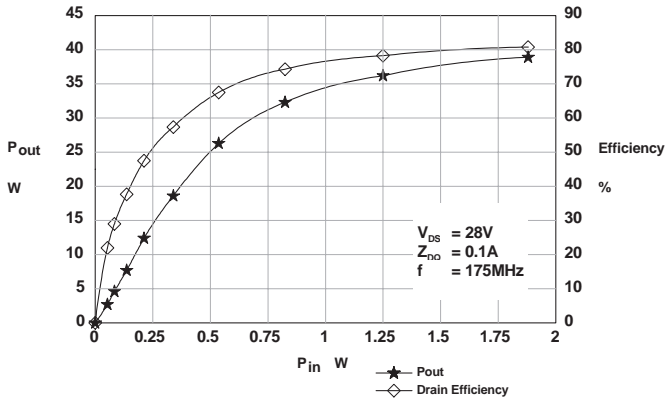

Figure 1 – Power Output and Efficiency vs. Power Input.

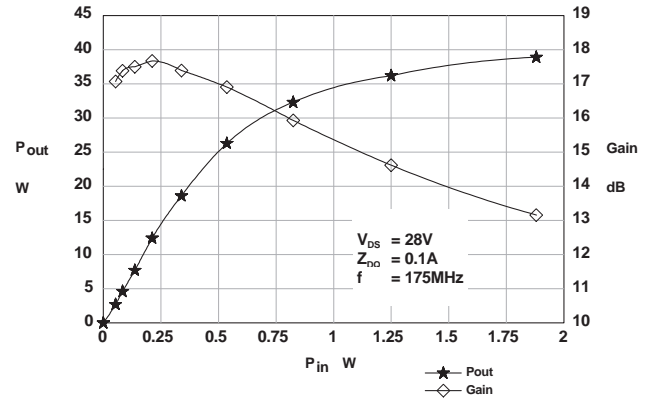

Figure 2 – Power Output & Gain vs. Power Input.

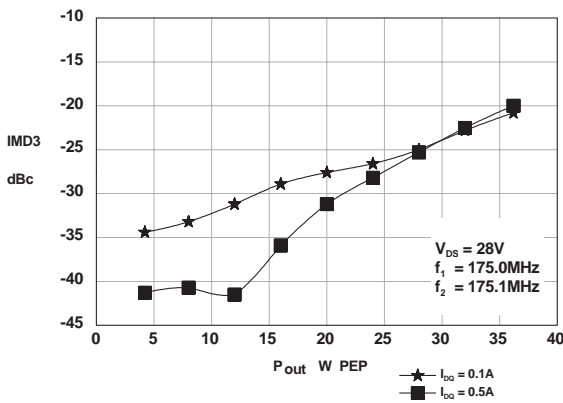

Figure 3 – IMD vs. Output Power.

D1001UK
OPTIMUM SOURCE AND LOAD IMPEDANCE

Frequency MHz	Z _S Ω	Z _L Ω
175MHz	5 + j14	12 - j14

Typical S Parameters

! V_{DS} = 28V, I_{DQ} = 0.1A
MHZ S MA R 50

!Freq MHz	S11		S21		S12		S22	
	mag	ang	mag	ang	mag	ang	mag	ang
50	0.780	-116	18	112	0.034	25	0.642	-85
100	0.775	-135	9.312	85	0.030	11	0.577	-103
150	0.795	-149	6.077	68	0.022	14	0.613	-116
200	0.826	-159	4.193	53	0.017	44	0.669	-128
250	0.853	-169	3.216	43	0.023	74	0.715	-139
300	0.878	-179	2.566	35	0.039	89	0.759	-150
350	0.903	171	1.991	23	0.052	86	0.801	-161
400	0.923	161	1.655	18	0.070	84	0.839	-173
450	0.944	151	1.322	9	0.080	80	0.878	177
500	0.963	142	1.121	4	0.098	76	0.914	167
550	0.978	136	0.899	-2	0.108	72	0.945	159
600	0.985	131	0.762	-7	0.119	66	0.966	153

Semelab Plc reserves the right to change test conditions, parameter limits and package dimensions without notice. Information furnished by Semelab is believed to be both accurate and reliable at the time of going to press. However Semelab assumes no responsibility for any errors or omissions discovered in its use. Semelab encourages customers to verify that datasheets are current before placing orders.

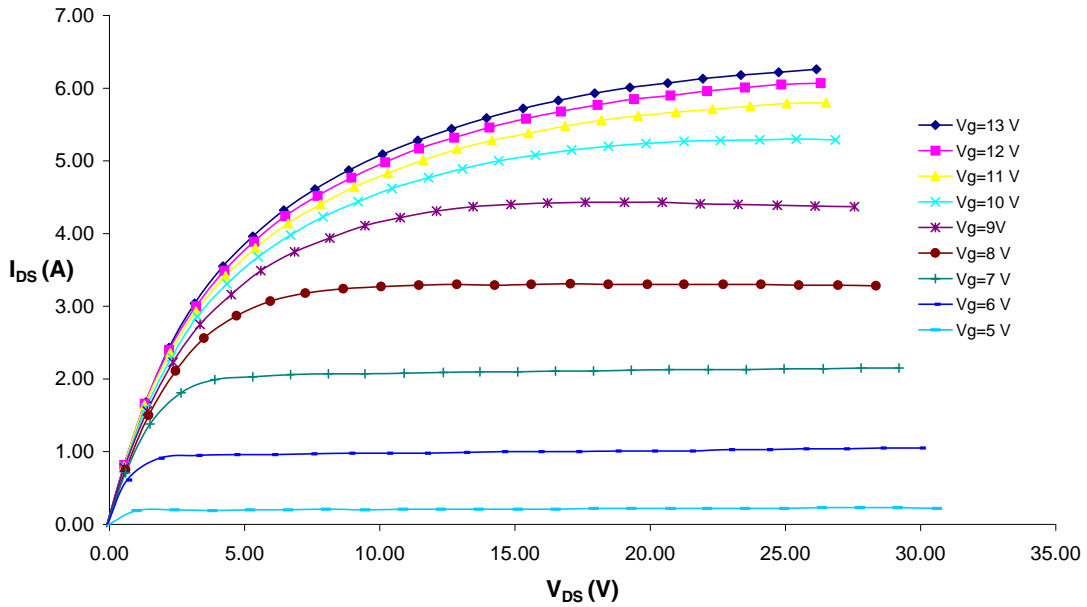

Figure 4 – Typical IV Characteristics.

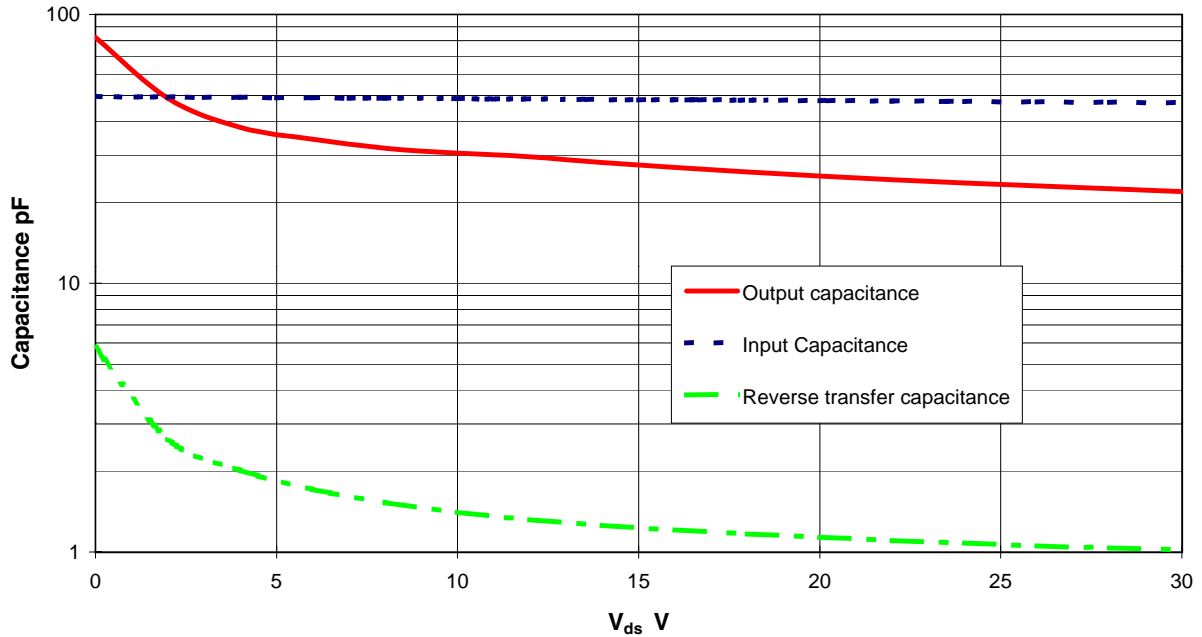
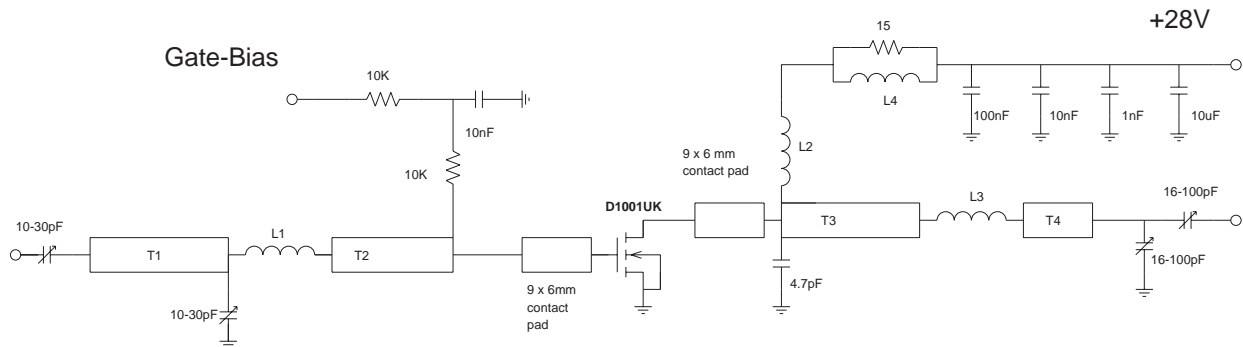

Figure 5 – Typical CV Characteristics.

Semelab Plc reserves the right to change test conditions, parameter limits and package dimensions without notice. Information furnished by Semelab is believed to be both accurate and reliable at the time of going to press. However Semelab assumes no responsibility for any errors or omissions discovered in its use. Semelab encourages customers to verify that datasheets are current before placing orders.



D1001UK 175MHz TEST FIXTURE

Substrate 1.6mm PTFE/glass, Er=2.5
All microstrip lines W=4.4mm

T1 10mm
T2 13mm
T3 12mm
T4 4mm

L1 1.5 turns 22swg enamelled copper wire, 6mm i.d.
L2 10 turns 19swg enamelled copper wire, 6mm i.d.
L3 1.5 turns 22swg enamelled copper wire, 6mm i.d.
L4 13.5 turns 19swg enamelled copper wire on Siemens B64920A618X830 ferrite core

Mouser Electronics

Authorized Distributor

Click to View Pricing, Inventory, Delivery & Lifecycle Information:

[TT Electronics:](#)

[D1001UK](#)

Компания «Life Electronics» занимается поставками электронных компонентов импортного и отечественного производства от производителей и со складов крупных дистрибьюторов Европы, Америки и Азии.

С конца 2013 года компания активно расширяет линейку поставок компонентов по направлению коаксиальный кабель, кварцевые генераторы и конденсаторы (керамические, пленочные, электролитические), за счёт заключения дистрибьюторских договоров

Мы предлагаем:

- Конкурентоспособные цены и скидки постоянным клиентам.
- Специальные условия для постоянных клиентов.
- Подбор аналогов.
- Поставку компонентов в любых объемах, удовлетворяющих вашим потребностям.
- Приемлемые сроки поставки, возможна ускоренная поставка.
- Доставку товара в любую точку России и стран СНГ.
- Комплексную поставку.
- Работу по проектам и поставку образцов.
- Формирование склада под заказчика.
- Сертификаты соответствия на поставляемую продукцию (по желанию клиента).
- Тестирование поставляемой продукции.
- Поставку компонентов, требующих военную и космическую приемку.
- Входной контроль качества.
- Наличие сертификата ISO.

В составе нашей компании организован Конструкторский отдел, призванный помогать разработчикам, и инженерам.

Конструкторский отдел помогает осуществить:

- Регистрацию проекта у производителя компонентов.
- Техническую поддержку проекта.
- Защиту от снятия компонента с производства.
- Оценку стоимости проекта по компонентам.
- Изготовление тестовой платы монтаж и пусконаладочные работы.



Тел: +7 (812) 336 43 04 (многоканальный)
Email: org@lifeelectronics.ru