

# Chip Beads

For signal line

## MMZ series

Type:	MMZ0402	0402[01005 inch]*
	MMZ0603	0603[0201 inch]
	MMZ1005	1005[0402 inch]
	MMZ1608	1608[0603 inch]
	MMZ2012	2012[0805 inch]
	MMZ0603-E	0603[0201 inch]
	MMZ1005-E	1005[0402 inch]

\* Dimensions Code JIS[EIA]

Issue date: March 2013

- All specifications are subject to change without notice.
- Conformity to RoHS Directive: This means that, in conformity with EU Directive 2002/95/EC, lead, cadmium, mercury, hexavalent chromium, and specific bromine-based flame retardants, PBB and PBDE, have not been used, except for exempted applications.

# Chip Beads

## For Signal Line

Conformity to RoHS Directive

### MMZ Series MMZ0402

#### FEATURES

- It is super small size(L0.4×W0.2×T0.2mm).
- It prevents radiated noise from high-speed signal lines.
- Maintain impedance to high frequency band.
- Because it adopts silver in internal electrode, it is low DC resistance.
- Because it is not generate of cross talk with closed magnetic circuit structural design, high density assembly is possible.
- It is a product conforming to RoHS directive.

#### APPLICATIONS

Removal of signal line noises of cellular phones, portable audio players, various modules, etc.

#### PRODUCT IDENTIFICATION

MMZ 0402 S 121 C T   
 (1) (2) (3) (4) (5) (6) (7)

- (1) Series name
- (2) Dimensions L×W
- (3) Type name
- (4) Impedance  
121:120Ω at 100MHz
- (5) Characteristic type
- (6) Packaging style  
T: Taping
- (7) TDK internal code

#### HANDLING AND PRECAUTIONS

- Before soldering, be sure to preheat components. The preheating temperature should be set so that the temperature difference between the solder temperature and product temperature does not exceed 150°C.
- After mounting components onto the printed circuit board, do not apply stress through board bending or mishandling.
- Do not expose the inductors to stray magnetic fields.
- Avoid static electricity discharge during handling.

#### SHAPES AND DIMENSIONS/RECOMMENDED PC BOARD PATTERN

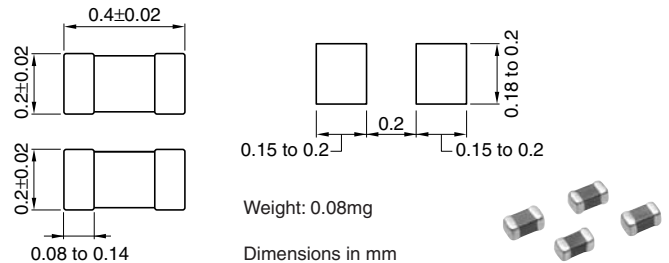

#### SPECIFICATIONS

Operating temperature range	-55 to +125°C
Storage temperature range	-55 to +125°C(After mount)

#### PACKAGING STYLE AND QUANTITIES

Packaging style	Quantity
Taping	20000 pieces/reel

#### RECOMMENDED SOLDERING CONDITION

##### REFLOW SOLDERING

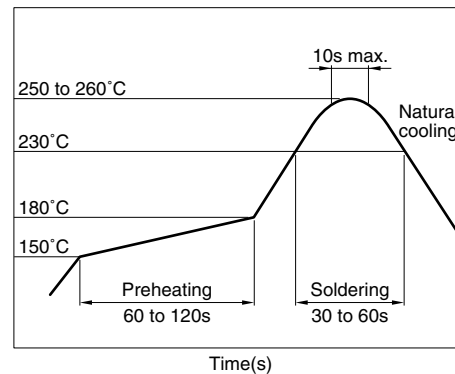

#### ELECTRICAL CHARACTERISTICS

Part No.	Impedance (Ω)[100MHz]*	DC resistance (Ω)max.	Rated current (mA)max.
MMZ0402S100C	10±5Ω	0.10	500
MMZ0402S700C	70±25%	0.45	260
MMZ0402S121C	120±25%	0.70	210
MMZ0402S151C	150±25%	0.70	200

\* Test equipment: E4991A or equivalent  
 Test tool: 16197 or equivalent  
 Test temperature: 25±10°C

• Conformity to RoHS Directive: This means that, in conformity with EU Directive 2002/95/EC, lead, cadmium, mercury, hexavalent chromium, and specific bromine-based flame retardants, PBB and PBDE, have not been used, except for exempted applications.

• Please contact our Sales office when your application is considered the following:  
 The device's failure or malfunction may directly endanger human life (e.g. application for automobile/aircraft/medical/nuclear power devices, etc.)

• All specifications are subject to change without notice.

**TYPICAL ELECTRICAL CHARACTERISTICS**  
**Z FREQUENCY CHARACTERISTICS(DIFFERS ACCORDING TO SERIES)**  
**MMZ0402S SERIES**

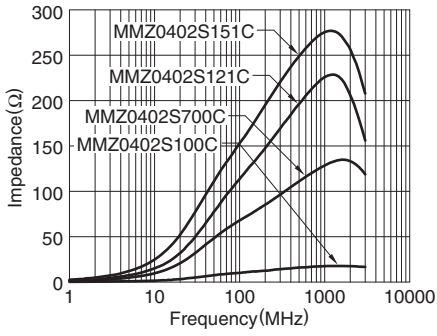

**Z, X, R vs. FREQUENCY CHARACTERISTICS**  
**MMZ0402S100C**

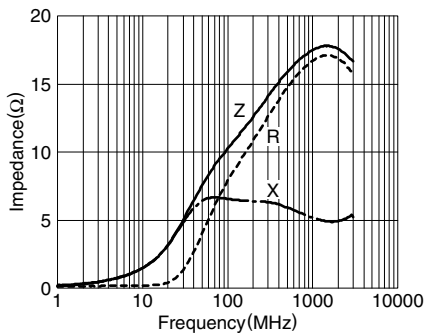

**MMZ0402S700C**

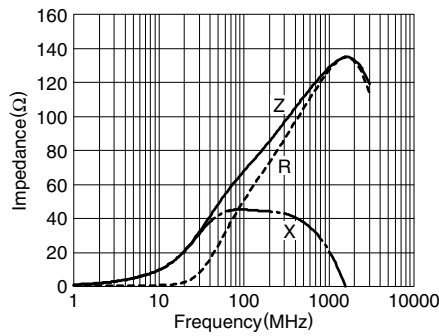

**MMZ0402S121C**

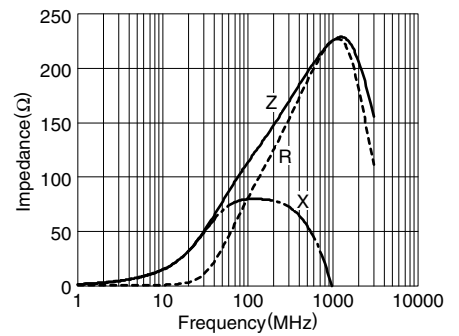

**MMZ0402S151C**

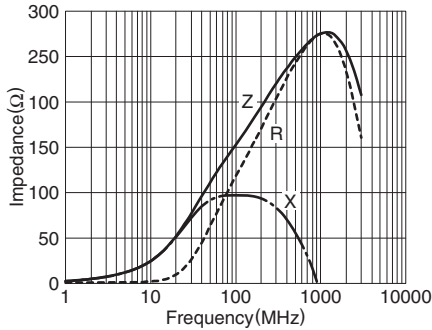

**PACKAGING STYLES**  
**REEL DIMENSIONS**

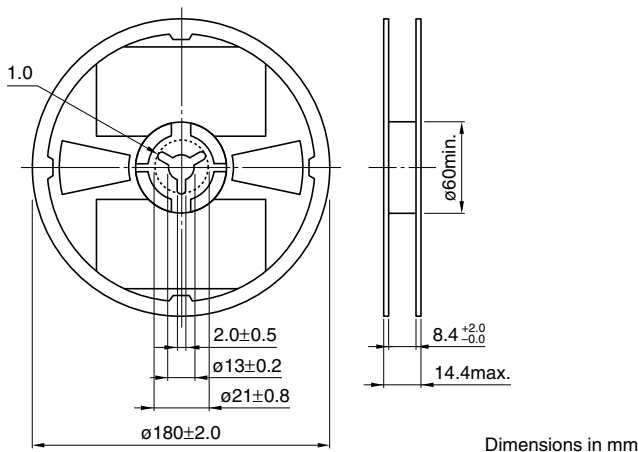

**TAPE DIMENSIONS**

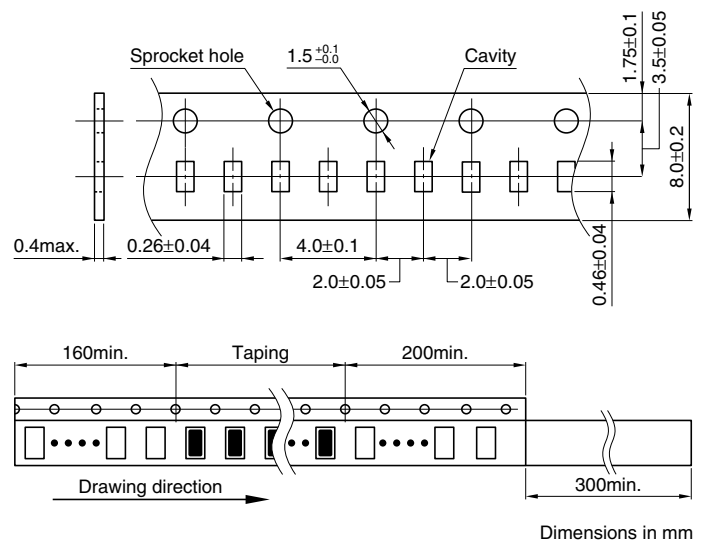

• All specifications are subject to change without notice.

# Chip Beads For Signal Line

Conformity to RoHS Directive

## MMZ Series MMZ0603

### FEATURES

- This is a multilayered chip bead product with dimensions of L0.6×W0.3×T0.3mm.
- The product is magnetically shielded, allowing high density mounting.
- We refined the rules for internal conductor design to reduce floating capacity between conductors, which in turn has contributed to a dramatic improvement in high frequency characteristics. We have also been able to expand and reinforce the EMI suppression in the GHz range.
- It is a product conforming to RoHS directive.

### APPLICATIONS

Removal of signal line noises of cellular phones, portable audio players, various modules, DSCs, portable game machines, etc.

### PRODUCT IDENTIFICATION

MMZ	0603	S	121	C	T	□□□
(1)	(2)	(3)	(4)	(5)	(6)	(7)

- (1) Series name
- (2) Dimensions L×W
- (3) Type name
- (4) Impedance  
121:120Ω at 100MHz
- (5) Characteristic type
- (6) Packaging style  
T:Taping
- (7) TDK internal code

### HANDLING AND PRECAUTIONS

- Before soldering, be sure to preheat components. The preheating temperature should be set so that the temperature difference between the solder temperature and product temperature does not exceed 150°C.
- After mounting components onto the printed circuit board, do not apply stress through board bending or mishandling.
- Do not expose the inductors to stray magnetic fields.
- Avoid static electricity discharge during handling.
- When hand soldering, apply the soldering iron to the printed circuit board only. Temperature of the iron tip should not exceed 350°C. Soldering time should not exceed 3 seconds.

### MATERIAL CHARACTERISTICS

- S material:** Standard type that features impedance characteristics similar to those of a typical ferrite core.  
For signal line applications in which the blocking region is near 100MHz. Impedance values selected for effectiveness at 40 to 300MHz.
- Y material:** High frequency range type intended for the 100MHz region and above.  
For signal line applications in which the signal frequency is far from the cutoff frequency. Impedance values selected for effectiveness at 80 to 400MHz.
- D material:** For applications calling for low insertion loss at low frequencies and sharply increasing impedance at high frequencies. Designed for high impedance at high frequencies (300MHz to 1GHz) for signal line applications.
- F material:** This new product inherits the characteristic of our D-material, namely its sharp impedance rise time, and its impedance peak frequency has been shifted higher into range. The product offers excellent noise suppression from 600MHz to as high as in the GHz range.

### TYPICAL MATERIAL CHARACTERISTICS

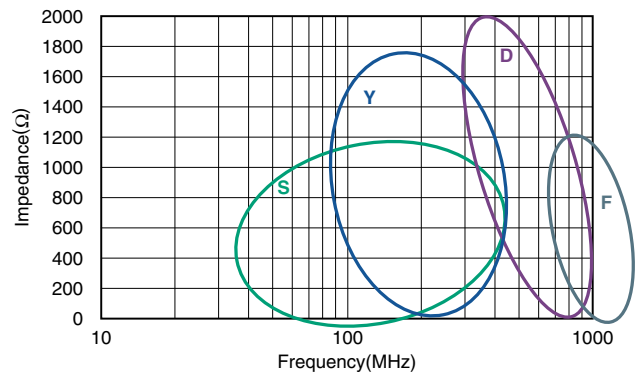

• Conformity to RoHS Directive: This means that, in conformity with EU Directive 2002/95/EC, lead, cadmium, mercury, hexavalent chromium, and specific bromine-based flame retardants, PBB and PBDE, have not been used, except for exempted applications.

• Please contact our Sales office when your application is considered the following:  
The device's failure or malfunction may directly endanger human life (e.g. application for automobile/aircraft/medical/nuclear power devices, etc.)

• All specifications are subject to change without notice.

## SHAPES AND DIMENSIONS/RECOMMENDED PC BOARD PATTERN

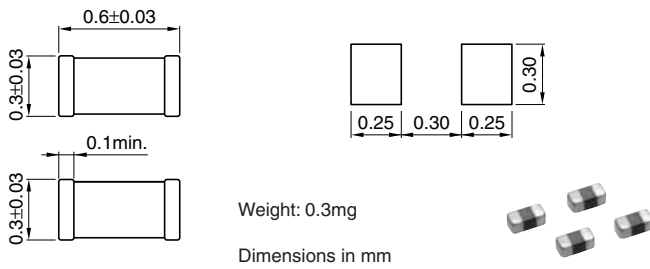

## SPECIFICATIONS

Operating temperature range	-55 to +125°C
Storage temperature range	-55 to +125°C(After mount)

## PACKAGING STYLE AND QUANTITIES

Packaging style	Quantity
Taping	15000 pieces/reel

## RECOMMENDED SOLDERING CONDITION REFLOW SOLDERING

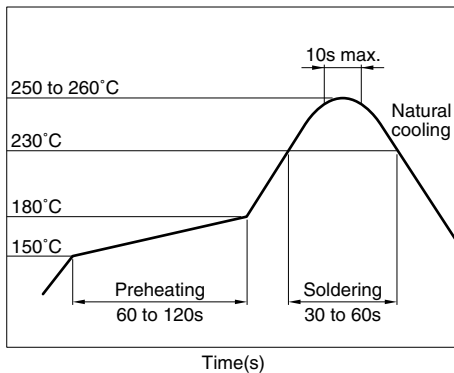

## ELECTRICAL CHARACTERISTICS

Part No.	Impedance (Ω)[100MHz]*	DC resistance (Ω)max.	Rated current (mA)max.
MMZ0603S100C	10±5%	0.09	500
MMZ0603S800C	80±25%	0.30	200
MMZ0603S121C	120±25%	0.45	200
MMZ0603S241C	240±25%	0.57	200
MMZ0603S471C	470±25%	1.30	100
MMZ0603S601C	600±25%	1.45	100
MMZ0603S102H	1000±25%	1.25	200
MMZ0603Y750C	75±25%	0.35	300
MMZ0603Y121C	120±25%	0.39	200
MMZ0603Y241C	240±25%	0.80	200
MMZ0603Y471C	470±25%	1.40	200
MMZ0603Y601C	600±25%	1.50	200
MMZ0603D330C	33±25%	0.70	200
MMZ0603D470C	47±25%	0.70	200
MMZ0603D560C	56±25%	0.95	100
MMZ0603D800C	80±25%	1.25	100
MMZ0603D121C	120±25%	1.40	100
MMZ0603F100C	10±5%	0.50	200
MMZ0603F220C	22±25%	1.00	200
MMZ0603F330C	33±25%	1.30	150

\* Test equipment: E4991A or equivalent  
Test tool: 16197 or equivalent  
Test temperature: 25±10°C

## TYPICAL ELECTRICAL CHARACTERISTICS

### Z FREQUENCY CHARACTERISTICS(DIFFERS ACCORDING TO SERIES)

#### MMZ0603S SERIES

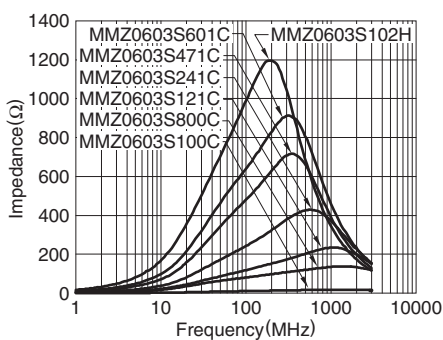

#### MMZ0603Y SERIES

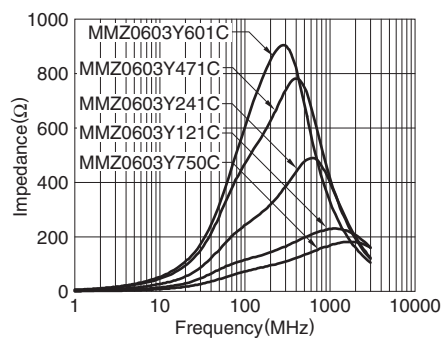

#### MMZ0603D SERIES

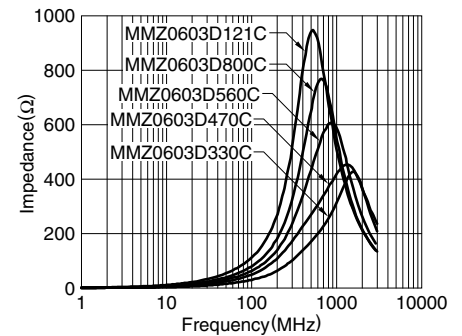

#### MMZ0603F SERIES

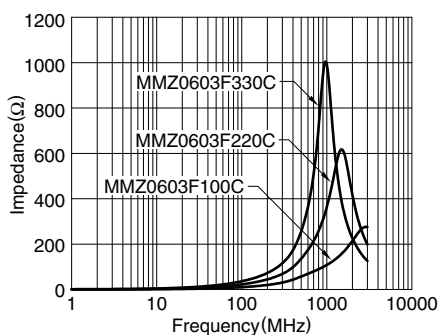

• All specifications are subject to change without notice.

**TYPICAL ELECTRICAL CHARACTERISTICS**

**Z, X, R vs. FREQUENCY CHARACTERISTICS**

**MMZ0603S100C**

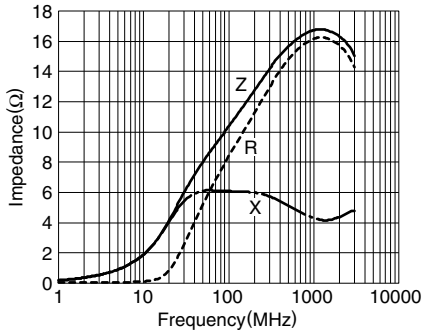

**MMZ0603S800C**

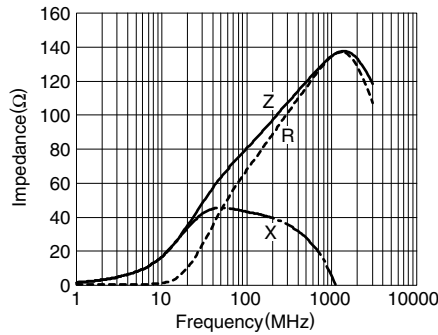

**MMZ0603S121C**

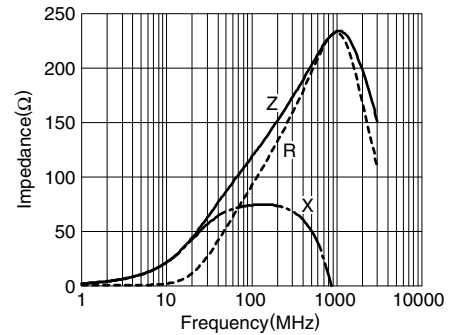

**MMZ0603S241C**

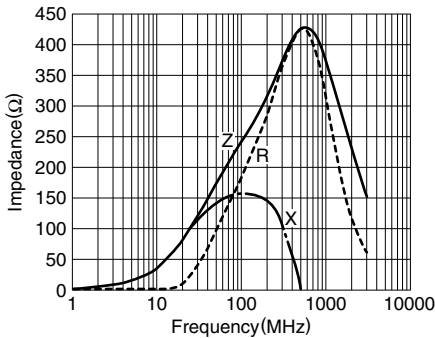

**MMZ0603S471C**

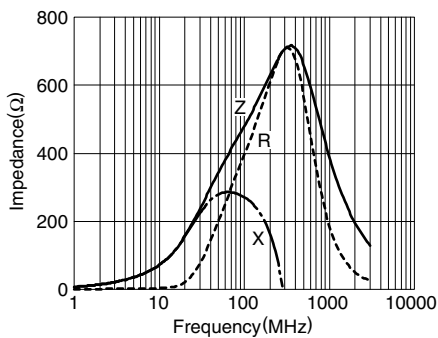

**MMZ0603S601C**

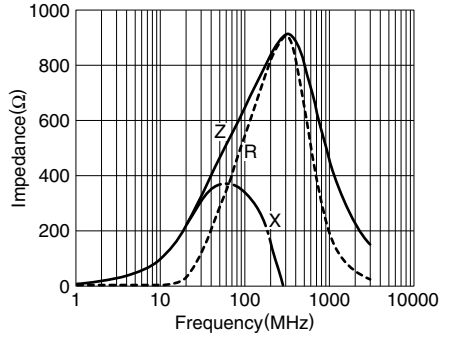

**MMZ0603S102H**

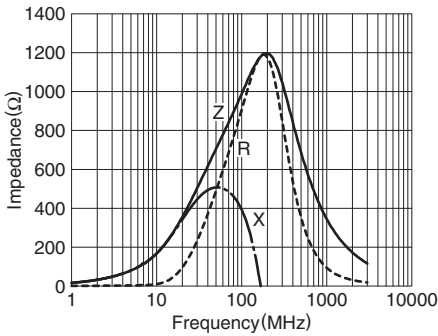

**MMZ0603Y750C**

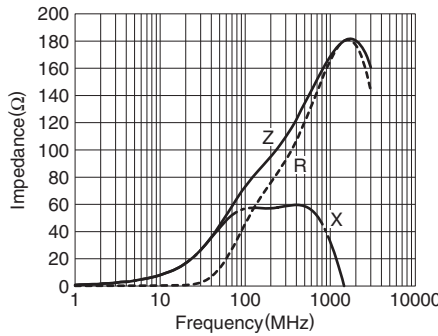

**MMZ0603Y121C**

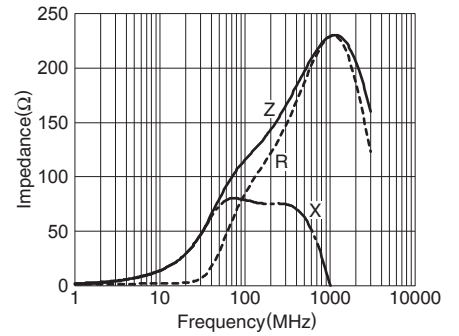

**MMZ0603Y241C**

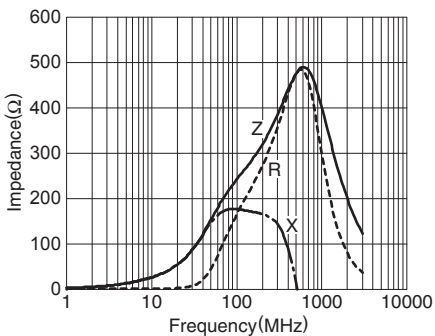

**MMZ0603Y471C**

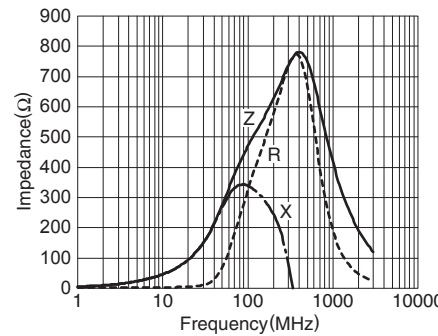

**MMZ0603Y601C**

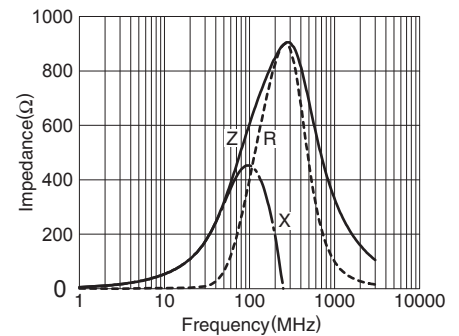

• All specifications are subject to change without notice.

**TYPICAL ELECTRICAL CHARACTERISTICS**  
**Z, X, R vs. FREQUENCY CHARACTERISTICS**  
**MMZ0603D330C**

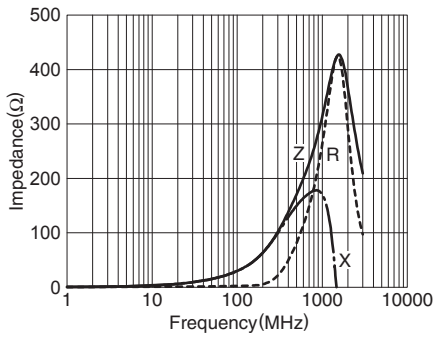

**MMZ0603D470C**

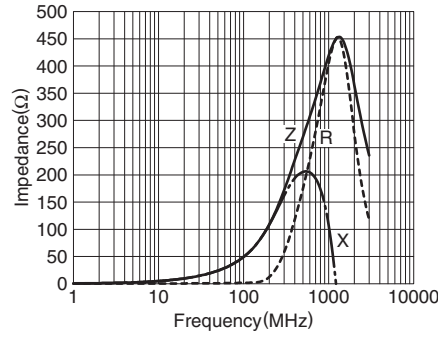

**MMZ0603D560C**

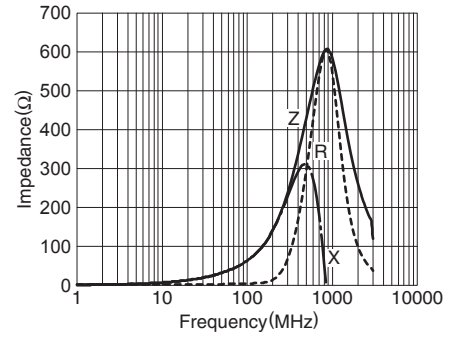

**MMZ0603D800C**

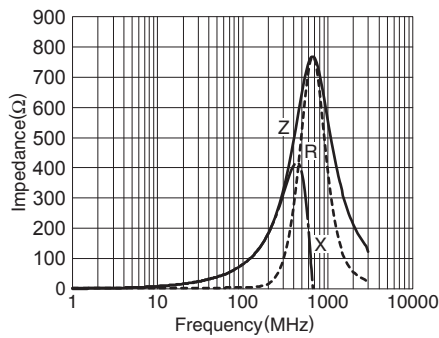

**MMZ0603D121C**

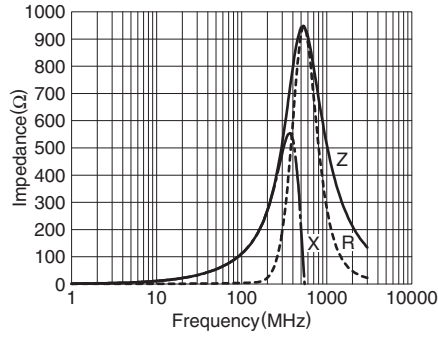

**MMZ0603F100C**

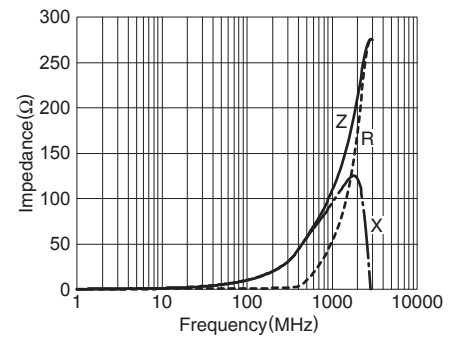

**MMZ0603F220C**

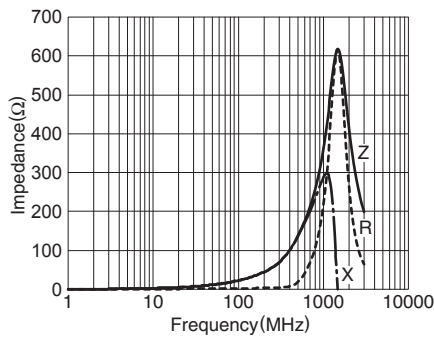

**MMZ0603F330C**

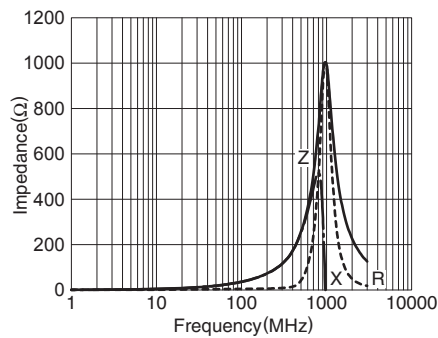

**PACKAGING STYLES**  
**REEL DIMENSIONS**

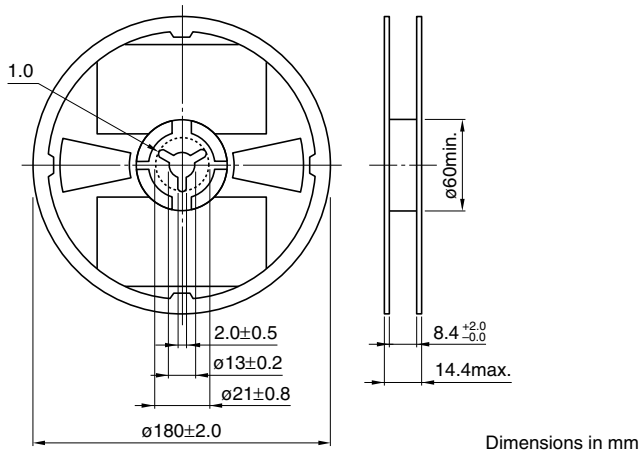

**TAPE DIMENSIONS**

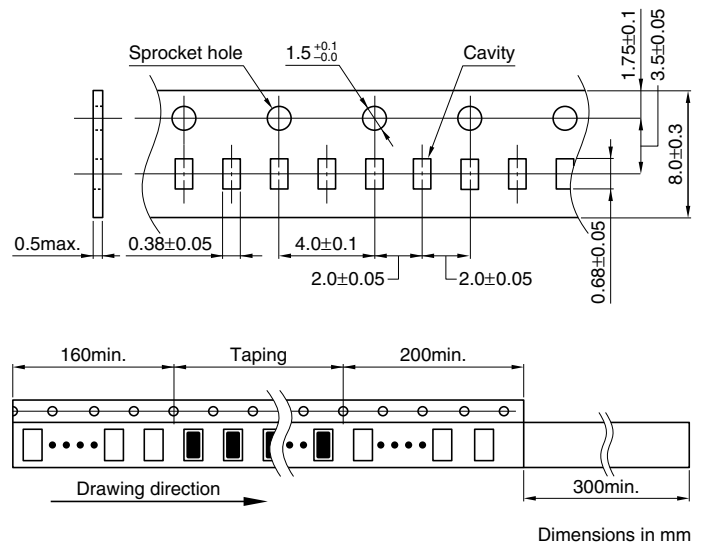

• All specifications are subject to change without notice.

# Chip Beads For Signal Line

Conformity to RoHS Directive

## MMZ Series MMZ1005

### FEATURES

- Size standardized for use by automatic assembly equipment. No preferred orientation.
- Electroplated terminal electrodes accommodate reflow soldering.
- High reliability due to an entirely monolithic structure.
- Closed magnetic circuit structure allows high-density installation while preventing crosstalk between circuits.
- Low DC resistance structure of electrode prevents wasteful electric power consumption.
- It is a product conforming to RoHS directive.

### APPLICATIONS

Removal of signal line noises of cellular phones, PCs, note PCs, TVs, TV tuners, STBs, audio players, DVDs, DSCs, DVCs, game machines, digital photo frames, car navigation system, PNDs, etc.

### PRODUCT IDENTIFICATION

MMZ 1005 S 121 C T □□□  
(1) (2) (3) (4) (5) (6) (7)

- (1) Series name  
 (2) Dimensions L×W  
 (3) Type name  
 (4) Impedance  
 121:120Ω at 100MHz  
 (5) Characteristic type  
 (6) Packaging style  
 T:Taping  
 (7) TDK internal code

### HANDLING AND PRECAUTIONS

- Before soldering, be sure to preheat components. The preheating temperature should be set so that the temperature difference between the solder temperature and product temperature does not exceed 150°C.
- After mounting components onto the printed circuit board, do not apply stress through board bending or mishandling.
- Do not expose the inductors to stray magnetic fields.
- Avoid static electricity discharge during handling.
- When hand soldering, apply the soldering iron to the printed circuit board only. Temperature of the iron tip should not exceed 350°C. Soldering time should not exceed 3 seconds.

### MATERIAL CHARACTERISTICS

**B material:** This type is perfectly suited for fast digital signals. By equalizing R components and X components that beads possess at a frequency of 5MHz, it is able to suppress overshooting, undershooting and ringing of fast digital signals.

**S material:** Standard type that features impedance characteristics similar to those of a typical ferrite core. For signal line applications in which the blocking region is near 100MHz. Impedance values selected for effectiveness at 40 to 300MHz.

**Y material:** High frequency range type intended for the 100MHz region and above. For signal line applications in which the signal frequency is far from the cutoff frequency. Impedance values selected for effectiveness at 80 to 400MHz.

**D material:** For applications calling for low insertion loss at low frequencies and sharply increasing impedance at high frequencies. Designed for high impedance at high frequencies (300MHz to 1GHz) for signal line applications.

**F material:** This new product inherits the characteristic of our D-material, namely its sharp impedance rise time, and its impedance peak frequency has been shifted higher into range. The product offers excellent noise suppression from 600MHz to as high as in the GHz range.

### TYPICAL MATERIAL CHARACTERISTICS

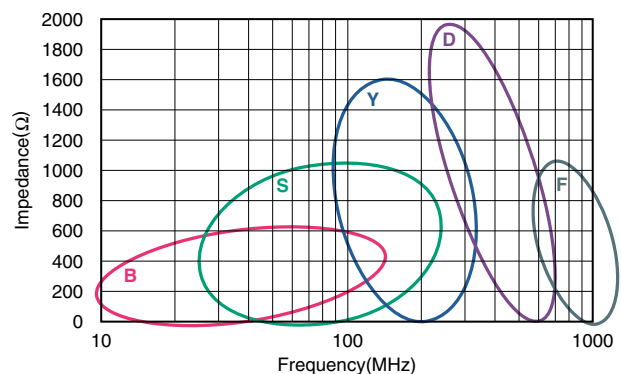

• Conformity to RoHS Directive: This means that, in conformity with EU Directive 2002/95/EC, lead, cadmium, mercury, hexavalent chromium, and specific bromine-based flame retardants, PBB and PBDE, have not been used, except for exempted applications.

• Please contact our Sales office when your application is considered the following:  
 The device's failure or malfunction may directly endanger human life (e.g. application for automobile/aircraft/medical/nuclear power devices, etc.)

• All specifications are subject to change without notice.



**SHAPES AND DIMENSIONS/RECOMMENDED PC BOARD**

**PATTERN**

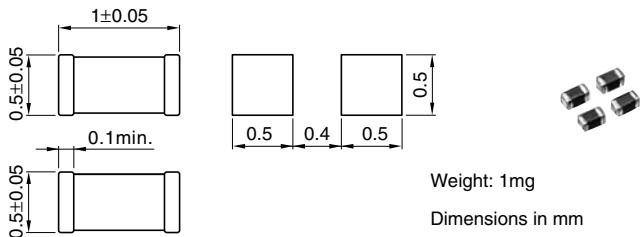

**SPECIFICATIONS**

Operating temperature range	-55 to +125°C
Storage temperature range	-55 to +125°C(After mount)

**PACKAGING STYLE AND QUANTITIES**

Packaging style	Quantity
Taping	10000 pieces/reel

**RECOMMENDED SOLDERING CONDITION**

**REFLOW SOLDERING**

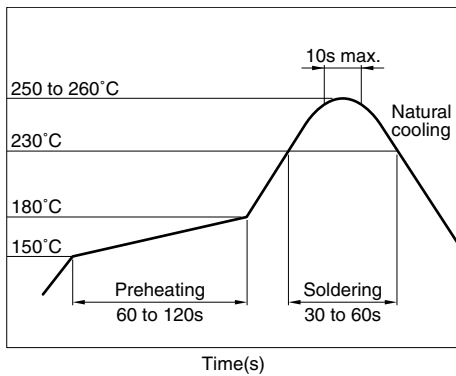

**ELECTRICAL CHARACTERISTICS**

Part No.	Impedance (Ω)[100MHz]*	DC resistance (Ω)max.	Rated current (mA)max.
MMZ1005B800C	80±25%	0.19	450
MMZ1005B121C	120±25%	0.25	400
MMZ1005B601C	600±25%	0.85	200
MMZ1005S800C	80±25%	0.12	500
MMZ1005S121C	120±25%	0.22	500
MMZ1005S241C	240±25%	0.28	400
MMZ1005S601C	600±25%	0.52	300
MMZ1005S102C	1000±25%	0.75	200
MMZ1005Y400C	40±25%	0.10	550
MMZ1005Y800C	80±25%	0.17	450
MMZ1005Y121C	120±25%	0.18	400
MMZ1005Y241C	240±25%	0.26	300
MMZ1005Y301C	300±25%	0.38	250
MMZ1005Y471C	470±25%	0.47	250
MMZ1005Y601C	600±25%	0.54	250
MMZ1005Y102C	1000±25%	0.70	200
MMZ1005Y152C	1500±25%	1.00	100
MMZ1005D100C	10±5Ω	0.10	500
MMZ1005D220C	22±25%	0.17	400
MMZ1005D330C	33±25%	0.24	400
MMZ1005D680C	68±25%	0.38	400
MMZ1005D121C	120±25%	0.60	350
MMZ1005D241C	240±25%	0.90	200
MMZ1005F330C	33±25%	0.50	200
MMZ1005F470C	47±25%	0.60	100
MMZ1005F560C	56±25%	0.70	100

\* Test equipment: E4991A or equivalent  
Test tool: 16192A or equivalent  
Test temperature: 25±10°C

**TYPICAL ELECTRICAL CHARACTERISTICS**

**Z FREQUENCY CHARACTERISTICS(DIFFERS ACCORDING TO SERIES)**

**MMZ1005B SERIES**

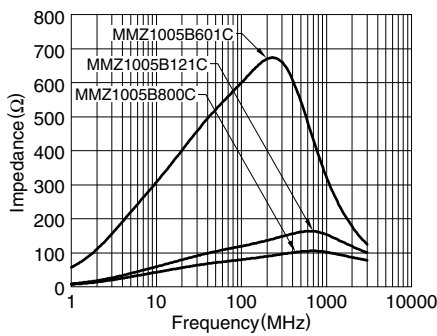

**MMZ1005S SERIES**

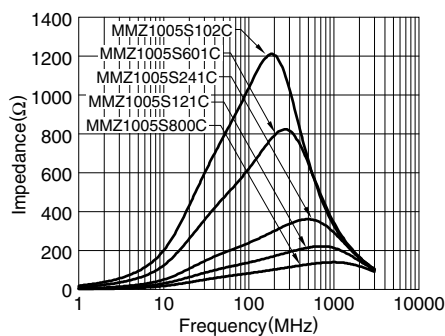

**MMZ1005Y SERIES**

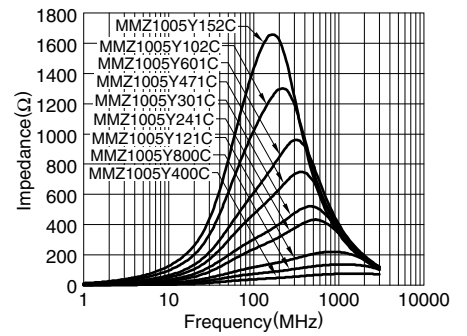

**MMZ1005D SERIES**

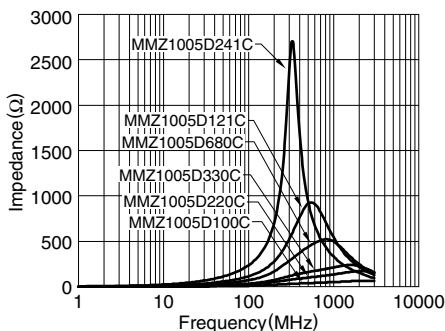

**MMZ1005F SERIES**

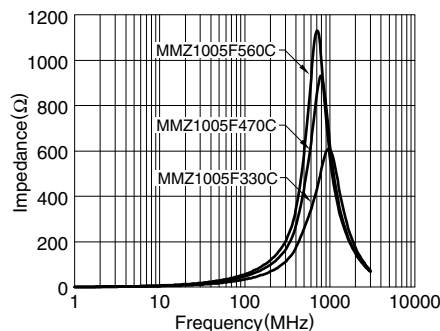

• All specifications are subject to change without notice.

### TYPICAL ELECTRICAL CHARACTERISTICS

#### Z, X, R vs. FREQUENCY CHARACTERISTICS

**MMZ1005B800C**

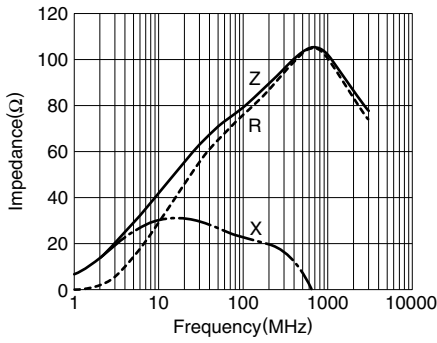

**MMZ1005B121C**

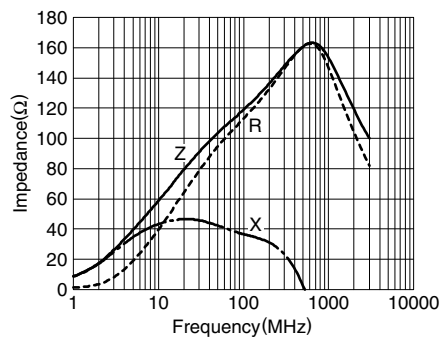

**MMZ1005B601C**

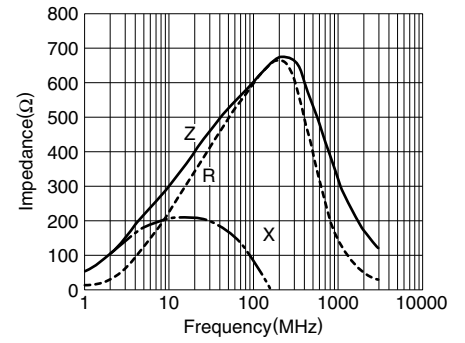

**MMZ1005S800C**

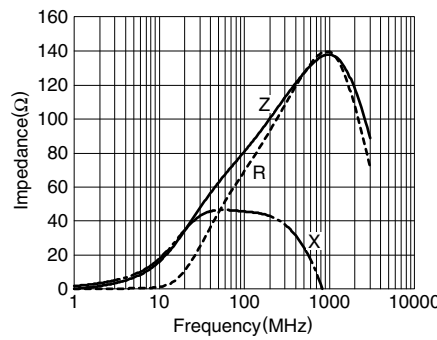

**MMZ1005S121C**

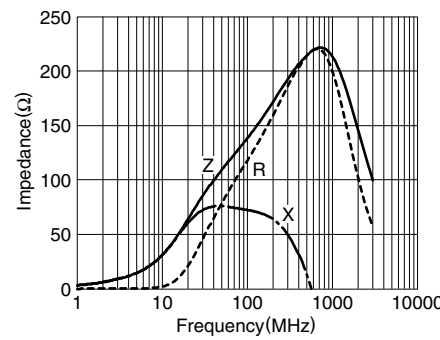

**MMZ1005S241C**

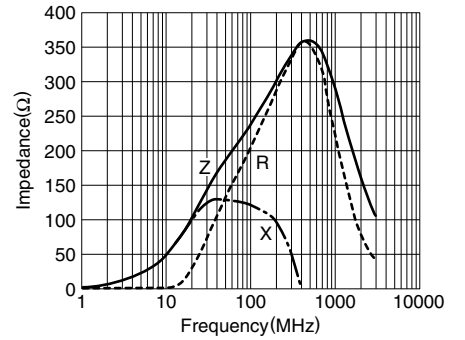

**MMZ1005S601C**

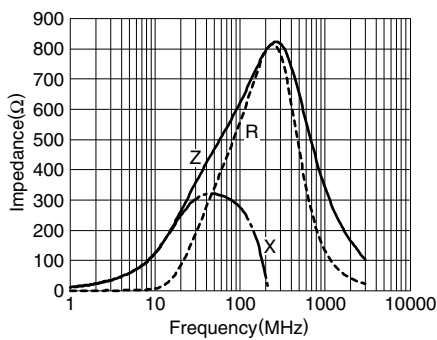

**MMZ1005S102C**

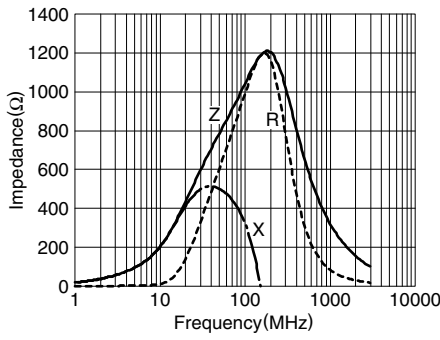

**MMZ1005Y400C**

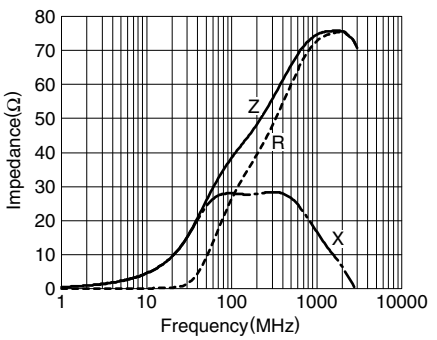

**MMZ1005Y800C**

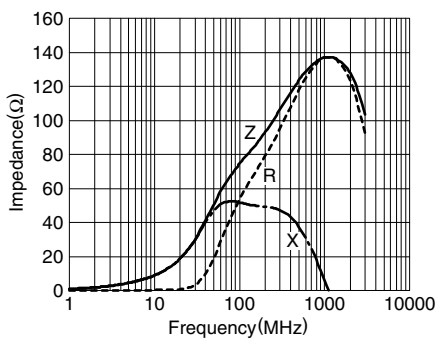

**MMZ1005Y121C**

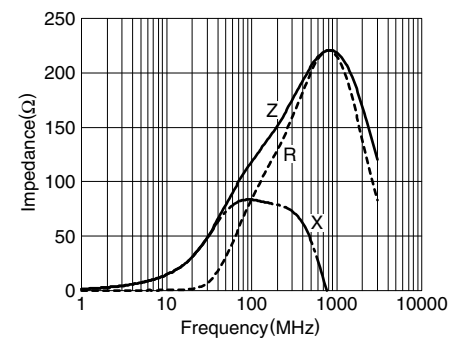

• All specifications are subject to change without notice.

### TYPICAL ELECTRICAL CHARACTERISTICS Z, X, R vs. FREQUENCY CHARACTERISTICS

**MMZ1005Y241C**

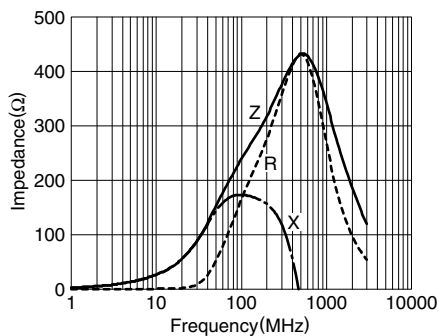

**MMZ1005Y301C**

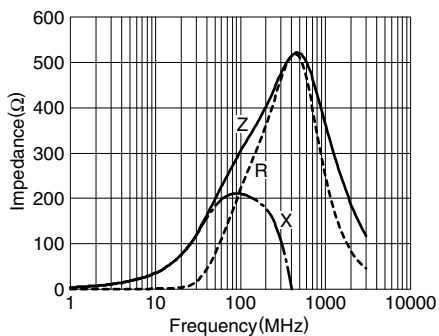

**MMZ1005Y471C**

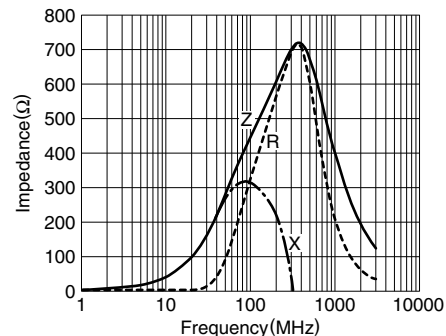

**MMZ1005Y601C**

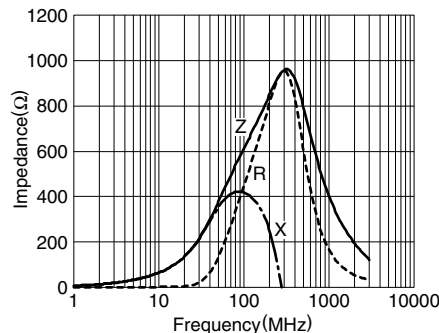

**MMZ1005Y102C**

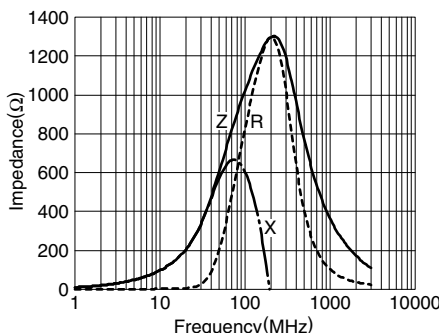

**MMZ1005Y152C**

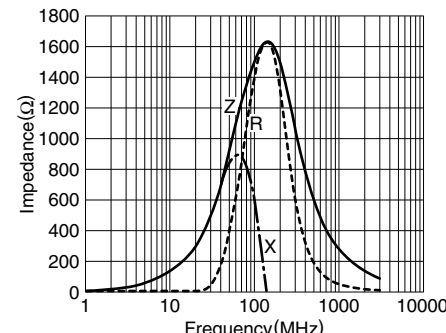

**MMZ1005D100C**

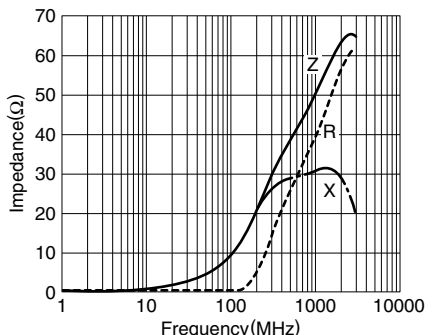

**MMZ1005D220C**

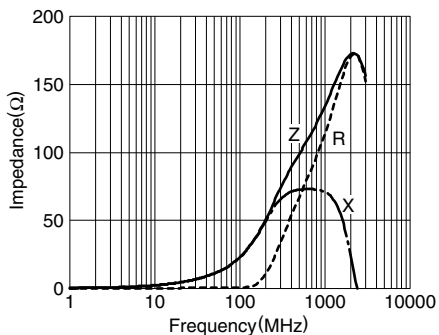

**MMZ1005D330C**

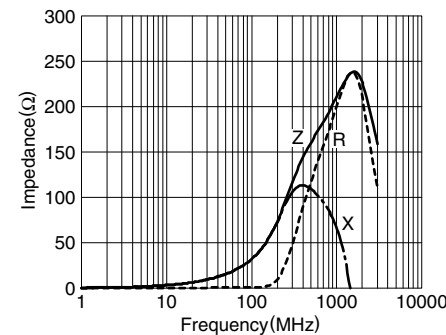

**MMZ1005D680C**

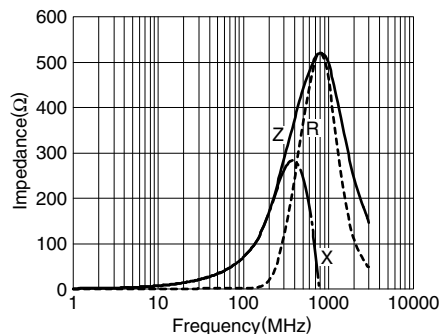

**MMZ1005D121C**

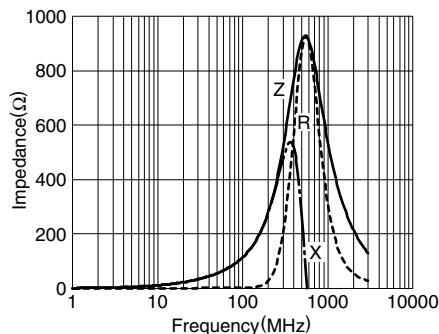

**MMZ1005D241C**

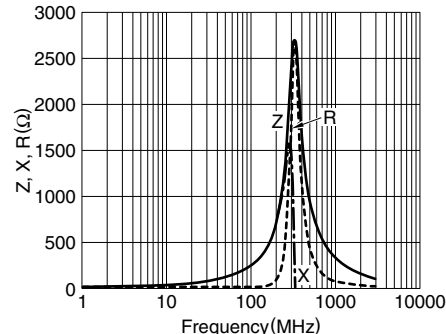

• All specifications are subject to change without notice.

**TYPICAL ELECTRICAL CHARACTERISTICS**

**Z, X, R vs. FREQUENCY CHARACTERISTICS**

**MMZ1005F330C**

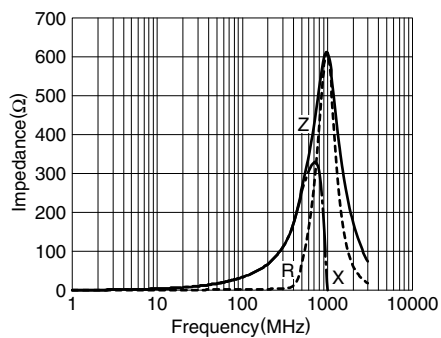

**MMZ1005F470C**

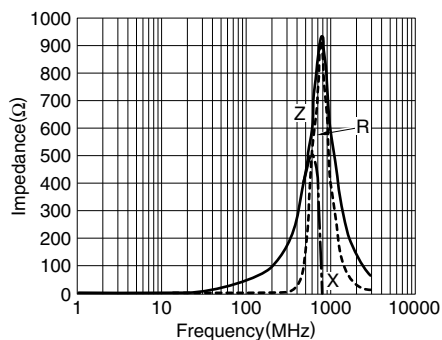

**MMZ1005F560C**

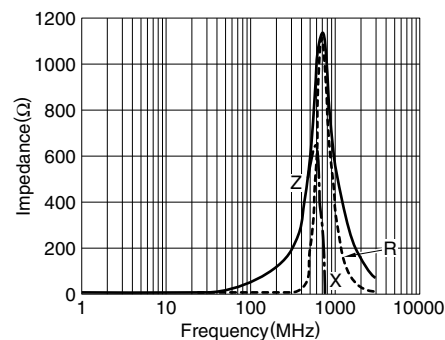

**PACKAGING STYLES**

**REEL DIMENSIONS**

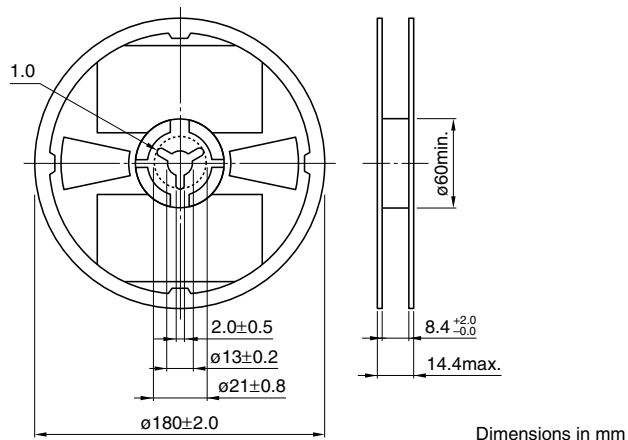

Dimensions in mm

**TAPE DIMENSIONS**

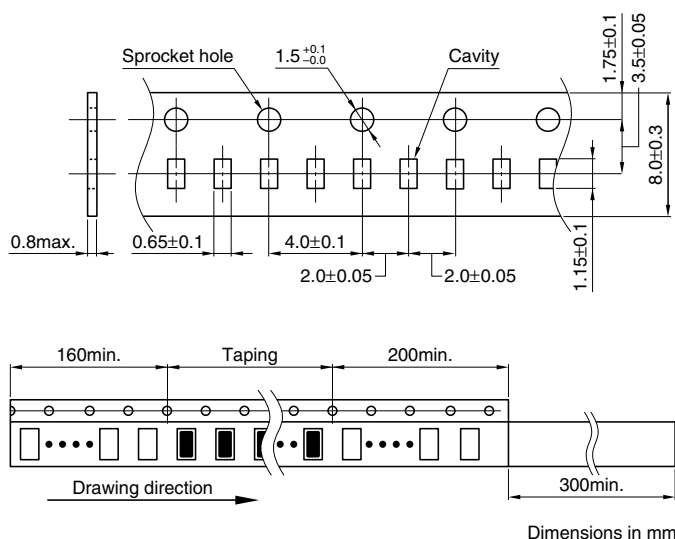

Dimensions in mm

• All specifications are subject to change without notice.

# Chip Beads For Signal Line

Conformity to RoHS Directive

## MMZ Series MMZ1608

### FEATURES

- Chip bead(impeder), MMZ series offers 8 construction materials.
- Size standardized for use by automatic assembly equipment.  
No preferred orientation.
- Either flow or reflow soldering methods can be used due to electroplating of the terminal electrodes.
- High reliability due to an entirely monolithic structure.
- Closed magnetic circuit structure allows high-density installation while preventing crosstalk between circuits.
- Low DC resistance structure of electrode prevents wasteful electric power consumption.
- The products contain no lead and also support lead-free soldering.
- It is a product conforming to RoHS directive.

### APPLICATIONS

Removal of signal line noises of cellular phones, PCs, note PCs, TVs, TV tuners, STBs, audio players, DVDs, DSCs, DVCs, game machines, digital photo frames, car navigation system, PNDs, etc.

### PRODUCT IDENTIFICATION

MMZ 1608 R 121 A T   
 (1) (2) (3) (4) (5) (6) (7)

- (1) Series name
- (2) Dimensions L×W
- (3) Type name
- (4) Impedance  
121:120Ω at 100MHz
- (5) Characteristic type
- (6) Packaging style  
T:Taping
- (7) TDK internal code

### HANDLING AND PRECAUTIONS

- Before soldering, be sure to preheat components. The preheating temperature should be set so that the temperature difference between the solder temperature and product temperature does not exceed 150°C.
- After mounting components onto the printed circuit board, do not apply stress through board bending or mishandling.
- Do not expose the inductors to stray magnetic fields.
- Avoid static electricity discharge during handling.
- When hand soldering, apply the soldering iron to the printed circuit board only. Temperature of the iron tip should not exceed 350°C. Soldering time should not exceed 3 seconds.

• Conformity to RoHS Directive: This means that, in conformity with EU Directive 2002/95/EC, lead, cadmium, mercury, hexavalent chromium, and specific bromine-based flame retardants, PBB and PBDE, have not been used, except for exempted applications.

• Please contact our Sales office when your application is considered the following:  
The device's failure or malfunction may directly endanger human life (e.g. application for automobile/aircraft/medical/nuclear power devices, etc.)

• All specifications are subject to change without notice.

### SHAPES AND DIMENSIONS/RECOMMENDED PC BOARD PATTERN

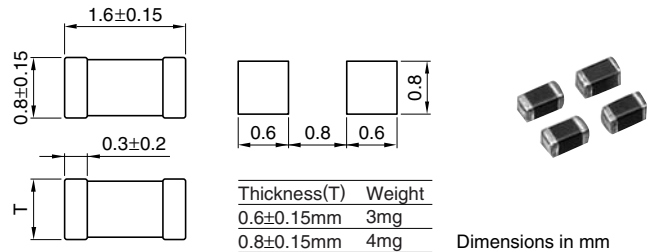

### SPECIFICATIONS

Operating temperature range	-55 to +125°C
Storage temperature range	-55 to +125°C(After mount)

### PACKAGING STYLE AND QUANTITIES

Packaging style	Quantity
Taping	4000 pieces/reel

### RECOMMENDED SOLDERING CONDITION REFLOW SOLDERING

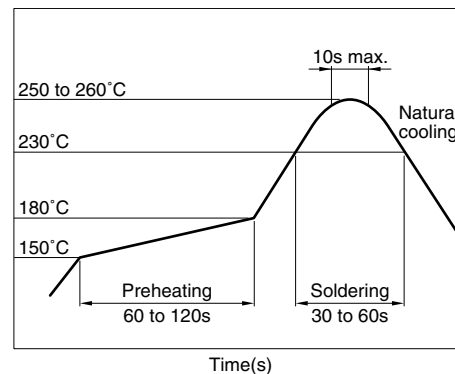

## MATERIAL CHARACTERISTICS

**B material:** This type is perfectly suited for fast digital signals.

By equalizing R components and X components that beads possess at a frequency of 5MHz, it is able to suppress overshooting, undershooting and ringing of fast digital signals.

**R material:** For wide frequency applications calling for broad impedance characteristics.

For digital signal line applications calling requiring good waveform integrity. Impedance values selected for effectiveness at 10 to 200MHz.

**S material:** Standard type that features impedance characteristics similar to those of a typical ferrite core.

For signal line applications in which the blocking region is near 100MHz. Impedance values selected for effectiveness at 40 to 300MHz.

**Y material:** High frequency range type intended for the 100MHz region and above.

For signal line applications in which the signal frequency is far from the cutoff frequency. Impedance values selected for effectiveness at 80 to 400MHz.

**A material:** This high-impedance product is based on the impedance frequency characteristics of our Y-material.

The product offers excellent impedance characteristics, which is greater than 2500Ω, in the vicinity of 100MHz range (MMZ1608A252B).

**Q material:** For high-band applications designed for 100MHz and above. Impedance values selected for effectiveness at 100 to 800MHz.

**D material:** For applications calling for low insertion loss at low frequencies and sharply increasing impedance at high frequencies. Designed for high impedance at high frequencies (300MHz to 1GHz) for signal line applications.

**F material:** This new product inherits the characteristic of our D-material, namely its sharp impedance rise time, and its impedance peak frequency has been shifted higher into range.

The product offers excellent noise suppression from 600MHz to as high as in the GHz range.

## TYPICAL MATERIAL CHARACTERISTICS

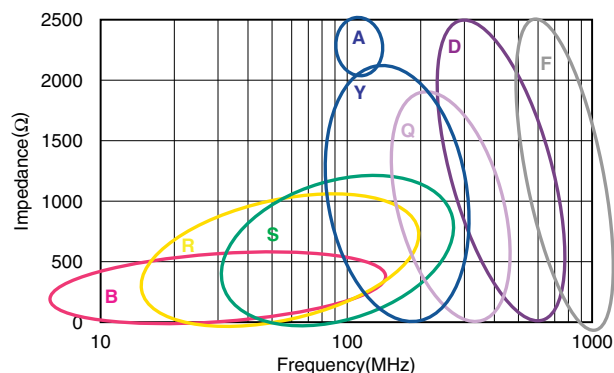

## ELECTRICAL CHARACTERISTICS

Part No.	Impedance (Ω) [100MHz]*	DC resistance (Ω)max.	Rated current (mA)max.	Product's thickness T(mm)
MMZ1608B121C	120±25%	0.15	600	0.6
MMZ1608B221C	220±25%	0.25	500	0.6
MMZ1608B301C	300±25%	0.25	500	0.6
MMZ1608B471C	470±25%	0.30	500	0.6
MMZ1608B601C	600±25%	0.40	500	0.6
MMZ1608B102C	1000±25%	0.60	300	0.8
MMZ1608R150A	15±25%	0.05	1500	0.8
MMZ1608R300A	30±25%	0.05	1500	0.8
MMZ1608R600A	60±25%	0.10	800	0.8
MMZ1608R121A	120±25%	0.18	500	0.8
MMZ1608R301A	300±25%	0.25	500	0.8
MMZ1608R471A	470±25%	0.30	500	0.8
MMZ1608R601A	600±25%	0.40	500	0.8
MMZ1608R102A	1000±25%	0.50	400	0.8
MMZ1608S400A	40±25%	0.10	600	0.8
MMZ1608S800A	80±25%	0.15	500	0.8
MMZ1608S121A	120±25%	0.15	500	0.8
MMZ1608S181A	180±25%	0.20	500	0.8
MMZ1608S221A	220±25%	0.20	500	0.8
MMZ1608S301A	300±25%	0.30	500	0.8
MMZ1608S471A	470±25%	0.30	500	0.8
MMZ1608S601A	600±25%	0.35	500	0.8
MMZ1608S102A	1000±25%	0.50	400	0.8
MMZ1608S202A	2000±25%	0.90	200	0.8
MMZ1608Y150B	15±25%	0.05	1500	0.8
MMZ1608Y300B	30±25%	0.05	1500	0.8
MMZ1608Y600B	60±25%	0.15	500	0.8
MMZ1608Y121B	120±25%	0.20	500	0.8
MMZ1608Y221B	220±25%	0.30	500	0.8
MMZ1608Y301B	300±25%	0.30	500	0.8
MMZ1608Y471B	470±25%	0.35	500	0.8
MMZ1608Y601B	600±25%	0.40	500	0.8
MMZ1608Y751B	750±25%	0.45	500	0.8
MMZ1608Y102B	1000±25%	0.50	400	0.8
MMZ1608Y152B	1500±25%	0.60	300	0.8
MMZ1608A182B	1800±25%	0.80	200	0.8
MMZ1608A222B	2200±25%	0.80	200	0.8
MMZ1608A252B	2500±25%	0.80	200	0.8
MMZ1608Q121B	120±25%	0.30	500	0.8
MMZ1608Q221B	220±25%	0.40	500	0.8
MMZ1608Q331B	330±25%	0.50	400	0.8
MMZ1608Q471B	470±25%	0.70	300	0.8
MMZ1608Q601B	600±25%	0.80	200	0.8
MMZ1608Q102B	1000±25%	1.00	200	0.8
MMZ1608D050C	5±2Ω	0.05	700	0.8
MMZ1608D100C	10±5Ω	0.10	500	0.6
MMZ1608D220C	22±25%	0.20	500	0.6
MMZ1608D500C	50±25%	0.25	500	0.6
MMZ1608D800C	80±25%	0.30	500	0.6
MMZ1608D800B	80±25%	0.30	500	0.8
MMZ1608D121C	120±25%	0.30	400	0.6
MMZ1608D121B	120±25%	0.30	400	0.8
MMZ1608D241C	240±25%	0.60	300	0.8
MMZ1608D301B	300±25%	0.70	300	0.8
MMZ1608F030B	3typ.	0.05	700	0.8
MMZ1608F470B	47±25%	0.40	500	0.8
MMZ1608F750B	75±25%	0.55	300	0.8
MMZ1608F121B	120±25%	0.75	200	0.8

\* Test equipment: E4991A or equivalent

Test tool: 16192A or equivalent

Test temperature: 25±10°C

### TYPICAL ELECTRICAL CHARACTERISTICS Z, X, R vs. FREQUENCY CHARACTERISTICS

**MMZ1608B121C**

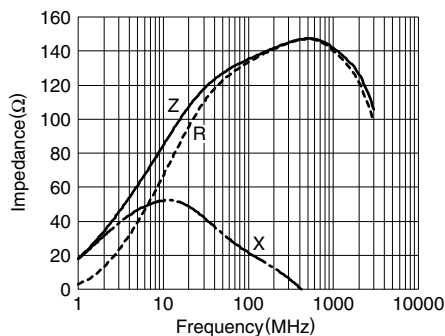

**MMZ1608B221C**

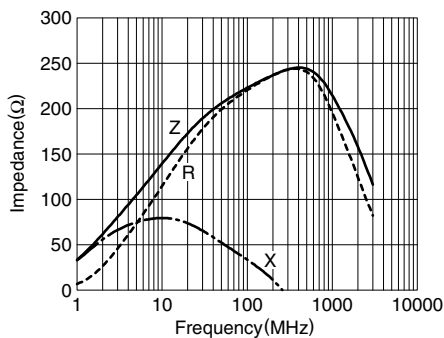

**MMZ1608B301C**

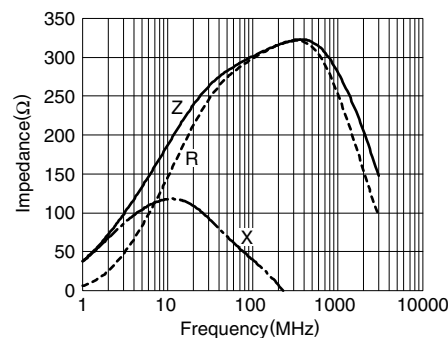

**MMZ1608B471C**

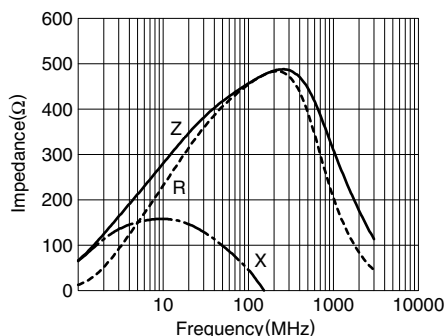

**MMZ1608B601C**

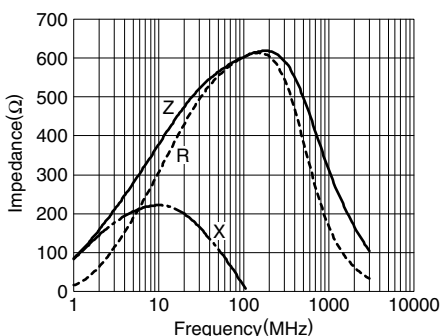

**MMZ1608B102C**

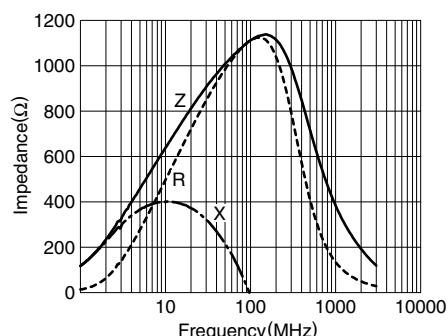

**MMZ1608R150A**

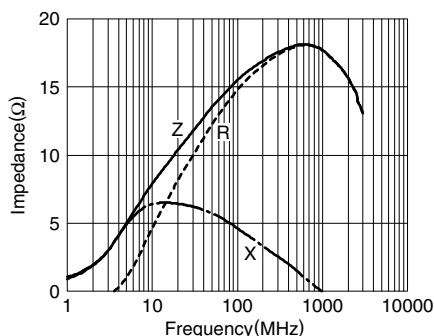

**MMZ1608R300A**

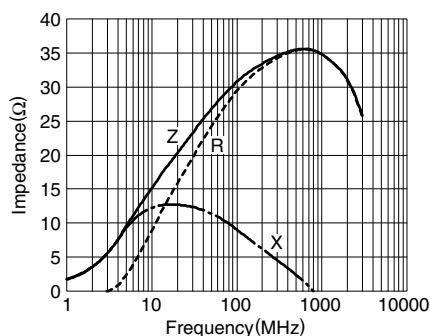

**MMZ1608R600A**

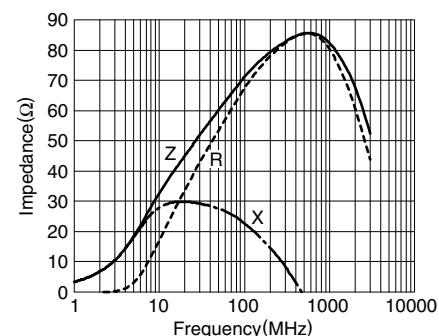

**MMZ1608R121A**

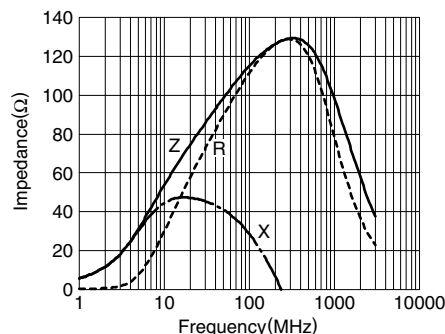

**MMZ1608R301A**

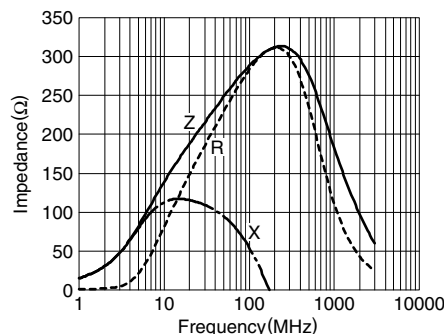

**MMZ1608R471A**

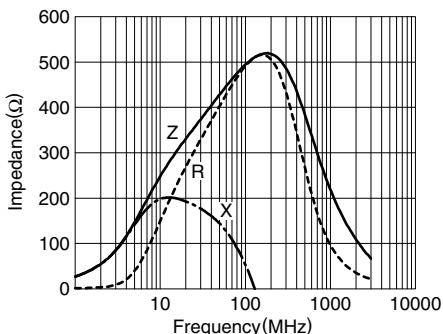

• All specifications are subject to change without notice.

### TYPICAL ELECTRICAL CHARACTERISTICS

#### Z, X, R vs. FREQUENCY CHARACTERISTICS

**MMZ1608R601A**

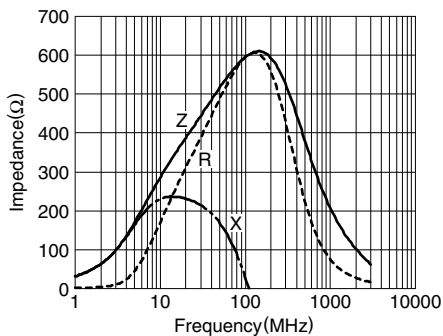

**MMZ1608R102A**

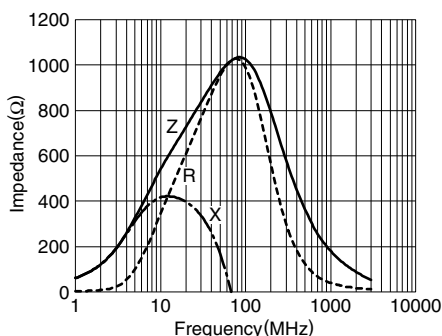

**MMZ1608S400A**

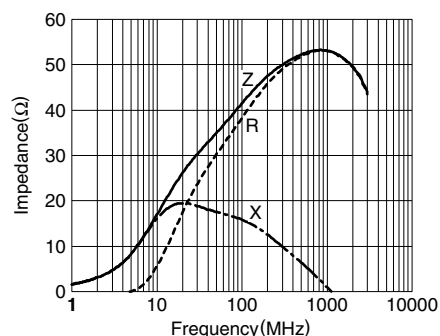

**MMZ1608S800A**

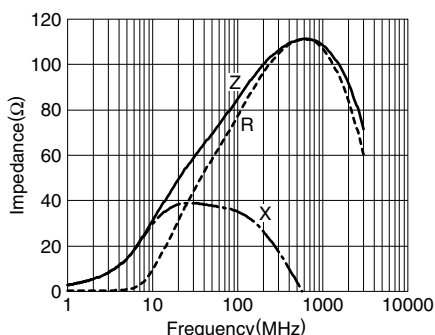

**MMZ1608S121A**

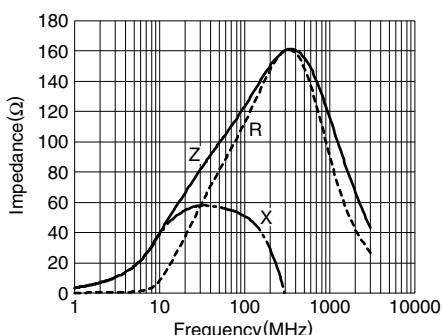

**MMZ1608S181A**

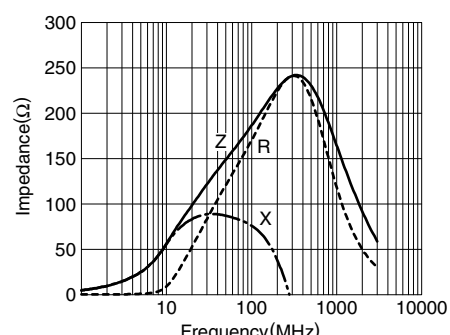

**MMZ1608S221A**

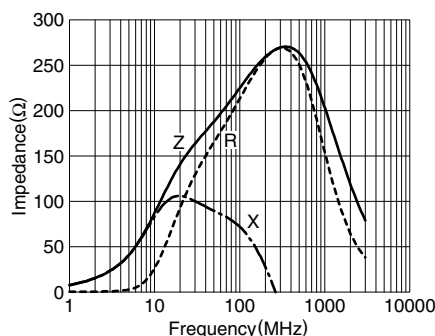

**MMZ1608S301A**

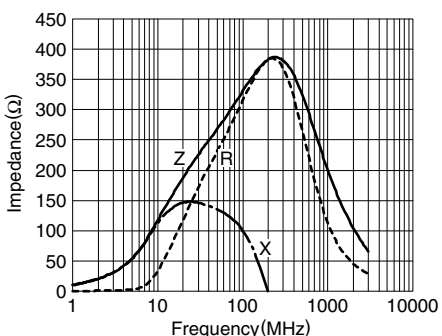

**MMZ1608S471A**

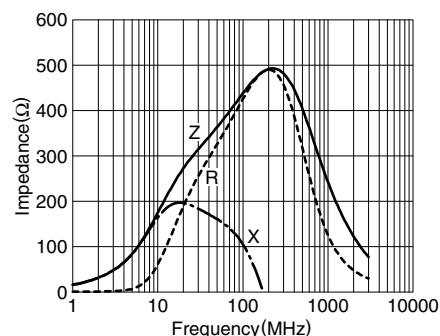

**MMZ1608S601A**

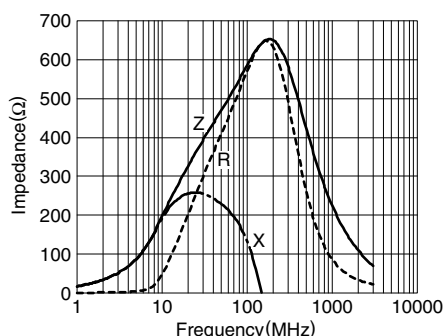

**MMZ1608S102A**

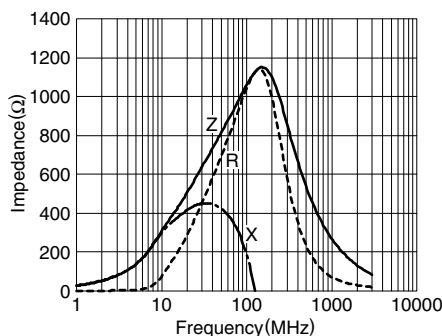

**MMZ1608S202A**

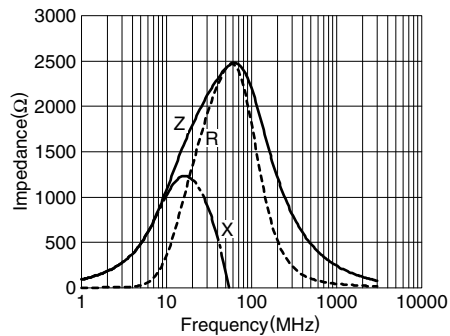

• All specifications are subject to change without notice.



### TYPICAL ELECTRICAL CHARACTERISTICS

#### Z, X, R vs. FREQUENCY CHARACTERISTICS

**MMZ1608Y150B**

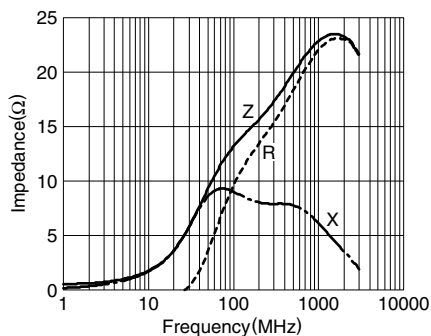

**MMZ1608Y300B**

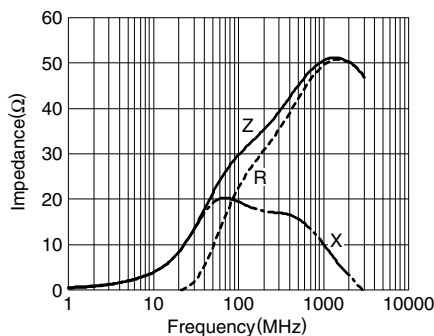

**MMZ1608Y600B**

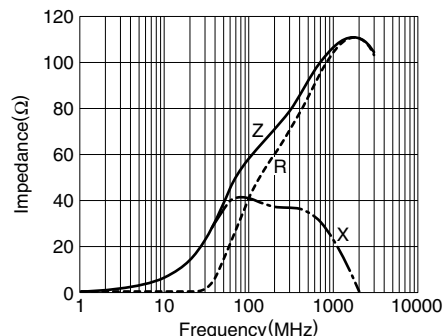

**MMZ1608Y121B**

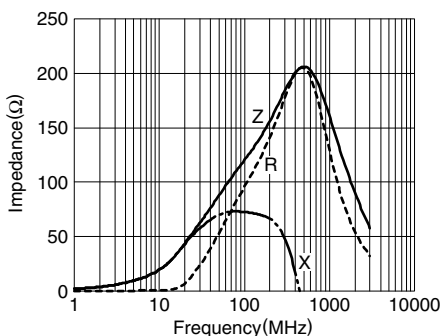

**MMZ1608Y221B**

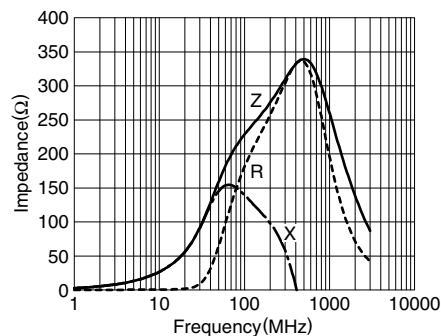

**MMZ1608Y301B**

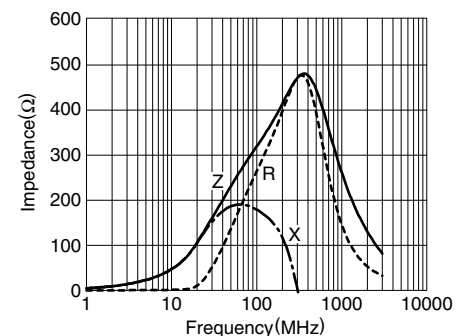

**MMZ1608Y471B**

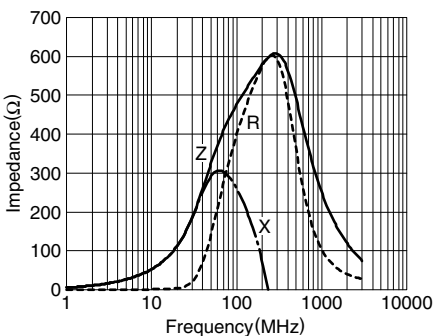

**MMZ1608Y601B**

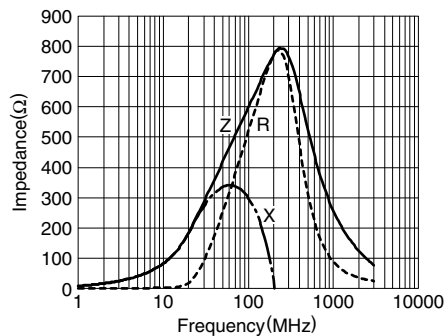

**MMZ1608Y751B**

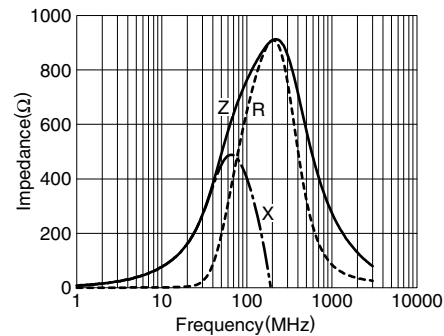

**MMZ1608Y102B**

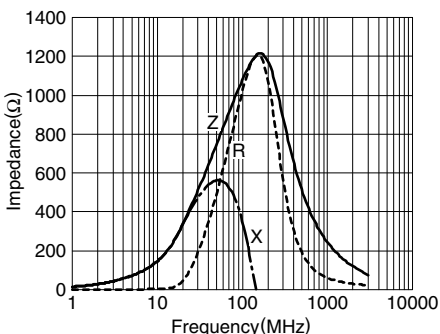

**MMZ1608Y152B**

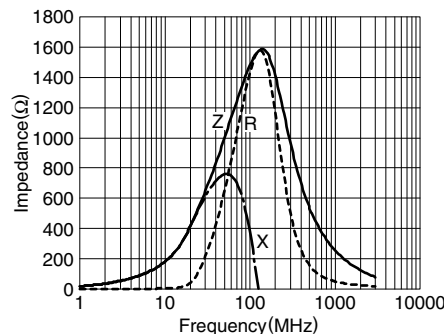

• All specifications are subject to change without notice.

### TYPICAL ELECTRICAL CHARACTERISTICS Z, X, R vs. FREQUENCY CHARACTERISTICS

**MMZ1608A182B**

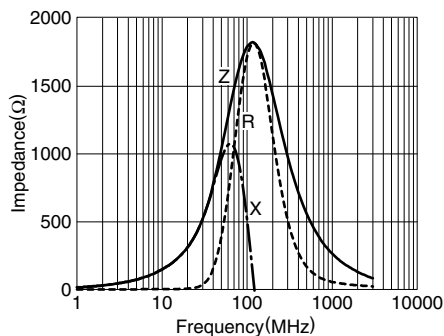

**MMZ1608A222B**

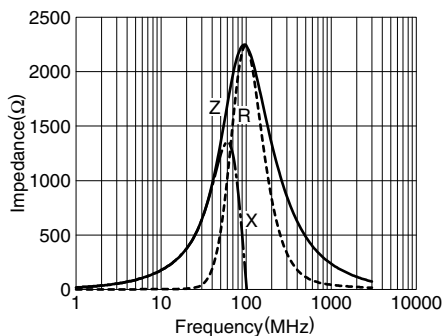

**MMZ1608A252B**

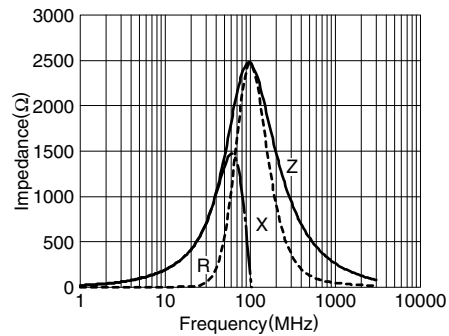

**MMZ1608Q121B**

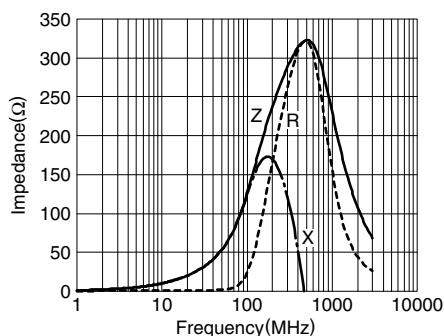

**MMZ1608Q221B**

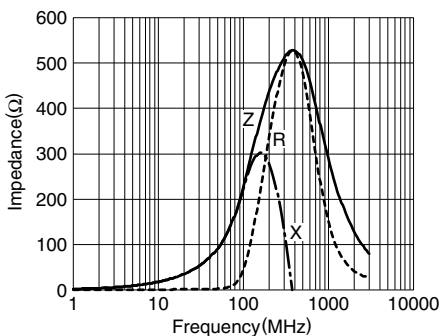

**MMZ1608Q331B**

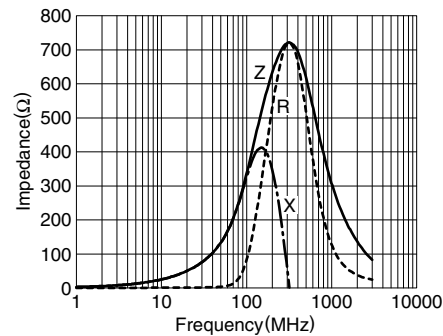

**MMZ1608Q471B**

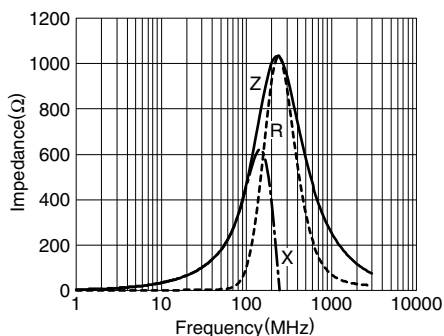

**MMZ1608Q601B**

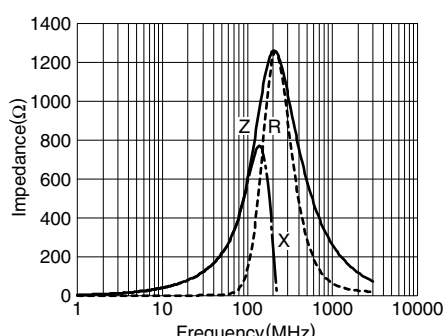

**MMZ1608Q102B**

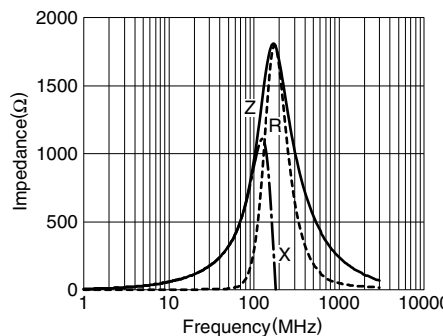

**MMZ1608D050C**

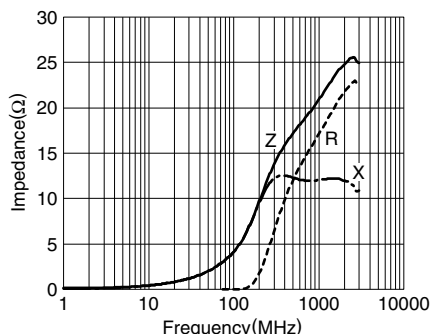

**MMZ1608D100C**

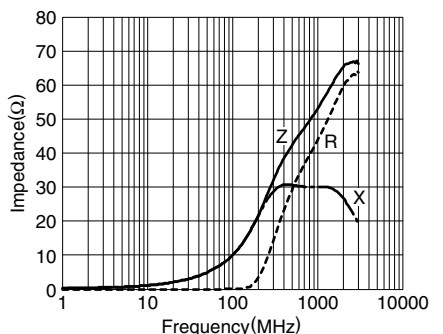

**MMZ1608D220C**

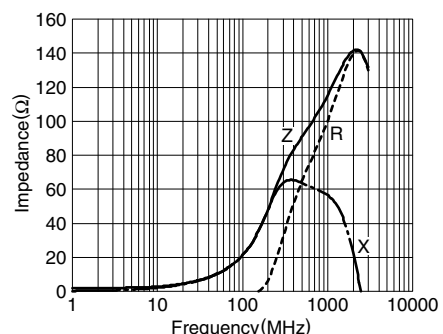

• All specifications are subject to change without notice.

### TYPICAL ELECTRICAL CHARACTERISTICS

#### Z, X, R vs. FREQUENCY CHARACTERISTICS

**MMZ1608D500C**

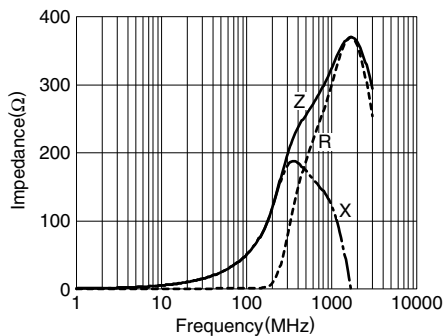

**MMZ1608D800C**

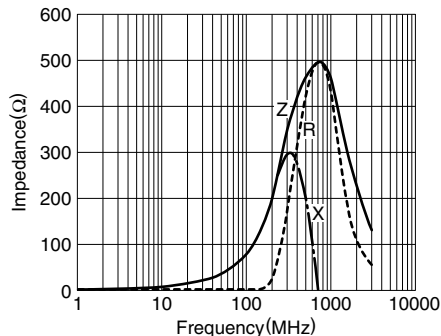

**MMZ1608D800B**

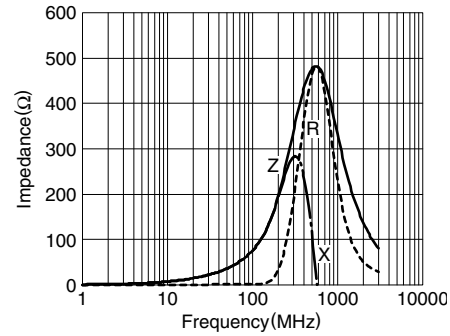

**MMZ1608D121C**

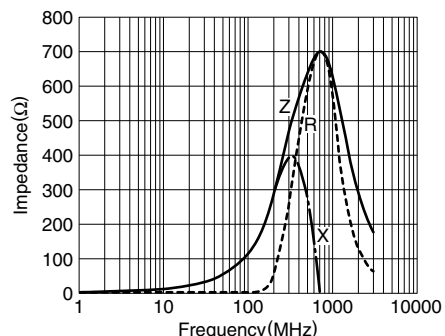

**MMZ1608D121B**

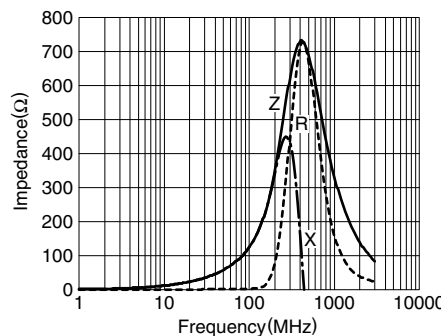

**MMZ1608D241C**

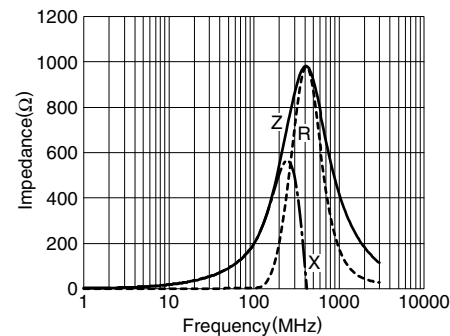

**MMZ1608D301B**

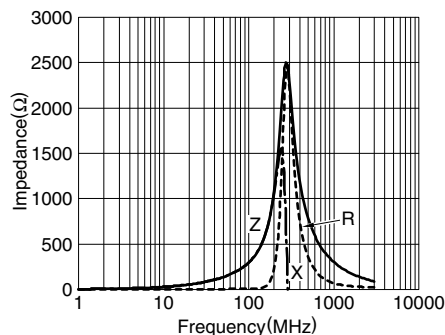

**MMZ1608F030B**

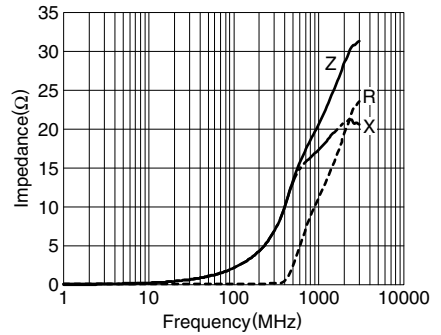

**MMZ1608F470B**

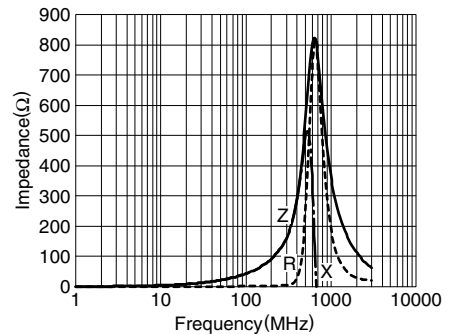

**MMZ1608F750B**

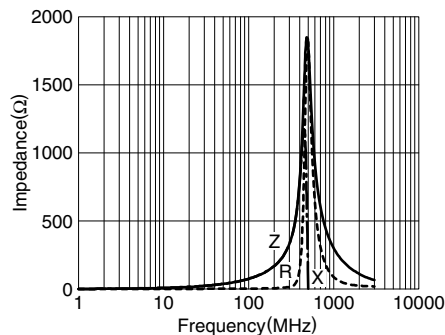

**MMZ1608F121B**

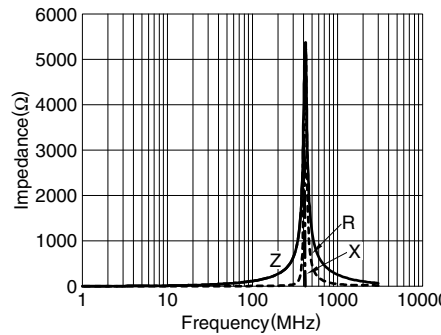

• All specifications are subject to change without notice.

**PACKAGING STYLES**  
**REEL DIMENSIONS**

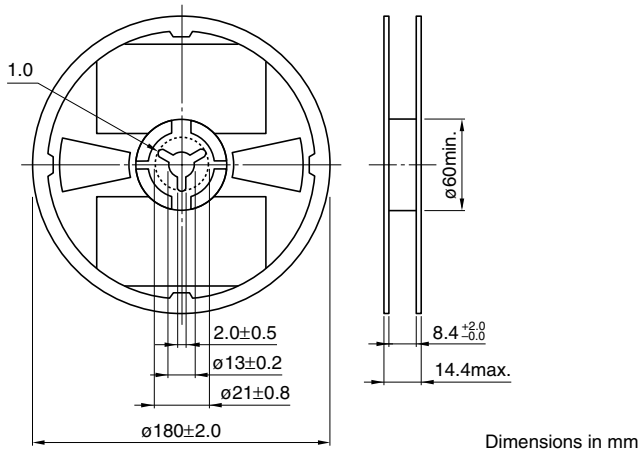

**TAPE DIMENSIONS**

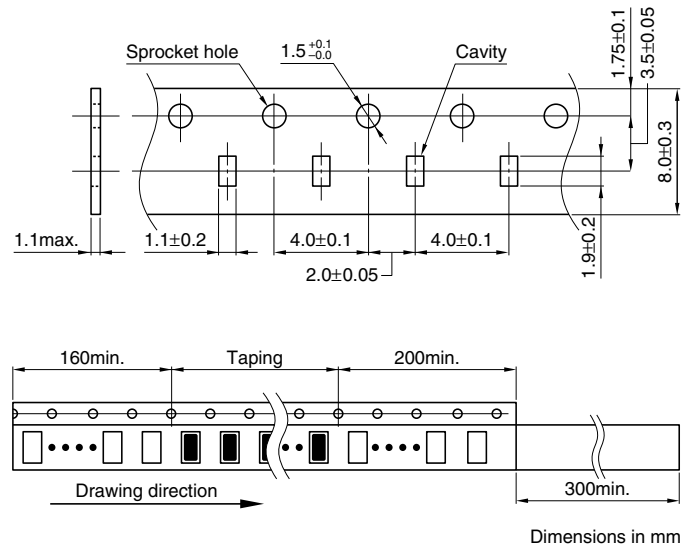

• All specifications are subject to change without notice.

# Chip Beads For Signal Line

Conformity to RoHS Directive

## MMZ Series MMZ2012

### FEATURES

- Chip bead(impeder), MMZ series offers 4 construction materials.
- Size standardized for use by automatic assembly equipment. No preferred orientation.
- Either flow or reflow soldering methods can be used due to electroplating of the terminal electrodes.
- High reliability due to an entirely monolithic structure.
- Closed magnetic circuit structure allows high-density installation while preventing crosstalk between circuits.
- Low DC resistance structure of electrode prevents wasteful electric power consumption.
- The products contain no lead and also support lead-free soldering.
- It is a product conforming to RoHS directive.

### APPLICATIONS

Removal of signal line noises of cellular phones, PCs, note PCs, TVs, TV tuners, STBs, audio players, DVDs, DSCs, DVCs, game machines, digital photo frames, car navigation system, PNDs, etc.

### PRODUCT IDENTIFICATION

MMZ	2012	R	121	A	T	□□□
(1)	(2)	(3)	(4)	(5)	(6)	(7)

- (1) Series name
- (2) Dimensions L×W
- (3) Type name
- (4) Impedance  
121:120Ω at 100MHz
- (5) Characteristic type
- (6) Packaging style  
T:Taping
- (7) TDK internal code

### HANDLING AND PRECAUTIONS

- Before soldering, be sure to preheat components. The preheating temperature should be set so that the temperature difference between the solder temperature and product temperature does not exceed 150°C.
- After mounting components onto the printed circuit board, do not apply stress through board bending or mishandling.
- Do not expose the inductors to stray magnetic fields.
- Avoid static electricity discharge during handling.
- When hand soldering, apply the soldering iron to the printed circuit board only. Temperature of the iron tip should not exceed 350°C. Soldering time should not exceed 3 seconds.

• Conformity to RoHS Directive: This means that, in conformity with EU Directive 2002/95/EC, lead, cadmium, mercury, hexavalent chromium, and specific bromine-based flame retardants, PBB and PBDE, have not been used, except for exempted applications.

• Please contact our Sales office when your application is considered the following:  
The device's failure or malfunction may directly endanger human life (e.g. application for automobile/aircraft/medical/nuclear power devices, etc.)

• All specifications are subject to change without notice.

### MATERIAL CHARACTERISTICS

- R material:** For wide frequency applications calling for broad impedance characteristics.  
For digital signal line applications calling requiring good waveform integrity. Impedance values selected for effectiveness at 10 to 200MHz.
- S material:** Standard type that features impedance characteristics similar to those of a typical ferrite core.  
For signal line applications in which the blocking region is near 100MHz. Impedance values selected for effectiveness at 40 to 300MHz.
- Y material:** High frequency range type intended for the 100MHz region and above.  
For signal line applications in which the signal frequency is far from the cutoff frequency. Impedance values selected for effectiveness at 80 to 400MHz.
- D material:** For applications calling for low insertion loss at low frequencies and sharply increasing impedance at high frequencies. Designed for high impedance at high frequencies (200 to 500MHz) for signal line applications.

### TYPICAL MATERIAL CHARACTERISTICS

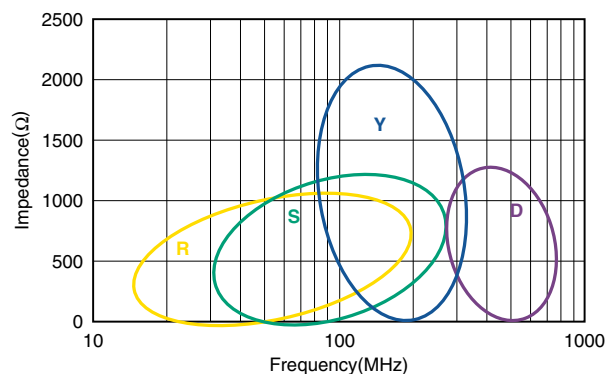

**SHAPES AND DIMENSIONS/RECOMMENDED PC BOARD**

**PATTERN**

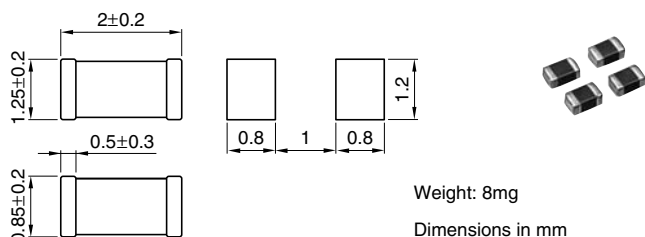

**SPECIFICATIONS**

Operating temperature range	-55 to +125°C
Storage temperature range	-55 to +125°C(After mount)

**PACKAGING STYLE AND QUANTITIES**

Packaging style	Quantity
Taping	4000 pieces/reel

**RECOMMENDED SOLDERING CONDITION**

**REFLOW SOLDERING**

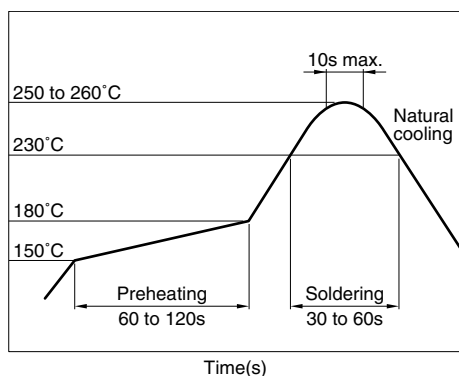

**ELECTRICAL CHARACTERISTICS**

Part No.	Impedance (Ω)[100MHz]*	DC resistance (Ω)max.	Rated current (mA)max.
MMZ2012R150A	15±25%	0.05	1500
MMZ2012R300A	30±25%	0.05	1500
MMZ2012R600A	60±25%	0.10	1000
MMZ2012R121A	120±25%	0.12	800
MMZ2012R301A	300±25%	0.15	600
MMZ2012R601A	600±25%	0.20	500
MMZ2012R102A	1000±25%	0.30	500
MMZ2012S400A	40±25%	0.10	1000
MMZ2012S800A	80±25%	0.10	800
MMZ2012S121A	120±25%	0.15	800
MMZ2012S181A	180±25%	0.15	600
MMZ2012S301A	300±25%	0.20	600
MMZ2012S601A	600±25%	0.30	500
MMZ2012S102A	1000±25%	0.35	500
MMZ2012Y150B	15±25%	0.05	1500
MMZ2012Y300B	30±25%	0.05	1500
MMZ2012Y600B	60±25%	0.10	1000
MMZ2012Y121B	120±25%	0.12	800
MMZ2012Y301B	300±25%	0.15	600
MMZ2012Y601B	600±25%	0.20	500
MMZ2012Y102B	1000±25%	0.30	500
MMZ2012Y152B	1500±25%	0.40	500
MMZ2012Y202B	2000±25%	0.50	400
MMZ2012D800B	80±25%	0.30	500
MMZ2012D121B	120±25%	0.30	500
MMZ2012D301B	300±25%	0.50	400

\* Test equipment: E4991A or equivalent  
 Test tool: 16192A or equivalent  
 Test temperature: 25±10°C

**TYPICAL ELECTRICAL CHARACTERISTICS**  
**Z, X, R vs. FREQUENCY CHARACTERISTICS**

**MMZ2012R150A**

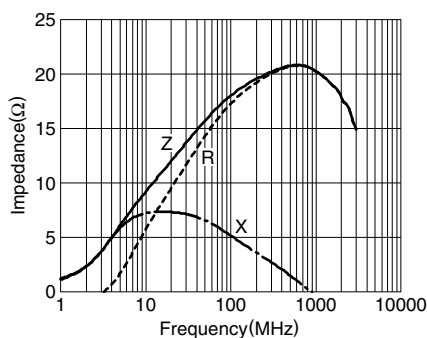

**MMZ2012R300A**

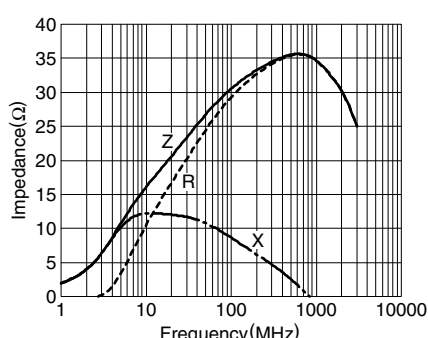

**MMZ2012R600A**

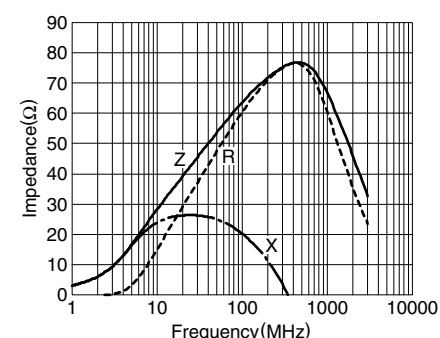

**MMZ2012R121A**

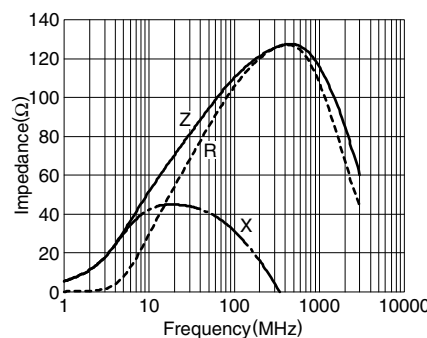

**MMZ2012R301A**

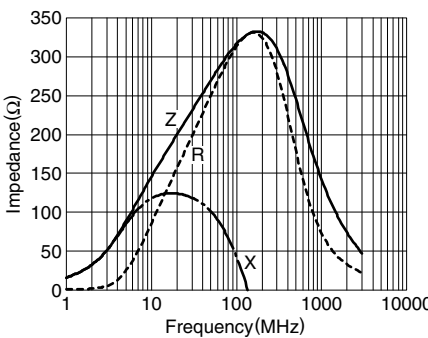

**MMZ2012R601A**

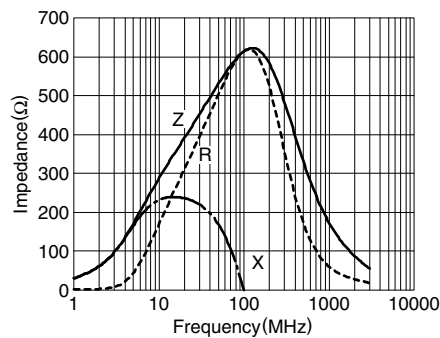

• All specifications are subject to change without notice.

### TYPICAL ELECTRICAL CHARACTERISTICS Z, X, R vs. FREQUENCY CHARACTERISTICS

**MMZ2012R102A**

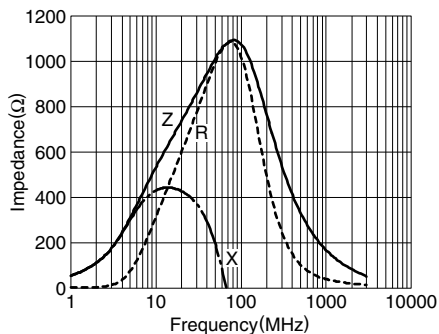

**MMZ2012S400A**

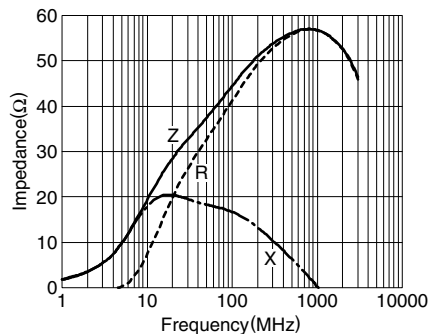

**MMZ2012S800A**

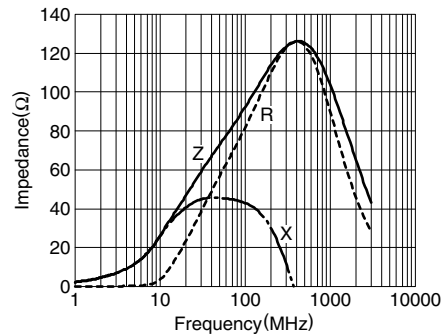

**MMZ2012S121A**

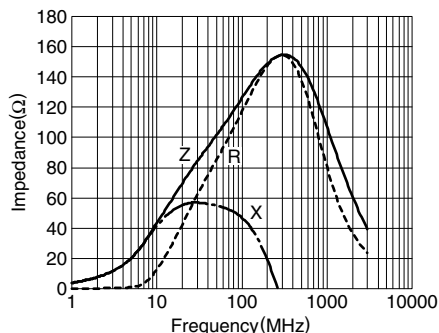

**MMZ2012S181A**

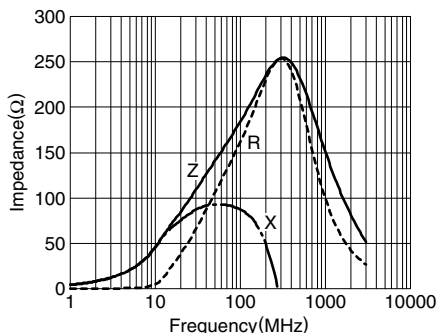

**MMZ2012S301A**

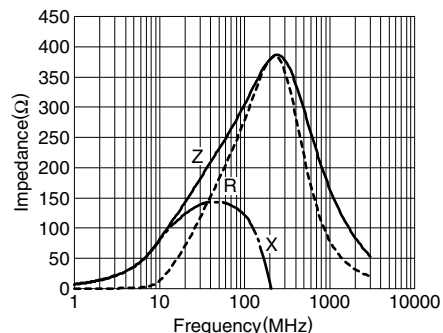

**MMZ2012S601A**

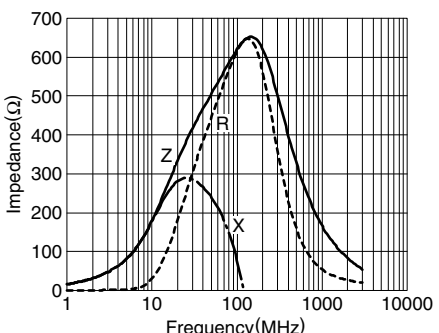

**MMZ2012S102A**

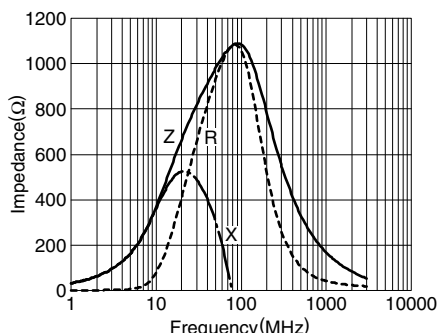

**MMZ2012Y150B**

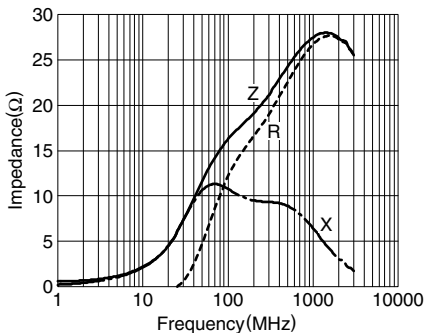

**MMZ2012Y300B**

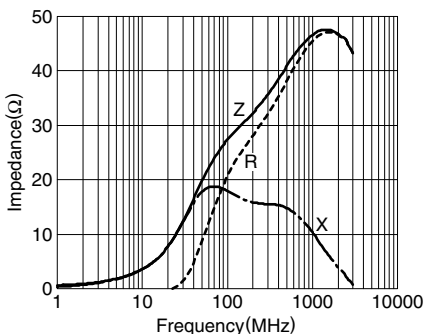

**MMZ2012Y600B**

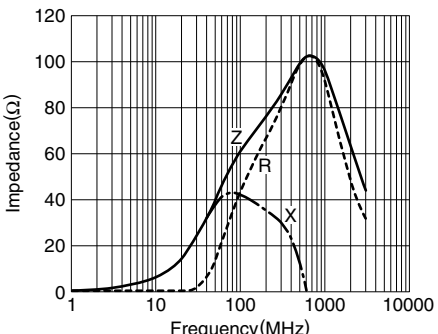

**MMZ2012Y121B**

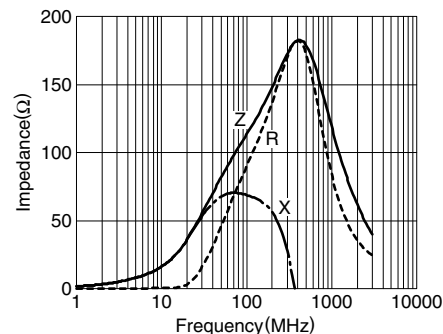

• All specifications are subject to change without notice.

**TYPICAL ELECTRICAL CHARACTERISTICS**

**Z, X, R vs. FREQUENCY CHARACTERISTICS**

**MMZ2012Y301B**

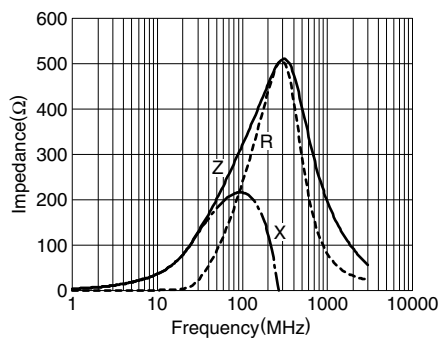

**MMZ2012Y601B**

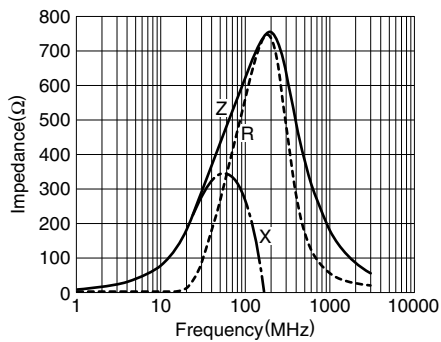

**MMZ2012Y102B**

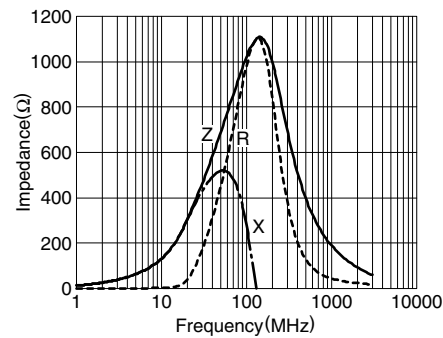

**MMZ2012Y152B**

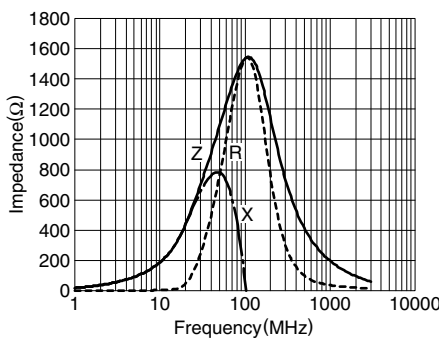

**MMZ2012Y202B**

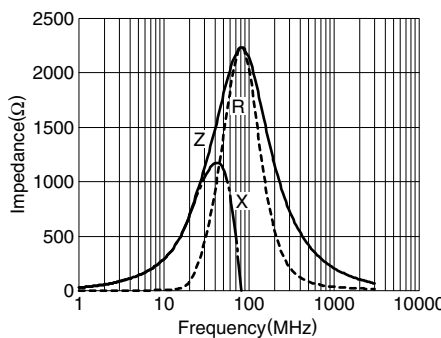

**MMZ2012D800B**

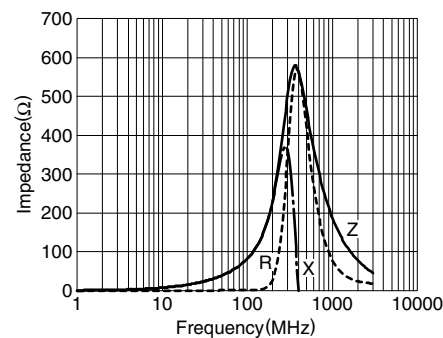

**MMZ2012D121B**

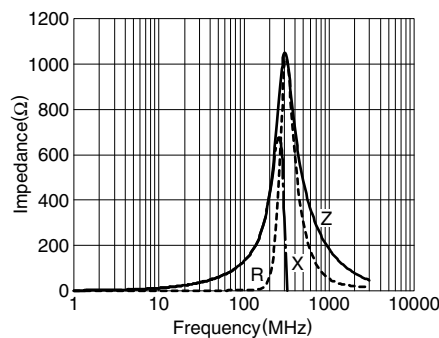

**MMZ2012D301B**

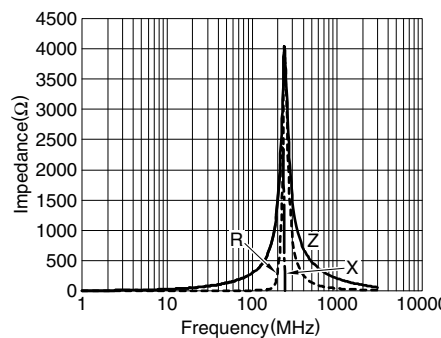

**PACKAGING STYLES**

**REEL DIMENSIONS**

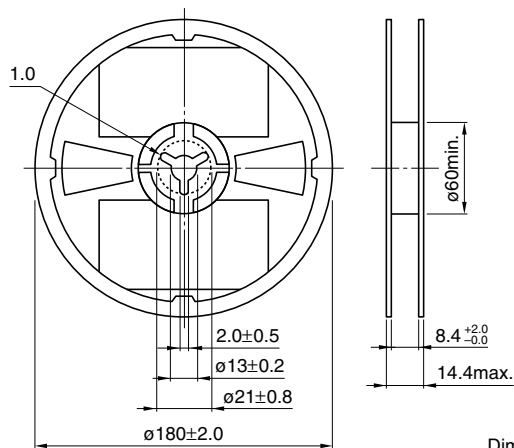

Dimensions in mm

**TAPE DIMENSIONS**

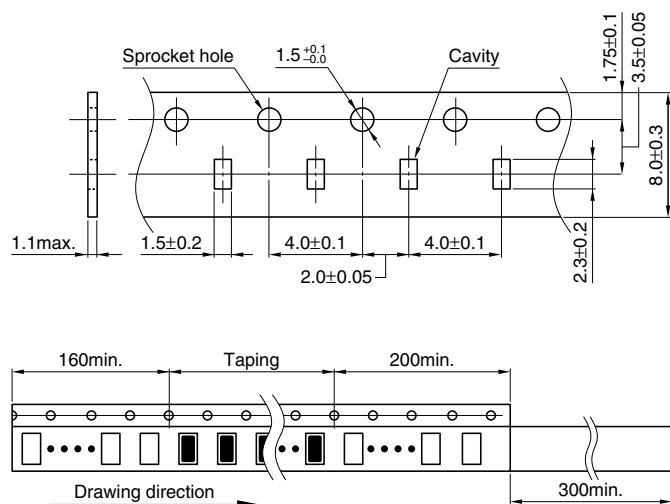

Dimensions in mm

• All specifications are subject to change without notice.



# Chip Beads For Signal Line

Conformity to RoHS Directive

## MMZ Series MMZ0603-E

### FEATURES

- This is a multilayered chip bead product with dimensions of L0.6×W0.3×T0.3mm.
- Compared with the existing MMZ0603 type, this new product has broad-band impedance values for higher frequency ranges.
- The product is magnetically shielded, allowing high density mounting.
- We refined the rules for internal conductor design to reduce floating capacity between conductors, which in turn has contributed to a dramatic improvement in high frequency characteristics. We have also been able to expand and reinforce the EMI suppression in the GHz range.
- It is a product conforming to RoHS directive.

### APPLICATIONS

Removal of signal line noises of cellular phones, portable audio players, various modules, DSCs, portable game machines, etc.

### PRODUCT IDENTIFICATION

MMZ 0603 S 102 E T   
 (1) (2) (3) (4) (5) (6) (7)

- (1) Series name
- (2) Dimensions L×W
- (3) Type name
- (4) Impedance  
102:1000Ω at 100MHz
- (5) Characteristic type
- (6) Packaging style  
T:Taping
- (7) TDK internal code

### HANDLING AND PRECAUTIONS

- Before soldering, be sure to preheat components. The preheating temperature should be set so that the temperature difference between the solder temperature and product temperature does not exceed 150°C.
- After mounting components onto the printed circuit board, do not apply stress through board bending or mishandling.
- Do not expose the inductors to stray magnetic fields.
- Avoid static electricity discharge during handling.
- When hand soldering, apply the soldering iron to the printed circuit board only. Temperature of the iron tip should not exceed 350°C. Soldering time should not exceed 3 seconds.

### SHAPES AND DIMENSIONS/RECOMMENDED PC BOARD PATTERN

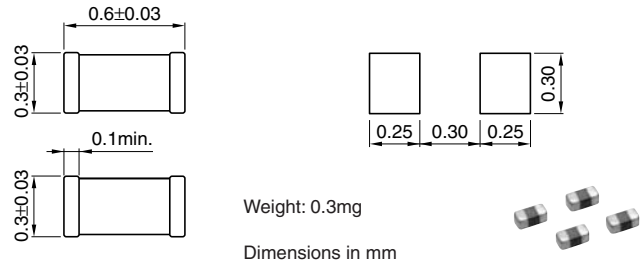

### SPECIFICATIONS

Operating temperature range	-55 to +125°C
Storage temperature range	-55 to +125°C(After mount)

### PACKAGING STYLE AND QUANTITIES

Packaging style	Quantity
Taping	15000 pieces/reel

### RECOMMENDED SOLDERING CONDITION

#### REFLOW SOLDERING

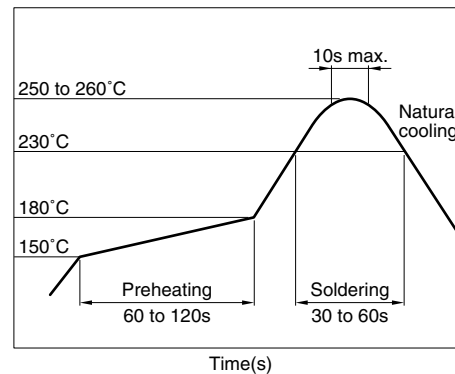

### ELECTRICAL CHARACTERISTICS

Part No.	Impedance(Ω)*		DC resistance (Ω)max.	Rated current (mA)max.
	[100MHz]	[1GHz]		
MMZ0603S601E	600±25%	1000±40%	1.60	150
MMZ0603S102E	1000±25%	1800±40%	2.60	125

\* Test equipment: E4991A or equivalent  
 Test tool: 16197 or equivalent  
 Test temperature: 25±10°C

• Conformity to RoHS Directive: This means that, in conformity with EU Directive 2002/95/EC, lead, cadmium, mercury, hexavalent chromium, and specific bromine-based flame retardants, PBB and PBDE, have not been used, except for exempted applications.

• Please contact our Sales office when your application is considered the following:  
 The device's failure or malfunction may directly endanger human life (e.g. application for automobile/aircraft/medical/nuclear power devices, etc.)

• All specifications are subject to change without notice.

**TYPICAL ELECTRICAL CHARACTERISTICS**  
**Z FREQUENCY CHARACTERISTICS(DIFFERS ACCORDING TO SERIES)**  
**MMZ0603S-E SERIES**

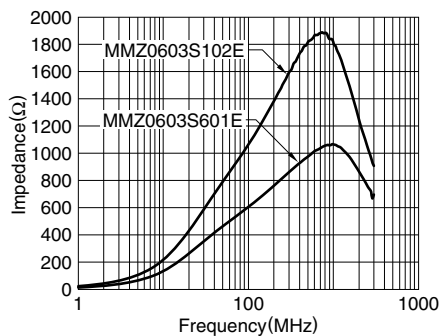

**TYPICAL ELECTRICAL CHARACTERISTICS**  
**Z, X, R vs. FREQUENCY CHARACTERISTICS**  
**MMZ0603S601E**

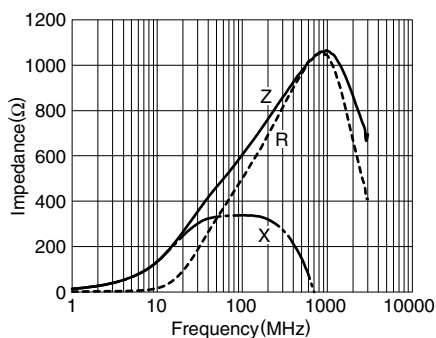

**MMZ0603S102E**

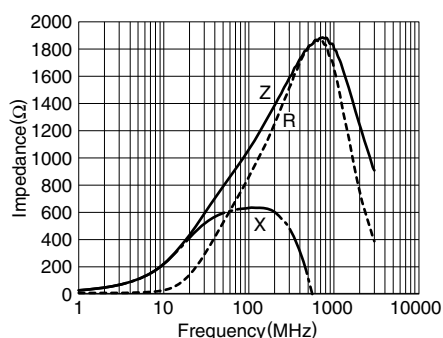

**PACKAGING STYLES**  
**REEL DIMENSIONS**

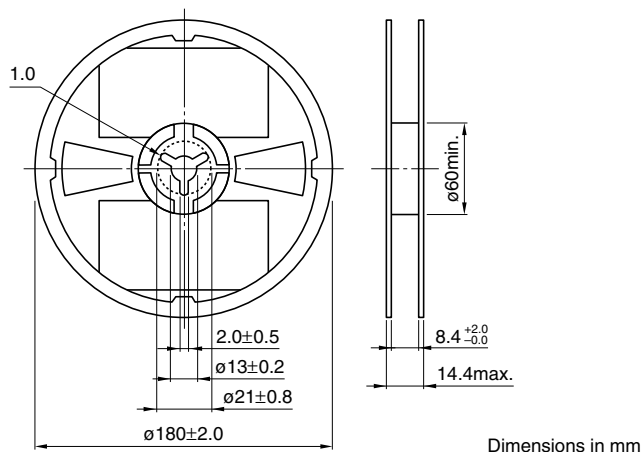

Dimensions in mm

**TAPE DIMENSIONS**

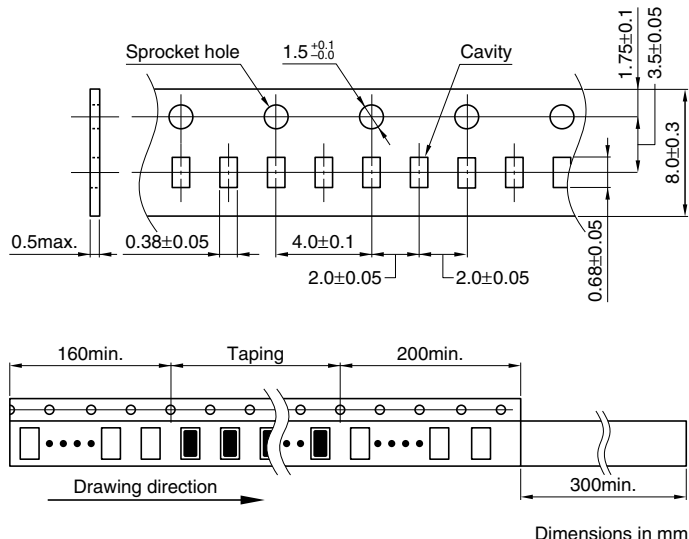

Dimensions in mm

• All specifications are subject to change without notice.

# Chip Beads For Signal Line

Conformity to RoHS Directive

## MMZ Series MMZ1005-E

### FEATURES

- Compared with the existing MMZ1005 type, this new product has broad-band impedance values for higher frequency ranges.
- Size standardized for use by automatic assembly equipment. No preferred orientation.
- Electroplated terminal electrodes accommodate reflow soldering.
- High reliability due to an entirely monolithic structure.
- Closed magnetic circuit structure allows high-density installation while preventing crosstalk between circuits.
- Low DC resistance structure of electrode prevents wasteful electric power consumption.
- It is a product conforming to RoHS directive.

### APPLICATIONS

Removal of signal line noises of cellular phones, PCs, note PCs, TVs, TV tuners, STBs, audio players, DVDs, DSCs, DVCs, game machines, digital photo frames, car navigation system, PNDs, etc.

### SPECIFICATIONS

Operating temperature range	-55 to +125°C
Storage temperature range	-55 to +125°C(After mount)

### SHAPES AND DIMENSIONS/RECOMMENDED PC BOARD PATTERN

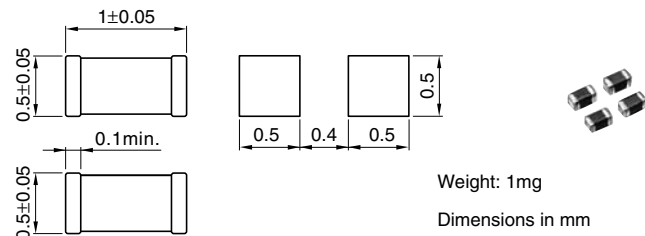

### ELECTRICAL CHARACTERISTICS

Part No.	Impedance(Ω)*		DC resistance (Ω)max.	Rated current (mA)max.
	[100MHz]	[1GHz]		
MMZ1005S601E	600±25%	1000±40%	0.65	300
MMZ1005S102E	1000±25%	1400±40%	1.00	250
MMZ1005S182E	1800±25%	1800±40%	1.50	200
MMZ1005A601E	600±25%	1400±40%	0.80	300
MMZ1005A102E	1000±25%	2000±40%	1.20	250
MMZ1005A152E	1500±25%	2300±40%	1.60	230
MMZ1005A182E	1800±25%	2700±40%	2.10	200
MMZ1005A222E	2200±25%	3000±40%	2.20	150
MMZ1005D121E	120±25%	1000±40%	0.70	300
MMZ1005D221E	220±25%	1700±40%	1.00	250
MMZ1005F470E	47±25%	800±40%	0.70	300
MMZ1005F750E	75±25%	1500±40%	1.00	250
MMZ1005F121E	120±25%	2300±40%	1.50	200

\* Test equipment: E4991A or equivalent  
Test tool: 16192A or equivalent  
Test temperature: 25±10°C

- Conformity to RoHS Directive: This means that, in conformity with EU Directive 2002/95/EC, lead, cadmium, mercury, hexavalent chromium, and specific bromine-based flame retardants, PBB and PBDE, have not been used, except for exempted applications.

- Please contact our Sales office when your application is considered the following:  
The device's failure or malfunction may directly endanger human life (e.g. application for automobile/aircraft/medical/nuclear power devices, etc.)

- All specifications are subject to change without notice.

### PRODUCT IDENTIFICATION

MMZ	1005	S	601	E	T	□□□
(1)	(2)	(3)	(4)	(5)	(6)	(7)

- (1) Series name
- (2) Dimensions L×W
- (3) Type name
- (4) Impedance  
601:600Ω at 100MHz
- (5) Characteristic type
- (6) Packaging style  
T:Taping
- (7) TDK internal code

### PACKAGING STYLE AND QUANTITIES

Packaging style	Quantity
Taping	10000 pieces/reel

### HANDLING AND PRECAUTIONS

- Before soldering, be sure to preheat components. The preheating temperature should be set so that the temperature difference between the solder temperature and product temperature does not exceed 150°C.
- After mounting components onto the printed circuit board, do not apply stress through board bending or mishandling.
- Do not expose the inductors to stray magnetic fields.
- Avoid static electricity discharge during handling.
- When hand soldering, apply the soldering iron to the printed circuit board only. Temperature of the iron tip should not exceed 350°C. Soldering time should not exceed 3 seconds.

### RECOMMENDED SOLDERING CONDITION REFLOW SOLDERING

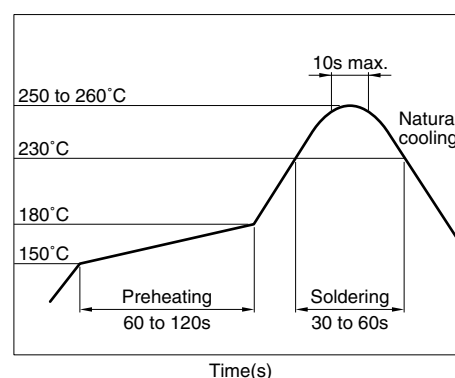

### TYPICAL ELECTRICAL CHARACTERISTICS

### Z FREQUENCY CHARACTERISTICS(DIFFERS ACCORDING TO SERIES)

#### MMZ1005S-E SERIES

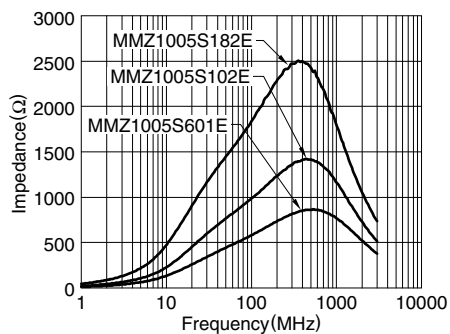

#### MMZ1005A-E SERIES

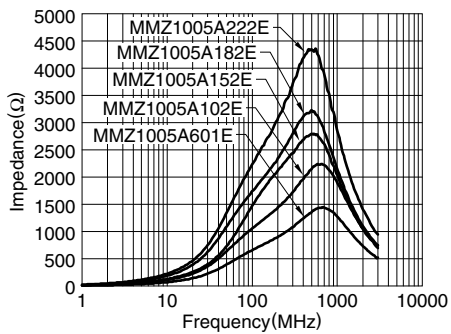

#### MMZ1005D-E SERIES

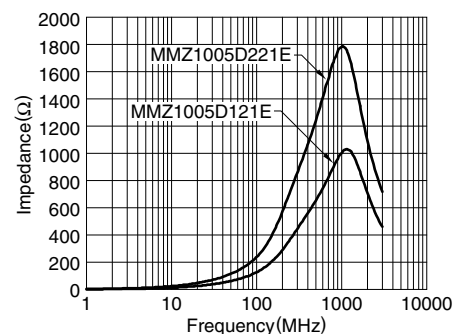

#### MMZ1005F-E SERIES

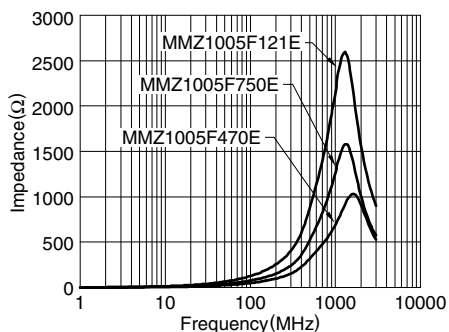

### Z, X, R vs. FREQUENCY CHARACTERISTICS

#### MMZ1005S601E

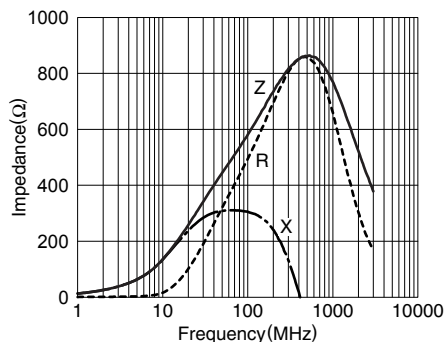

#### MMZ1005S102E

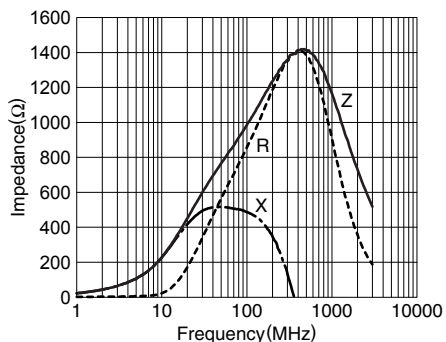

#### MMZ1005S182E

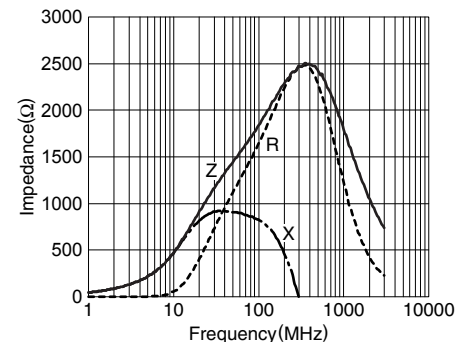

#### MMZ1005A601E

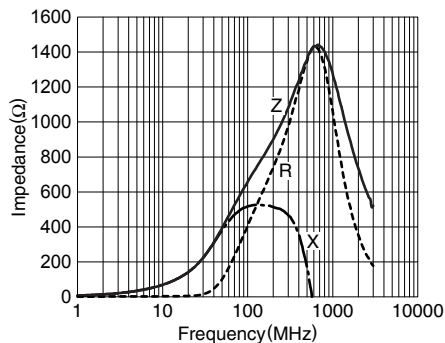

#### MMZ1005A102E

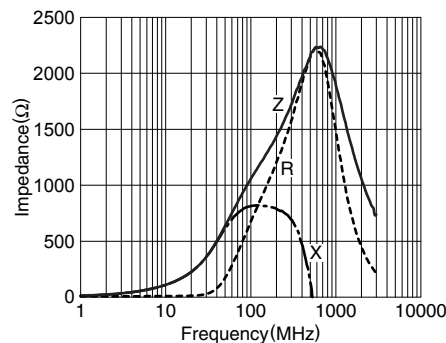

#### MMZ1005A152E

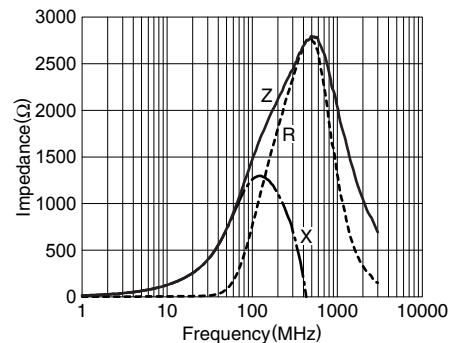

• All specifications are subject to change without notice.

**TYPICAL ELECTRICAL CHARACTERISTICS**  
**Z, X, R vs. FREQUENCY CHARACTERISTICS**

**MMZ1005A182E**

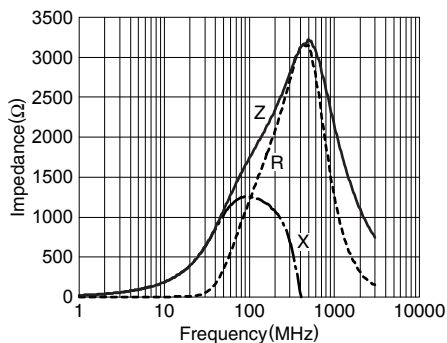

**MMZ1005A222E**

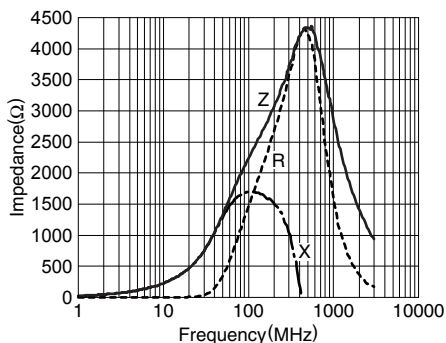

**MMZ1005D121E**

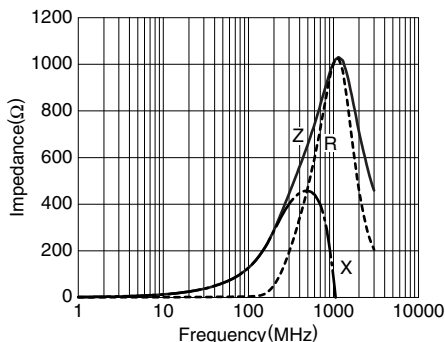

**MMZ1005D221E**

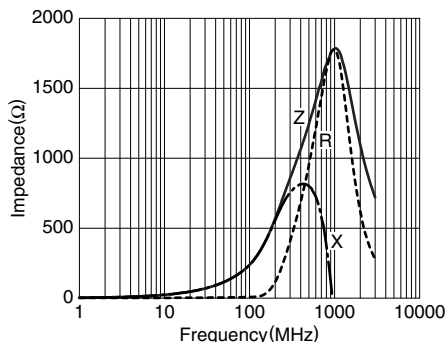

**MMZ1005F470E**

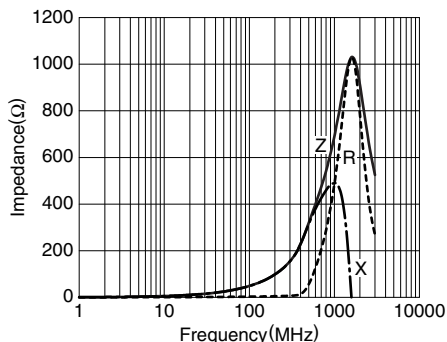

**MMZ1005F750E**

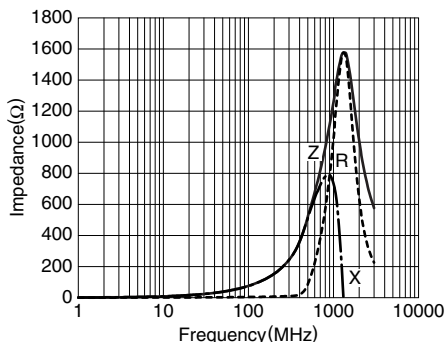

**MMZ1005F121E**

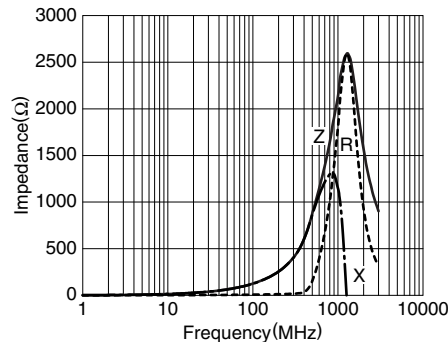

**PACKAGING STYLES**  
**REEL DIMENSIONS**

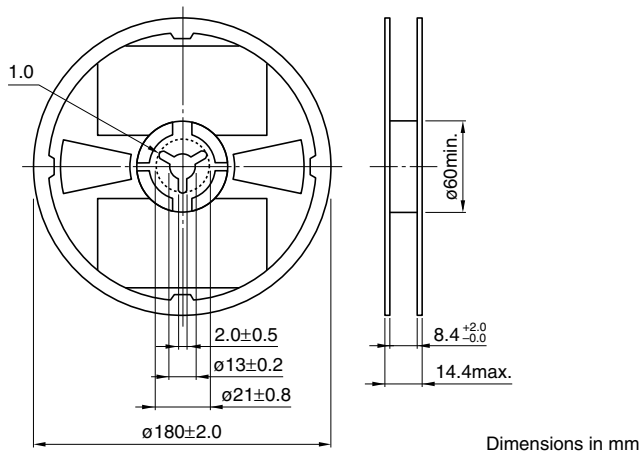

Dimensions in mm

**TAPE DIMENSIONS**

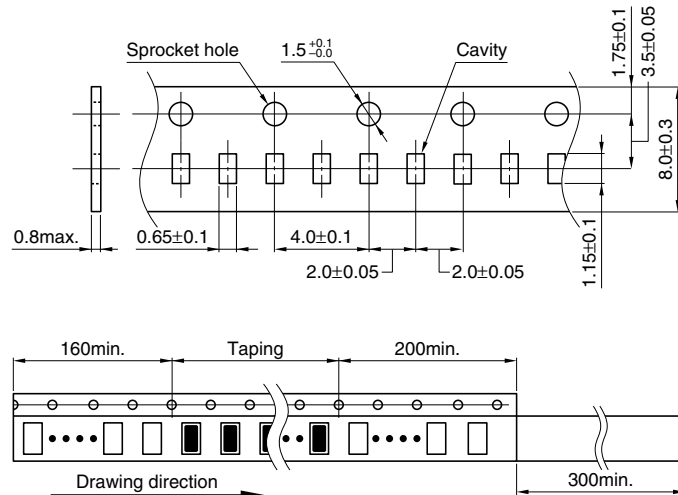

Dimensions in mm

• All specifications are subject to change without notice.

Компания «Life Electronics» занимается поставками электронных компонентов импортного и отечественного производства от производителей и со складов крупных дистрибьюторов Европы, Америки и Азии.

С конца 2013 года компания активно расширяет линейку поставок компонентов по направлению коаксиальный кабель, кварцевые генераторы и конденсаторы (керамические, пленочные, электролитические), за счёт заключения дистрибьюторских договоров

Мы предлагаем:

- Конкуренспособные цены и скидки постоянным клиентам.
- Специальные условия для постоянных клиентов.
- Подбор аналогов.
- Поставку компонентов в любых объемах, удовлетворяющих вашим потребностям.
- Приемлемые сроки поставки, возможна ускоренная поставка.
- Доставку товара в любую точку России и стран СНГ.
- Комплексную поставку.
- Работу по проектам и поставку образцов.
- Формирование склада под заказчика.
- Сертификаты соответствия на поставляемую продукцию (по желанию клиента).
- Тестирование поставляемой продукции.
- Поставку компонентов, требующих военную и космическую приемку.
- Входной контроль качества.
- Наличие сертификата ISO.

В составе нашей компании организован Конструкторский отдел, призванный помогать разработчикам, и инженерам.

Конструкторский отдел помогает осуществить:

- Регистрацию проекта у производителя компонентов.
- Техническую поддержку проекта.
- Защиту от снятия компонента с производства.
- Оценку стоимости проекта по компонентам.
- Изготовление тестовой платы монтаж и пусконаладочные работы.



Тел: +7 (812) 336 43 04 (многоканальный)

Email: [org@lifeelectronics.ru](mailto:org@lifeelectronics.ru)