



Device Overview

The 89HPES4T4 is a member of IDT's PRECISE™ family of PCI Express switching solutions. The PES4T4 is a 4-lane, 4-port peripheral chip that performs PCI Express Base switching. It provides connectivity and switching functions between a PCI Express upstream port and up to four downstream ports and supports switching between downstream ports.

Features

- ◆ **High Performance PCI Express Switch**
 - Four 2.5 Gbps PCI Express lanes
 - Four switch ports
 - x1 Upstream port
 - Three x1 Downstream ports
 - Low latency cut-through switch architecture
 - Support for Max payload sizes up to 256 bytes
 - One virtual channel
 - Eight traffic classes
 - PCI Express Base Specification Revision 1.1 compliant
- ◆ **Flexible Architecture with Numerous Configuration Options**
 - Automatic lane reversal on all ports
 - Automatic polarity inversion on all lanes
 - Ability to load device configuration from serial EEPROM
- ◆ **Legacy Support**
 - PCI compatible INTx emulation
 - Bus locking

- ◆ **Highly Integrated Solution**
 - Requires no external components
 - Incorporates on-chip internal memory for packet buffering and queueing
 - Integrates four 2.5 Gbps embedded SerDes with 8B/10B encoder/decoder (no separate transceivers needed)
- ◆ **Reliability, Availability, and Serviceability (RAS) Features**
 - Internal end-to-end parity protection on all TLPs ensures data integrity even in systems that do not implement end-to-end CRC (ECRC)
 - Supports ECRC and Advanced Error Reporting
 - Supports PCI Express Native Hot-Plug, Hot-Swap capable I/O
 - Compatible with Hot-Plug I/O expanders used on PC motherboards
- ◆ **Power Management**
 - Utilizes advanced low-power design techniques to achieve low typical power consumption
 - Supports PCI Power Management Interface specification (PCI-PM 1.2)
 - Unused SerDes are disabled.
 - Supports Advanced Configuration and Power Interface Specification, Revision 2.0 (ACPI) supporting active link state
- ◆ **Testability and Debug Features**
 - Built in Pseudo-Random Bit Stream (PRBS) generator
 - Numerous SerDes test modes
 - Ability to bypass link training and force any link into any mode
 - Provides statistics and performance counters

Block Diagram

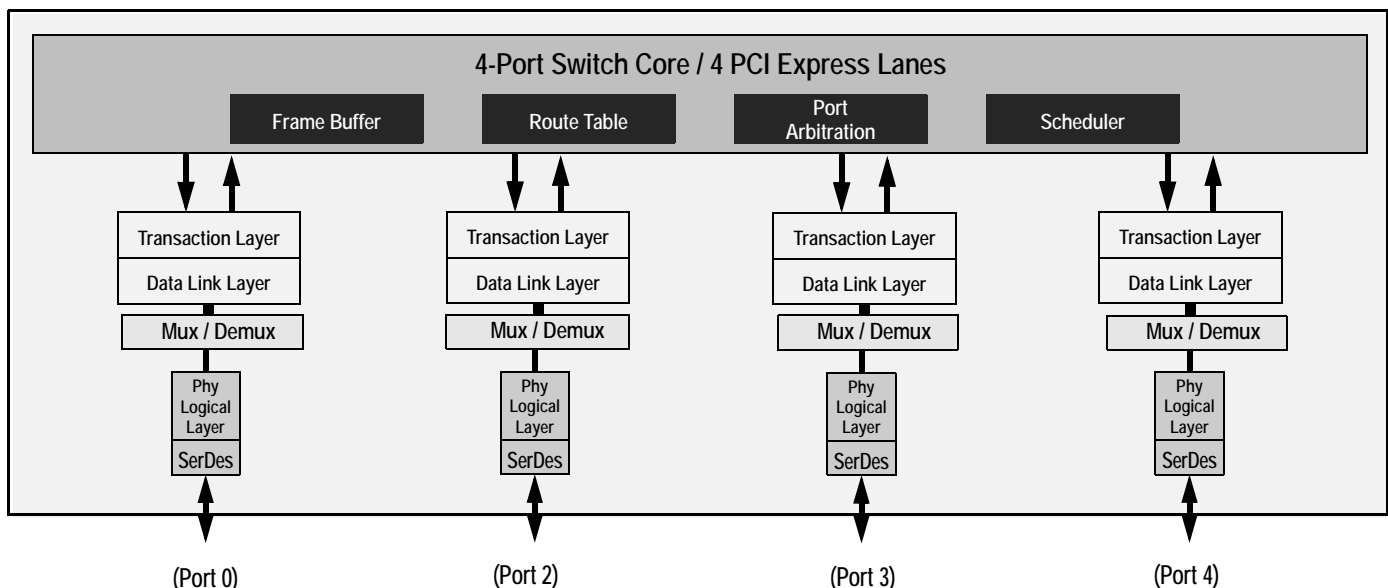

Figure 1 Internal Block Diagram

- ◆ 5 General Purpose Input/Output Pins
 - Each pin may be individually configured as an input or output
 - Each pin may be individually configured as an interrupt input
 - Each pin has a selectable alternate function
- ◆ Option A Package: 13mm x 13mm 144-ball BGA with 1mm ball spacing
- ◆ Option B Package: 10mm x 10mm 132-ball QFN with 1mm ball spacing

Product Description

Utilizing standard PCI Express interconnect, the PES4T4 provides the most efficient fan-out solution for applications requiring x1 connectivity, low latency, and simple board layout with a minimum number of board layers. Each lane provides 2.5 Gbps of bandwidth in both directions and is fully compliant with PCI Express Base specification 1.1.

The PES4T4 is based on a flexible and efficient layered architecture. The PCI Express layer consists of SerDes, Physical, Data Link and Transaction layers in compliance with PCI Express Base specification Revision 1.1. The PES4T4 can operate either as a store and forward or cut-through switch and is designed to switch memory and I/O transactions. It supports eight Traffic Classes (TCs) and one Virtual Channel (VC) with sophisticated resource management to allow efficient switching for applications requiring additional narrow port connectivity and also some high-end connectivity.

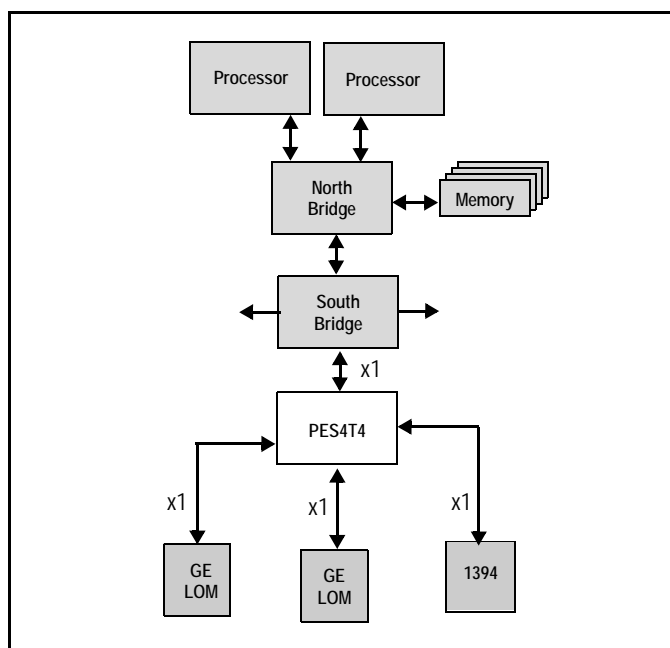

Figure 2 I/O Expansion Application

SMBus Interface

The PES4T4 contains an SMBus master interface. This master interface allows the default configuration register values of the PES4T4 to be overridden following a reset with values programmed in an external serial EEPROM. The master interface is also used by an external Hot-Plug I/O expander. Two pins make up the SMBus master interface. These pins consist of an SMBus clock pin and an SMBus data pin.

Hot-Plug Interface

The PES4T4 supports PCI Express Hot-Plug on each downstream port. To reduce the number of pins required on the device, the PES4T4 utilizes an external I/O expander, such as that used on PC motherboards, connected to the SMBus master interface. Following reset and configuration, whenever the state of a Hot-Plug output needs to be modified, the PES4T4 generates an SMBus transaction to the I/O expander with the new value of all of the outputs. Whenever a Hot-Plug input changes, the I/O expander generates an interrupt which is received on the IOEXPINTN input pin (alternate function of GPIO) of the PES4T4. In response to an I/O expander interrupt, the PES4T4 generates an SMBus transaction to read the state of all of the Hot-Plug inputs from the I/O expander.

General Purpose Input/Output

The PES4T4 provides 5 General Purpose Input/Output (GPIO) pins that may be used by the system designer as bit I/O ports. Each GPIO pin may be configured independently as an input or output through software control, and some GPIO pins are shared with another on-chip functions. These alternate functions may be enabled via software or serial configuration EEPROM.

Pin Description

The following tables lists the functions of the pins provided on the PES4T4. Some of the functions listed may be multiplexed onto the same pin. The active polarity of a signal is defined using a suffix. Signals ending with an "N" are defined as being active, or asserted, when at a logic zero (low) level. All other signals (including clocks, buses, and select lines) will be interpreted as being active, or asserted, when at a logic one (high) level.

| Signal | Type | Name/Description |
|------------------------|------|---|
| PE0RP[0] PE0RN[0] | I | PCI Express Port 0 Serial Data Receive. Differential PCI Express receive pair for port 0. |
| PE0TP[0] PE0TN[0] | O | PCI Express Port 0 Serial Data Transmit. Differential PCI Express transmit pair for port 0. |
| PE2RP[0] PE2RN[0] | I | PCI Express Port 2 Serial Data Receive. Differential PCI Express receive pair for port 2. |
| PE2TP[0] PE2TN[0] | O | PCI Express Port 2 Serial Data Transmit. Differential PCI Express transmit pair for port 2. |
| PE3RP[0] PE3RN[0] | I | PCI Express Port 3 Serial Data Receive. Differential PCI Express receive pair for port 3. |
| PE3TP[0] PE3TN[0] | O | PCI Express Port 3 Serial Data Transmit. Differential PCI Express transmit pair for port 3. |
| PE4RP[0] PE4RN[0] | I | PCI Express Port 4 Serial Data Receive. Differential PCI Express receive pair for port 4. |
| PE4TP[0] PE4TN[0] | O | PCI Express Port 4 Serial Data Transmit. Differential PCI Express transmit pair for port 4. |
| PEREFCLKP PEREFCLKN | I | PCI Express Reference Clock. Differential reference clock pair input. This clock is used as the reference clock by on-chip PLLs to generate the clocks required for the system logic and on-chip SerDes. |

Table 1 PCI Express Interface Pins

| Signal | Type | Name/Description |
|---------|------|--|
| MSMBCLK | I/O | Master SMBus Clock. This bidirectional signal is used to synchronize transfers on the master SMBus. |
| MSMBDAT | I/O | Master SMBus Data. This bidirectional signal is used for data on the master SMBus. |

Table 2 SMBus Interface Pins

| Signal | Type | Name/Description |
|---------|------|---|
| GPIO[0] | I/O | General Purpose I/O. This pin can be configured as a general purpose I/O pin. Alternate function pin name: P2RSTN Alternate function pin type: Output Alternate function: Reset output for downstream port 2 |
| GPIO[1] | I/O | General Purpose I/O. This pin can be configured as a general purpose I/O pin. Alternate function pin name: P4RSTN Alternate function pin type: Output Alternate function: Reset output for downstream port 4 |
| GPIO[2] | I/O | General Purpose I/O. This pin can be configured as a general purpose I/O pin. Alternate function pin name: IOEXPINTN0 Alternate function pin type: Input Alternate function: I/O Expander interrupt 0 input |
| GPIO[7] | I/O | General Purpose I/O. This pin can be configured as a general purpose I/O pin. Alternate function pin name: GPEN Alternate function pin type: Output Alternate function: General Purpose Event (GPE) output |
| GPIO[9] | I/O | General Purpose I/O. This pin can be configured as a general purpose I/O pin. Alternate function pin name: P3RSTN Alternate function pin type: Output Alternate function: Reset output for downstream port 3 |

Table 3 General Purpose I/O Pins

| Signal | Type | Name/Description |
|----------|------|---|
| APWRDISN | I | Auxiliary Power Disable Input. When this pin is active, it disables the device from using auxiliary power supply. |
| CCLKDS | I | Common Clock Downstream. The assertion of this pin indicates that all downstream ports are using the same clock source as that provided to downstream devices. This bit is used as the initial value of the Slot Clock Configuration bit in all of the Link Status Registers for downstream ports. The value may be override by modifying the SCLK bit in the downstream port's PCIELSTS register. |
| CCLKUS | I | Common Clock Upstream. The assertion of this pin indicates that the upstream port is using the same clock source as the upstream device. This bit is used as the initial value of the Slot Clock Configuration bit in the Link Status Register for the upstream port. The value may be overridden by modifying the SCLK bit in the PA_PCIEELSTS register. |
| PERSTN | I | Fundamental Reset. Assertion of this signal resets all logic inside the PES4T4 and initiates a PCI Express fundamental reset. |

Table 4 System Pins (Part 1 of 2)

| Signal | Type | Name/Description |
|-------------|------|--|
| RSTHALT | I | Reset Halt. When this signal is asserted during a PCI Express fundamental reset, the PES4T4 executes the reset procedure and remains in a reset state with the Master SMBus active. This allows software to read and write registers internal to the device before normal device operation begins. The device exits the reset state when the RSTHALT bit is cleared in the PA_SWCTL register by the SMBus master. |
| SWMODE[2:0] | I | Switch Mode. These configuration pins determine the PES4T4 switch operating mode. 0x0 - Normal switch mode 0x1 - Normal switch mode with Serial EEPROM initialization 0x2 - through 0xF Reserved |
| WAKEN | I/O | Wake Input/Output. The WAKEN signal is an input or output. The WAKEN signal input/output selection can be made through WAKEDIR bit setting in the WAKEUPCNTL register. |

Table 4 System Pins (Part 2 of 2)

| Signal | Type | Name/Description |
|-------------|------|--|
| JTAG_TCK | I | JTAG Clock. This is an input test clock used to clock the shifting of data into or out of the boundary scan logic or JTAG Controller. JTAG_TCK is independent of the system clock with a nominal 50% duty cycle. |
| JTAG_TDI | I | JTAG Data Input. This is the serial data input to the boundary scan logic or JTAG Controller. |
| JTAG_TDO | O | JTAG Data Output. This is the serial data shifted out from the boundary scan logic or JTAG Controller. When no data is being shifted out, this signal is tri-stated. |
| JTAG_TMS | I | JTAG Mode. The value on this signal controls the test mode select of the boundary scan logic or JTAG Controller. |
| JTAG_TRST_N | I | JTAG Reset. This active low signal asynchronously resets the boundary scan logic and JTAG TAP Controller. An external pull-up on the board is recommended to meet the JTAG specification in cases where the tester can access this signal. However, for systems running in functional mode, one of the following should occur: 1) actively drive this signal low with control logic 2) statically drive this signal low with an external pull-down on the board |

Table 5 Test Pins

| Signal | Type | Name/Description |
|----------------------|------|--|
| V _{DD} CORE | I | Core VDD. Power supply for core logic. |
| V _{DD} I/O | I | I/O VDD. LVTTTL I/O buffer power supply. |
| V _{DD} PE | I | PCI Express Digital Power. PCI Express digital power used by the digital power of the SerDes. |
| V _{DD} APE | I | PCI Express Analog Power. PCI Express analog power used by the PLL and bias generator. |
| V _{TT} PE | I | PCI Express Termination Power. |
| V _{SS} | I | Ground. |

Table 6 Power and Ground Pins

Pin Characteristics

Note: Some input pads of the PES4T4 do not contain internal pull-ups or pull-downs. Unused inputs should be tied off to appropriate levels. This is especially critical for unused control signal inputs which, if left floating, could adversely affect operation. Also, any input pin left floating can cause a slight increase in power consumption.

| Function | Pin Name | Type | Buffer | I/O Type | Internal Resistor | Notes |
|-----------------------|---------------|------|----------------|----------------------|-------------------|----------------------------------|
| PCI Express Interface | PE0RN[0] | I | CML | Serial Link | | |
| | PE0RP[0] | I | | | | |
| | PE0TN[0] | O | | | | |
| | PE0TP[0] | O | | | | |
| | PE2RN[0] | I | | | | |
| | PE2RP[0] | I | | | | |
| | PE2TN[0] | O | | | | |
| | PE2TP[0] | O | | | | |
| | PE3RN[0] | I | | | | |
| | PE3RP[0] | I | | | | |
| | PE3TN[0] | O | | | | |
| | PE3TP[0] | O | | | | |
| | PE4RN[0] | I | | | | |
| | PE4RP[0] | I | | | | |
| | PE4TN[0] | O | | | | |
| | PE4TP[0] | O | | | | |
| | PEREFCLKN | I | LVPECL/ CML | Diff. Clock Input | | Refer to Table 8 |
| | PEREFCLKP | I | | | | |
| SMBus | MSMBCLK | I/O | LVTTTL | STI ¹ | | |
| | MSMBDAT | I/O | | | | |
| General Purpose I/O | GPIO[9,7,2:0] | I/O | LVTTTL | High Drive | pull-up | |
| System Pins | APWRDISN | I | LVTTTL | Input | pull-down | |
| | CCLKDS | I | | | pull-up | |
| | CCLKUS | I | | | pull-up | |
| | PERSTN | I | | | | |
| | RSTHALT | I | | | pull-down | |
| | SWMODE[2:0] | I | | | pull-down | |
| | WAKEN | I/O | | | open-drain | |
| EJTAG / JTAG | JTAG_TCK | I | LVTTTL | STI | pull-up | |
| | JTAG_TDI | I | | STI | pull-up | |
| | JTAG_TDO | O | | | | |
| | JTAG_TMS | I | | STI | pull-up | |
| | JTAG_TRST_N | I | | STI | pull-up | |

Table 7 Pin Characteristics

¹. Schmitt Trigger Input (STI).

Logic Diagram — PES4T4

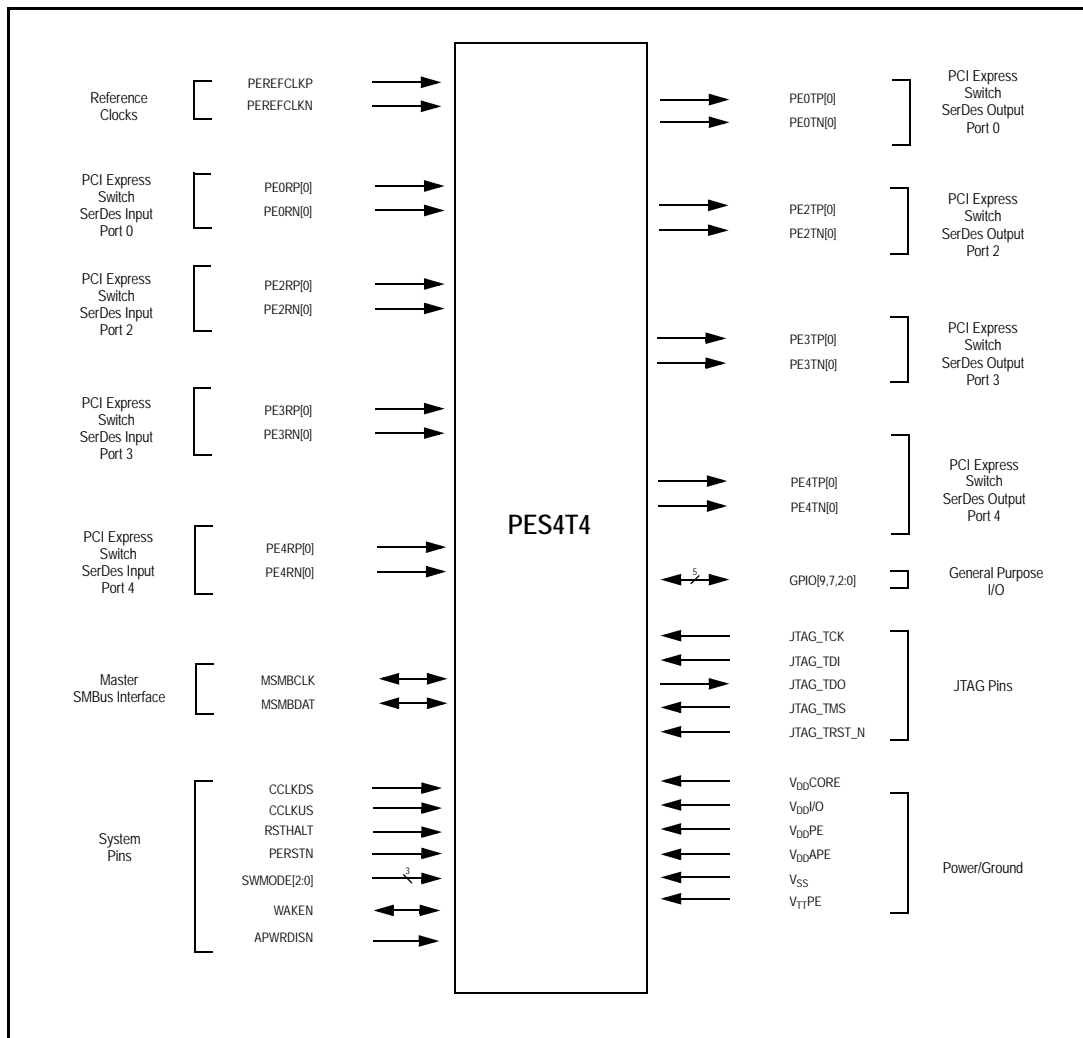

Figure 3 PES4T4 Logic Diagram

System Clock Parameters

Values based on systems running at recommended supply voltages and operating temperatures, as shown in Tables 12 and 13.

| Parameter | Description | Min | Typical | Max | Unit |
|-----------------------------------|---|-----|---------|----------|-------------------|
| PEREFCLK | | | | | |
| Refclk _{FREQ} | Input reference clock frequency range | 100 | | | MHz |
| Refclk _{DC} ¹ | Duty cycle of input clock | 40 | 50 | 60 | % |
| T _R , T _F | Rise/Fall time of input clocks | | | 0.2*RCUI | RCUI ² |
| V _{SW} | Differential input voltage swing ³ | 0.6 | | 1.6 | V |
| T _{jitter} | Input clock jitter (cycle-to-cycle) | | | 125 | ps |

Table 8 Input Clock Requirements

¹ ClkIn must be AC coupled. Use 0.01 — 0.1 μF ceramic capacitors.

² RCUI (Reference Clock Unit Interval) refers to the reference clock period.

³ AC coupling required.

AC Timing Characteristics

| Parameter | Description | Min ¹ | Typical ¹ | Max ¹ | Units |
|---|--|------------------|----------------------|------------------|-------|
| PCIe Transmit | | | | | |
| UI | Unit Interval | 399.88 | 400 | 400.12 | ps |
| T _{TX-EYE} | Minimum Tx Eye Width | 0.7 | .9 | | UI |
| T _{TX-EYE-MEDIAN-to-MAX-JITTER} | Maximum time between the jitter median and maximum deviation from the median | | | 0.15 | UI |
| T _{TX-RISE} , T _{TX-FALL} | D+ / D- Tx output rise/fall time | 50 | 90 | | ps |
| T _{TX-IDLE-MIN} | Minimum time in idle | 50 | | | UI |
| T _{TX-IDLE-SET-TO-IDLE} | Maximum time to transition to a valid Idle after sending an Idle ordered set | | | 20 | UI |
| T _{TX-IDLE-TO-DIFF-DATA} | Maximum time to transition from valid idle to diff data | | | 20 | UI |
| T _{TX-SKEW} | Transmitter data skew between any 2 lanes | | 500 | 1300 | ps |
| T _{BTE_n} | Time from asserting Beacon TxEn to beacon being transmitted on the lane | | 30 | 80 | ns |
| PCIe Receive | | | | | |
| UI | Unit Interval | 399.88 | 400 | 400.12 | ps |
| T _{RX-EYE (with jitter)} | Minimum Receiver Eye Width (jitter tolerance) | 0.4 | | | UI |

Table 9 PCIe AC Timing Characteristics (Part 1 of 2)

| Parameter | Description | Min ¹ | Typical ¹ | Max ¹ | Units |
|--|---|------------------|----------------------|------------------|-------|
| T _{RX-EYE-MEDIUM TO MAX JITTER} | Max time between jitter median & max deviation | | | 0.3 | UI |
| T _{RX-IDLE-DET-DIFF-ENTER TIME} | Unexpected Idle Enter Detect Threshold Integration Time | | | 10 | ms |
| T _{RX-SKEW} | Lane to lane input skew | | | 20 | ns |

Table 9 PCIe AC Timing Characteristics (Part 2 of 2)

¹: Minimum, Typical, and Maximum values meet the requirements under PCI Specification 1.1

| Signal | Symbol | Reference Edge | Min | Max | Unit | Timing Diagram Reference |
|----------------------------|----------------------|----------------|-----|-----|------|--------------------------|
| GPIO | | | | | | |
| GPIO[9,7,2:0] ¹ | Tpw_13b ² | None | 50 | — | ns | See Figure 4. |

Table 10 GPIO AC Timing Characteristics

¹: GPIO signals must meet the setup and hold times if they are synchronous or the minimum pulse width if they are asynchronous.

²: The values for this symbol were determined by calculation, not by testing.

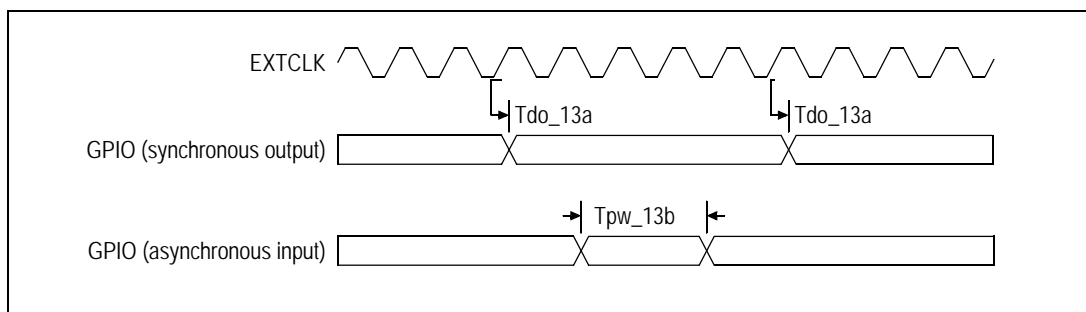

Figure 4 GPIO AC Timing Waveform

| Signal | Symbol | Reference Edge | Min | Max | Unit | Timing Diagram Reference |
|----------------------------------|----------------------|------------------|------|------|------|--------------------------|
| JTAG | | | | | | |
| JTAG_TCK | Tper_16a | none | 25.0 | 50.0 | ns | See Figure 5. |
| | Thigh_16a, Tlow_16a | | 10.0 | 25.0 | ns | |
| JTAG_TMS ¹ , JTAG_TDI | Tsu_16b | JTAG_TCK rising | 2.4 | — | ns | |
| | Thld_16b | | 1.0 | — | ns | |
| JTAG_TDO | Tdo_16c | JTAG_TCK falling | — | 11.3 | ns | |
| | Tdz_16c ² | | — | 11.3 | ns | |
| JTAG_TRST_N | Tpw_16d ² | none | 25.0 | — | ns | |

Table 11 JTAG AC Timing Characteristics

¹ The JTAG specification, IEEE 1149.1, recommends that JTAG_TMS should be held at 1 while the signal applied at JTAG_TRST_N changes from 0 to 1. Otherwise, a race may occur if JTAG_TRST_N is deasserted (going from low to high) on a rising edge of JTAG_TCK when JTAG_TMS is low, because the TAP controller might go to either the Run-Test/Idle state or stay in the Test-Logic-Reset state.

² The values for this symbol were determined by calculation, not by testing.

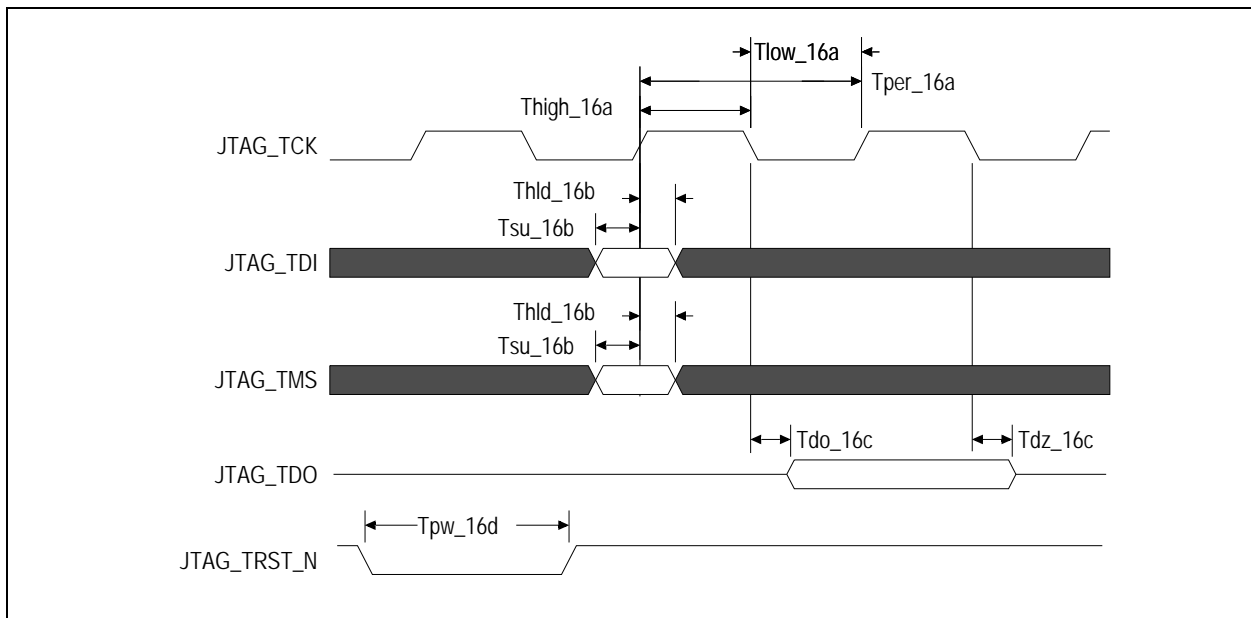

Figure 5 JTAG AC Timing Waveform

Recommended Operating Supply Voltages

| Symbol | Parameter | Minimum | Typical | Maximum | Unit |
|----------------------|--|---------|---------|---------|------|
| V _{DD} CORE | Internal logic supply | 0.9 | 1.0 | 1.1 | V |
| V _{DD} I/O | I/O supply except for SerDes LVPECL/CML | 3.135 | 3.3 | 3.465 | V |
| V _{DD} PE | PCI Express Digital Power | 0.9 | 1.0 | 1.1 | V |
| V _{DD} APE | PCI Express Analog Power | 0.9 | 1.0 | 1.1 | V |
| V _{TT} PE | PCI Express Serial Data Transmit Termination Voltage | 1.425 | 1.5 | 1.575 | V |
| V _{SS} | Common ground | 0 | 0 | 0 | V |

Table 12 PES4T4 Operating Voltages

Power-Up/Power-Down Sequence

This section describes the sequence in which various voltages must be applied to the part during power-up to ensure proper functionality. For the PES4T4, the power-up sequence must be as follows:

1. V_{DD}I/O — 3.3V
2. V_{DD}Core, V_{DD}PE, V_{DD}APE — 1.0V
3. V_{TT}PE — 1.5V

When powering up, each voltage level must ramp and stabilize prior to applying the next voltage in the sequence to ensure internal latch-up issues are avoided. There are no maximum time limitations in ramping to valid power levels.

The power-down sequence must be in the reverse order of the power-up sequence.

Recommended Operating Temperature

| Grade | Temperature |
|------------|------------------------|
| Commercial | 0°C to +70°C Ambient |
| Industrial | -40°C to +85°C Ambient |

Table 13 PES4T4 Operating Temperatures

Power Consumption

Typical power is measured under the following conditions: 25°C Ambient, 35% total link usage on all ports, typical voltages defined in [Table 12](#).

Maximum power is measured under the following conditions: 70°C Ambient, 85% total link usage on all ports, maximum voltages defined in [Table 12](#).

All power measurements assume that the part is mounted on a 10 layer printed circuit board with 0 LFM airflow.

| Number of Connected Lanes | | Core Supply | | PCIe Digital Supply | | PCIe Analog Supply | | PCIe Termination Supply | | I/O Supply | | Total | |
|---------------------------|--------------|-------------|----------|---------------------|----------|--------------------|----------|-------------------------|------------|------------|------------|-----------|-----------|
| | | Typ 1.0V | Max 1.1V | Typ 1.0V | Max 1.1V | Typ 1.0V | Max 1.1V | Typ 1.5V | Max 1.575V | Typ 3.3V | Max 3.465V | Typ Power | Max Power |
| 1/1/1/1 | mA | 270 | 363 | 218 | 279 | 110 | 130 | 101 | 125 | 3 | 3.3 | | |
| | Watts | 0.27 | 0.40 | 0.22 | 0.31 | 0.11 | 0.14 | 0.15 | 0.20 | 0.01 | 0.01 | 0.76 | 1.06 |

Table 14 PES4T4 Power Consumption

Thermal Considerations — Option A Package

This section describes thermal considerations for the PES4T4 (13mm² BCG144 package). The data in [Table 15](#) below contains information that is relevant to the thermal performance of the PES4T4 switch.

| Symbol | Parameter | Value | Units | Conditions |
|--------------------------|---|-------|-------|---------------------------------------|
| $T_{J(max)}$ | Junction Temperature | 125 | °C | Maximum |
| $T_{A(max)}$ | Ambient Temperature | 70 | °C | Maximum for commercial-rated products |
| $T_{A(max)}$ | Ambient Temperature | 85 | °C | Maximum for industrial-rated products |
| $\theta_{JA(effective)}$ | Effective Thermal Resistance, Junction-to-Ambient | 34.6 | °C/W | Zero air flow |
| | | 30.3 | °C/W | 1 m/S air flow |
| | | 28.4 | °C/W | 2 m/S air flow |
| θ_{JB} | Thermal Resistance, Junction-to-Board | 18.8 | °C/W | |
| θ_{JC} | Thermal Resistance, Junction-to-Case | 10 | °C/W | |
| P | Power Dissipation of the Device | 1.06 | Watts | Maximum |

Table 15 Thermal Specifications for PES4T4, 13x13mm BCG144 Package

Thermal Considerations — Option B Package

This section describes thermal considerations for the PES4T4 (10mm² NQG132 package). The data in [Table 16](#) below contains information that is relevant to the thermal performance of the PES4T4 switch.

| Symbol | Parameter | Value | Units | Conditions |
|--------------------------|---|-------|-------|---------------------------------------|
| $T_{J(max)}$ | Junction Temperature | 125 | °C | Maximum |
| $T_{A(max)}$ | Ambient Temperature | 70 | °C | Maximum for commercial-rated products |
| $\theta_{JA(effective)}$ | Effective Thermal Resistance, Junction-to-Ambient | 23.5 | °C/W | Zero air flow |
| | | 19.6 | °C/W | 1 m/S air flow |
| | | 17.4 | °C/W | 2 m/S air flow |
| θ_{JB} | Thermal Resistance, Junction-to-Board | 0.2 | °C/W | |
| θ_{JC} | Thermal Resistance, Junction-to-Case | 7.6 | °C/W | |
| P | Power Dissipation of the Device | 1.06 | Watts | Maximum |

Table 16 Thermal Specifications for PES4T4, 10x10mm NQG132 Package

DC Electrical Characteristics

Values based on systems running at recommended supply voltages, as shown in [Table 12](#).

Note: See [Table 7](#), Pin Characteristics, for a complete I/O listing.

| I/O Type | Parameter | Description | Min ¹ | Typ ¹ | Max ¹ | Unit | Conditions |
|---------------------------|---|---|------------------|------------------|------------------|----------|------------|
| Serial Link | PCIe Transmit | | | | | | |
| | $V_{TX-DIFFp-p}$ | Differential peak-to-peak output voltage | 800 | | 1200 | mV | |
| | $V_{TX-DE-RATIO}$ | De-emphasized differential output voltage | -3 | | -4 | dB | |
| | $V_{TX-DC-CM}$ | DC Common mode voltage | -0.1 | 1 | 3.7 | V | |
| | $V_{TX-CM-ACP}$ | RMS AC peak common mode output voltage | | | 20 | mV | |
| | $V_{TX-CM-DC-active-idle-delta}$ | Abs delta of DC common mode voltage between L0 and idle | | | 100 | mV | |
| | $V_{TX-CM-DC-line-delta}$ | Abs delta of DC common mode voltage between D+ and D- | | | 25 | mV | |
| | $V_{TX-Idle-DiffP}$ | Electrical idle diff peak output | | | 20 | mV | |
| | $V_{TX-RCV-Detect}$ | Voltage change during receiver detection | | | 600 | mV | |
| | $RL_{TX-DIFF}$ | Transmitter Differential Return loss | 10 | | | dB | |
| | RL_{TX-CM} | Transmitter Common Mode Return loss | 6 | | | dB | |
| | $Z_{TX-DEFF-DC}$ | DC Differential TX impedance | 80 | 100 | 120 | Ω | |
| | Z_{OSE} | Single ended TX Impedance | 40 | 50 | 60 | Ω | |
| | Transmitter Eye Diagram | TX Eye Height (De-emphasized bits) | 505 | 650 | | mV | |
| | Transmitter Eye Diagram | TX Eye Height (Transition bits) | 800 | 950 | | mV | |
| | PCIe Receive | | | | | | |
| | $V_{RX-DIFFp-p}$ | Differential input voltage (peak-to-peak) | 175 | | 1200 | mV | |
| | $V_{RX-CM-AC}$ | Receiver common-mode voltage for AC coupling | | | 150 | mV | |
| | $RL_{RX-DIFF}$ | Receiver Differential Return Loss | 10 | | | dB | |
| | RL_{RX-CM} | Receiver Common Mode Return Loss | 6 | | | dB | |
| | $Z_{RX-DIFF-DC}$ | Differential input impedance (DC) | 80 | 100 | 120 | Ω | |
| | $Z_{RX-COMM-DC}$ | Single-ended input impedance | 40 | 50 | 60 | Ω | |
| $Z_{RX-COMM-HIGH-Z-DC}$ | Powered down input common mode impedance (DC) | 200k | 350k | | Ω | | |
| $V_{RX-IDLE-DET-DIFFp-p}$ | Electrical idle detect threshold | 65 | | 175 | mV | | |
| PCIe REFCLK | | | | | | | |
| | C_{IN} | Input Capacitance | 1.5 | — | | pF | |

Table 17 DC Electrical Characteristics (Part 1 of 2)

| I/O Type | Parameter | Description | Min ¹ | Typ ¹ | Max ¹ | Unit | Conditions |
|-----------------------------|----------------------------------|-------------|------------------|------------------|------------------|---------|------------------|
| Other I/Os | | | | | | | |
| LOW Drive Output | I_{OL} | | — | 2.5 | — | mA | $V_{OL} = 0.4V$ |
| | I_{OH} | | — | -5.5 | — | mA | $V_{OH} = 1.5V$ |
| High Drive Output | I_{OL} | | — | 12.0 | — | mA | $V_{OL} = 0.4V$ |
| | I_{OH} | | — | -20.0 | — | mA | $V_{OH} = 1.5V$ |
| Schmitt Trigger Input (STI) | V_{IL} | | -0.3 | — | 0.8 | V | — |
| | V_{IH} | | 2.0 | — | $V_{DD}/O + 0.5$ | V | — |
| Input | V_{IL} | | -0.3 | — | 0.8 | V | — |
| | V_{IH} | | 2.0 | — | $V_{DD}/O + 0.5$ | V | — |
| Capacitance | C_{IN} | | — | — | 8.5 | pF | — |
| Leakage | Inputs | | — | — | ± 10 | μA | V_{DD}/O (max) |
| | I/O_{LEAK} w/o Pull-ups/downs | | — | — | ± 10 | μA | V_{DD}/O (max) |
| | I/O_{LEAK} WITH Pull-ups/downs | | — | — | ± 80 | μA | V_{DD}/O (max) |

Table 17 DC Electrical Characteristics (Part 2 of 2)

¹: Minimum, Typical, and Maximum values meet the requirements under PCI Specification 1.1.

Option A Package Pinout — 144-BGA Signal Pinout for PES4T4

The following table lists the pin numbers and signal names for the PES4T4 144-pin device.

| Pin | Function | Alt | Pin | Function | Alt | Pin | Function | Alt | Pin | Function | Alt |
|-----|----------------------|-----|-----|----------------------|-----|-----|----------------------|-----|-----|----------------------|-----|
| A1 | V _{SS} | | C11 | V _{DD} CORE | | F9 | V _{DD} CORE | | J7 | V _{SS} | |
| A2 | V _{DD} I/O | | C12 | V _{SS} | | F10 | V _{DD} I/O | | J8 | V _{DD} CORE | |
| A3 | APWRDISN | | D1 | JTAG_TDO | | F11 | V _{DD} I/O | | J9 | V _{SS} | |
| A4 | V _{TT} PE | | D2 | MSMBCLK | | F12 | GPIO_01 | 1 | J10 | V _{SS} | |
| A5 | V _{TT} PE | | D3 | V _{DD} CORE | | G1 | V _{SS} | | J11 | V _{DD} I/O | |
| A6 | PE0TP00 | | D4 | V _{SS} | | G2 | JTAG_TRST_N | | J12 | GPIO_09 | 1 |
| A7 | V _{DD} PE | | D5 | V _{SS} | | G3 | V _{SS} | | K1 | V _{SS} | |
| A8 | PE0RP00 | | D6 | V _{SS} | | G4 | V _{DD} CORE | | K2 | V _{DD} CORE | |
| A9 | V _{DD} I/O | | D7 | V _{DD} CORE | | G5 | V _{SS} | | K3 | V _{DD} I/O | |
| A10 | SWMODE_0 | | D8 | V _{SS} | | G6 | V _{DD} CORE | | K4 | V _{DD} CORE | |
| A11 | SWMODE_1 | | D9 | V _{SS} | | G7 | V _{SS} | | K5 | V _{DD} PE | |
| A12 | V _{SS} | | D10 | V _{SS} | | G8 | V _{DD} CORE | | K6 | V _{SS} | |
| B1 | V _{DD} CORE | | D11 | PERSTN | | G9 | V _{SS} | | K7 | V _{DD} PE | |
| B2 | WAKEN | | D12 | RSTHALT | | G10 | V _{DD} CORE | | K8 | V _{SS} | |
| B3 | CCLKUS | | E1 | JTAG_TDI | | G11 | V _{SS} | | K9 | V _{DD} CORE | |
| B4 | V _{DD} PE | | E2 | MSMBDAT | | G12 | GPIO_02 | 1 | K10 | V _{DD} I/O | |
| B5 | V _{DD} PE | | E3 | V _{DD} I/O | | H1 | PEREFCLKP | | K11 | V _{SS} | |
| B6 | PE0TN00 | | E4 | V _{DD} CORE | | H2 | V _{DD} I/O | | K12 | V _{SS} | |
| B7 | V _{DD} PE | | E5 | V _{SS} | | H3 | V _{DD} APE | | L1 | PE2RN00 | |
| B8 | PE0RN00 | | E6 | V _{DD} CORE | | H4 | V _{SS} | | L2 | V _{SS} | |
| B9 | CCLKDS | | E7 | V _{SS} | | H5 | V _{SS} | | L3 | PE2TP00 | |
| B10 | SWMODE_2 | | E8 | V _{SS} | | H6 | V _{SS} | | L4 | V _{SS} | |
| B11 | V _{SS} | | E9 | V _{SS} | | H7 | V _{DD} CORE | | L5 | PE3TN00 | |
| B12 | V _{SS} | | E10 | V _{DD} CORE | | H8 | V _{SS} | | L6 | V _{DD} APE | |
| C1 | JTAG_TMS | | E11 | V _{SS} | | H9 | V _{SS} | | L7 | PE3RN00 | |
| C2 | V _{SS} | | E12 | GPIO_00 | 1 | H10 | V _{DD} CORE | | L8 | V _{TT} PE | |
| C3 | V _{SS} | | F1 | JTAG_TCK | | H11 | V _{SS} | | L9 | PE4RP00 | |
| C4 | V _{DD} CORE | | F2 | V _{DD} I/O | | H12 | GPIO_07 | 1 | L10 | V _{SS} | |
| C5 | V _{DD} APE | | F3 | V _{DD} CORE | | J1 | PEREFCLKN | | L11 | PE4TN00 | |
| C6 | V _{DD} APE | | F4 | V _{SS} | | J2 | V _{SS} | | L12 | V _{DD} CORE | |
| C7 | V _{SS} | | F5 | V _{DD} CORE | | J3 | V _{SS} | | M1 | PE2RP00 | |
| C8 | V _{DD} CORE | | F6 | V _{SS} | | J4 | V _{SS} | | M2 | V _{SS} | |
| C9 | V _{DD} CORE | | F7 | V _{DD} CORE | | J5 | V _{SS} | | M3 | PE2TN00 | |
| C10 | V _{SS} | | F8 | V _{SS} | | J6 | V _{DD} CORE | | M4 | V _{TT} PE | |

Table 18 PES4T4 144-pin Signal Pin-Out (Part 1 of 2)

| Pin | Function | Alt | Pin | Function | Alt | Pin | Function | Alt | Pin | Function | Alt |
|-----|-----------------|-----|-----|---------------------|-----|-----|-----------------|-----|-----|-----------------|-----|
| M5 | PE3TP00 | | M7 | PE3RP00 | | M9 | PE4RN00 | | M11 | PE4TP00 | |
| M6 | V _{SS} | | M8 | V _{DD} APE | | M10 | V _{SS} | | M12 | V _{SS} | |

Table 18 PES4T4 144-pin Signal Pin-Out (Part 2 of 2)

Package A Alternate Signal Functions

| Pin | GPIO | Alternate |
|-----|---------|------------|
| E12 | GPIO_00 | P2RSTN |
| F12 | GPIO_01 | P4RSTN |
| G12 | GPIO_02 | IOEXPINTN0 |
| H12 | GPIO_07 | GPEN |
| J12 | GPIO_09 | P3RSTN |

Table 19 PES4T4 144-pin Alternate Signal Functions

Package A Power Pins

| V _{DD} Core | V _{DD} Core | V _{DD} I/O | V _{DD} PE | V _{DD} APE | V _{TT} PE |
|----------------------|----------------------|---------------------|--------------------|---------------------|--------------------|
| B1 | F9 | A2 | A7 | C5 | A4 |
| C4 | G4 | A9 | B4 | C6 | A5 |
| C8 | G6 | E3 | B5 | H3 | L8 |
| C9 | G8 | F2 | B7 | L6 | M4 |
| C11 | G10 | F10 | K5 | M8 | |
| D3 | H7 | F11 | K7 | | |
| D7 | H10 | H2 | | | |
| E4 | J6 | J11 | | | |
| E6 | J8 | K3 | | | |
| E10 | K2 | K10 | | | |
| F3 | K4 | | | | |
| F5 | K9 | | | | |
| F7 | L12 | | | | |

Table 20 PES4T4 144-pin Power Pins

Package A Ground Pins

| V _{SS} | V _{SS} | V _{SS} | V _{SS} |
|-----------------|-----------------|-----------------|-----------------|
| A1 | D10 | G11 | K1 |
| A12 | E5 | H4 | K6 |
| B11 | E7 | H5 | K8 |
| B12 | E8 | H6 | K11 |
| C2 | E9 | H8 | K12 |
| C3 | E11 | H9 | L2 |
| C7 | F4 | H11 | L4 |
| C10 | F6 | J2 | L10 |
| C12 | F8 | J3 | M2 |
| D4 | G1 | J4 | M6 |
| D5 | G3 | J5 | M10 |
| D6 | G5 | J7 | M12 |
| D8 | G7 | J9 | |
| D9 | G9 | J10 | |

Table 21 PES4T4 144-pin Ground Pins

Package A Pin Signals Listed Alphabetically

| Signal Name | I/O Type | Location | Signal Category |
|-------------|----------|----------|------------------------------|
| APWRDISN | I | A3 | System |
| CCLKDS | I | B9 | |
| CCLKUS | I | B3 | |
| GPIO_00 | I/O | E12 | General Purpose Input/Output |
| GPIO_01 | I/O | F12 | |
| GPIO_02 | I/O | G12 | |
| GPIO_07 | I/O | H12 | |
| GPIO_09 | I/O | J12 | |
| JTAG_TCK | I | F1 | JTAG |
| JTAG_TDI | I | E1 | |
| JTAG_TDO | I | D1 | |
| JTAG-TMS | O | C1 | |
| JTAG-TRST_N | I | G2 | |
| MSMBCLK | I/O | D2 | SMBus |
| MSMBDAT | I/O | E2 | |

Table 22 89PES4T4 144-pin Alphabetical Signal List (Part 1 of 2)

| Signal Name | I/O Type | Location | Signal Category |
|--|--|----------|-----------------|
| PE0RN00 | I | B8 | PCI Express |
| PE0RP00 | I | A8 | |
| PE0TN00 | O | B6 | |
| PE0TP00 | O | A6 | |
| PE2RN00 | I | L1 | |
| PE2RP00 | I | M1 | |
| PE2TN00 | O | M3 | |
| PE2TP00 | O | L3 | |
| PE3RN00 | I | L7 | |
| PE3RP00 | I | M7 | |
| PE3TN00 | O | L5 | |
| PE3TP00 | O | M5 | |
| PE4RN00 | I | M9 | |
| PE4RP00 | I | L9 | |
| PE4TN00 | O | L11 | |
| PE4TP00 | O | M11 | |
| PEREFCLKN | I | J1 | |
| PEREFCLKP | I | H1 | |
| PERSTN | I | D11 | |
| RSTHALT | I | D12 | |
| SWMODE_0 | I | A10 | |
| SWMODE_1 | I | A11 | |
| SWMODE_2 | I | B10 | |
| WAKEN | I/O | B2 | |
| $V_{DD}CORE$, $V_{DD}APE$, $V_{DD}I/O$, $V_{DD}PE$, $V_{TT}PE$ | See Table 20 for a listing of power pins. | | |
| V_{SS} | See Table 21 for a listing of ground pins. | | |

Table 22 89PES4T4 144-pin Alphabetical Signal List (Part 2 of 2)

Package A Pinout — Top View

| | | | | | | | | | | | | | |
|---|---|---|---|---|---|---|---|---|---|----|----|----|---|
| | 1 | 2 | 3 | 4 | 5 | 6 | 7 | 8 | 9 | 10 | 11 | 12 | |
| A | | | | | | | | | | | | | A |
| B | | | | | | | | | | | | | B |
| C | | | | | | | | | | | | | C |
| D | | | | | | | | | | | | | D |
| E | | | | | | | | | | | | | E |
| F | | | | | | | | | | | | | F |
| G | | | | | | | | | | | | | G |
| H | | | | | | | | | | | | | H |
| J | | | | | | | | | | | | | J |
| K | | | | | | | | | | | | | K |
| L | | | | | | | | | | | | | L |
| M | | | | | | | | | | | | | M |
| | 1 | 2 | 3 | 4 | 5 | 6 | 7 | 8 | 9 | 10 | 11 | 12 | |

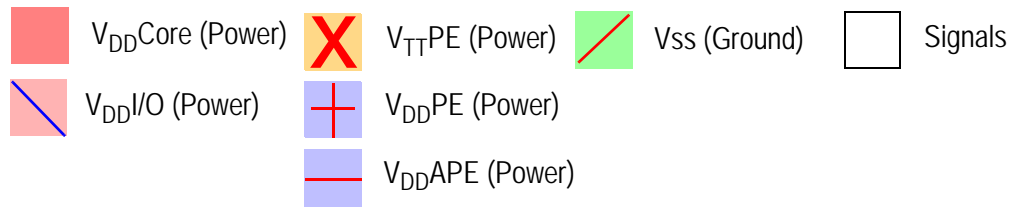

Package A Package Drawing — 144-Pin BC144/BCG144

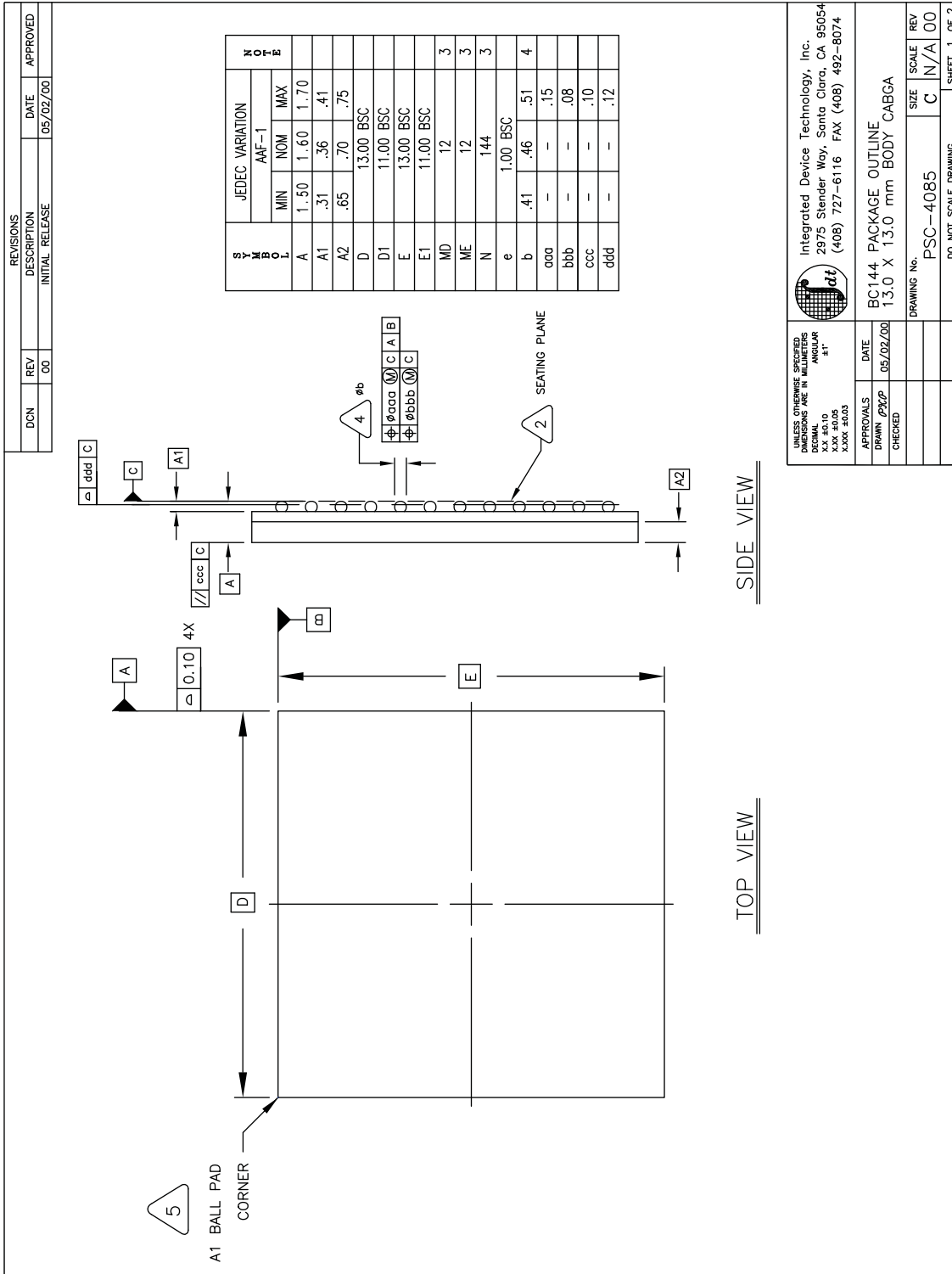

Package A Package Drawing — Page Two

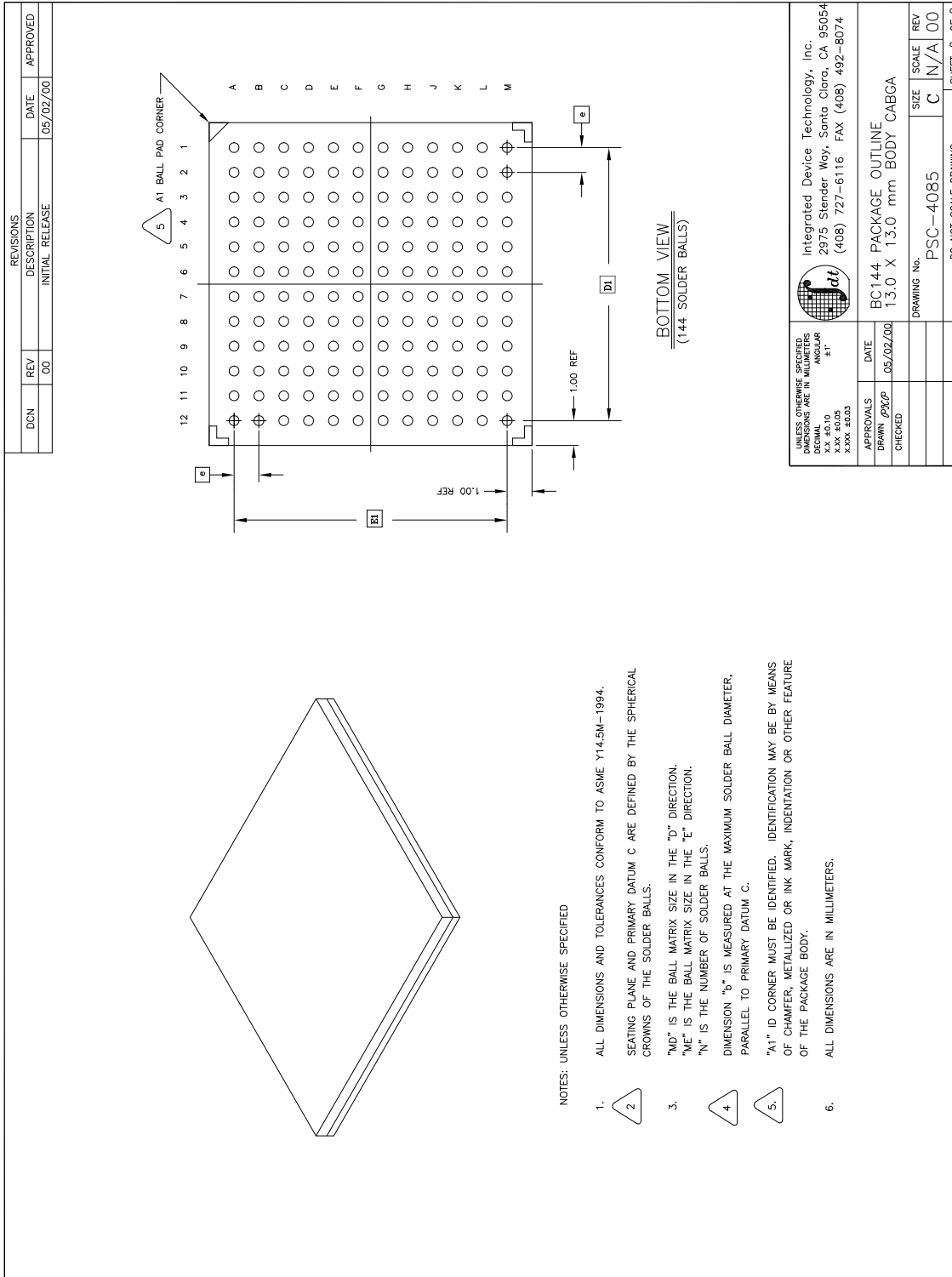

| | | | |
|---|----------|--|--------------|
| UNLESS OTHERWISE SPECIFIED DIMENSIONS ARE IN MILLIMETERS | | Integrated Device Technology, Inc. 2975 Stender Way, Santa Clara, CA 95054 (408) 727-6116 FAX (408) 492-8074 | |
| X.XX ±0.10 | ANGULAR | | |
| X.XXX ±0.05 | 5° | | |
| X.XXX ±0.03 | | BC144 PACKAGE OUTLINE 13.0 X 13.0 mm BODY CABGA | |
| APPROVALS | DATE | DRAWING No. | SIZE |
| DRWN PZP | 05/02/00 | PSC-4085 | C |
| CHECKED | | | N/A |
| | | SCALE | REV |
| | | | 00 |
| DO NOT SCALE DRAWING | | | SHEET 2 OF 2 |

Package B Package Pinout — 132-QFN Signal Pinout for PES4T4

The following table lists the pin numbers and signal names for the PES4T4 132-pin device.

| Pin | Function | Alt | Pin | Function | Alt | Pin | Function | Alt | Pin | Function | Alt |
|-----|----------------------|-----|-----|----------------------|-----|-----|----------------------|-----|-----|----------------------|-----|
| A1 | NC | | A34 | V _{DD} CORE | | A67 | V _{DD} PE | | B28 | V _{DD} PE | |
| A2 | NC | | A35 | NC | | A68 | V _{DD} CORE | | B29 | V _{DD} PE | |
| A3 | V _{DD} I/O | | A36 | NC | | A69 | V _{DD} I/O | | B30 | V _{DD} CORE | |
| A4 | V _{DD} I/O | | A37 | NC | | A70 | WAKEN | | B31 | V _{DD} CORE | |
| A5 | V _{DD} CORE | | A38 | NC | | A71 | NC | | B32 | V _{SS} | |
| A6 | V _{DD} CORE | | A39 | GPIO_09 | 1 | A72 | NC | | B33 | V _{DD} CORE | |
| A7 | MSMBDAT | | A40 | V _{DD} CORE | | B1 | V _{SS} | | B34 | V _{SS} | |
| A8 | MSMBCLK | | A41 | V _{DD} CORE | | B2 | V _{SS} | | B35 | V _{DD} I/O | |
| A9 | V _{SS} | | A42 | GPIO_07 | 1 | B3 | V _{DD} I/O | | B36 | V _{SS} | |
| A10 | JTAG_TRST_N | | A43 | V _{SS} | | B4 | V _{SS} | | B37 | V _{DD} CORE | |
| A11 | JTAG_TMS | | A44 | NC | | B5 | V _{DD} CORE | | B38 | V _{DD} I/O | |
| A12 | JTAG_TDO | | A45 | NC | | B6 | V _{SS} | | B39 | V _{DD} CORE | |
| A13 | JTAG_TDI | | A46 | V _{SS} | | B7 | V _{SS} | | B40 | V _{DD} CORE | |
| A14 | JTAG_TCK | | A47 | V _{DD} I/O | | B8 | V _{DD} CORE | | B41 | V _{DD} I/O | |
| A15 | PEREFCLKP | | A48 | GPIO_02 | 1 | B9 | V _{DD} I/O | | B42 | V _{DD} CORE | |
| A16 | PEREFCLKN | | A49 | GPIO_01 | 1 | B10 | V _{DD} CORE | | B43 | V _{SS} | |
| A17 | NC | | A50 | GPIO_00 | 1 | B11 | V _{SS} | | B44 | RSTHALT | |
| A18 | NC | | A51 | V _{DD} I/O | | B12 | V _{DD} CORE | | B45 | PERSTN | |
| A19 | NC | | A52 | V _{DD} CORE | | B13 | V _{SS} | | B46 | SWMODE_2 | |
| A20 | NC | | A53 | NC | | B14 | V _{DD} APE | | B47 | V _{SS} | |
| A21 | V _{DD} CORE | | A54 | NC | | B15 | V _{SS} | | B48 | V _{DD} CORE | |
| A22 | PE2RP00 | | A55 | NC | | B16 | V _{DD} I/O | | B49 | CCLKDS | |
| A23 | PE2TP00 | | A56 | NC | | B17 | PE2RN00 | | B50 | V _{SS} | |
| A24 | PE2TN00 | | A57 | SWMODE_1 | | B18 | V _{SS} | | B51 | V _{DD} PE | |
| A25 | PE3TN00 | | A58 | SWMODE_0 | | B19 | V _{DD} PE | | B52 | V _{DD} PE | |
| A26 | PE3TP00 | | A59 | V _{DD} I/O | | B20 | V _{TT} PE | | B53 | V _{TT} PE | |
| A27 | PE3RP00 | | A60 | PE0RN00 | | B21 | V _{DD} PE | | B54 | V _{DD} APE | |
| A28 | PE3RN00 | | A61 | PE0RP00 | | B22 | V _{SS} | | B55 | V _{DD} APE | |
| A29 | V _{DD} APE | | A62 | PE0TP00 | | B23 | V _{SS} | | B56 | V _{DD} APE | |
| A30 | PE4RN00 | | A63 | PE0TN00 | | B24 | V _{DD} APE | | B57 | V _{SS} | |
| A31 | PE4RP00 | | A64 | V _{DD} PE | | B25 | V _{SS} | | B58 | APWRDISN | |
| A32 | PE4TP00 | | A65 | V _{DD} APE | | B26 | V _{SS} | | B59 | V _{DD} CORE | |
| A33 | PE4TN00 | | A66 | V _{DD} APE | | B27 | V _{TT} PE | | B60 | CCLKUS | |

Table 23 PES4T4 132-pin Signal Pin-Out

Package B Alternate Signal Functions

| Pin | GPIO | Alternate |
|-----|---------|------------|
| A50 | GPIO_00 | P2RSTN |
| A49 | GPIO_01 | P4RSTN |
| A48 | GPIO_02 | IOEXPINTN0 |
| A42 | GPIO_07 | GPEN |
| A39 | GPIO_09 | P3RSTN |

Table 24 PES4T4 132-pin Alternate Signal Functions

Package B Power Pins

| V _{DD} Core | V _{DD} Core | V _{DD} I/O | V _{DD} PE | V _{DD} APE | V _{TT} PE |
|----------------------|----------------------|---------------------|--------------------|---------------------|--------------------|
| A5 | B12 | A3 | A64 | A29 | B20 |
| A6 | B30 | A4 | A67 | A65 | B27 |
| A21 | B31 | A47 | B19 | A66 | B53 |
| A34 | B33 | A51 | B21 | B14 | |
| A40 | B37 | A59 | B28 | B24 | |
| A41 | B39 | A69 | B29 | B54 | |
| A52 | B40 | B3 | B51 | B55 | |
| A68 | B42 | B9 | B52 | B56 | |
| B5 | B48 | B16 | | | |
| B8 | B59 | B35 | | | |
| B10 | — | B38 | | | |
| | | B41 | | | |

Table 25 PES4T4 132-pin Power Pins

Package B Ground Pins

| V _{SS} | V _{SS} | V _{SS} | V _{SS} |
|-----------------|-----------------|-----------------|-----------------|
| A9 | B6 | B22 | B36 |
| A43 | B7 | B23 | B43 |
| A46 | B11 | B25 | B47 |
| B1 | B13 | B26 | B50 |
| B2 | B15 | B32 | B57 |
| B4 | B18 | B34 | — |

Table 26 PES4T4 132-pin Ground Pins

Package B No Connection Pins

| NC | NC |
|-----|-----|
| A1 | A38 |
| A2 | A44 |
| A17 | A45 |
| A18 | A53 |
| A19 | A54 |
| A20 | A55 |
| A35 | A56 |
| A36 | A71 |
| A37 | A72 |

Table 27 PES4T4 132-pin No Connection Pins

Package B Pin Signals Listed Alphabetically

| Signal Name | I/O Type | Location | Signal Category |
|-------------|----------|----------|------------------------------|
| APWRDISN | I | B58 | System |
| CCLKDS | I | B49 | |
| CCLKUS | I | B60 | |
| GPIO_00 | I/O | A50 | General Purpose Input/Output |
| GPIO_01 | I/O | A49 | |
| GPIO_02 | I/O | A48 | |
| GPIO_07 | I/O | A42 | |
| GPIO_09 | I/O | A39 | |

Table 28 89PES4T4 132-pin Alphabetical Signal List (Part 1 of 2)

| Signal Name | I/O Type | Location | Signal Category | |
|--|---|----------|-----------------|--------|
| JTAG_TCK | I | A14 | JTAG | |
| JTAG_TDI | I | A13 | | |
| JTAG_TDO | I | A12 | | |
| JTAG-TMS | O | A11 | | |
| JTAG-TRST_N | I | A10 | | |
| MSMBCLK | I/O | A8 | SMBus | |
| MSMBDAT | I/O | A7 | | |
| NC | See Table 27 for a listing of no connection pins. | | | |
| PE0RN00 | I | A60 | PCI Express | |
| PE0RP00 | I | A61 | | |
| PE0TN00 | O | A63 | | |
| PE0TP00 | O | A62 | | |
| PE2RN00 | I | B17 | | |
| PE2RP00 | I | A22 | | |
| PE2TN00 | O | A24 | | |
| PE2TP00 | O | A23 | | |
| PE3RN00 | I | A28 | | |
| PE3RP00 | I | A27 | | |
| PE3TN00 | O | A25 | | |
| PE3TP00 | O | A26 | | |
| PE4RN00 | I | A30 | | |
| PE4RP00 | I | A31 | | |
| PE4TN00 | O | A33 | | |
| PE4TP00 | O | A32 | | |
| PEREFCLKN | I | A16 | | |
| PEREFCLKP | I | A15 | | |
| PERSTN | I | B45 | | System |
| RSTHALT | I | B44 | | |
| SWMODE_0 | I | A58 | | |
| SWMODE_1 | I | A57 | | |
| SWMODE_2 | I | B46 | | |
| WAKEN | I/O | A70 | | |
| V _{DD} CORE, V _{DD} APE, V _{DD} I/O, V _{DD} PE, V _{TT} PE | See Table 25 for a listing of power pins. | | | |
| V _{SS} | See Table 26 for a listing of ground pins. | | | |

Table 28 89PES4T4 132-pin Alphabetical Signal List (Part 2 of 2)

Package B Pinout — Top View

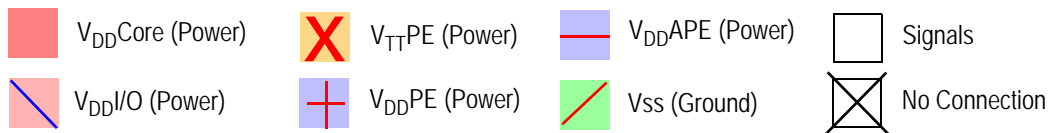
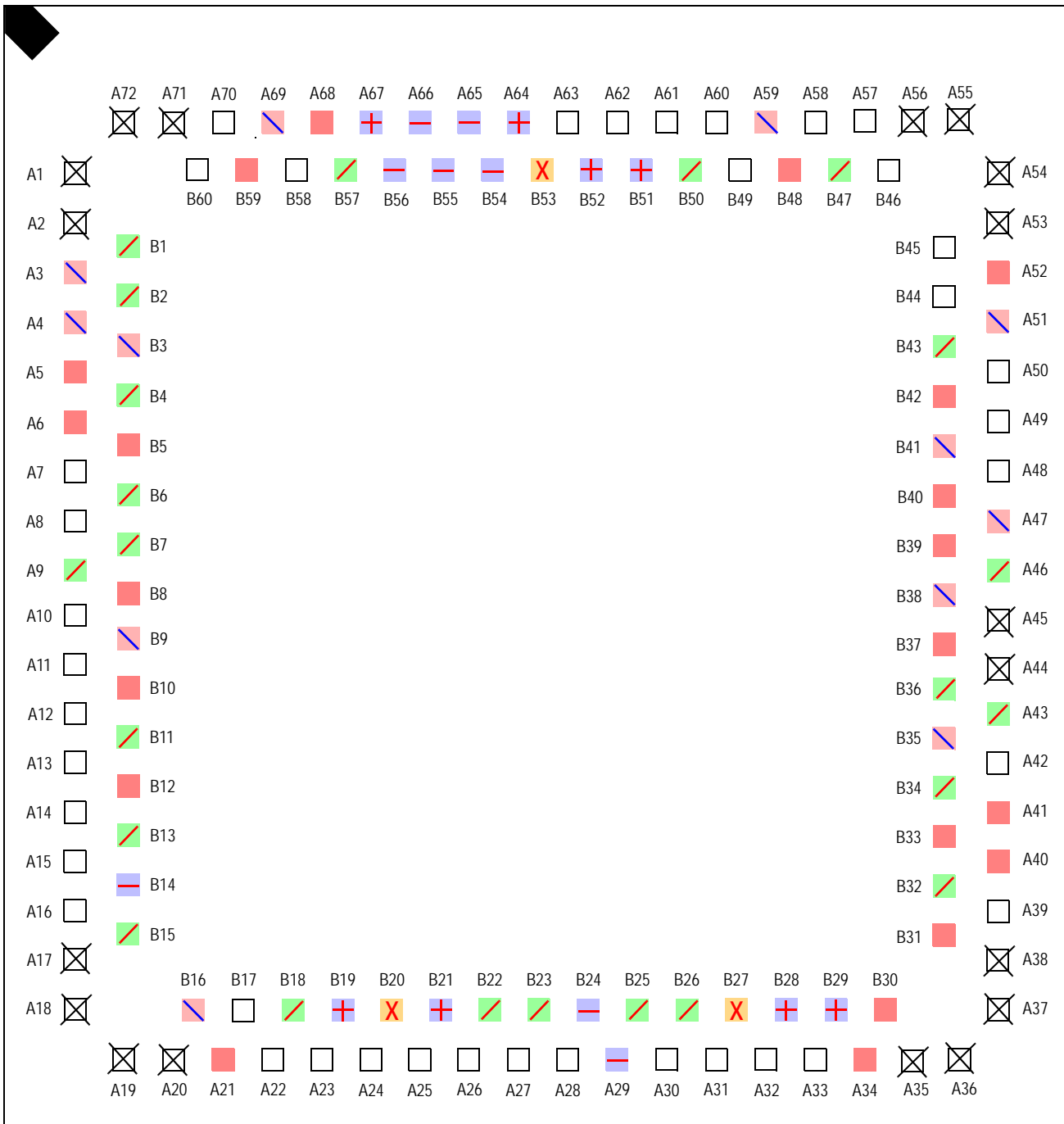

| REVISIONS | | | |
|-----------|-----|-----------------|----------|
| DCN | REV | DESCRIPTION | DATE |
| | 00 | INITIAL RELEASE | 07/10/07 |
| | | | DP |

NOTES:

- DIE THICKNESS ALLOWABLE IS 0.305mm MAXIMUM(.012 INCHES MAXIMUM)
- DIMENSIONING & TOLERANCES CONFORM TO ASME Y14.5M. - 1994.
- N IS THE NUMBER OF TERMINALS.
- NDa, NDb ARE THE NUMBER OF TERMINALS IN X-DIRECTION & NEG, NEB ARE THE NUMBER OF TERMINALS IN Y-DIRECTION.
- DIMENSION b APPLIES TO PLATED TERMINAL AND IS MEASURED BETWEEN 0.15 AND 0.30mm FROM TERMINAL TIP.
- THE PIN #1 IDENTIFIER MUST BE EXISTED ON THE TOP SURFACE OF THE PACKAGE BY USING INDENTATION MARK OR OTHER FEATURE OF PACKAGE BODY.
- EXACT SHAPE AND SIZE OF THIS FEATURE IS OPTIONAL.
- ALL DIMENSIONS ARE IN MILLIMETERS.
- UNILATERAL COPLANARITY ZONE APPLIES TO THE EXPOSED PAD AS WELL AS THE TERMINALS.
- APPLIED ONLY FOR TERMINALS.

<STANDARD>

10. DIMENSIONS OF D2 & E2 : 6.5mm x 6.5mm

| COMMON DIMENSIONS | | | |
|-------------------|-----------|------|------|
| | MIN | NOM | MAX |
| A | 0.80 | 0.85 | 0.90 |
| A1 | 0.00 | 0.01 | 0.05 |
| A2 | 0.55 | 0.60 | 0.65 |
| A3 | 0.25 REF. | | |
| D | 10.00 BSC | | |
| D1 | 9.73 BSC | | |
| E | 10.00 BSC | | |
| E1 | 9.73 BSC | | |

| PITCH VARIATION | | | |
|-----------------|----------|------|------|
| | MIN | NOM | MAX |
| MIN | 0.50 | | |
| MAX | 0.65 | | |
| N | 132 | | 3 |
| NDa | 18 | | 3 |
| NDb | 15 | | 3 |
| NEG | 18 | | 3 |
| NEB | 15 | | 3 |
| Lg | 0.30 | 0.40 | 0.50 |
| Lb | 0.30 | 0.40 | 0.50 |
| b | 0.17 | 0.22 | 0.27 |
| D2 | SEE NOTE | | |
| E2 | SEE NOTE | | |
| θ | 12° | | |
| P | 0.24 | 0.42 | 0.60 |

GENERAL : NOMINAL EXPOSED PAD(D2/E2) DIMENSION = NOMINAL DIE ATTACH PAD DIMENSION-0.20

SIDE ATTACH PAD X-SECTION VIEW

| TOLERANCES UNLESS SPECIFIED | |
|-----------------------------|----------------------------------|
| LINEAR | ANGULAR |
| XXX± | XXX± |
| WWW.IDT.COM | |
| APPROVALS | DATE |
| DRAWN: SUP | 07/10/07 |
| CHECKED | TITLE |
| C | NO/NOG132 PACKAGE OUTLINE |
| SIZE | 10.0 x 10.0 mm BODY Dual-Row QFN |
| DRAWING No. | 0.50/0.65mm Pitch PUNCH Type |
| REV | REV |
| PSC-4215 | 00 |

6024 Silver Creek Valley Road
San Jose, CA 95138
PHONE: (408) 284-8200
FAX: (408) 284-8591

IDTTM

DO NOT SCALE DRAWING

SHEET 2 OF 2

Revision History

March 31, 2008: Publication of final data sheet.

June 4, 2008: For the 132-QFN package, changed pins A44 and A45 from GPIO to No Connect and changed pin B6 from V_{DDCORE} to V_{SS} .

August 6, 2008: Added industrial temperature information to Tables 13 and 15 and to Ordering Information section. Revised Package B Pinout Top View graphic to match page 3 of the Package B drawing.

May 7, 2009: Revised labels in Table 14, Power Consumption, for greater clarification.

October 8, 2010: Added package height data to Note 10 on Page Two of Package B drawing and removed page 3 of Package B drawing.

January 25, 2011: In Table 8, deleted reference to 125MHz as max value for $Refclk_{FREQ}$.

June 12, 2014: Changed symbol A in [Package A Package Drawing — 144-Pin BC144/BCG144](#) to match the package characteristics of the part. The new definition for the symbol is 1.50 minimum, 1.60 nominal, and 1.70 maximum.

Ordering Information

| Product Family | Operating Voltage | Device Family | Product Detail | Device Revision | Package | Temp Range | |
|----------------|-------------------|---------------|----------------|-----------------|---------|------------|-------|
| | | | | | | | Blank |
| | | | | | | | I |
| | | | | | | | BC |
| | | | | | | | BCG |
| | | | | | | | NQ |
| | | | | | | | NOG |
| | | | | | | | ZB |
| | | | | | | | 4T4 |
| | | | | | | | PES |
| | | | | | | | H |
| | | | | | | | 89 |

Legend
 A = Alpha Character
 N = Numeric Character

Commercial Temperature (0°C to +70°C Ambient)
 Industrial Temperature (-40° C to +85° C Ambient)
 BC144 144-ball CABGA
 BCG144 144-ball CABGA, Green
 NQ132 132-ball QFN
 NOG132 132-ball QFN, Green
 ZB revision
 4-lane, 4-port
 PCI Express Switch
 1.0V +/- 0.1V Core Voltage
 Serial Switching Product

Valid Combinations

Option A Package

- 89HPES4T4ZBBC 144-pin BC144 package, Commercial Temperature
- 89HPES4T4ZBBCG 144-pin Green BC144 package, Commercial Temperature
- 89HPES4T4ZBCCI 144-pin BC144 package, Industrial Temperature
- 89HPES4T4ZBCCGI 144-pin Green BC144 package, Industrial Temperature

Option B Package

- 89HPES4T4ZBNQ 132-pin NQ132 package, Commercial Temperature
- 89HPES4T4ZBNQG 132-pin Green NQ132 package, Commercial Temperature



CORPORATE HEADQUARTERS
 6024 Silver Creek Valley Road
 San Jose, CA 95138

for SALES:
 800-345-7015 or 408-284-8200
 fax: 408-284-2775
www.idt.com

for Tech Support:
 email: ssdhelp@idt.com
 phone: 408-284-8208

Компания «Life Electronics» занимается поставками электронных компонентов импортного и отечественного производства от производителей и со складов крупных дистрибьюторов Европы, Америки и Азии.

С конца 2013 года компания активно расширяет линейку поставок компонентов по направлению коаксиальный кабель, кварцевые генераторы и конденсаторы (керамические, пленочные, электролитические), за счёт заключения дистрибьюторских договоров

Мы предлагаем:

- Конкурентоспособные цены и скидки постоянным клиентам.
- Специальные условия для постоянных клиентов.
- Подбор аналогов.
- Поставку компонентов в любых объемах, удовлетворяющих вашим потребностям.
- Приемлемые сроки поставки, возможна ускоренная поставка.
- Доставку товара в любую точку России и стран СНГ.
- Комплексную поставку.
- Работу по проектам и поставку образцов.
- Формирование склада под заказчика.
- Сертификаты соответствия на поставляемую продукцию (по желанию клиента).
- Тестирование поставляемой продукции.
- Поставку компонентов, требующих военную и космическую приемку.
- Входной контроль качества.
- Наличие сертификата ISO.

В составе нашей компании организован Конструкторский отдел, призванный помогать разработчикам, и инженерам.

Конструкторский отдел помогает осуществить:

- Регистрацию проекта у производителя компонентов.
- Техническую поддержку проекта.
- Защиту от снятия компонента с производства.
- Оценку стоимости проекта по компонентам.
- Изготовление тестовой платы монтаж и пусконаладочные работы.



Тел: +7 (812) 336 43 04 (многоканальный)

Email: org@lifeelectronics.ru