



High-voltage contactor

Gas-filled contactor for high-voltage DC switching

Series/Type: HVC200A-24
Ordering code: B88269X1010C011
Date: 2018-04-27
Version: 05

© EPCOS AG 2018. Reproduction, publication and dissemination of this publication, enclosures hereto and the information contained therein without EPCOS' prior express consent is prohibited.

EPCOS AG is a TDK Group Company.

Product description

The HVC series has been especially designed to meet the requirements of high-voltage DC switching applications. The optimized hermetically sealed design exhibits excellent reliability performance against harsh environments. HVC series can be used in a wide range of applications.

Features

- Gas-filled and hermetically sealed
- No EMI, no inrush current phase at start-up
- No polarity of contact terminals
- RoHS compatible

Applications

- Battery charge/ discharge systems
- Renewable energy storage systems
- DC high-voltage/ high-current applications
- DC fast charging stations

Characteristics

Height x width x depth	94 x 89 x 44	mm
Weight	~ 500	g
Inner contact material	Cu alloy	
Contact arrangement	1A	
Internal contact gap (full disconnection)	3.0 (2 x 1.5)	mm
Recommended connection cable cross section ^{a)}	> 50	mm ²
Coil wires		
- length	300	mm
- cross section	0.5	mm ²
- material	Cu	
Vibration in xyz-axis		
- shock, 11 ms ½ sine, peak	20	g
- vibration, sine 100 ... 2000 Hz, peak	20	g
- wideband random vibration, 10 ... 1000 Hz ^{b)}	5	g _{eff}
Operation and storage ^{c)}		
- temperature	-40 ... +85	°C
- humidity	5 ... 85	%
- air pressure	69 ... 106	kPa
Climatic category (IEC 60068-1)	40/085/21	
Label, black positive	 <div style="display: flex; justify-content: space-between; margin-top: 5px;"> <div style="font-size: small;"> [type name] [ordering code] [ser.no.] [internal code] [certifications] </div> </div>	
Certifications	UL 60947-4-1 (E491412)	

Notes

- ^{a)} The diameter must be matched to actual current and operation temperature (see: Cautions and warnings, page 7).
^{b)} Acc. to IEC 60068-2-64
^{c)} Freezing or condensing must be avoided.

Specification

Contact		
Maximum operating voltage	900	V _{DC}
Continuous operating current	200	A
Temporary overcurrent (10 min)	300	A
Temporary overcurrent (1 min)	400	A
Mechanical life time ¹⁾	1 000 000	switchings
Minimum make and break current	1	A
Maximum cut-off current (1 operation) ^{2) 3) 4)}	2000	A
Contact resistance typical (> 100 A)	< 0.4	mΩ
Insulation resistance at 1000 V (initial) contact to contact / contact to coil	> 1	GΩ
Dielectric strength contact to contact / contact to coil ⁵⁾	> 3800	V _{AC}
Operating time		
make	< 35	ms
break	< 15	ms
Coil		
Nominal voltage	24	V _{DC}
Operating voltage range	18 ... 32	V _{DC}
Pick-up voltage (max.)	18	V _{DC}
Drop-out voltage (min.)	2	V _{DC}
Power at nominal voltage ⁶⁾	6	W
Nominal resistance	96	Ω
Minimum holding current	80	mA

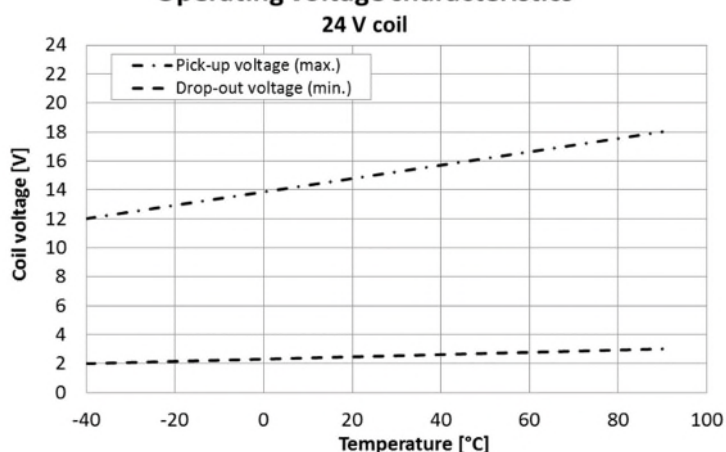
Operating voltage characteristics

Notes:

- ¹⁾ Duty cycle 50%, cycle duration 1 s, value represents B10 life time acc. to Weibull analysis.
- ²⁾ Specified according to JIS C 5442 (temperature 15 °C to 35 °C, humidity 25% to 85% RH).
- ³⁾ Tested at 450 V for resistive loads including inductance L < 35 μH.
End of life is reached when insulation resistance is < 50 MΩ at 1000 V.
- ⁴⁾ No fire and no explosion will occur after this break. Afterwards, the dielectric strength and insulation resistance may not meet initial data sheet specification.
- ⁵⁾ Detection limit 10 mA
- ⁶⁾ Tolerance ±10% at thermal equilibrium

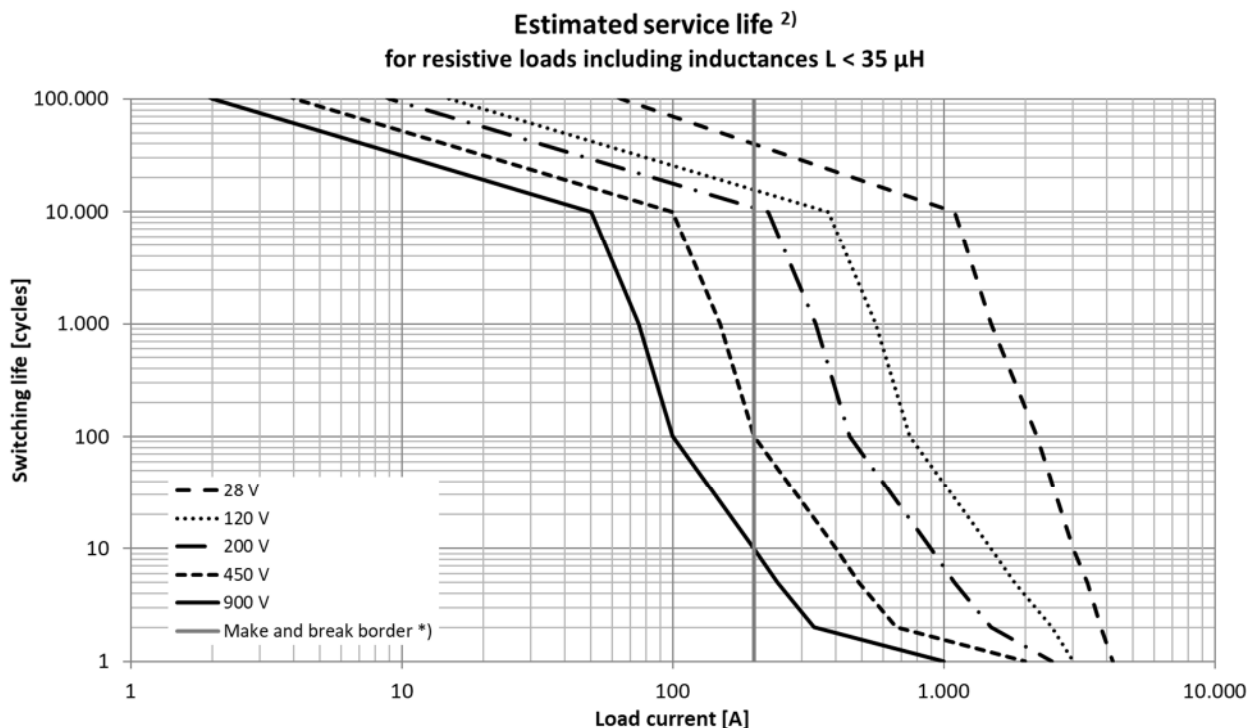
Characteristics



*) For currents > “make and break border” only break is permitted to avoid tack welding, duty cycle 1%, 600 s cycle duration.
For currents < “make and break border” make and break is permitted duty cycle 10%, 10 s cycle duration.

Current handling capability
at 85 °C

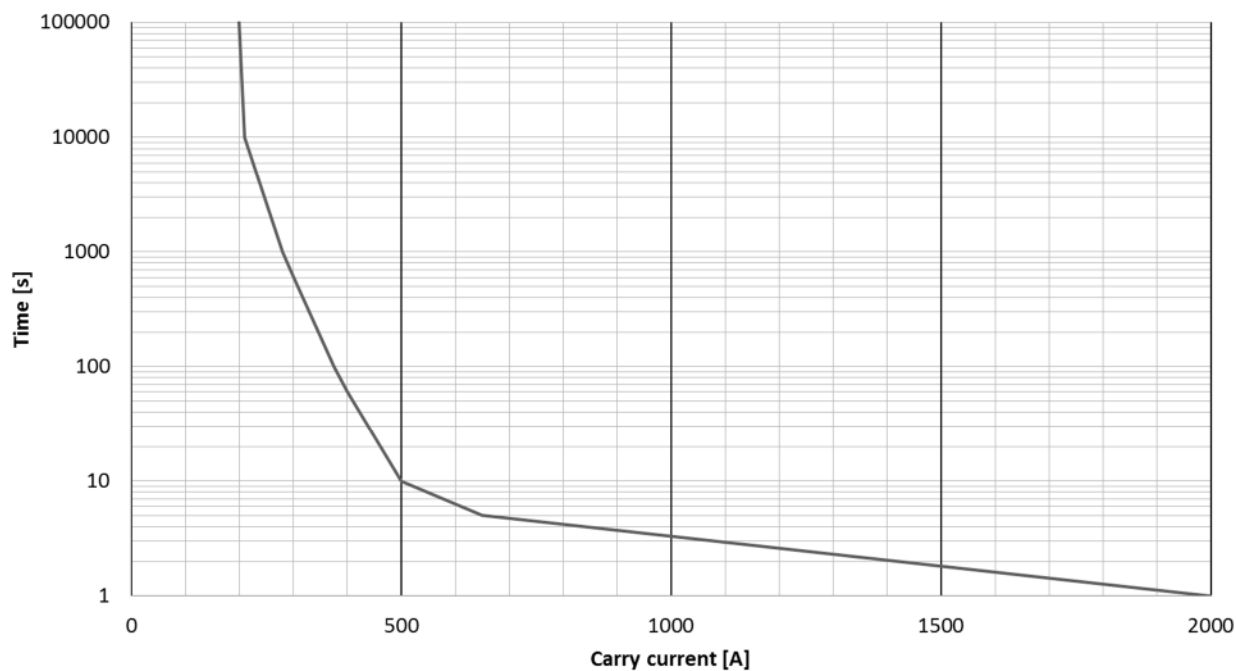

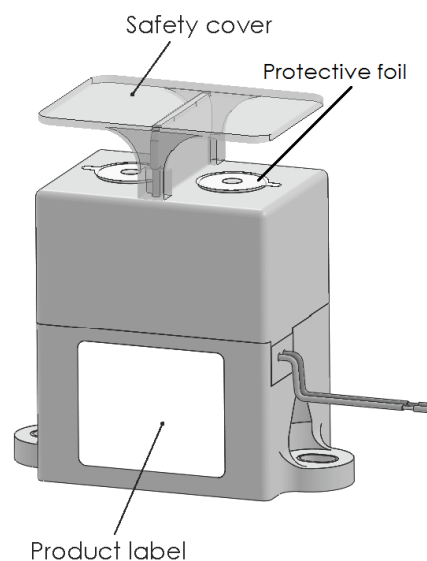
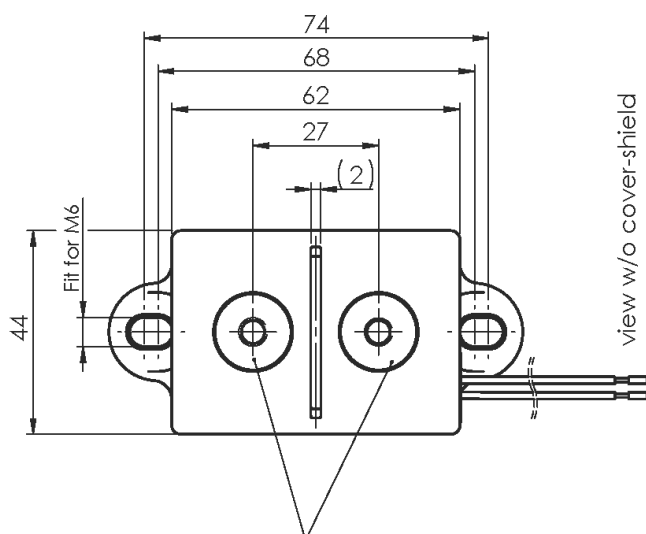
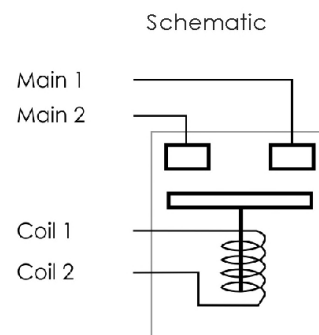
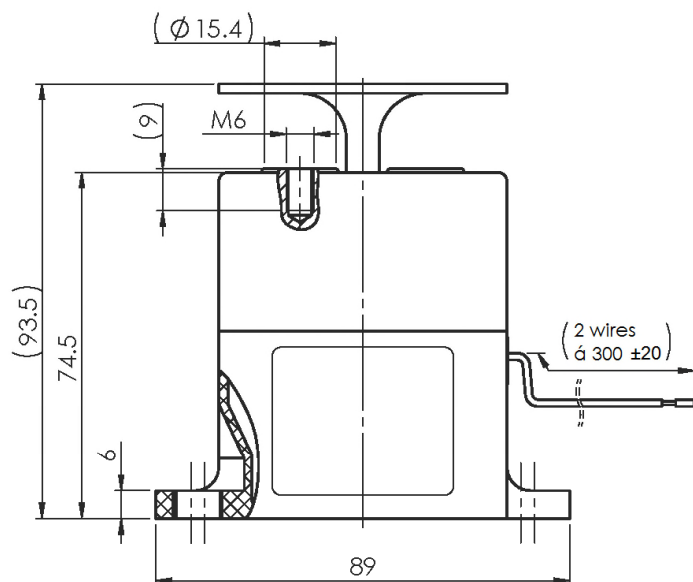
Dimensional drawings in mm

load input terminals - no polarity

General tolerances:

less than 10 : ±0.3

10 ... 50 : ±0.6

more than 50 : ±1

The cover over the main contacts is optional. It can be removed and reapplied if needed.

Note:

Before use, remove protective foil from main contact

Tightening torque of main contacts:

6 ... 8 Nm for M6 screw

Connection name	Marking
Main 1 terminal	none
Main 2 terminal	none
Coil 1 wire (+)	red
Coil 2 wire (-)	black

Packing unit

B88269X1010C 11 = 1 pc. in cardboard box



Cautions and warnings

- Contactors radiate magnetic and electromagnetic fields. Please ensure that other components mounted in close proximity are not affected.
- In case two contactors are mounted in close proximity a clearance distance of 20 mm has to be kept.
- The operating life of the contactor can be affected by strong magnetic fields. Please ensure that there are no magnetic field sources in close proximity.
- The contactor must be mounted so that the contact face side is perpendicular to the direction of the main shock-axis. If this is not possible, the contactor must be mounted upright.
- In order to ensure safe operation, the voltage at the connection terminals of the contactor must not exceed the nominal operating voltage by more than 10% in the event of a break under load.
- For continuous high current operation make sure that the connection terminals will not exceed temperatures of 120 °C by selecting an appropriate connection cable cross section or active cooling.
- This contactor is tested and classified acc. to UL as an open-type device. This means the contactor is intended to be installed in an ultimate enclosure provided by a 3rd party.
- The coil contacts need to be protected from overvoltage when switching off. Preferably a varistor should be installed in parallel. The overvoltage protection device which is used in parallel to the coil has an influence on the break time. Use of the EPCOS S07K75 varistor (or equivalent) is recommended.
- The leads to the contactor must be securely tightened to the terminals (check torque specification in data sheet), otherwise current stress may generate sparks and heating.
- The contactor must not be operated without any load, as this may increase the contact resistance.
- Contactors may become hot during extended periods of current overload (burn hazard).
- Contactors may be used only within their specified values. Overloading the contactor may destroy the component.
- Contactors must be handled with care and must not be dropped.
- Damaged contactors must not be re-used.
- For successful pick-up, the voltage cannot be ramped up slowly. The voltage needs to be applied instantly to at least the maximum pick-up voltage.
- The cover over the main contacts is optional. It can be snapped in place after attaching wires or bus bars to the main contacts to prevent accidental touching during assembly or maintenance. The cover can be removed and reinserted.

Display of ordering codes for EPCOS products

The ordering code for one and the same EPCOS product can be represented differently in data sheets, data books, other publications, on the EPCOS website, or in order-related documents such as shipping notes, order confirmations and product labels. **The varying representations of the ordering codes are due to different processes employed and do not affect the specifications of the respective products.** Detailed information can be found on the Internet under www.epcos.com/orderingcodes

Important notes

The following applies to all products named in this publication:

1. Some parts of this publication contain **statements about the suitability of our products for certain areas of application**. These statements are based on our knowledge of typical requirements that are often placed on our products in the areas of application concerned. We nevertheless expressly point out **that such statements cannot be regarded as binding statements about the suitability of our products for a particular customer application**. As a rule we are either unfamiliar with individual customer applications or less familiar with them than the customers themselves. For these reasons, it is always ultimately incumbent on the customer to check and decide whether a product with the properties described in the product specification is suitable for use in a particular customer application.
2. We also point out that **in individual cases, a malfunction of electronic components or failure before the end of their usual service life cannot be completely ruled out in the current state of the art, even if they are operated as specified**. In customer applications requiring a very high level of operational safety and especially in customer applications in which the malfunction or failure of an electronic component could endanger human life or health (e.g. in accident prevention or life-saving systems), it must therefore be ensured by means of suitable design of the customer application or other action taken by the customer (e.g. installation of protective circuitry or redundancy) that no injury or damage is sustained by third parties in the event of malfunction or failure of an electronic component.
3. **The warnings, cautions and product-specific notes must be observed.**
4. In order to satisfy certain technical requirements, **some of the products described in this publication may contain substances subject to restrictions in certain jurisdictions (e.g. because they are classed as hazardous)**. Useful information on this will be found in our Material Data Sheets on the Internet (www.tdk-electronics.tdk.com/material). Should you have any more detailed questions, please contact our sales offices.
5. We constantly strive to improve our products. Consequently, **the products described in this publication may change from time to time**. The same is true of the corresponding product specifications. Please check therefore to what extent product descriptions and specifications contained in this publication are still applicable before or when you place an order.

We also **reserve the right to discontinue production and delivery of products**. Consequently, we cannot guarantee that all products named in this publication will always be available. The aforementioned does not apply in the case of individual agreements deviating from the foregoing for customer-specific products.
6. Unless otherwise agreed in individual contracts, **all orders are subject to our General Terms and Conditions of Supply**.
7. **Our manufacturing sites serving the automotive business apply the IATF 16949 standard**. The IATF certifications confirm our compliance with requirements regarding the quality management system in the automotive industry. Referring to customer requirements and customer specific requirements ("CSR") TDK always has and will continue to have the policy of respecting individual agreements. Even if IATF 16949 may appear to support the acceptance of unilateral requirements, we hereby like to emphasize that **only requirements mutually agreed upon can and will be implemented in our Quality Management System**. For clarification purposes we like to point out that obligations from IATF 16949 shall only become legally binding if individually agreed upon.
8. The trade names EPCOS, CeraCharge, CeraDiode, CeraLink, CeraPad, CeraPlas, CSMP, CTVS, DeltaCap, DigiSiMic, ExoCore, FilterCap, FormFit, LeaXield, MiniBlue, MiniCell, MKD, MKK, MotorCap, PCC, PhaseCap, PhaseCube, PhaseMod, PhiCap, PowerHap, PQSine, PQvar, SIFERRIT, SIFI, SIKOREL, SilverCap, SIMDAD, SiMic, SIMID, SineFormer, SIOV, ThermoFuse, WindCap are **trademarks registered or pending** in Europe and in other countries. Further information will be found on the Internet at www.tdk-electronics.tdk.com/trademarks.

Release 2018-10

Mouser Electronics

Authorized Distributor

Click to View Pricing, Inventory, Delivery & Lifecycle Information:

[TDK:](#)

[B88269X1010C011](#)

Компания «Life Electronics» занимается поставками электронных компонентов импортного и отечественного производства от производителей и со складов крупных дистрибьюторов Европы, Америки и Азии.

С конца 2013 года компания активно расширяет линейку поставок компонентов по направлению коаксиальный кабель, кварцевые генераторы и конденсаторы (керамические, пленочные, электролитические), за счёт заключения дистрибьюторских договоров

Мы предлагаем:

- Конкурентоспособные цены и скидки постоянным клиентам.
- Специальные условия для постоянных клиентов.
- Подбор аналогов.
- Поставку компонентов в любых объемах, удовлетворяющих вашим потребностям.
- Приемлемые сроки поставки, возможна ускоренная поставка.
- Доставку товара в любую точку России и стран СНГ.
- Комплексную поставку.
- Работу по проектам и поставку образцов.
- Формирование склада под заказчика.
- Сертификаты соответствия на поставляемую продукцию (по желанию клиента).
- Тестирование поставляемой продукции.
- Поставку компонентов, требующих военную и космическую приемку.
- Входной контроль качества.
- Наличие сертификата ISO.

В составе нашей компании организован Конструкторский отдел, призванный помогать разработчикам, и инженерам.

Конструкторский отдел помогает осуществить:

- Регистрацию проекта у производителя компонентов.
- Техническую поддержку проекта.
- Защиту от снятия компонента с производства.
- Оценку стоимости проекта по компонентам.
- Изготовление тестовой платы монтаж и пусконаладочные работы.



Тел: +7 (812) 336 43 04 (многоканальный)
Email: org@lifeelectronics.ru