

SF2378E

**925.2 MHz
SAW Filter**

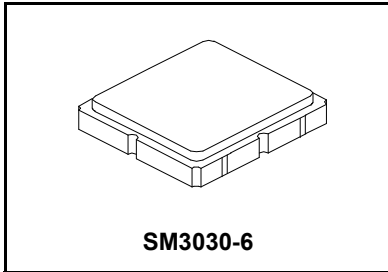

- **RF Filter for Mobile Communication Applications**
- **Low Insertion Loss**
- **3.0 x 3.0 x 1.3 mm Surface-Mount Case**

Absolute Maximum Ratings

Rating	Value	Units
Maximum Incident Power in Passband	+15	dBm
Maximum DC Voltage Between any 2 Terminals	3	VDC
Operating Temperature Range	-30 to +85	°C
Storage Temperature Range	-40 to +85	°C
Terminating Source Impedance (single) Z_S	50	Ω
Terminating Load Impedance (single) Z_L	50	Ω
Maximum Soldering Profile	260 °C for 10 s	

Characteristic	Sym	Notes	Min	Typ	Max	Units
Center Frequency	f_C			925.2		MHz
Minimum Insertion Loss, 922.3 - 928.1 MHz	IL			2.5	3.5	dB
Amplitude Ripple, 922.3 - 928.1 MHz				0.6	1.5	dB
VSWR						
Input (922.3 - 928.1 MHz)				1.4	2.0	
Output (922.3 - 928.1 MHz)				1.4	2.0	
Attenuation Referenced to 0 dB:						
10 to 815 MHz			42	45		dB
815 to 875 MHz			40	45		
875 to 905 MHz			35	40		
905 to 915 MHz			11	15		
945 to 950 MHz			35	40		
950 to 1150 MHz			50	55		
1150 to 1856 MHz			32	35		
1856 to 2500 MHz			32	35		

Case Style	SM3030-6 3 x 3 mm Nominal Footprint
Lid Symbolization (Y=year, WW=week, S=shift)	6F <u>Y</u> <u>WW</u> <u>S</u>

 **CAUTION: Electrostatic Sensitive Device. Observe precautions for handling.**

NOTES:

1. Unless noted otherwise, all specifications apply over the operating temperature range with filter soldered to the specified demonstration board with impedance matching to 50 Ω and measured with 50 Ω network analyzer.
2. Unless noted otherwise, all frequency specifications are referenced to the nominal center frequency, f_C .
3. Rejection is measured as attenuation below the minimum IL point in the passband. Rejection in final user application is dependent on PCB layout and external impedance matching design. See Application Note No. 42 for details.
4. "LRIP" or "L" after the part number indicates "low rate initial production" and "ENG" or "E" indicates "engineering prototypes."
5. The design, manufacturing process, and specifications of this filter are subject to change.
6. Either Port 1 or Port 2 may be used for either input or output in the design. However, impedances and impedance matching may vary between Port 1 and Port 2, so that the filter must always be installed in one direction per the circuit design.
7. US and international patents may apply.
8. Murata, stylized Murata logo, and Murata N.A., Inc. are registered trademarks of Murata Manufacturing Co., Ltd.
9. Electrostatic Sensitive Device. Observe precautions for handling.

Electrical Connections

Connection	Terminals
Input	2
Output	5
Ground	All others

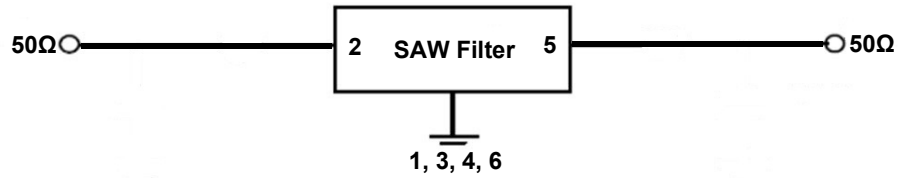

Frequency Characteristics

S21 Response: Span 200 MHz

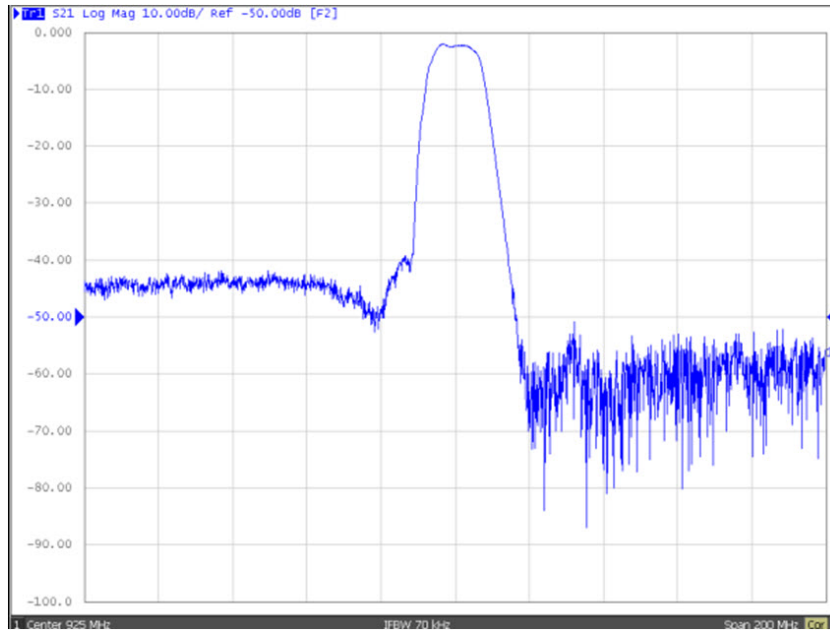

S21 Response: Span 5 MHz

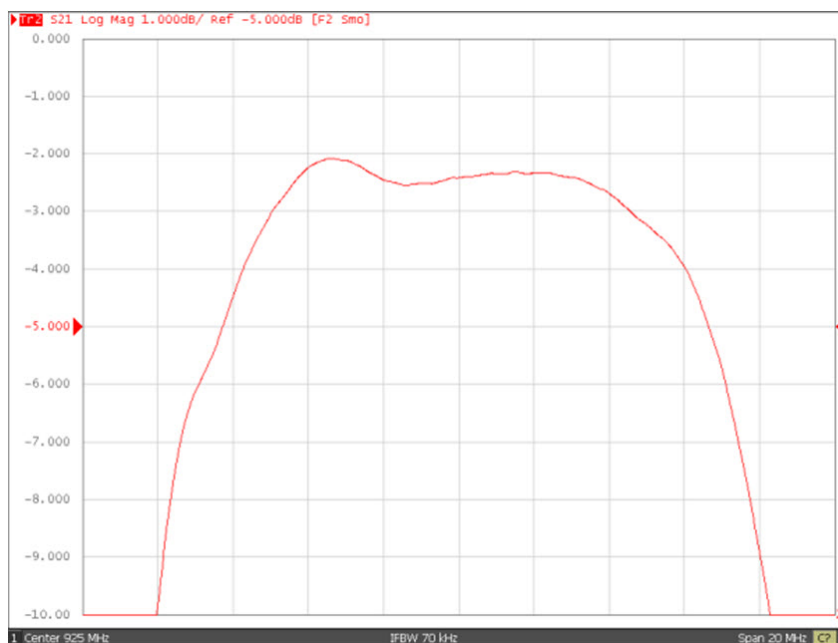

S21 Response: Span 5 MHz

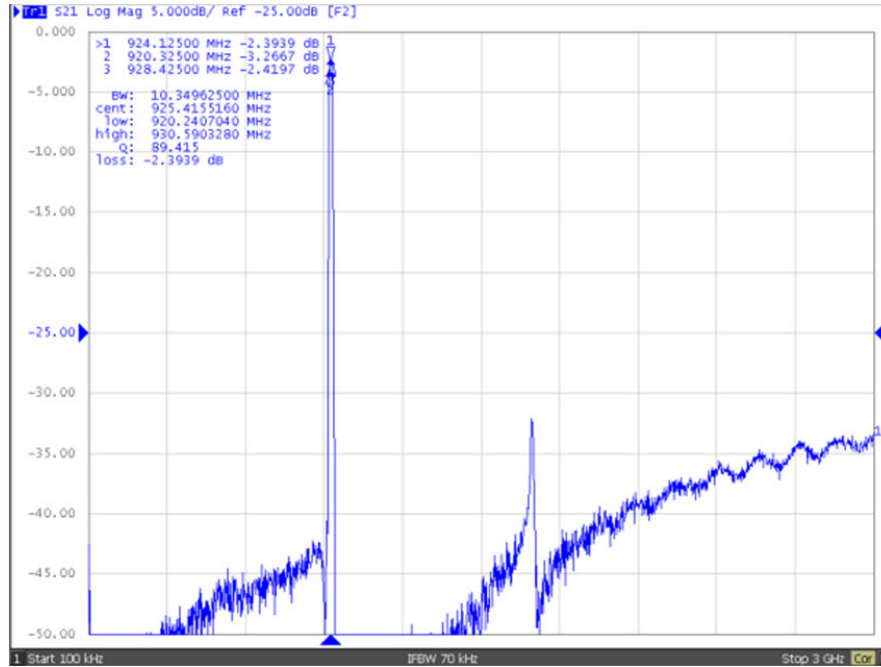

S21 Response: Span 5 MHz

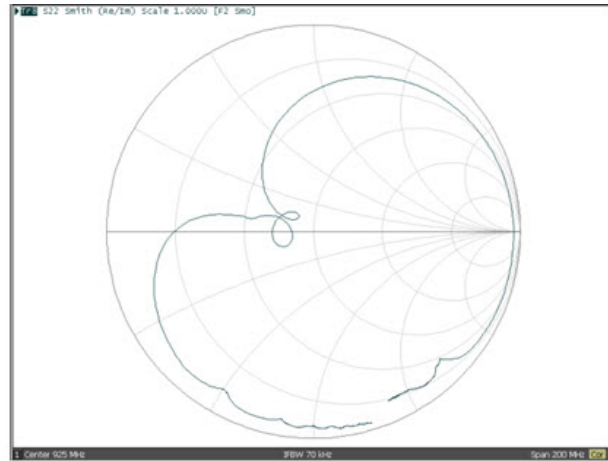
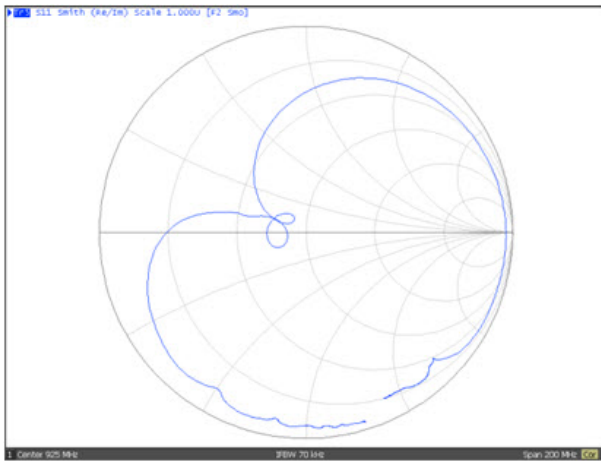

SM3030-6 Case

6-Terminal Ceramic Surface-Mount Case 3.0 X 3.0 mm Nominal Footprint

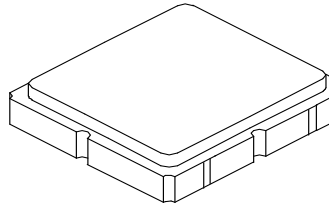

PCB Footprint, Top View

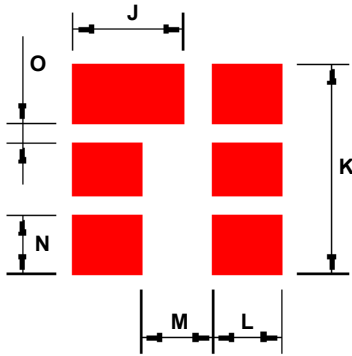

TOP VIEW

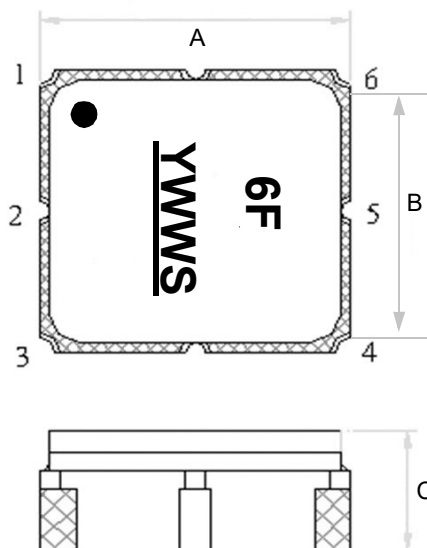

BOTTOM VIEW

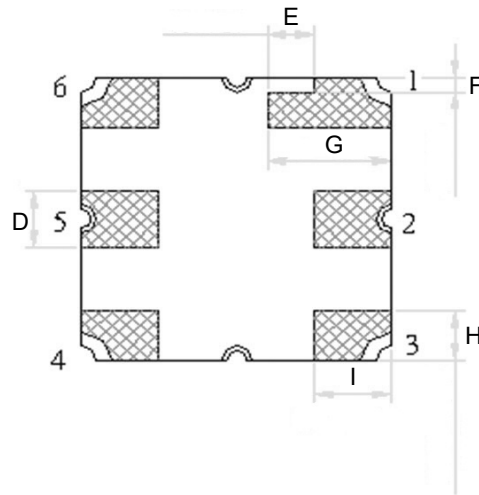

Case Dimensions

Dimension	mm			Inches		
	Min	Nom	Max	Min	Nom	Max
A	2.85	3.0	3.15-	0.151	0.118	0.124
B	2.85	3.0	3.15-	0.151	0.118	0.124
C	-	-	1.4	-	-	0.055
D	0.55	0.60	0.65	0.021	0.023	0.025
E	-	0.45	-	-	0.110	-
F	-	0.15	-	-	0.063	-
G	1.05	1.20	1.35	0.041	0.047	0.053
H	0.38	0.53	0.68	0.014	0.020	0.026
I	0.60	0.75	0.90	0.023	0.029	0.035
J	-	1.70	-	-	0.066	-
K	-	3.20	-	-	0.125	-
L	-	1.05	-	-	0.041	-
M	-	1.10	-	-	0.043	-
N	-	0.90	-	-	0.035	-
O	-	0.30	-	-	0.011	-

Tape and Reel Specifications

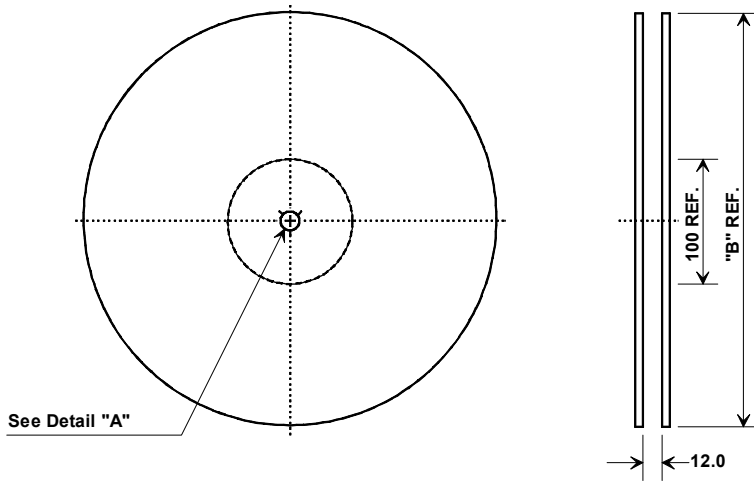

"B"		Quantity Per Reel
Inches	millimeters	
7	178	500
13	330	3000

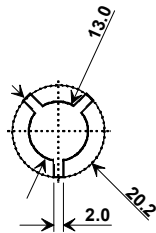

COMPONENT ORIENTATION and DIMENSIONS

Carrier Tape Dimensions	
Ao	4.25 mm
Bo	4.25 mm
Ko	1.3 mm
Pitch	8.0 mm
W	12.0 mm

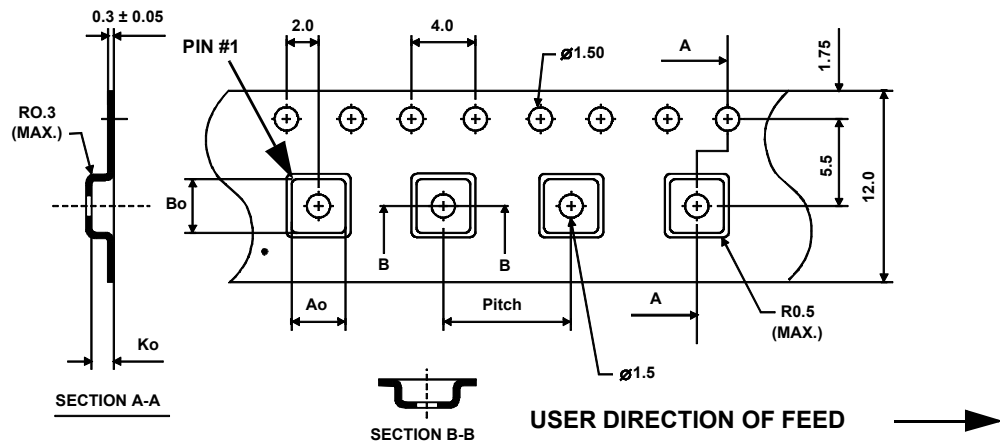

Mouser Electronics

Authorized Distributor

Click to View Pricing, Inventory, Delivery & Lifecycle Information:

[Murata:](#)

[SF2378E](#)

Компания «Life Electronics» занимается поставками электронных компонентов импортного и отечественного производства от производителей и со складов крупных дистрибьюторов Европы, Америки и Азии.

С конца 2013 года компания активно расширяет линейку поставок компонентов по направлению коаксиальный кабель, кварцевые генераторы и конденсаторы (керамические, пленочные, электролитические), за счёт заключения дистрибьюторских договоров

Мы предлагаем:

- Конкурентоспособные цены и скидки постоянным клиентам.
- Специальные условия для постоянных клиентов.
- Подбор аналогов.
- Поставку компонентов в любых объемах, удовлетворяющих вашим потребностям.
- Приемлемые сроки поставки, возможна ускоренная поставка.
- Доставку товара в любую точку России и стран СНГ.
- Комплексную поставку.
- Работу по проектам и поставку образцов.
- Формирование склада под заказчика.
- Сертификаты соответствия на поставляемую продукцию (по желанию клиента).
- Тестирование поставляемой продукции.
- Поставку компонентов, требующих военную и космическую приемку.
- Входной контроль качества.
- Наличие сертификата ISO.

В составе нашей компании организован Конструкторский отдел, призванный помогать разработчикам, и инженерам.

Конструкторский отдел помогает осуществить:

- Регистрацию проекта у производителя компонентов.
- Техническую поддержку проекта.
- Защиту от снятия компонента с производства.
- Оценку стоимости проекта по компонентам.
- Изготовление тестовой платы монтаж и пусконаладочные работы.



Тел: +7 (812) 336 43 04 (многоканальный)
Email: org@lifeelectronics.ru