

MR10Q010-EVAL1 MRAM Evaluation Board

The MR10Q010-EVAL1 MRAM evaluation board from Everspin is an accessory board that is designed to work with the NUCLEO-L476RG MCU evaluation board from ST Microelectronics.

The Evaluation Board

The MR10Q010-EVAL1 is populated with an Everspin 1Mbit Quad SPI MRAM suitable for evaluating any of the following Everspin Ordering Part Numbers:



Everspin OPN	Density	Temperature Grades	Package
MR10Q010SC	1 Mbit	Commercial (0 - 70°C)	16-SOIC
MR10Q010CSC	1 Mbit	Industrial (-40 - 85°C)	16-SOIC
MR10Q010MB	1 Mbit	Commercial (0 - 70°C)	24-BGA
MR10Q010CMB	1 Mbit	Industrial (-40 - 85°C)	24-BGA

Host Board Support

The MR10Q010-EVAL1 Quad SPI MRAM Evaluation board is designed to connect to the MORPHO connectors on the NUCLEO-L476RG evaluation board from ST. The NUCLEO-L476RG uses an STM32L476RGT6 ARM Cortex-M4 CPU that includes a flexible Quad SPI peripheral connected to the MORPHO connector pins. The MR10Q010-EVAL1 board includes a high speed bi directional level translator (TXB0106PWR) in order to shift the I/O level from 3.3V used by the STM32L476RGT6 to the 1.8V required by the MR10Q010. See [Appendix A – MR10Q010-EVAL1 Schematic and Layout](#) for more details.

Host Board Supplier	MCU	Host Board
ST Micro	STM32F476RGT6	NUCLEO-L476RG

SETUP: MR10Q010 - EVAL1 MRAM EVALUATION BOARD

Besides the ST Micro MCU host board and the Everspin MR10Q010 Quad SPI Evaluation board, you will need:

- A computer with Internet access and a USB port.
- A USB cable, with standard A to mini B connectors.

Step 1: *Download and Install the ST-LINK/V2 Driver*

Host Board	Link to Driver Download Page
NUCLEO-L476RG	Link

Step 2: *Plug in the Quad SPI Evaluation board and connect it to your computer via the USB port.*

First, plug the SPI Evaluation board into your MCU host board, then connect the host board to your PC using the USB cable. The MCU host board will enumerate as a composite USB device that includes a built in debugger, storage device and a virtual com port.

A new drive will be created on your computer with a drive name as assigned by the host board.

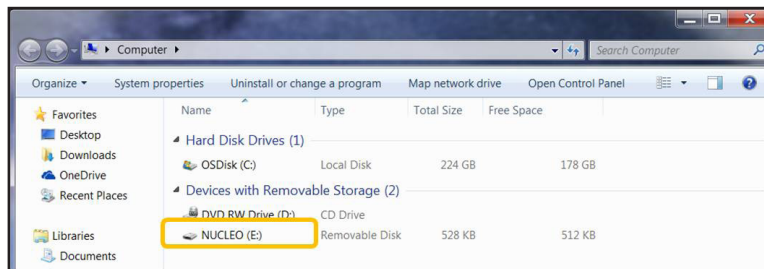
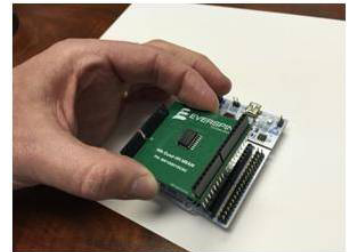

Setup (Continued)

Step 3: Log in to ARM mbed and create a Workspace on your computer.

1. Log in to developer.mbed.org. (If you do not already have an mbed account, you will need to create one.)
2. After logging in, click on the **Compiler** button on the upper right section of the screen.
3. The mbed compiler will bring up the **Workspace Management** screen.

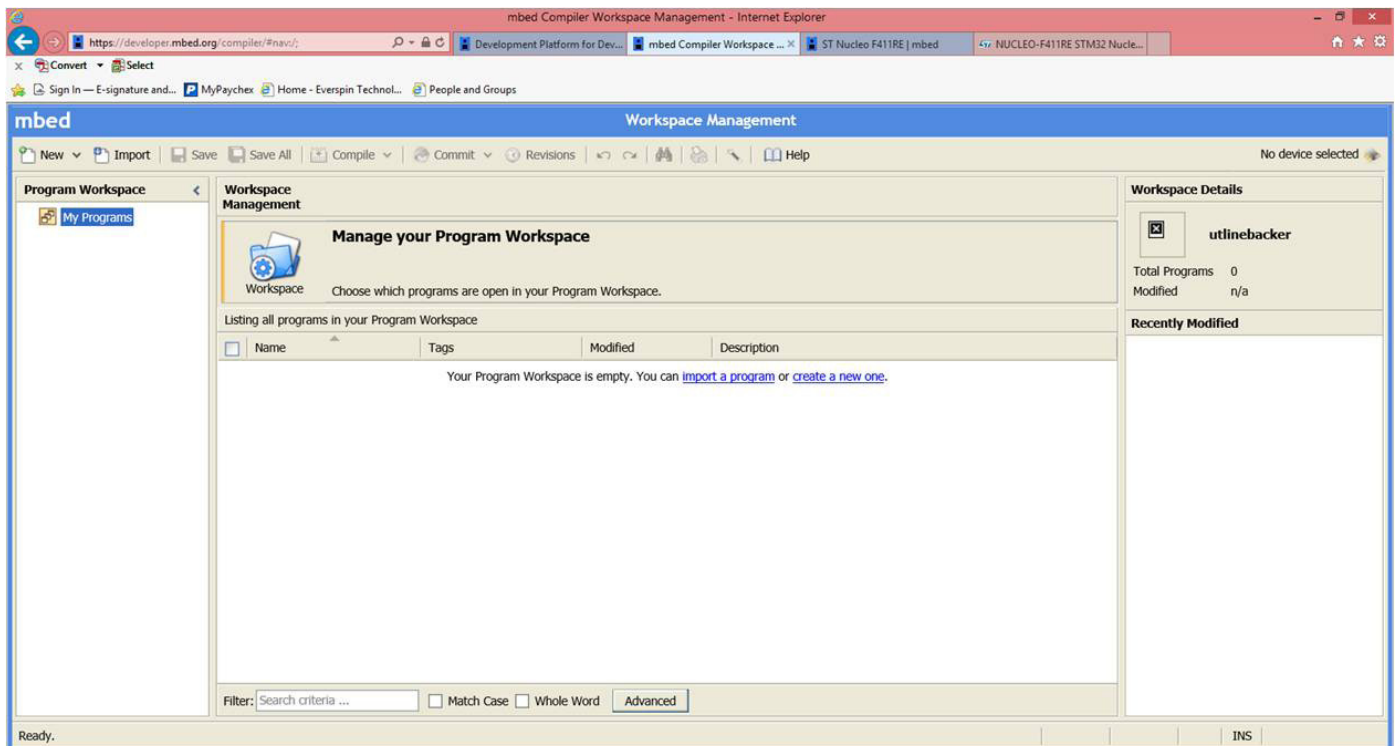
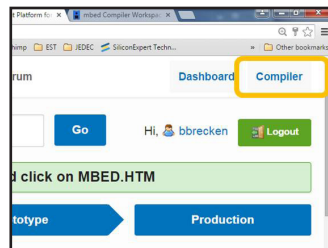

Setup (Continued)

Step 4: Load the platform for the host board you are using

1. The button on the upper right of the Workspace Management screen will read **No device selected** or, if you have previously loaded a platform, the name of the host board for that platform will appear, as in the **NUCLEO-L476RG** case shown.

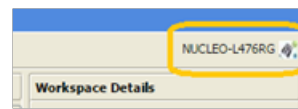
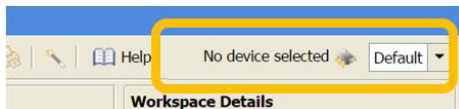

2. In either case, click on the button to open the available compiler platforms screen. Select the host board platform you wish to load or, if it is not present, then select **Add**.
3. *Adding a platform to your Workspace.* If you selected **Add**, mbed will display a scrolling list of avail-

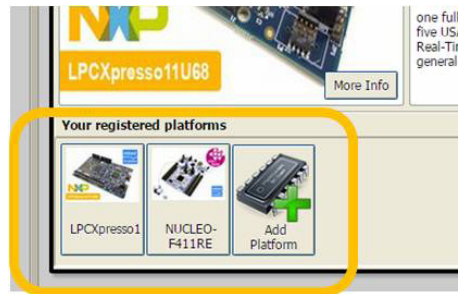

able platforms. Find the MCU host board you are using and click on the image.

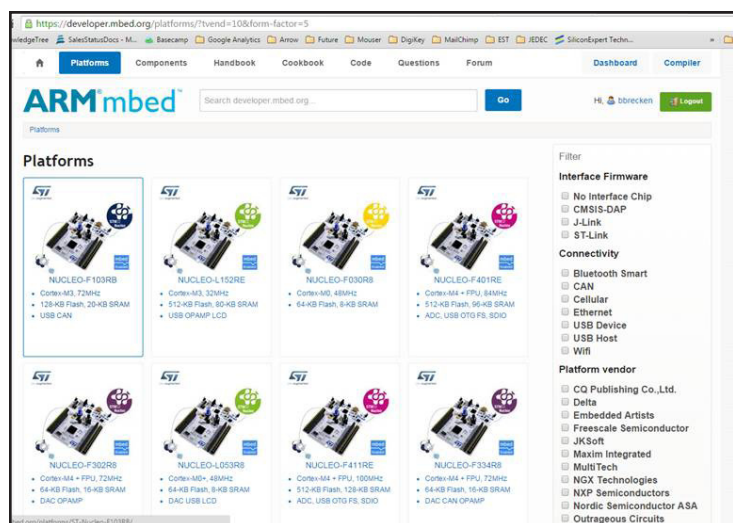

Setup (Continued)

4. **mbed** will open a new window as an information page for that host platform, such as the NUCLEO-L476RG example here. To add this platform to your workspace, click on the **Add to your mbed Compiler** button.

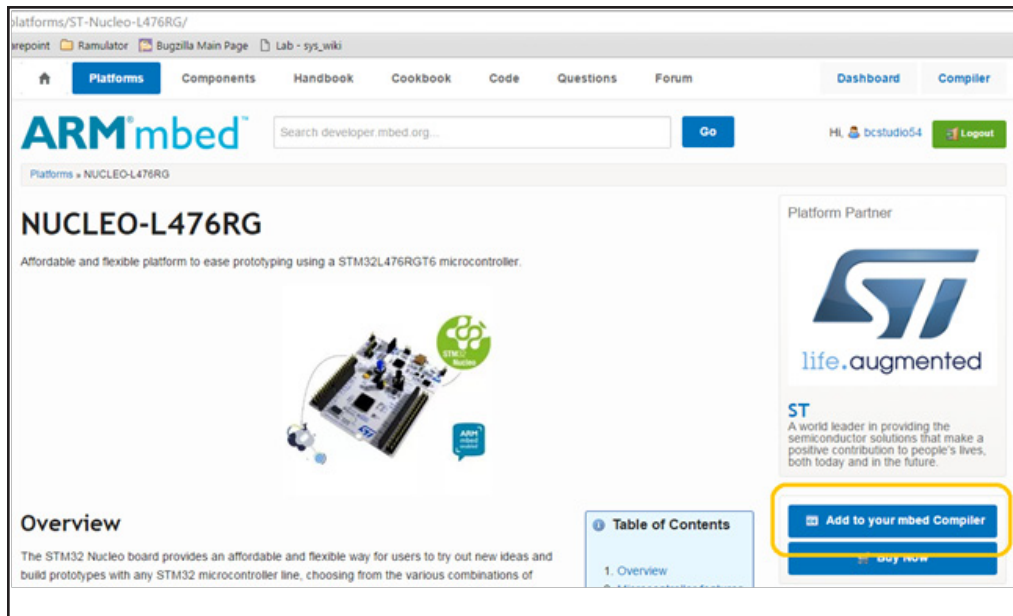

5. The platform will be added to your registered platforms list.

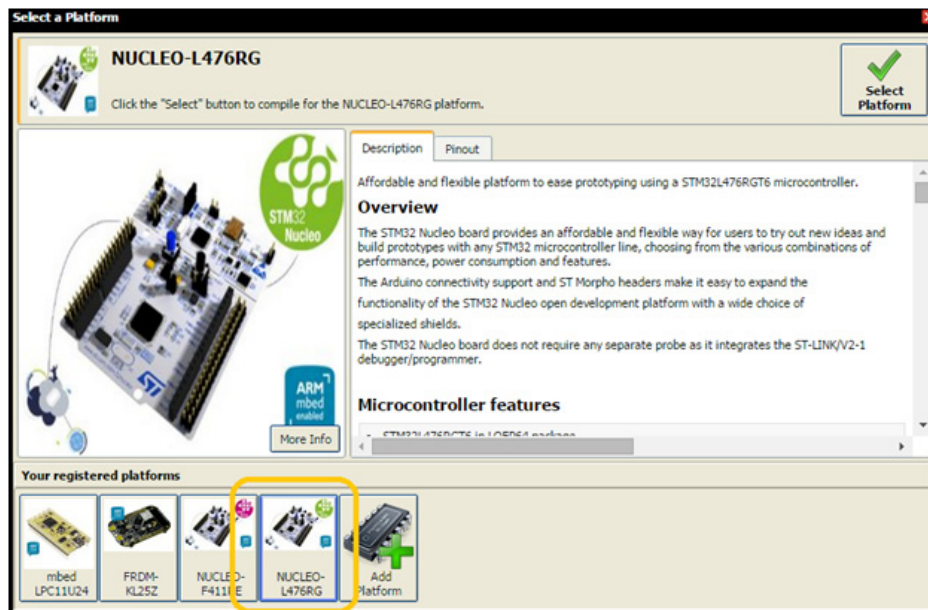

Setup (Continued)

Step 5: *Import the Everspin MR10Q010-EVAL1 demonstration program from www.mbed.org to the Program Workspace.*

1. In your Workspace, click **Import**.

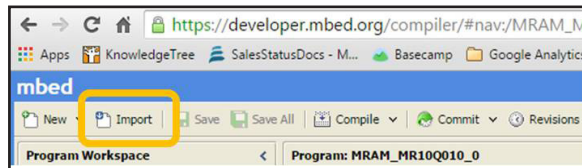

2. The **Import a program** dialog box will open. Click on the **Programs** tab.

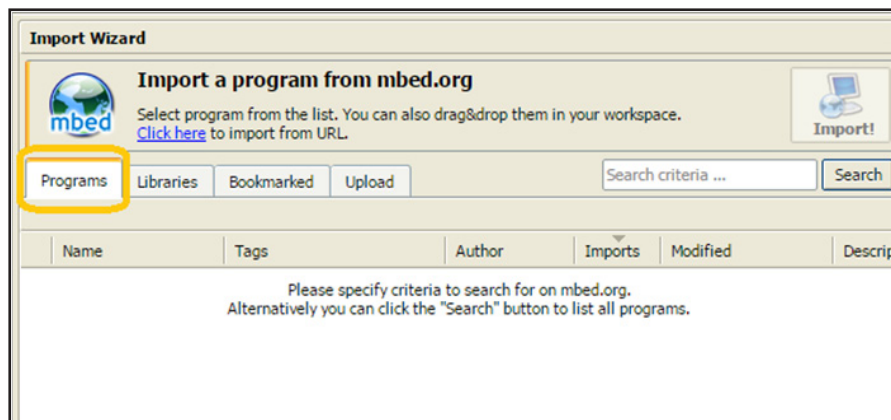

3. Search for "MR10Q010-EVAL1" program, select it and click Import!
4. The demonstration program will now appear in the Program Workspace.

Setup (Concluded)

Step 6: Compile the binary file and load to your MCU evaluation board.

1. Highlight the **MRAM_MR10Q010-EVAL1** program folder in your **Program Workspace** tree in the left-hand column.
2. Click **Compile** in the top menu.

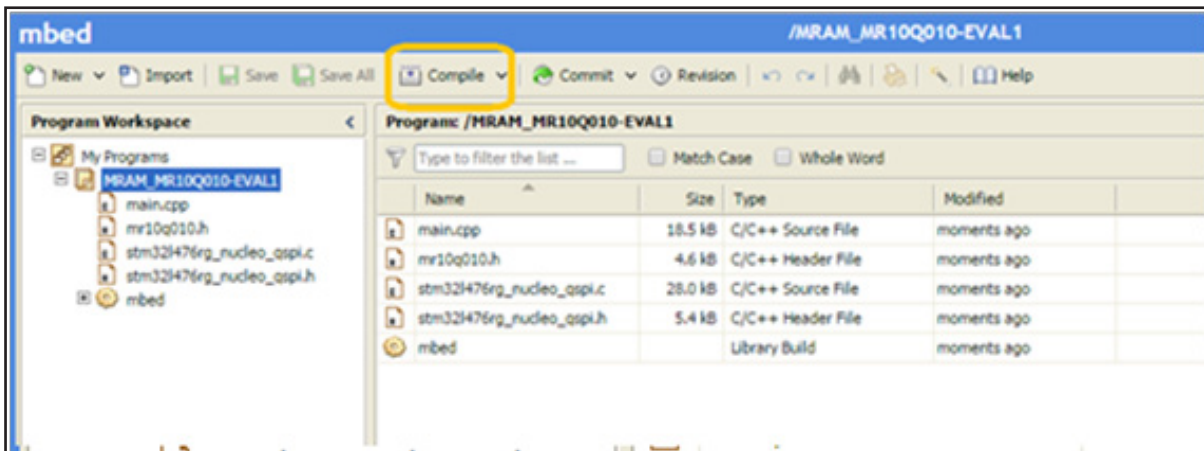

3. The program will be compiled and the binary (.bin) file created will automatically be downloaded to your computer's designated download location.
4. Drag and drop the binary file into the host board drive that you created in **Step 2**. When the file is dropped into the folder, your MCU host board will begin to program. The LED on you host board may blink a few times to confirm that the program is loading. When the program is fully loaded, the binary file will automatically delete from your MCU host board drive.

Run the Demonstration

Step 1: Use a terminal emulator to run the demonstration.

1. Use your favorite terminal emulator. For this example, we used the Tera Term emulator from SourceForge at <http://en.osdn.jp/projects/ttssh2/releases/>.
2. After installing, open Tera Term and select the serial port associated with your host board to create a new connection.

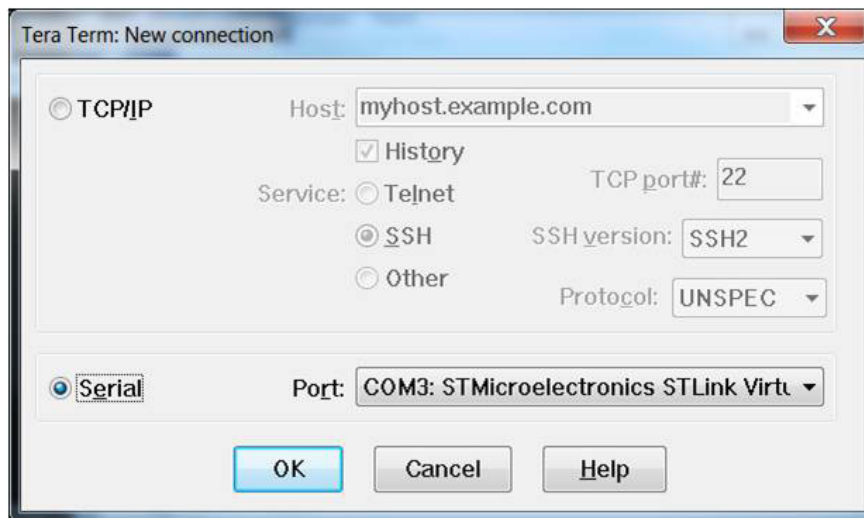

3. Configure the serial port under **Setup->Serial port with: 115200 baud, 8-N-1**.
4. Press any key on the keyboard or the **Reset** button on your MCU host board to run the demonstration and view the demonstration output on the terminal emulator.

Run the Demonstration (Concluded)

5. The evaluation program demonstrates the following features of the MR10Q010 device:
 - Read and decode JEDEC ID
 - Tamper detection bits
 - Nonvolatile test count
 - Performance measurements of SPI, Quad SPI, QPI and XIP modes of operation



```

=====
::                Everspin Technologies                ::
::                The MRAM Company                    ::
=====
::                MR10Q010 mbed Example                ::
::                1Mb MRAM, 40MHz SPI                  ::
=====
=Initializing System...Done!
JEDEC ID = 0x 76b11111
Manufacturer = Everspin Technologies Inc
Technology = Toggle MRAM
Interface = Quad IO SPI
Speed = 104MHz
Density = 1Mbit
Voltage = 3.3V UDD / 1.8V UDDQ
Die Rev = A
MRAM Read: Show Test Count
c0 c0 c0 c0 c0 c0 c0 c0 c0 c0 c0 c0 c0 c0 c0 c0
c0 c0 c0 c0 c0 c0 c0 c0 c0 c0 c0 c0 c0 c0 c0 c0
c0 c0 c0 c0 c0 c0 c0 c0 c0 c0 c0 c0 c0 c0 c0 c0
c0 c0 c0 c0 c0 c0 c0 c0 c0 c0 c0 c0 c0 c0 c0 c0
c0 c0 c0 c0 c0 c0 c0 c0 c0 c0 c0 c0 c0 c0 c0 c0
c0 c0 c0 c0 c0 c0 c0 c0 c0 c0 c0 c0 c0 c0 c0 c0
c0 c0 c0 c0 c0 c0 c0 c0 c0 c0 c0 c0 c0 c0 c0 c0
c0 c0 c0 c0 c0 c0 c0 c0 c0 c0 c0 c0 c0 c0 c0 c0
c0 c0 c0 c0 c0 c0 c0 c0 c0 c0 c0 c0 c0 c0 c0 c0
c0 c0 c0 c0 c0 c0 c0 c0 c0 c0 c0 c0 c0 c0 c0 c0
c0 c0 c0 c0 c0 c0 c0 c0 c0 c0 c0 c0 c0 c0 c0 c0
c0 c0 c0 c0 c0 c0 c0 c0 c0 c0 c0 c0 c0 c0 c0 c0
c0 c0 c0 c0 c0 c0 c0 c0 c0 c0 c0 c0 c0 c0 c0 c0
c0 c0 c0 c0 c0 c0 c0 c0 c0 c0 c0 c0 c0 c0 c0 c0
c0 c0 c0 c0 c0 c0 c0 c0 c0 c0 c0 c0 c0 c0 c0 c0
c0 c0 c0 c0 c0 c0 c0 c0 c0 c0 c0 c0 c0 c0 c0 c0
SPI Mode Write/Read time for 1048576 bits @ 40MHz:
MRAM writing
Time: 0.117850 s   Rate: 1086.126465 KBytes/sec
MRAM reading (and error checking)
Time: 0.129291 s   Rate: 990.014771 KBytes/sec
QSPI Mode Write/Read time for 1048576 bits @ 40MHz:

```

Export the Demonstration Code to Other Toolchains

You may export the demonstration code to work with other ARM-based toolchains.

1. Once you have the Everspin MR10Q010-EVAL1 example program loaded into ARM mbed you may export it for development in production ARM tool chains.
2. Right click on the MRAM_MR10Q010-EVAL1 program in the left column of the workspace and select **Export Program**.
3. Using **Export Target** and **Export Toolchain** in the dialog box, pick the target MCU host board and Toolchain for export and click on the **Export** button. The Everspin MR10Q010-EVAL1 example code will be exported to the tool chain you selected.

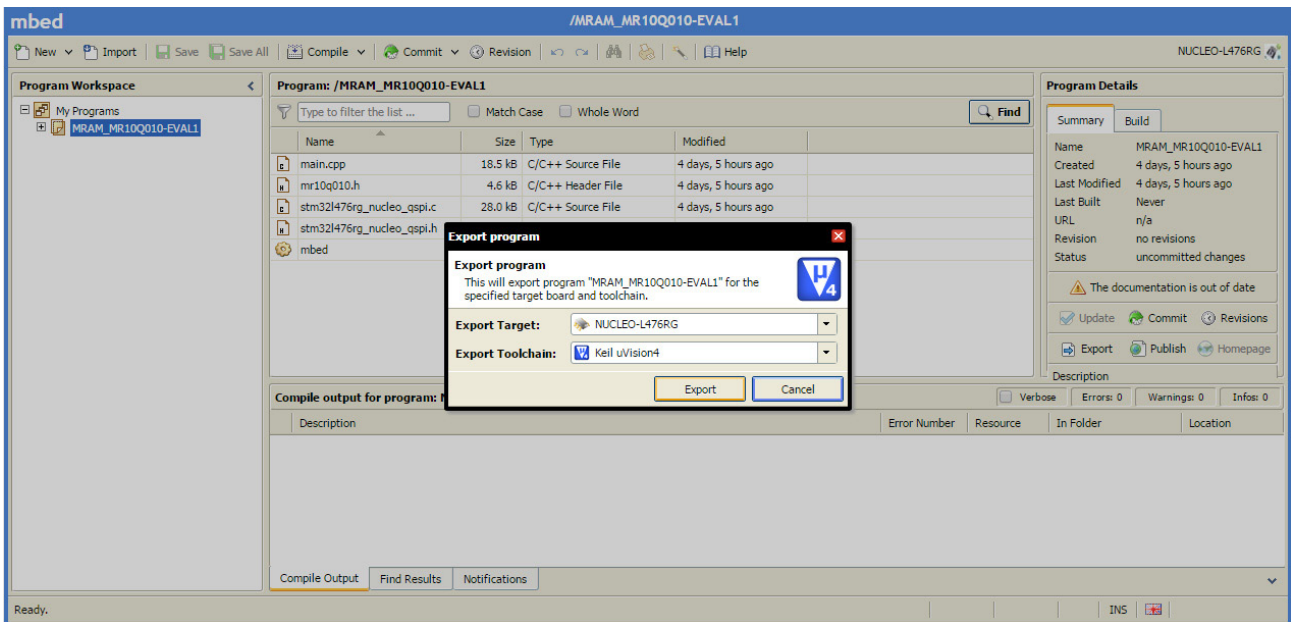

Questions?

We are here to help. Please use the Information Request on our web site to let us know how we can be of assistance.

Appendix A: MR10Q010-EVAL1 Schematic

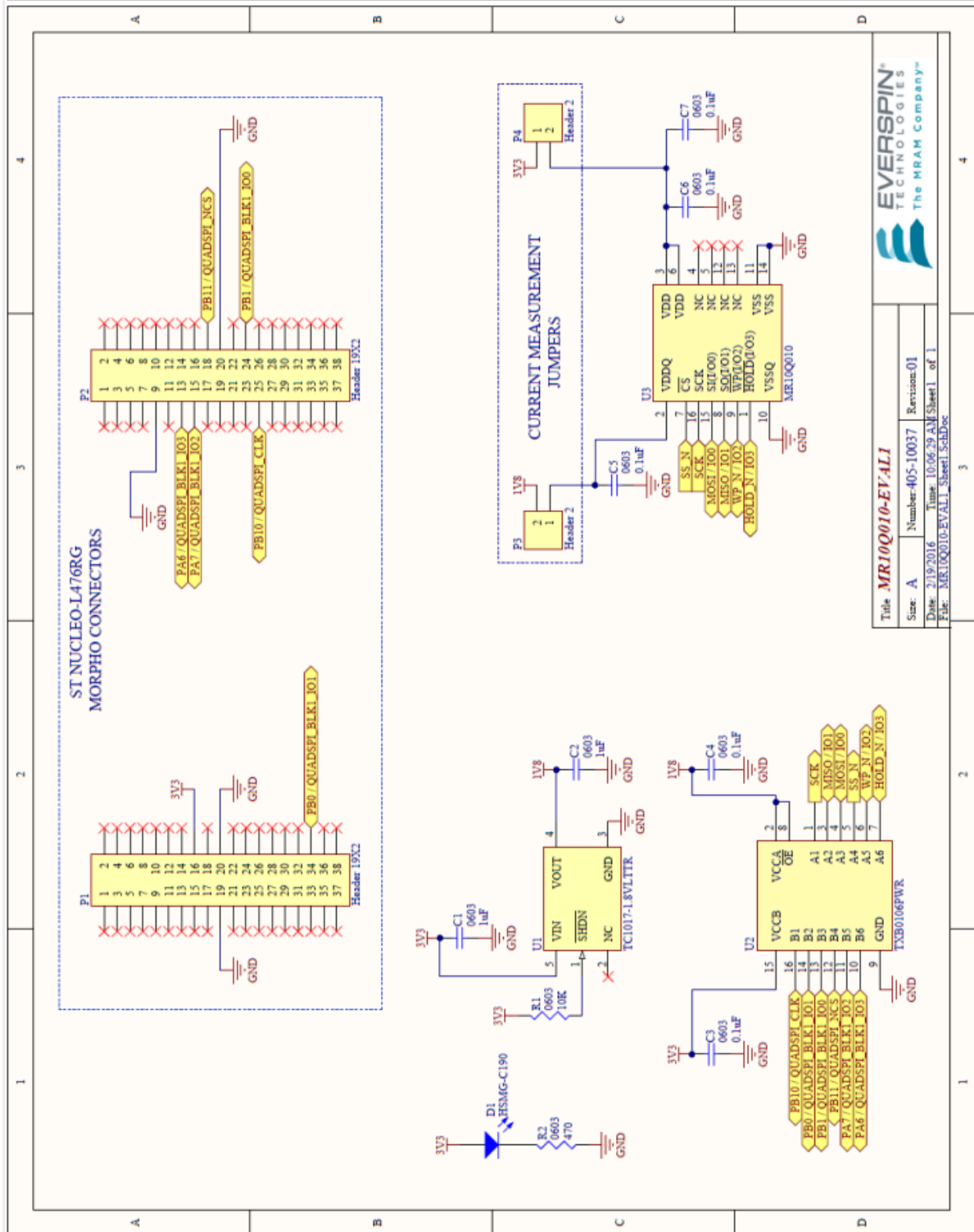

Appendix A (Cont'd): MR10Q010-EVAL1 PCB Layout

PCB Top

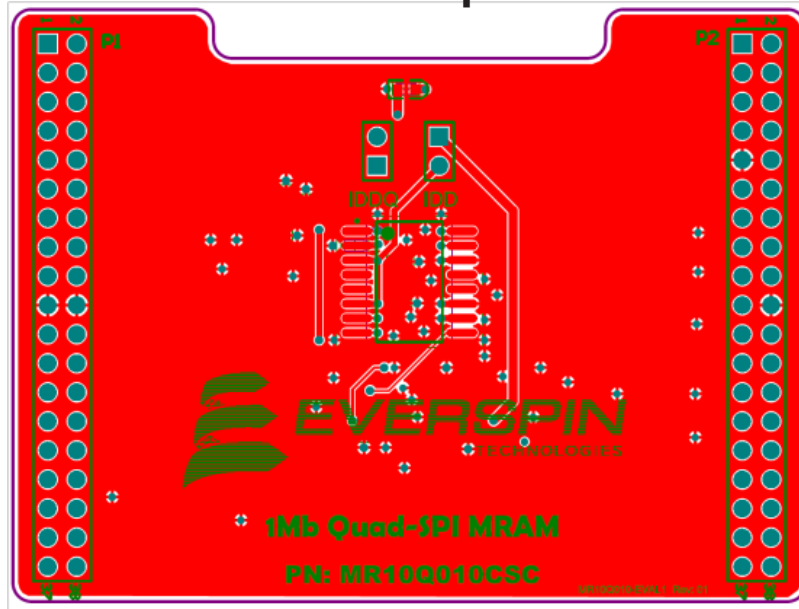

PCB Bottom

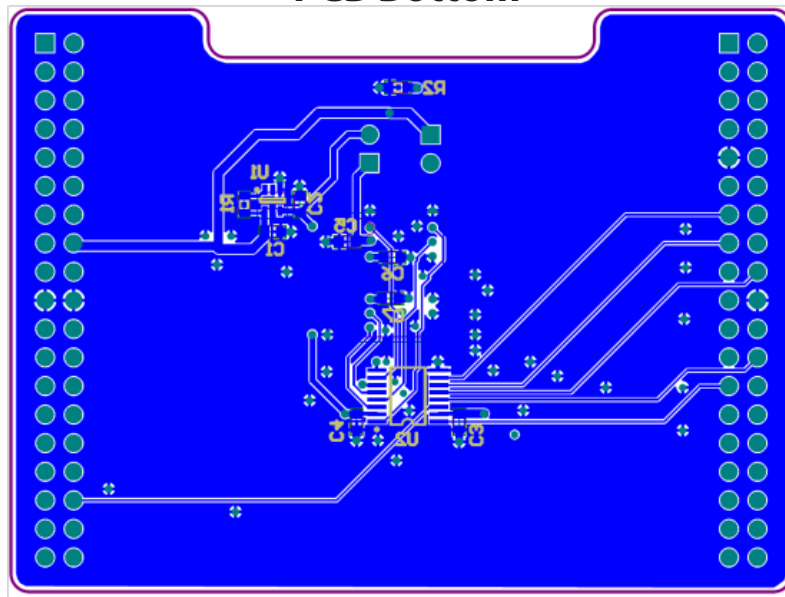

REVISION HISTORY

Revision	Date	Description of Change
1.0	February 24, 2016	Initial Release MR10Q010-EVAL1 User Guide.

HOW TO REACH US

Everspin Technologies, Inc.

Home Page:

www.everspin.com

World Wide Information Request**WW Headquarters - Chandler, AZ**

1347 N. Alma School Road, Suite 220
Chandler, Arizona 85224

Tel: +1-877-480-MRAM (6726)

Local Tel: +1-480-347-1111

Fax: +1-480-347-1175

Europe, Middle East and Africa

Everspin Sales Office

Tel: +49 8168 998019

Japan

Everspin Sales Office

Tel: +1 (719) 650-5012

Asia Pacific

Everspin Sales Office

Tel: +86-136-0307-6129

Fax: +1-480-347-1175

Filename:

MR10Q010QuadSPIEvaluationBoardGuideRevision1022416

Information in this document is provided solely to enable system and software implementers to use Everspin Technologies products. There are no express or implied licenses granted hereunder to design or fabricate any integrated circuit or circuits based on the information in this document. Everspin Technologies reserves the right to make changes without further notice to any products herein. Everspin makes no warranty, representation or guarantee regarding the suitability of its products for any particular purpose, nor does Everspin Technologies assume any liability arising out of the application or use of any product or circuit, and specifically disclaims any and all liability, including without limitation consequential or incidental damages. "Typical" parameters, which may be provided in Everspin Technologies data sheets and/or specifications can and do vary in different applications and actual performance may vary over time. All operating parameters including "Typicals" must be validated for each customer application by customer's technical experts. Everspin Technologies does not convey any license under its patent rights nor the rights of others. Everspin Technologies products are not designed, intended, or authorized for use as components in systems intended for surgical implant into the body, or other applications intended to support or sustain life, or for any other application in which the failure of the Everspin Technologies product could create a situation where personal injury or death may occur. Should Buyer purchase or use Everspin Technologies products for any such unintended or unauthorized application, Buyer shall indemnify and hold Everspin Technologies and its officers, employees, subsidiaries, affiliates, and distributors harmless against all claims, costs, damages, and expenses, and reasonable attorney fees arising out of, directly or indirectly, any claim of personal injury or death associated with such unintended or unauthorized use, even if such claim alleges that Everspin Technologies was negligent regarding the design or manufacture of the part. Everspin™ and the Everspin logo are trademarks of Everspin Technologies, Inc. All other product or service names are the property of their respective owners.

Copyright © 2016 Everspin Technologies, Inc.

Компания «Life Electronics» занимается поставками электронных компонентов импортного и отечественного производства от производителей и со складов крупных дистрибьюторов Европы, Америки и Азии.

С конца 2013 года компания активно расширяет линейку поставок компонентов по направлению коаксиальный кабель, кварцевые генераторы и конденсаторы (керамические, пленочные, электролитические), за счёт заключения дистрибьюторских договоров

Мы предлагаем:

- Конкурентоспособные цены и скидки постоянным клиентам.
- Специальные условия для постоянных клиентов.
- Подбор аналогов.
- Поставку компонентов в любых объемах, удовлетворяющих вашим потребностям.
- Приемлемые сроки поставки, возможна ускоренная поставка.
- Доставку товара в любую точку России и стран СНГ.
- Комплексную поставку.
- Работу по проектам и поставку образцов.
- Формирование склада под заказчика.
- Сертификаты соответствия на поставляемую продукцию (по желанию клиента).
- Тестирование поставляемой продукции.
- Поставку компонентов, требующих военную и космическую приемку.
- Входной контроль качества.
- Наличие сертификата ISO.

В составе нашей компании организован Конструкторский отдел, призванный помогать разработчикам, и инженерам.

Конструкторский отдел помогает осуществить:

- Регистрацию проекта у производителя компонентов.
- Техническую поддержку проекта.
- Защиту от снятия компонента с производства.
- Оценку стоимости проекта по компонентам.
- Изготовление тестовой платы монтаж и пусконаладочные работы.



Тел: +7 (812) 336 43 04 (многоканальный)
Email: org@lifeelectronics.ru