

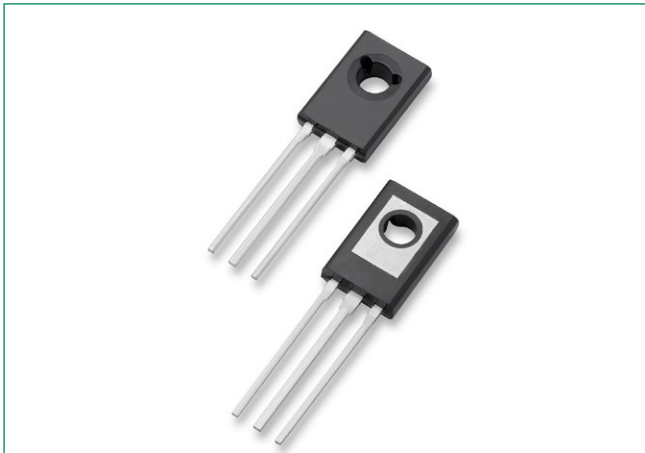

2N6071A/B Series

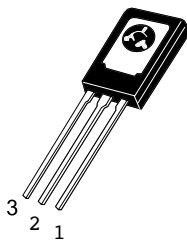

Pin Out



**REAR VIEW
SHOW TAB**

**TO-225
CASE 077
STYLE 5**

1. Cathode
2. Anode
3. Gate

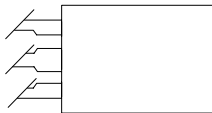

Description

Designed primarily for full-wave AC control applications, such as light dimmers, motor controls, heating controls and power supplies; or wherever full-wave silicon gate controlled solid-state devices are needed. Triac type thyristors switch from a blocking to a conducting state for either polarity of applied anode voltage with positive or negative gate triggering.

Features

- Sensitive Gate Triggering Uniquely Compatible for Direct Coupling to TTL, HTL, CMOS and Operational Amplifier Integrated Circuit Logic Functions
- Gate Triggering: 4 Mode - 2N6071A, B; 2N6073A, B; 2N6075A, B
- Blocking Voltages to 600 V
- All Diffused and Glass Passivated Junctions for Greater Parameter Uniformity and Stability
- Small, Rugged, Thermopad Construction for Low Thermal Resistance, High Heat Dissipation and Durability
- Device Marking: Device Type, e.g., 2N6071A, Date Code

Functional Diagram

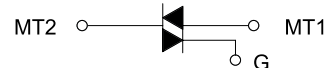

Additional Information



Datasheet



Resources



Samples

Maximum Ratings and Thermal Characteristics (T_J = 25°C unless otherwise noted)

Rating	Symbol	Value	Unit
Peak Repetitive Off-State Voltage (Note 1) (T _J = -40 to 110°C, Sine Wave, 50 to 60 Hz, Gate Open) 2N6071A,B 2N6073A,B 2N6075A,B	V _{DRM} [] V _{RPM}	200 400 600	-
*On-State RMS Current (T _C = 85°C) Full Cycle Sine Wave 50 to 60 Hz	I _{T(RMS)}	4.0	A
*Peak Non-repetitive Surge Current (One Full cycle, 60 Hz, T _J = +110°C)	I _{TSM}	30	A
Circuit Fusing Considerations (t = 8.3 ms)	I _{zt}	3.7	A2s
*Peak Gate Power (Pulse Width "1.0 μs, T _C = 85°C)	P _{GM}	10	W
*Average Gate Power (t = 8.3 ms, T _C = 85°C)	P _{G(AV)}	0.5	W
*Peak Gate Voltage (Pulse Width "1.0 μs, T _C = 85°C)	V _{GM}	5.0	V
*Operating Junction Temperature Range	T _J	-40 to +110	°C
*Storage Temperature Range	T _{stg}	-40 to +150	°C
Mounting Torque (6-32 Screw) (Note 2)	-	8.0	in. lb.

Stresses exceeding Maximum Ratings may damage the device. Maximum Ratings are stress ratings only. Functional operation above the Recommended Operating Conditions is not implied. Extended exposure to stresses above the Recommended Operating Conditions may affect device reliability.

- V_{DRM} and V_{RPM} for all types can be applied on a continuous basis. Blocking voltages shall not be tested with a constant current source such that the voltage ratings of the devices are exceeded.
- Torque rating applies with use of a compression washer. Mounting torque in excess of 6 in. lb. does not appreciably lower case-to-sink thermal resistance. Main terminal 2 and heatsink contact pad are common.

Thermal Characteristics

Rating	Symbol	Value	Unit
*Thermal Resistance, Junction to Case	R _{θJC}	3.5	°C/W
Thermal Resistance, Junction to Ambient (Note 1)	R _{θJA}	75	°C/W
Maximum Lead Temperature for Soldering Purposes, 1/8" from case for 10 seconds	T _L	260	°C

*Indicates JEDEC Registered Data.

Electrical Characteristics - OFF (T_C = 25°C unless otherwise noted; Electricals apply in both directions)

Characteristic	Symbol	Min	Typ	Max	Unit
*Peak Repetitive Blocking Current (T _J = 25°C (V _D = V _{DRM} = V _{RPM} ; Gate Open) T _J = 110°C)	I _{DRM} , I _{RRM}	-	-	10	μA
		-	-	2	mA

Electrical Characteristics - ON (T_C = 25°C unless otherwise noted; Electricals apply in both directions)

Characteristic	Symbol	Min	Typ	Max	Unit	
*Peak On-State Voltage (Note 3) (I _{TM} = ±6.0 A Peak)	C	-	-	2	V	
*Gate Trigger Voltage (Continuous DC), All Quadrants (Main Terminal Voltage = 12 Vdc, R _i = 100 Ω, T _J = -40 °C)	VGT	-	1.4	2.5	V	
Gate Non-Trigger Voltage, All Quadrants (Main Terminal Voltage = 12 Vdc, R _L = 100 Ω, T _J = 110°C)	VGD	.02	-	-	V	
*Holding Current (Main Terminal Voltage = 12 Vdc, Gate Open, Initiating Current = ±1 Adc)	I _H	-	-	30	mA	
		-	-	15	mA	
Turn-On Time (I _{TM} = 14 Adc, I _{GT} = 100 mAdc)	tgt	-	1.5	-	μs	
QUADRANT (Maximum Value)						
	Type	IGT @ T _J	I mA	II mA	III mA	IV mA
Gate Trigger Current (Continuous DC) (Main Terminal Voltage = 12 Vdc, R _L = 100 Ω)	2N6071A	+25°C	5	5	5	10
	2N6073A	-40°C	20	20	20	30
	2N6075A	-40°C	20	20	20	30
	2N6071B	+25°C	3	3	3	5
	2N6073B	-40°C	15	15	15	20
	2N6075B	-40°C	15	15	15	20

3. Pulse Test: Pulse Width ≤ 2.0 ms, Duty Cycle ≤ 2%.

*Indicates JEDEC Registered Data.

Dynamic Characteristics

Characteristic	Symbol	Min	Typ	Max	Unit
Critical Rate of Rise of Commutation Voltage @ V_{DRM} , $T_J = 85^\circ\text{C}$, Gate Open, $I_{TM} = 5.7\text{ A}$, Exponential Waveform, Commutating $di/dt = 2.0\text{ A/ms}$	$dv/dt(c)$	-	5	10	$\text{V}/\mu\text{s}$

SAMPLE APPLICATION: TTL-Sensitive Gate 4 Ampere Triac Triggers in Modes II and III

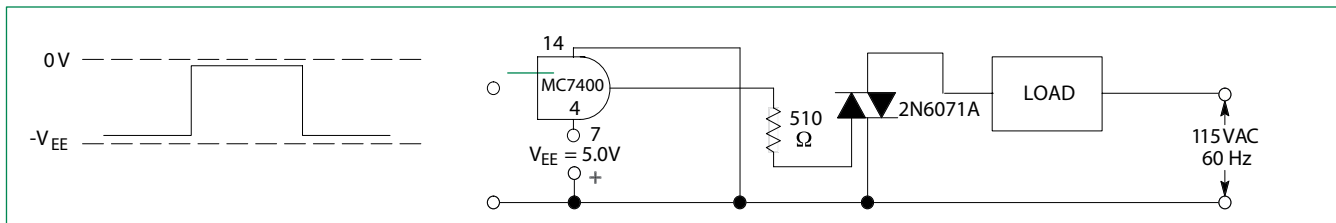

Trigger devices are recommended for gating on Triacs. They provide:

1. Consistent predictable turn-on points.
2. Simplified circuitry.
3. Fast turn-on time for cooler, more efficient and reliable operation.

Voltage Current Characteristic of Triacs (Bidirectional Device)

Symbol	Parameter
V_{DRM}	Peak Repetitive Forward Off State Voltage
I_{DRM}	Peak Forward Blocking Current
V_{RRM}	Peak Repetitive Reverse Off State Voltage
I_{RRM}	Peak Reverse Blocking Current
V_{TM}	Maximum On State Voltage
I_H	Holding Current

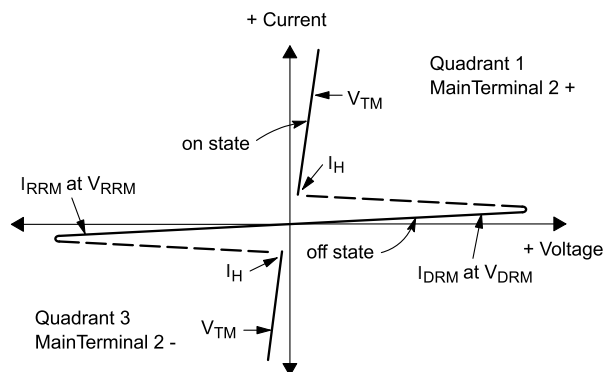

Sensitive Gate Logic Reference

IC Logic Functions	Firing Quadrant			
	I	II	III	IV
TTL	-	2N6071A Series	2N6071A Series	-
HTL	-	2N6071A Series	2N6071A Series	-
CMOS (NAND)	2N6071B Series	-	-	2N6071B Series
CMOS (Buffer)	-	2N6071B Series	2N6071B Series	-
Operational Amplifier	2N6071A Series	-	-	2N6071A Series
Zero Voltage Switch	-	2N6071A Series	2N6071A Series	-

Quadrant Definitions for a Triac

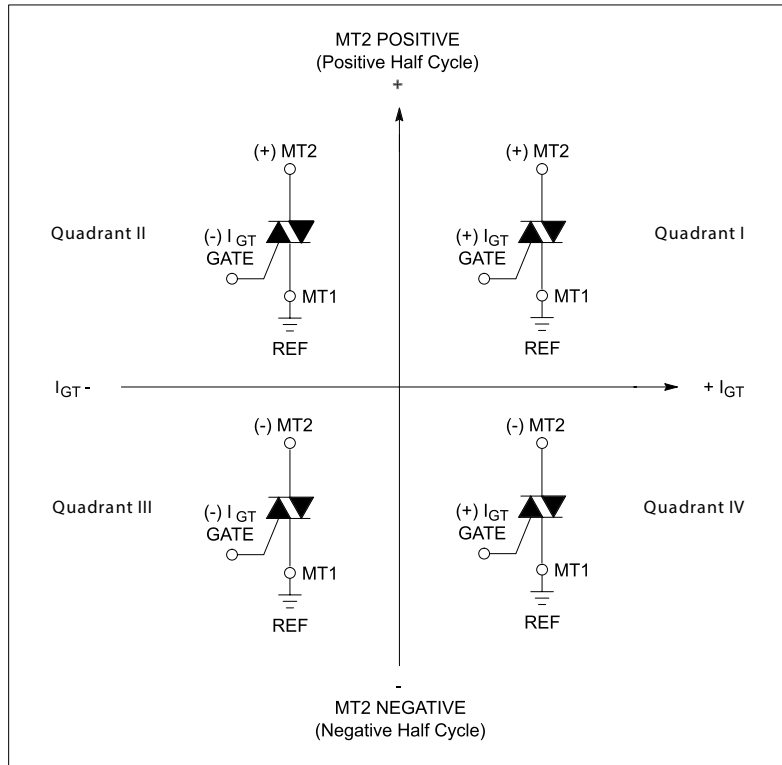

Ratings and Characteristic Curves

Figure 1. Average Current Derating

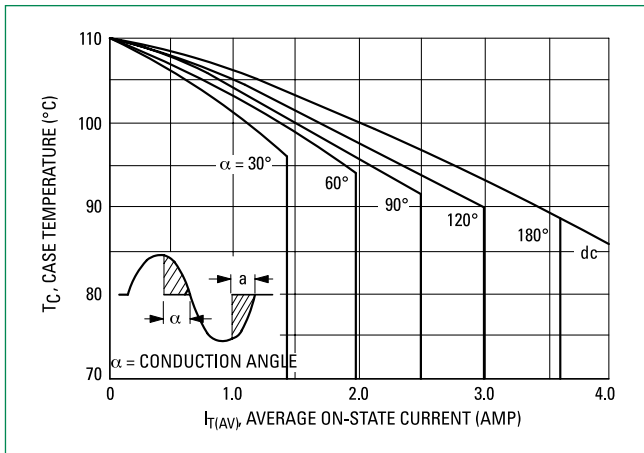

Figure 2. RMS Current Derating

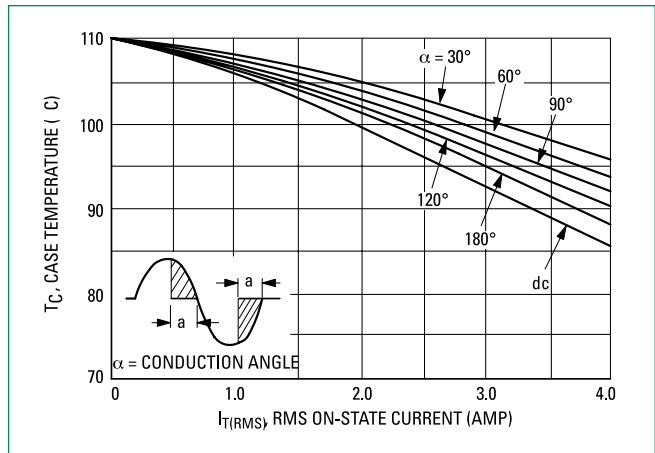

Figure 3. Power Dissipation

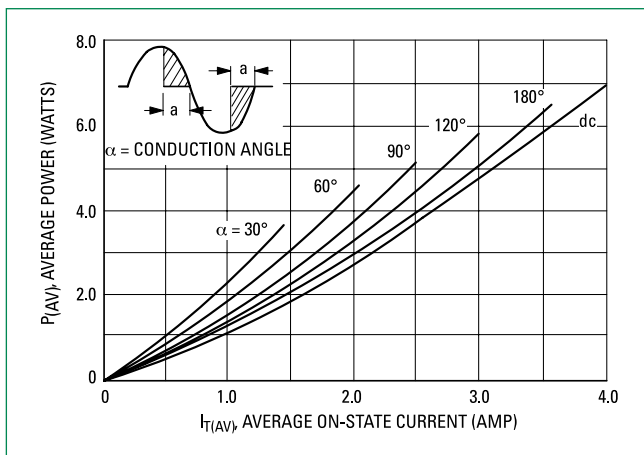

Figure 4. Power Dissipation

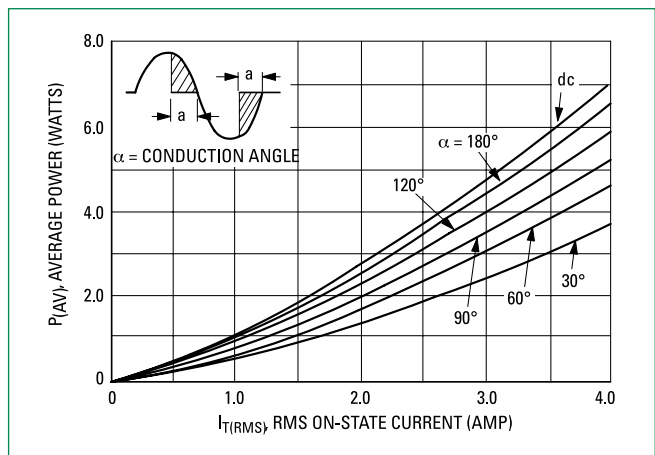

Figure 5. Typical Gate-Trigger Voltage

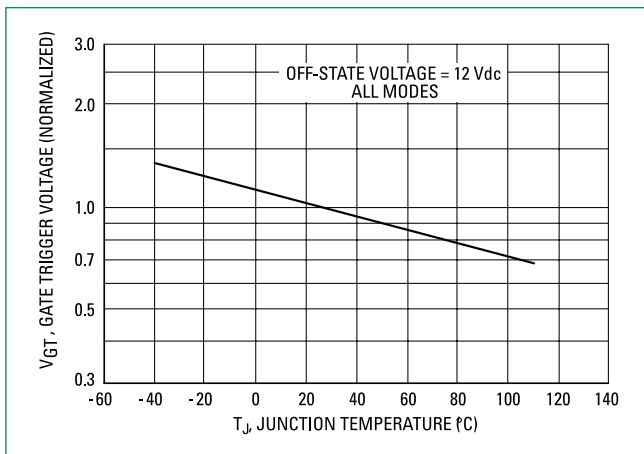

Figure 6. Typical Gate-Trigger Current

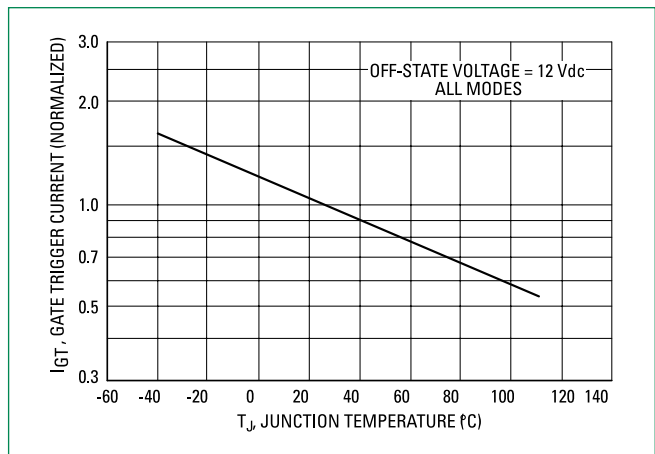

Figure 7. Maximum On-State Characteristics

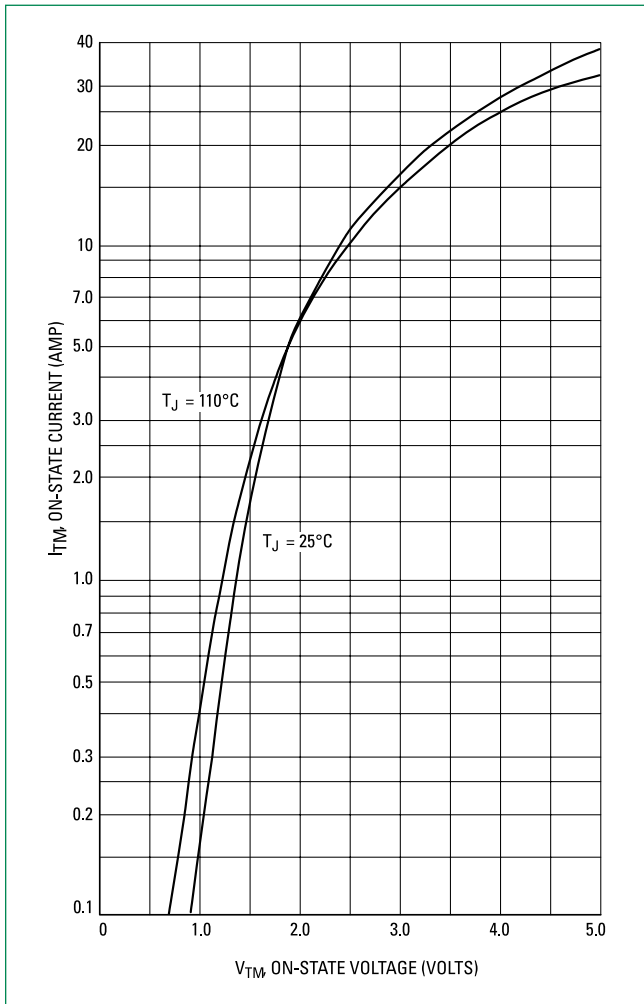

Figure 8. Typical Holding Current

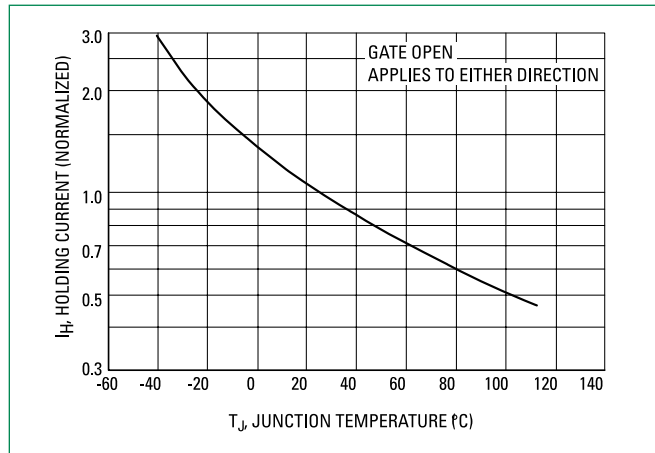

Figure 9. Maximum Allowable Surge Current

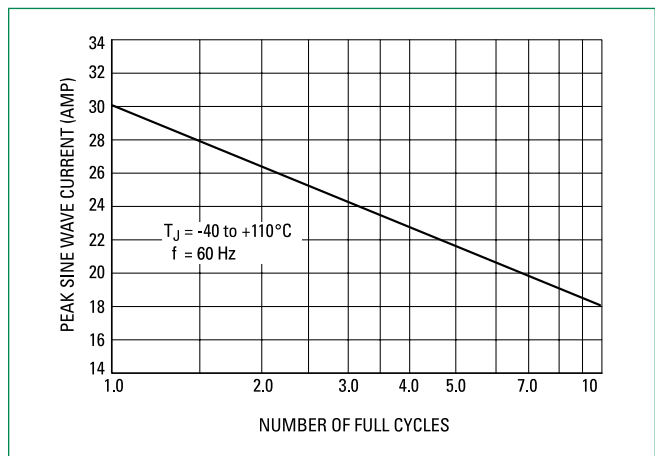
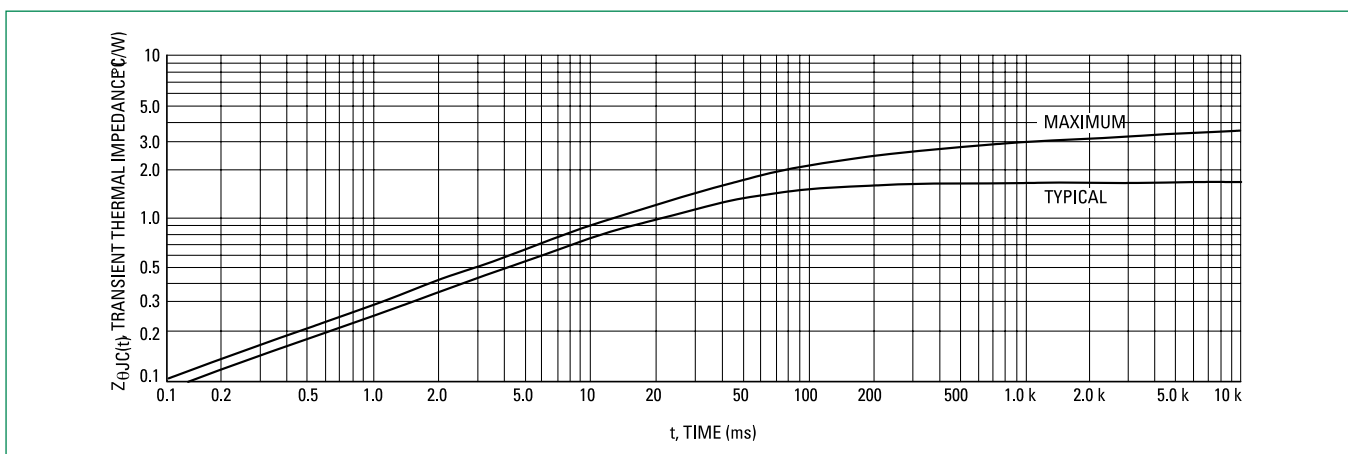
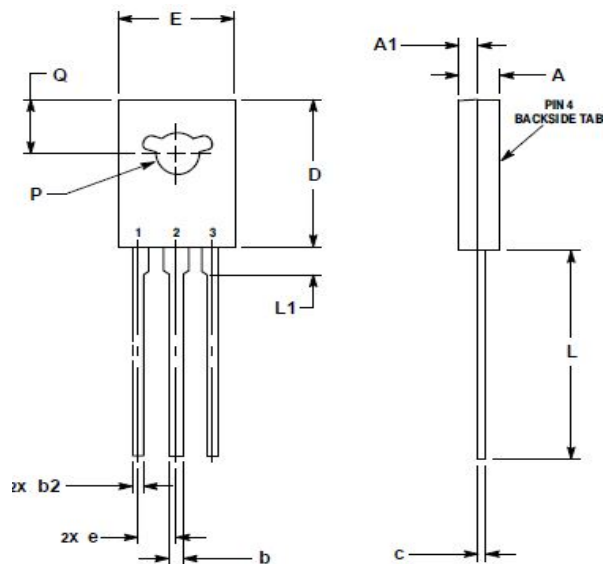

Figure 10. Thermal Response



Dimensions



Dim	Inches		Millimeters	
	Min	Max	Min	Max
A	0.102	0.110	2.60	2.80
A1	0.047	0.055	1.20	1.40
b	0.028	0.034	0.70	0.86
b2	0.028	0.034	0.70	0.86
c	0.019	0.022	0.49	0.57
D	0.417	0.449	10.60	11.40
E	0.291	0.323	7.40	8.20
e	0.090 TYP		2.29 TYP	
L	0.551	0.630	14.00	16.00
L1	0.091	0.106	2.30	2.70
P	0.118	0.134	3.00	3.40
Q	0.142	0.157	3.60	4.00

1. DIMENSIONING AND TOLERANCING PER ANSI Y14.5M, 1982.
2. CONTROLLING DIMENSION: INCH.
3. 077-01 THRU -08 OBSOLETE, NEW STANDARD 077-09.

Part Marking System

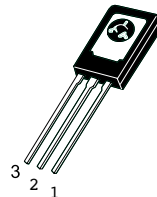

REAR VIEW
SHOW TAB

TO-225
CASE 077
STYLE 5

1. Cathode
2. Anode
3. Gate

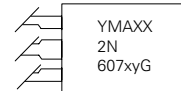

x = 1,3,5
y = A,B
Y = Year
M = Month
A = Assembly Site
XX = Lot Serial Code

Ordering Information

Device	Package	Shipping†
2N6071A	TO-225	2500 Units / Box
2N6071AG	TO-225 (Pb-Free)	
2N6071AT	TO-225	50 Units / Tube 1920 Units / Box
2N6071ATG	TO-225 (Pb-Free)	
2N6071B	TO-225	2500 Units / Box
2N6071BG	TO-225 (Pb-Free)	
2N6071BT	TO-225	50 Units / Tube 1920 Units / Box
2N6071BTG	TO-225 (Pb-Free)	
2N6073A	TO-225	2500 Units / Box
2N6073AG	TO-225 (Pb-Free)	
2N6073B	TO-225	
2N6073BG	TO-225 (Pb-Free)	
2N6075A	TO-225	
2N6075AG	TO-225 (Pb-Free)	
2N6075B	TO-225	
2N6075BG	TO-225 (Pb-Free)	

Disclaimer Notice - Information furnished is believed to be accurate and reliable. However, users should independently evaluate the suitability of and test each product selected for their own applications. Littelfuse products are not designed for, and may not be used in, all applications. Read complete Disclaimer Notice at <http://www.littelfuse.com/disclaimer-electronics>.

Компания «Life Electronics» занимается поставками электронных компонентов импортного и отечественного производства от производителей и со складов крупных дистрибьюторов Европы, Америки и Азии.

С конца 2013 года компания активно расширяет линейку поставок компонентов по направлению коаксиальный кабель, кварцевые генераторы и конденсаторы (керамические, пленочные, электролитические), за счёт заключения дистрибьюторских договоров

Мы предлагаем:

- Конкуренеспособные цены и скидки постоянным клиентам.
- Специальные условия для постоянных клиентов.
- Подбор аналогов.
- Поставку компонентов в любых объемах, удовлетворяющих вашим потребностям.
- Приемлемые сроки поставки, возможна ускоренная поставка.
- Доставку товара в любую точку России и стран СНГ.
- Комплексную поставку.
- Работу по проектам и поставку образцов.
- Формирование склада под заказчика.
- Сертификаты соответствия на поставляемую продукцию (по желанию клиента).
- Тестирование поставляемой продукции.
- Поставку компонентов, требующих военную и космическую приемку.
- Входной контроль качества.
- Наличие сертификата ISO.

В составе нашей компании организован Конструкторский отдел, призванный помогать разработчикам, и инженерам.

Конструкторский отдел помогает осуществить:

- Регистрацию проекта у производителя компонентов.
- Техническую поддержку проекта.
- Защиту от снятия компонента с производства.
- Оценку стоимости проекта по компонентам.
- Изготовление тестовой платы монтаж и пусконаладочные работы.



Тел: +7 (812) 336 43 04 (многоканальный)
Email: org@lifeelectronics.ru