

4K/16K I²C Serial EERAM

Device Selection Table

Part Number	Density (bits)	Vcc Range	Max. Clock Frequency	Temperature Ranges	Packages
47L04	4K	2.7-3.6V	1 MHz	I, E	P, SN, ST
47C04	4K	4.5-5.5V	1 MHz	I, E	P, SN, ST
47L16	16K	2.7-3.6V	1 MHz	I, E	P, SN, ST
47C16	16K	4.5-5.5V	1 MHz	I, E	P, SN, ST

Features

- 4 Kbit/16 Kbit SRAM with EEPROM Backup:
 - Internally organized as 512 x 8 bits (47X04) or 2,048 x 8 bits (47X16)
 - Automatic Store to EEPROM array upon power-down (using optional external capacitor)
 - Automatic Recall to SRAM array upon power-up
 - Hardware Store pin for manual Store operations
 - Software commands for initiating Store and Recall operations
 - Store time 8 ms maximum (47X04) or 25 ms maximum (47X16)
- Nonvolatile External Event Detect Flag
- High Reliability:
 - Infinite read and write cycles to SRAM
 - More than one million store cycles to EEPROM
 - Data retention: >200 years
 - ESD protection: >4,000V
- High-Speed I²C Interface:
 - Industry standard 100 kHz, 400 kHz and 1 MHz
 - Zero cycle delay reads and writes
 - Schmitt Trigger inputs for noise suppression
 - Cascadable up to four devices
- Write Protection:
 - Software write protection from 1/64 of SRAM array to whole array
- Low-Power CMOS Technology:
 - 200 μ A active current typical
 - 40 μ A standby current (maximum)
- 8-Lead PDIP, SOIC, and TSSOP Packages
- Available Temperature Ranges:
 - Industrial (I): -40°C to +85°C
 - Automotive (E): -40°C to +125°C

Description

The Microchip Technology Inc. 47L04/47C04/47L16/47C16 (47XXX) is a 4/16 Kbit SRAM with EEPROM backup. The device is organized as 512 x 8 bits or 2,048 x 8 bits of memory, and utilizes the I²C serial interface. The 47XXX provides infinite read and write cycles to the SRAM while EEPROM cells provide high-endurance nonvolatile storage of data. With an external capacitor, SRAM data is automatically transferred to the EEPROM upon loss of power. Data can also be transferred manually by using either the Hardware Store pin or software control. Upon power-up, the EEPROM data is automatically recalled to the SRAM. Recall can also be initiated through software control.

The 47XXX is available in the 8-lead PDIP, SOIC, and TSSOP packages.

Block Diagram



47L04/47C04/47L16/47C16

Typical Application Schematic Auto Store Mode (ASE = 1)



Typical Application Schematic Manual Store Mode (ASE = 0)



Package Types



47L04/47C04/47L16/47C16

1.0 ELECTRICAL CHARACTERISTICS

1.1 Absolute Maximum Ratings^(†)

V _{CC}	6.5V
A1, A2, SDA, SCL, HS pins w.r.t. V _{SS}	-0.6V to 6.5V
Storage temperature	-65°C to +150°C
Ambient temperature under bias.....	-40°C to +125°C
ESD protection on all pins.....	≥4 kV

† **NOTICE:** Stresses above those listed under 'Absolute Maximum Ratings' may cause permanent damage to the device. This is a stress rating only and functional operation of the device at those or any other conditions above those indicated in the operational listings of this specification is not implied. Exposure to maximum rating conditions for an extended period of time may affect device reliability.

TABLE 1-1: DC CHARACTERISTICS

DC CHARACTERISTICS			47LXX: V _{CC} = 2.7V to 3.6V 47CXX: V _{CC} = 4.5V to 5.5V Industrial (I): T _A = -40°C to +85°C Automotive (E): T _A = -40°C to +125°C				
Param. No.	Symbol	Characteristic	Min.	Typ.	Max.	Units	Conditions
D1	V _{IH}	High-Level Input Voltage	0.7*V _{CC}	—	V _{CC} +1	V	
D2	V _{IL}	Low-Level Input Voltage	-0.3	—	0.3*V _{CC}	V	
D3	V _{OL}	Low-Level Output Voltage	—	—	0.4	V	I _{OL} = 3.0 mA
D4	V _{HYS}	Hysteresis of Schmitt Trigger Inputs (SDA, SCL pins)	0.05*V _{CC}	—	—	V	Note 1
D5	I _{LI}	Input Leakage Current (SDA, SCL pins)	—	—	±1	µA	V _{IN} = V _{SS} or V _{CC}
D6	I _{LO}	Output Leakage Current (SDA pin)	—	—	±1	µA	V _{OUT} = V _{SS} or V _{CC}
D7	R _{IN}	Input Resistance to V _{SS} (A1, A2, HS pins)	50	—	—	kΩ	V _{IN} = V _{IL} (max.)
			750	—	—	kΩ	V _{IN} = V _{IH} (min.)
D8	C _{INT}	Internal Capacitance (all inputs and outputs)	—	—	7	pF	T _A = +25°C, FREQ = 1 MHz, V _{CC} = 5.5V (Note 1)
D9	I _{CC} Active	Operating Current	—	200	400	µA	V _{CC} = 5.5V, FCLK = 1 MHz
			—	150	300	µA	V _{CC} = 3.6V, FCLK = 1 MHz
D10	I _{CC} Recall	Recall Current (Note 2)	—	—	700	µA	V _{CC} = 5.5V
			—	300	500	µA	V _{CC} = 3.6V
D11	I _{CC} Store	Manual Store Current (Note 2)	—	—	2000	µA	V _{CC} = 5.5V
			—	—	1000	µA	V _{CC} = 3.6V
D12	I _{CC} Auto-Store	Auto-Store Current (Notes 1, 2 and 3)	—	400	—	µA	V _{CC} , V _{CAP} = V _{TRIP} (min.) 47CXX
			—	300	—	µA	V _{CC} , V _{CAP} = V _{TRIP} (min.) 47LXX

Note 1: This parameter is periodically sampled and not 100% tested.

2: Store and Recall currents are specified as an average current across the entire operation.

3: C_VCAP required when Auto-Store is enabled (ASE = 1).

47L04/47C04/47L16/47C16

TABLE 1-1: DC CHARACTERISTICS (CONTINUED)

DC CHARACTERISTICS			47LXX: VCC = 2.7V to 3.6V 47CXX: VCC = 4.5V to 5.5V Industrial (I): TA = -40°C to +85°C Automotive (E): TA = -40°C to +125°C				
Param. No.	Symbol	Characteristic	Min.	Typ.	Max.	Units	Conditions
D13	ICC Status Write	Status Write Current	—	—	1000	μA	VCC = 5.5V
			—	—	800	μA	VCC = 3.6V
D14	ICCS	Standby Current	—	—	40	μA	SCL, SDA, VCAP, VCC = 5.5V
			—	—	40	μA	SCL, SDA, VCAP, VCC = 3.6V
D15	VTRIP	Auto-Store/Auto-Recall Trip Voltage	4.0	—	4.4	V	47CXX
			2.4	—	2.6	V	47LXX
D16	VPOR	Power-On Reset Voltage	—	1.1	—	V	
D17	CB	Bus Capacitance	—	—	400	pF	
D18	CVCAP	Auto-Store Capacitance (Notes 1 and 3)	3.5	4.7	—	μF	47C04
			5	6.8	—	μF	47C16
			5	6.8	—	μF	47L04
			8	10	—	μF	47L16

Note 1: This parameter is periodically sampled and not 100% tested.

2: Store and Recall currents are specified as an average current across the entire operation.

3: CVCAP required when Auto-Store is enabled (ASE = 1).

47L04/47C04/47L16/47C16

TABLE 1-2: AC CHARACTERISTICS

AC CHARACTERISTICS			47LXX:	VCC = 2.7V to 3.6V			
			47CXX:	VCC = 4.5V to 5.5V			
			Industrial (I):	TAMB = -40°C to +85°C			
			Automotive (E):	TAMB = -40°C to +125°C			
Param. No.	Symbol	Characteristic	Min.	Max.	Units	Conditions	
1	FCLK	Clock Frequency	—	1000	kHz		
2	THIGH	Clock High Time	500	—	ns		
3	TLOW	Clock Low Time	500	—	ns		
4	TR	SDA and SCL Input Rise Time	—	300	ns	Note 1	
5	TF	SDA and SCL Input Fall Time	—	300	ns	Note 1	
6	THD:STA	Start Condition Hold Time	250	—	ns		
7	TSU:STA	Start Condition Setup Time	250	—	ns		
8	THD:DAT	Data Input Hold Time	0	—	ns		
9	TSU:DAT	Data Input Setup Time	100	—	ns		
10	TSU:STO	Stop Condition Setup Time	250	—	ns		
11	TAA	Output Valid from Clock	—	400	ns		
12	TBUF	Bus Free Time: Bus time must be free before a new transmission can start	500	—	ns		
13	TSP	Input Filter Spike Suppression (SDA, SCL and HS pins)	—	50	ns	Note 1	
14	THSPW	Hardware Store Pulse Width	150	—	ns		
15	TRECALL	Recall Operation Duration	—	5	ms	47X16	
			—	2	ms	47X04	
16	TSTORE	Store Operation Duration	—	25	ms	47X16	
			—	8	ms	47X04	
17	TWC	STATUS Register Write Cycle Time	—	1	ms		
18	TVRISE	VCC Rise Rate	70	—	µs/V	Note 1	
19	TVFALL	VCC Fall Rate	70	—	µs/V	Note 1	
20		EEPROM Endurance	1,000,000	—	Store cycles	+25°C, VCC = 5.5V (Notes 1 and 2)	

Note 1: This parameter is not tested but ensured by characterization.

2: For endurance estimates in a specific application, please consult the Total Endurance Model which can be obtained on Microchip's website at www.microchip.com.

47L04/47C04/47L16/47C16

FIGURE 1-1: BUS TIMING DATA



FIGURE 1-2: AUTO-STORE/AUTO-RECALL TIMING DATA



FIGURE 1-3: HARDWARE STORE TIMING DATA (WITH AM = 1)

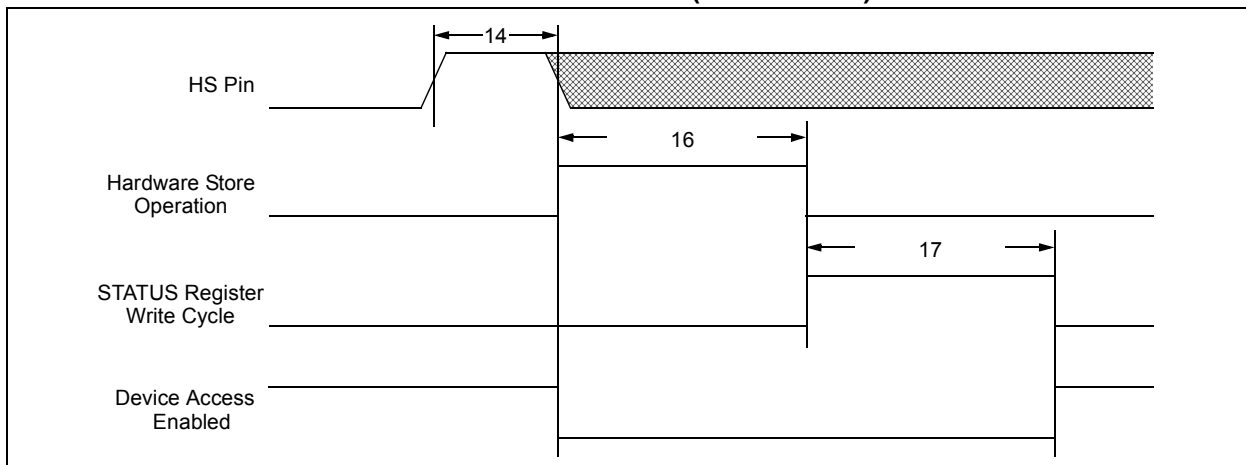

FIGURE 1-4: HARDWARE STORE TIMING DATA (WITH AM = 0)



47L04/47C04/47L16/47C16

2.0 FUNCTIONAL DESCRIPTION

2.0.1 PRINCIPLES OF OPERATION

The 47XXX is a 4/16 Kbit serial EERAM designed to support a bidirectional two-wire bus and data transmission protocol (I²C). A device that sends data onto the bus is defined as transmitter, and a device receiving data is defined as receiver. The bus has to be controlled by a master device which generates the Start and Stop conditions, while the 47XXX works as slave. Both master and slave can operate as transmitter or receiver, but the master device determines which mode is active.

2.1 Bus Characteristics

2.1.1 SERIAL INTERFACE

The following **bus protocol** has been defined:

- Data transfer may be initiated only when the bus is not busy.
- During data transfer, the data line must remain stable whenever the clock line is high. Changes in the data line while the clock line is high will be interpreted as a Start or Stop condition.

Accordingly, the following bus conditions have been defined (Figure 2-1).

2.1.1.1 Bus Not Busy (A)

Both data and clock lines remain high.

2.1.1.2 Start Data Transfer (B)

A high-to-low transition of the SDA line while the clock (SCL) is high determines a Start condition. All commands must be preceded by a Start condition.

2.1.1.3 Stop Data Transfer (C)

A low-to-high transition of the SDA line while the clock (SCL) is high determines a Stop condition. All operations must end with a Stop condition.

2.1.1.4 Data Valid (D)

The state of the data line represents valid data when, after a Start condition, the data line is stable for the duration of the high period of the clock signal.

The data on the line must be changed during the low period of the clock signal. There is one bit of data per clock pulse.

Each data transfer is initiated with a Start condition and terminated with a Stop condition. The number of the data bytes transferred between the Start and Stop conditions is determined by the master device.

2.1.1.5 Acknowledge

Each receiving device, when addressed, is obliged to generate an Acknowledge signal after the reception of each byte. The master device must generate an extra clock pulse which is associated with this Acknowledge bit.

A device that Acknowledges must pull down the SDA line during the Acknowledge clock pulse in such a way that the SDA line is stable low during the high period of the Acknowledge related clock pulse. Of course, setup and hold times must be taken into account. During reads, a master must signal an end of data to the slave by NOT generating an Acknowledge bit on the last byte that has been clocked out of the slave. In this case, the slave (47XXX) will leave the data line high to enable the master to generate the Stop Condition.

There are situations where the 47XXX will NOT generate an Acknowledge bit in order to signal that an error has occurred. Table 2-1 and Table 2-2 summarize these situations.

FIGURE 2-1: DATA TRANSFER SEQUENCE ON THE SERIAL BUS

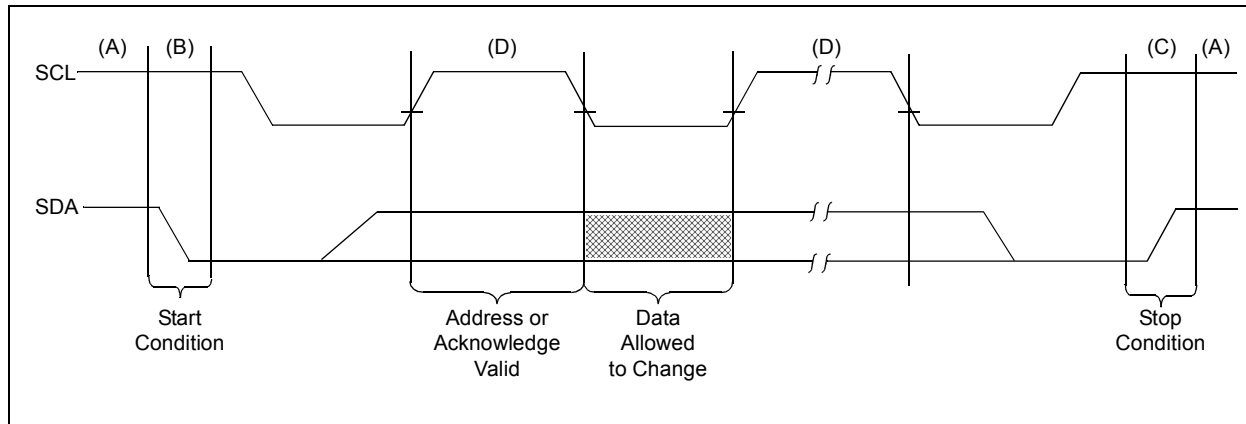

FIGURE 2-2: ACKNOWLEDGE TIMING



TABLE 2-1: ACKNOWLEDGE TABLE FOR SRAM WRITES

Instruction	ACK	Address MSB	ACK	Address LSB	ACK	Data Byte	ACK
SRAM Write in Unprotected Block	ACK	Address	ACK	Address	ACK	Data	ACK
SRAM Write in Protected Block	ACK	Address	ACK	Address	ACK	Data	NoACK

TABLE 2-2: ACKNOWLEDGE TABLE FOR CONTROL REGISTER WRITES

Instruction	ACK	Address	ACK	Data Byte	ACK
STATUS Register Write	ACK	00h	ACK	Data	ACK
Software Store Command	ACK	55h	ACK	33h	ACK
Software Recall Command	ACK	55h	ACK	DDh	ACK
Write Invalid Value to COMMAND Register	ACK	55h	ACK	Invalid Command	NoACK
Write to Invalid Register Address	ACK	Invalid Address	NoACK	Don't Care	NoACK

47L04/47C04/47L16/47C16

2.2 Device Addressing

The control byte is the first byte received following the Start condition from the master device (Figure 2-3). The control byte begins with a 4-bit operation code. The next two bits are the user-configurable Chip Select bits: A2 and A1. The next bit is a non-configurable Chip Select bit that must always be set to '0'. The Chip Select bits A2 and A1 in the control byte must match the logic levels on the corresponding A2 and A1 pins for the device to respond.

The last bit of the control byte defines the operation to be performed. When set to a '1' a read operation is selected, and when set to a '0' a write operation is selected.

The combination of the 4-bit operation code and the three Chip Select bits is called the slave address. Upon receiving a valid slave address, the slave device outputs an acknowledge signal on the SDA line. Depending on the state of the R/W bit, the 47XXX will select a read or a write operation.

Note: When VCAP is below VTRIP, the 47XXX cannot be accessed and will not acknowledge any commands.

The 47XXX is divided into two functional units: the SRAM array and the Control registers. Section 2.3 "SRAM Array" describes the functionality for the SRAM array and Section 2.4 "Control Registers" describes the Control registers.

The 4-bit op code in the control byte determines which unit will be accessed during an operation. Table 2-3 shows the standard control bytes used by the 47XXX.

TABLE 2-3: CONTROL BYTES

Operation	Op Code	Chip Select	R/W Bit
SRAM Read	1010	A2 A1 0	1
SRAM Write	1010	A2 A1 0	0
Control Register Read	0011	A2 A1 0	1
Control Register Write	0011	A2 A1 0	0

FIGURE 2-3: CONTROL BYTE FORMAT



2.3 SRAM Array

The SRAM array is the only directly-accessible memory on the 47XXX. The EEPROM array provides nonvolatile storage to back up the SRAM data.

To select the SRAM array, the master device must use the respective 4-bit op code '1010' when transmitting the control byte.

Note: If an Auto-Store or Hardware Store is triggered during an SRAM read or write operation, the operation is aborted in order to execute the Store.

2.3.1 WRITE OPERATION

When the SRAM array is selected and the $\overline{R\overline{W}}$ bit in the control byte is set to '0', a write operation is selected and the next two bytes received are interpreted as the array address. The Most Significant address bits are transferred first, followed by the less significant bits, and are shifted directly into the internal Address Pointer. The Address Pointer determines where in the SRAM array the next read or write operation begins.

Data bytes are stored into the SRAM array as soon as each byte is received, specifically on the rising edge of SCL during each Acknowledge bit. If a write operation is aborted for any reason, all received data will already be stored in SRAM, except for the last data byte if the rising edge of SCL during the Acknowledge for that byte has not yet been reached.

Note: If an attempt is made to write to a protected portion of the array, the device will not respond with an Acknowledge after the data byte is received, the current operation will be terminated without incrementing the Address Pointer, and any data transmitted on the SDA line will be ignored until a new operation is begun with a Start condition.

2.3.1.1 Byte Write

After the 47XXX has received the 2-byte array address, responding with an Acknowledge after each address byte, the master device will transmit the data byte to be written into the addressed memory location. The 47XXX acknowledges again, and the master generates a Stop condition (Figure 2-4). The data byte is latched into the SRAM array on the rising edge of SCL during the Acknowledge.

After a byte Write command, the internal Address Pointer will point to the address location following the location that was just written.

2.3.1.2 Sequential Write

To write multiple data bytes in a single operation, the SRAM write control byte, array address, and the first data byte are transmitted to the 47XXX in the same way as for a byte write. However, instead of generating a Stop condition, the master transmits additional data bytes (Figure 2-5). Upon receipt of each byte, the 47XXX responds with an Acknowledge: during which the data is latched into the SRAM array on the rising edge of SCL, and the Address Pointer is incremented by one. Sequential write operations are limited only by the size of the SRAM array, and if the master should transmit enough bytes to reach the end of the array, the Address Pointer will roll over to 0x000 and continue writing. There is no limit to the number of bytes that can be written in a single command.

Note: If a sequential write crosses into a protected block, the device will not respond with an Acknowledge after the data byte is received, the current operation will be terminated without incrementing the Address Pointer, and any data transmitted on the SDA line will be ignored until a new operation is begun with a Start condition.

FIGURE 2-4: SRAM BYTE WRITE



47L04/47C04/47L16/47C16

FIGURE 2-5: SRAM SEQUENTIAL WRITE

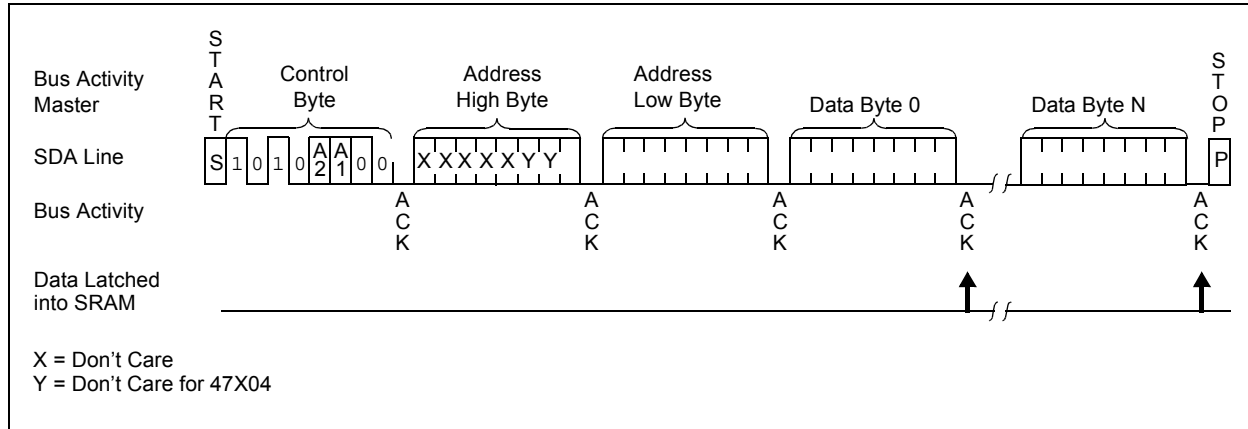

2.3.2 READ OPERATION

When the SRAM array is selected and the $\overline{R/W}$ bit is set to '1', a read operation is selected. For read operations, the array address is not transmitted. Instead, the internal Address Pointer is used to determine where the read starts.

During read operations, the master device generates the Acknowledge bit after each data byte, and it is this bit which determines whether the operation will continue or end. A '0' (Acknowledge) bit requests more data and continues the read, while a '1' (No Acknowledge) bit ends the read operation.

2.3.2.1 Current Address Read

The current address read operation relies on the current value of the Address Pointer to determine from where to start reading. The Address Pointer is automatically incremented after each data byte is read or written. Therefore, if the previous access was to address 'n' (where 'n' is any legal address), the next current address read operation would access data beginning with address 'n+1'.

Upon receipt of the control byte with the $\overline{R/W}$ bit set to '1', the 47XXX issues an Acknowledge and transmits the 8-bit data byte. The master will not acknowledge the transfer, but does generate a Stop condition and the 47XXX discontinues transmission (Figure 2-6).

FIGURE 2-6: SRAM CURRENT ADDRESS READ



2.3.2.2 Random Read

Random read operations allow the master to access any memory location in a random manner. To perform this type of read operation, first the Address Pointer must be set. This is done by sending the array address to the 47XXX as part of a write operation ($\overline{R/W}$ bit set to '0'). After the array address is sent, the master generates a Start condition following the Acknowledge. This terminates the write operation, but not before the Address Pointer has been set. Then, the master issues the SRAM control byte again, but with the $\overline{R/W}$ bit set to a '1'. The 47XXX will then issue an Acknowledge and transmit the 8-bit data byte. The master will not Acknowledge the transfer but does generate a Stop condition, which causes the 47XXX to discontinue transmission (Figure 2-7). After a random read operation, the Address Pointer will point to the address location following the one that was just read.

2.3.2.3 Sequential Read

Sequential reads are initiated in the same way as a random read, except that after the 47XXX transmits the first data byte, the master issues an Acknowledge as opposed to the Stop condition used in a random read. The Acknowledge directs the 47XXX to transmit the next sequentially addressed 8-bit byte (Figure 2-8). Following the final byte transmitted to the master, the master will NOT generate an Acknowledge but will generate a Stop condition. To provide sequential reads, the 47XXX increments the internal Address Pointer by one after the transfer of each data byte. This allows the entire memory contents to be serially read during one operation. The Address Pointer will automatically roll over at the end of the array to address 0x000 after the last data byte in the array has been transferred.

FIGURE 2-7: SRAM RANDOM READ



47L04/47C04/47L16/47C16

FIGURE 2-8: SRAM SEQUENTIAL READ



2.4 Control Registers

To support device configuration features such as software write protection, as well as software-controllable Store and Recall operations, the 47XXX features a set of Control registers that are accessed using a different 4-bit op code than the op code for the SRAM array (refer to [Table 2-3](#) for op code values).

Note: If an Auto-Store or Hardware Store is triggered during a Control register read or write operation, the operation is aborted in order to execute the Store.

[Table 2-4](#) lists the available Control registers. The STATUS register allows the user to configure the 47XXX. The COMMAND register is used to execute special Software commands.

Note: The COMMAND register is write-only.

TABLE 2-4: CONTROL REGISTERS

Register Name	Address	Bit 7	Bit 6	Bit 5	Bit 4	Bit 3	Bit 2	Bit 1	Bit 0
STATUS	00h	AM	—	—	BP2	BP1	BP0	ASE	EVENT
COMMAND	55h	CMD7	CMD6	CMD5	CMD4	CMD3	CMD2	CMD1	CMD0

2.4.1 STATUS REGISTER

The STATUS register controls the software write protection, enables/disables the Auto-Store function, reports whether or not the array has been modified since the last Store or Recall operation, and contains the Hardware Store event flag.

There are several bits contained within the STATUS register:

- The **AM** bit indicates whether or not the SRAM array has been written to since the last Store or Recall operation. When set to a '0', the SRAM array matches the data in the EEPROM array. When set to a '1', the SRAM array no longer matches the EEPROM array. The **AM** bit is set whenever a data byte is written to the SRAM, and is cleared after a Store or Recall operation is completed. The **AM** bit must be a '1' to enable the Auto-Store and Hardware Store functions. However, the Software Store command is always enabled. The **AM** bit is volatile and is read-only.
- The **BP** bits control the SRAM array software write protection. [Table 2-5](#) lists the address ranges that can be protected for each device. The **BP** bits are nonvolatile.
- The **ASE** bit determines whether or not the Auto-Store function is enabled. When set to a '1', the Auto-Store function is enabled and will execute automatically on power-down if the array has been modified. When set to a '0', the Auto-Store function is disabled. The **ASE** bit is nonvolatile.

Note: If a capacitor is not connected to the VCAP pin, then the VCAP pin must be connected to VCC and the Auto-Store feature must be disabled by writing the **ASE** bit to a '0' to prevent data corruption in the EEPROM array when power is lost.

- The **EVENT** bit indicates whether or not an external event has been detected on the HS pin. When the HS pin is driven high, a STATUS register write operation is automatically initiated following the Hardware Store operation to set this bit to a '1'. This bit can also be set and cleared through a STATUS register Write command. The **EVENT** bit is nonvolatile.

Note: The HS pin is ignored when VCAP is below VTRIP, and during Store and Recall operations. In these cases, the **EVENT** bit will not be written.

To store the nonvolatile bits in the STATUS register, a write cycle occurs after a STATUS register write operation, during which the 47XXX cannot be accessed for Twc time after the Stop condition.

Note: During a STATUS register write cycle, an Auto-Store or Hardware Store can still be triggered, but the Store operation will not execute until the STATUS register write cycle is complete ([Figure 2-13](#)). In this situation, the new value of the ASE bit will be used to determine if the Auto-Store is executed.

47L04/47C04/47L16/47C16

TABLE 2-5: PROTECTED ARRAY ADDRESS LOCATIONS

Protected Range	BP2	BP1	BP0	47X04	47X16
None	0	0	0	—	—
Upper 1/64	0	0	1	1F8h-1FFh	7E0h-7FFh
Upper 1/32	0	1	0	1F0h-1FFh	7C0h-7FFh
Upper 1/16	0	1	1	1E0h-1FFh	780h-7FFh
Upper 1/8	1	0	0	1C0h-1FFh	700h-7FFh
Upper 1/4	1	0	1	180h-1FFh	600h-7FFh
Upper 1/2	1	1	0	100h-1FFh	400h-7FFh
All Blocks	1	1	1	000h-1FFh	000h-7FFh

REGISTER 2-1: STATUS REGISTER

R-0	U-0	U-0	R/W	R/W	R/W	R/W	R/W
AM	—	—	BP2	BP1	BP0	ASE	EVENT
bit 7							bit 0

Legend:

R = Readable bit W = Writable bit U = Unimplemented bit, read as '0'
 -n = Value at POR '1' = Bit is set '0' = Bit is cleared x = Bit is unknown

- bit 7 **AM:** Array Modified bit
 1 = SRAM array has been modified
 0 = SRAM array has not been modified
- bit 6-5 **Unimplemented:** Read as '0'
- bit 4-2 **BP<2:0>:** Block Protect bits
 000 = Entire array is unprotected
 001 = Upper 1/64 of array is write-protected
 010 = Upper 1/32 of array is write-protected
 011 = Upper 1/16 of array is write-protected
 100 = Upper 1/8 of array is write-protected
 101 = Upper 1/4 of array is write-protected
 110 = Upper 1/2 of array is write-protected
 111 = Entire array is write-protected
- bit 1 **ASE:** Auto-Store Enable bit
 1 = Auto-Store feature is enabled
 0 = Auto-Store feature is disabled
- bit 0 **EVENT:** Event Detect bit
 1 = An event was detected on the HS pin
 0 = No event was detected on the HS pin

2.4.2 COMMAND REGISTER

The COMMAND register is a write-only register that allows the user to execute software-controlled Store and Recall operations. There are two commands that can be executed, as shown in Table 2-6:

- The Software Store command initiates a manual Store operation. The 47XXX cannot be accessed for TSTORE time after this command has been received. During this time, the 47XXX will not acknowledge any communication. The Software Store command will execute regardless of the state of the **AM** and **ASE** bits in the STATUS register. The **AM** bit will be cleared at the end of the Store operation.
- The Software Recall command initiates a manual Recall operation. The 47XXX cannot be accessed for TRECALL time after this command has been received.

During this time, the 47XXX will not acknowledge any communication. The **AM** bit will be cleared at the end of the Recall operation.

Note: If a capacitor is not connected to the VCAP pin, then the VCAP pin must be connected to VCC and the user must ensure that power is not lost during a Store operation, otherwise data corruption may occur.

TABLE 2-6: COMMAND SET

Command	Value	Description
Software Store	0011 0011	Store SRAM data to EEPROM
Software Recall	1101 1101	Recall data from EEPROM to SRAM

REGISTER 2-2: COMMAND REGISTER

W	W	W	W	W	W	W	W
CMD7	CMD6	CMD5	CMD4	CMD3	CMD2	CMD1	CMD0
bit 7							bit 0

Legend:

R = Readable bit W = Writable bit U = Unimplemented bit, read as '0'
 -n = Value at POR '1' = Bit is set '0' = Bit is cleared x = Bit is unknown

bit 7-0 **CMD<7:0>**: Command bits
 00110011 = Executes a Software Store command
 11011101 = Executes a Software Recall command

47L04/47C04/47L16/47C16

2.4.3 CONTROL REGISTER WRITE OPERATION

When the Control registers are selected and the $\overline{R/W}$ bit in the control byte is set to '0', a write operation is selected and the next byte received is interpreted as the register address. The Most Significant address bits are transferred first, followed by the less significant bits. The register address is decoded as soon as it is received and has no effect on future operations.

The register address must be a valid Control register address listed in Table 2-4, otherwise the 47XXX will not acknowledge the address, the current operation will be terminated, and any data transmitted on the SDA line will be ignored until a new operation is begun with a Start condition.

After receiving the Acknowledge signal from the 47XXX following the register address, the master will transmit the data byte to be written to the addressed register.

If the data byte is valid, the 47XXX acknowledges again and the master generates a Stop condition.

For a STATUS register write operation, any data byte value is valid. However, for COMMAND register write operations, only the commands listed in Table 2-6 are valid. If a different command value is received, the 47XXX will not acknowledge the command, the current operation will be terminated, and any data transmitted on the SDA line will be ignored until a new operation is begun with a Start condition.

- Note 1:** When writing to the COMMAND register, the master must send exactly one data byte. If additional data bytes are sent, then the 47XXX will not acknowledge the data bytes and will abort the operation.
- 2:** Multiple data bytes are allowed when writing to the STATUS register. The last data byte received will be written.

FIGURE 2-9: CONTROL REGISTER WRITE



2.4.4 CONTROL REGISTER READ OPERATION

When the Control registers are selected and the $\overline{R/W}$ bit in the control byte is set to '1', a read operation is selected. For read operations, the register address is not transmitted. Since the COMMAND register is write-only, all Control register read operations access the STATUS register.

During read operations, the master device generates the Acknowledge bit after each data byte, and it is this bit which determines whether the operation will continue or end. A '0' (Acknowledge) bit requests more data and continues the read, while a '1' (No Acknowledge) bit ends the read operation.

Upon receipt of the control byte with the $\overline{R/W}$ bit set to '1', the 47XXX issues an Acknowledge and transmits the 8-bit STATUS register value. The master will not acknowledge the transfer, but does generate a Stop condition and the 47XXX discontinues transmission (Figure 2-10).

FIGURE 2-10: CONTROL REGISTER READ



- Note:** If the master acknowledges the data byte, the 47XXX will retransmit the 8-bit STATUS register value.

2.5 STORE/RECALL OPERATIONS

In order to provide nonvolatile storage of the SRAM data, an EEPROM array is included on the 47XXX. The EEPROM array is not directly accessible to the user. Instead, data is written to and read from the EEPROM array using the various Store and Recall operations, respectively.

To provide design flexibility for the user, the 47XXX can automatically perform Store and Recall operations on power-down and power-up, respectively, and also offers Software commands and a Hardware Store pin for manual control.

Refer to [Section 2.4.2 “Command Register”](#) for details of the Software Store and Software Recall commands.

Note: Once a Store operation is initiated, it cannot be aborted.

2.5.1 AUTO-STORE

To simplify device usage, the 47XXX features an Auto-Store mechanism. To enable this feature, the user must place a capacitor on the VCAP pin and ensure the **ASE** bit in the STATUS register is set to ‘1’. The capacitor is charged through the Vcc pin. When the 47XXX detects a power-down event, the device automatically switches to the capacitor for power and initiates the Auto-Store operation.

The Auto-Store is initiated when VCAP falls below VTRIP. Even if power is restored, the 47XXX cannot be accessed for TSTORE time after the Auto-Store is initiated.

To avoid extraneous Store operations, the Auto-Store will only be initiated if the **AM** bit in the STATUS register is set to a ‘1’, indicating the SRAM array has been modified since the last Store or Recall operation.

The **AM** bit in the STATUS register is cleared at the completion of the Auto-Store operation.

2.5.2 HARDWARE STORE

The HS pin provides a method for manually initiating a Store operation through an external trigger. Driving the HS pin high for a minimum of THSPW time will initiate a Hardware Store operation if the **AM** bit in the STATUS register is a ‘1’.

Driving the HS pin high will also automatically initiate a STATUS register write cycle to write the **EVENT** bit to a ‘1’, regardless of the state of the **AM** bit.

If the **AM** bit is a ‘1’, the Hardware Store is initiated on the rising edge of the HS pin, and then the 47XXX cannot be accessed for (TSTORE + TWC) time. If the **AM** bit is a ‘0’, only the **EVENT** bit write is initiated on the rising edge of the HS pin, and then the 47XXX cannot be accessed for TWC time while the STATUS register is written.

The **AM** bit in the STATUS register is cleared at the completion of the Hardware Store operation.

Note 1: The HS pin is ignored during Store and Recall operations, or if VCAP is below VTRIP.

2: The HS pin is triggered on the rising edge. If the HS pin remains high after the Hardware Store and STATUS register write are complete, the device can still be accessed normally just as if the HS pin were low. Initiating a subsequent Hardware Store operation requires toggling HS low then high again.

2.5.3 AUTO-RECALL

The 47XXX features an Auto-Recall mechanism that is performed on power-up, regardless of the state of the **ASE** bit. This feature ensures that the SRAM data duplicates the EEPROM data on power-up. The Auto-Recall is only initiated the first time VCAP rises above VTRIP after a POR event, and the 47XXX cannot be accessed for TRECALLE time after the Auto-Recall is initiated.

The **AM** bit in the STATUS register is cleared at the completion of the Auto-Recall operation.

Note 1: If power is lost during an Auto-Recall operation, the Auto-Recall is aborted and the Auto-Store is not performed.

2: Auto-Recall is only performed the first time VCAP rises above VTRIP after a POR event. However, SRAM data will be retained as long as Vcc remains above VPOR.

TABLE 2-7: STORE ENABLE TRUTH TABLE

ASE Bit	AM Bit	Auto-Store Enabled	Hardware Store Enabled	Software Store Enabled	Auto-Recall Enabled	Software Recall Enabled
X	0	No	No	Yes	Yes	Yes
0	1	No	Yes	Yes	Yes	Yes
1	1	Yes	Yes	Yes	Yes	Yes

47L04/47C04/47L16/47C16

FIGURE 2-11: AUTO-STORE/AUTO-RECALL SCENARIOS (WITH ASE = 1, AM = 1)



FIGURE 2-12: AUTO-STORE/AUTO-RECALL SCENARIOS (WITH ASE = 0 OR AM = 0)

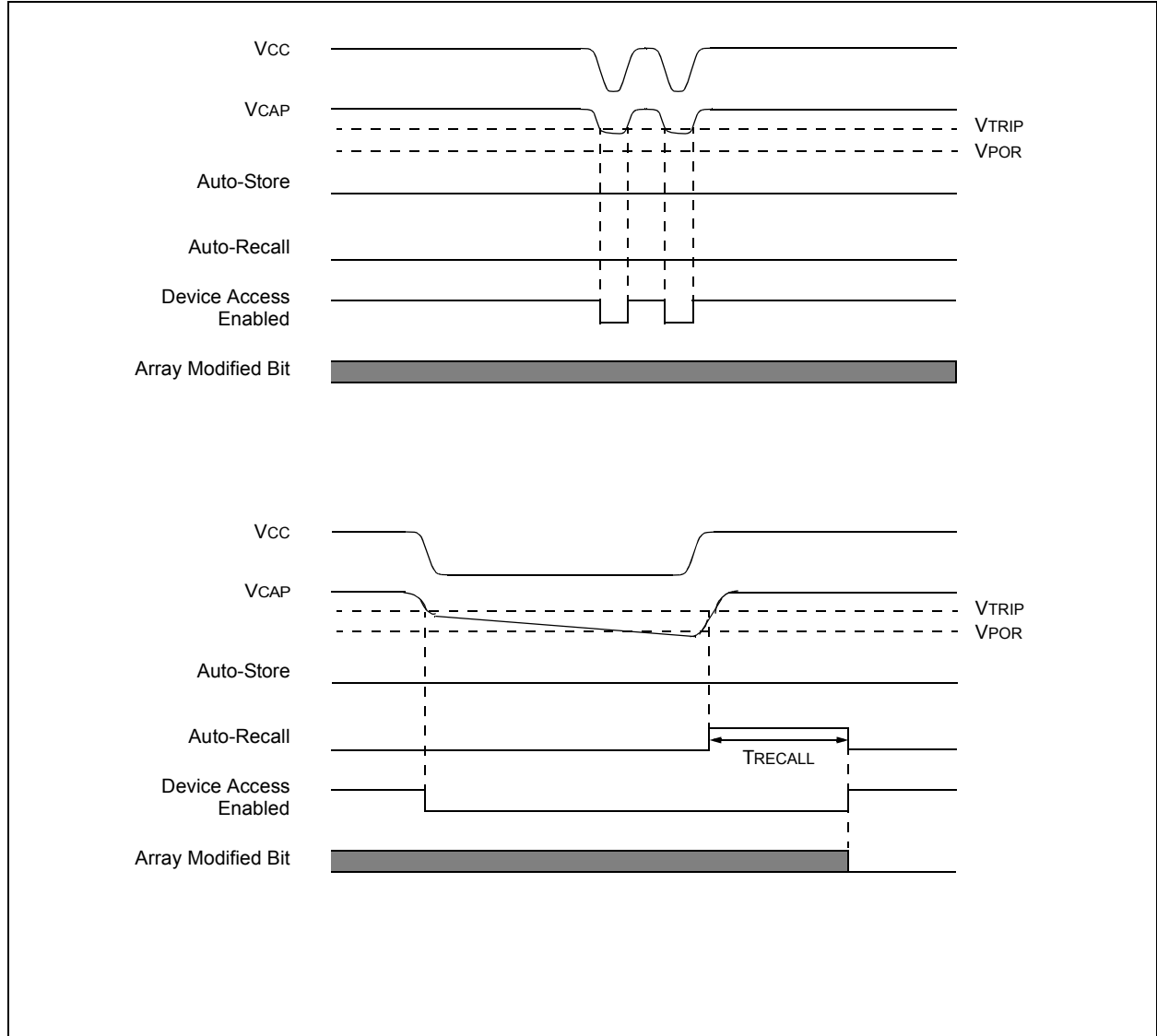

47L04/47C04/47L16/47C16

FIGURE 2-13: STORE DURING STATUS REGISTER WRITE CYCLE SCENARIOS (WITH AM = 1)

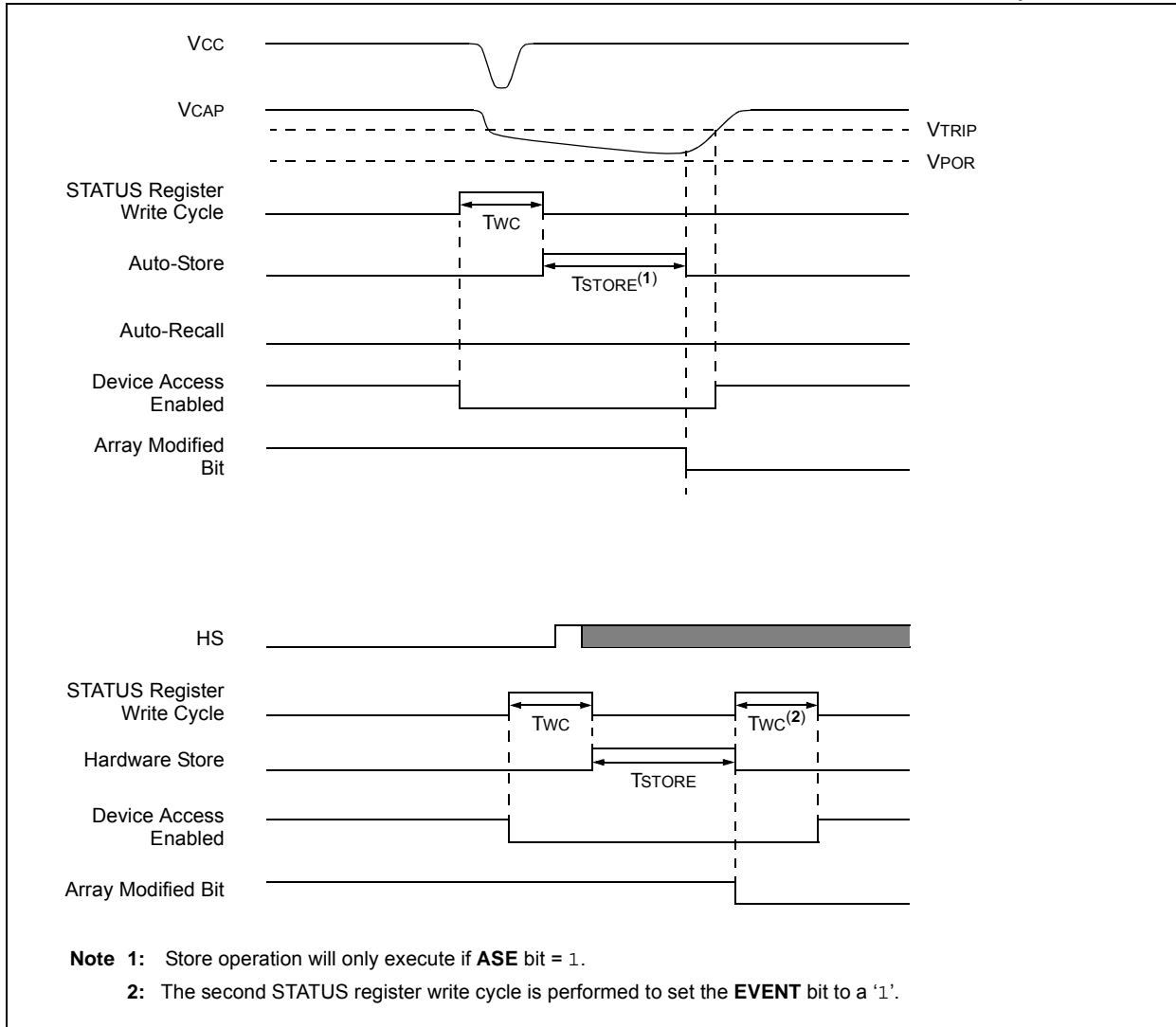
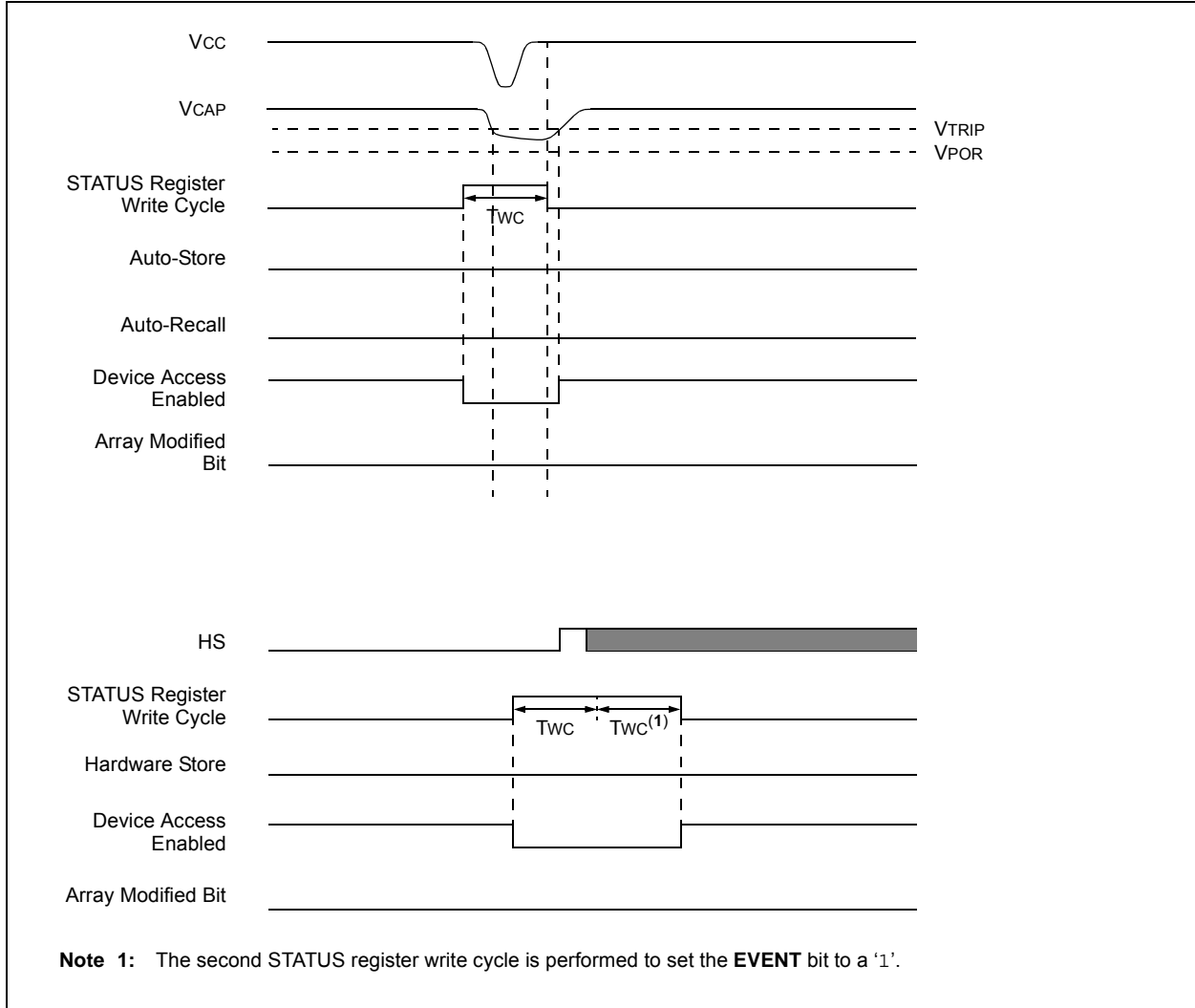

FIGURE 2-14: STORE DURING STATUS REGISTER WRITE CYCLE SCENARIOS (WITH AM = 0)



Note 1: The second STATUS register write cycle is performed to set the **EVENT** bit to a '1'.

2.6 ACKNOWLEDGE POLLING

Since the device will not acknowledge during Store and Recall operations, nor during the internal STATUS register write cycles, checking for the Acknowledge signal can be used to determine when those events are complete. Once such an event has started, Acknowledge polling can be initiated immediately. This involves the master sending a Start condition, followed by the write control byte ($R/\overline{W} = 0$) for either the SRAM array or the Control registers. If the device is still busy, then no Acknowledge will be returned. In this case, then the Start condition and control byte must be resent. If the Store or Recall is complete, then the device will return an Acknowledge, and the master can then proceed with the next Read or Write command. See Figure 2-15 for flow diagram.

FIGURE 2-15: ACKNOWLEDGE POLLING FLOW



3.0 PIN DESCRIPTIONS

The descriptions of the pins are listed in [Table 3-1](#).

TABLE 3-1: PIN FUNCTION TABLE

Name	8-pin PDIP SOIC TSSOP	Function
VCAP	1	Capacitor Input
A1	2	Chip Select Input
A2	3	Chip Select Input
Vss	4	Ground
SDA	5	Serial Data
SCL	6	Serial Clock
HS	7	Hardware Store/ Event Detect Input
VCC	8	Power Supply

3.1 Pin Descriptions

3.1.1 CAPACITOR INPUT (VCAP)

The VCAP pin is connected to the internal power bus of the 47XXX.

If the Auto-Store feature is used, a CVCAP capacitor must be connected to the VCAP pin in order to store the energy required to complete the Auto-Store operation on power-down. The capacitor is automatically charged through VCC. See [Table 1-1](#) for recommended CVCAP values.

If a capacitor is not connected to the VCAP pin, then the VCAP pin must be connected to the VCC pin and the Auto-Store feature must be disabled by writing the **ASE** bit in the STATUS register to a '0' to prevent data corruption in the EEPROM array when power is lost.

3.1.2 CHIP ADDRESS INPUTS (A1, A2)

The A1, A2 inputs are used by the 47XXX for multiple device operation. The levels on these inputs are compared with the corresponding Chip Select bits in the slave address. The chip is selected if the comparison is true.

Up to four devices may be connected to the same bus by using different Chip Select bit combinations. If left unconnected, these inputs will be pulled down internally to Vss.

3.1.3 SERIAL DATA (SDA)

This is a bidirectional pin used to transfer addresses and data into and data out of the device. It is an open-drain terminal, therefore, the SDA bus requires a pull-up resistor to Vcc (typical 10 kΩ for 100 kHz, 2 kΩ for 400 kHz and 1 MHz).

For normal data transfer SDA is allowed to change only during SCL low. Changes during SCL high are reserved for indicating the Start and Stop conditions.

3.1.4 SERIAL CLOCK (SCL)

This input is used to synchronize the data transfer from and to the device.

3.1.5 HARDWARE STORE/EVENT DETECT (HS)

This pin is used to initiate a Hardware Store operation by driving the pin high for THSPW time. This will also trigger a STATUS register write cycle to write the **EVENT** bit to a '1'.

This pin is ignored during Store and Recall operations, or if VCAP is below VTRIP. If the **AM** bit in the STATUS register is set to a '0', the Hardware Store will not be initiated, but the **EVENT** bit will still be written to a '1'.

If left unconnected, this input will be pulled down internally to Vss.

3.2 Input Pull-down Circuitry

The A1, A2, and HS pins are internally pulled down to Vss using dual-strength pull-down circuits. [Figure 3-1](#) shows the block diagram of the circuit.

The circuit is designed to have a relatively strong pull-down strength when the input voltage is below VIL, and a much weaker pull-down when the input is above VIH.

See [Table 1-1](#) for actual resistance values.

FIGURE 3-1: PULL-DOWN CIRCUIT BLOCK DIAGRAM



47L04/47C04/47L16/47C16

4.0 PACKAGING INFORMATION

4.1 Package Marking Information

8-Lead PDIP (300 mil)



Example



8-Lead SOIC (3.90 mm)



Example



8-Lead TSSOP

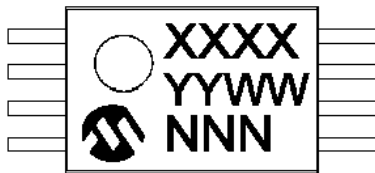

Example



Part Number	1st Line Marking Codes		
	PDIP	SOIC	TSSOP
47L04	47L04	47L04	AAAQ
47C04	47C04	47C04	AAAR
47L16	47L16	47L16	AAAS
47C16	47C16	47C16	AAAT

Legend: XX...X Customer-specific information
 YY Year code (last 2 digits of calendar year)
 WW Week code (week of January 1 is week '01')
 NNN Alphanumeric traceability code
 (e3) JEDEC® designator for Matte Tin (Sn)
 * This package is RoHS compliant. The JEDEC® designator ((e3)) can be found on the outer packaging for this package.

Note: In the event the full Microchip part number cannot be marked on one line, it will be carried over to the next line, thus limiting the number of available characters for customer-specific information.

47L04/47C04/47L16/47C16

8-Lead Plastic Dual In-Line (P) - 300 mil Body [PDIP]

Note: For the most current package drawings, please see the Microchip Packaging Specification located at <http://www.microchip.com/packaging>



Microchip Technology Drawing No. C04-018D Sheet 1 of 2

47L04/47C04/47L16/47C16

8-Lead Plastic Dual In-Line (P) - 300 mil Body [PDIP]

Note: For the most current package drawings, please see the Microchip Packaging Specification located at <http://www.microchip.com/packaging>

ALTERNATE LEAD DESIGN (VENDOR DEPENDENT)



Dimension Limits	Units	INCHES		
		MIN	NOM	MAX
Number of Pins	N	8		
Pitch	e	.100 BSC		
Top to Seating Plane	A	-	-	.210
Molded Package Thickness	A2	.115	.130	.195
Base to Seating Plane	A1	.015	-	-
Shoulder to Shoulder Width	E	.290	.310	.325
Molded Package Width	E1	.240	.250	.280
Overall Length	D	.348	.365	.400
Tip to Seating Plane	L	.115	.130	.150
Lead Thickness	c	.008	.010	.015
Upper Lead Width	b1	.040	.060	.070
Lower Lead Width	b	.014	.018	.022
Overall Row Spacing §	eB	-	-	.430

Notes:

1. Pin 1 visual index feature may vary, but must be located within the hatched area.
2. § Significant Characteristic
3. Dimensions D and E1 do not include mold flash or protrusions. Mold flash or protrusions shall not exceed .010" per side.
4. Dimensioning and tolerancing per ASME Y14.5M

BSC: Basic Dimension. Theoretically exact value shown without tolerances.

Microchip Technology Drawing No. C04-018D Sheet 2 of 2

47L04/47C04/47L16/47C16

8-Lead Plastic Small Outline (SN) - Narrow, 3.90 mm Body [SOIC]

Note: For the most current package drawings, please see the Microchip Packaging Specification located at <http://www.microchip.com/packaging>



Microchip Technology Drawing No. C04-057C Sheet 1 of 2

47L04/47C04/47L16/47C16

8-Lead Plastic Small Outline (SN) - Narrow, 3.90 mm Body [SOIC]

Note: For the most current package drawings, please see the Microchip Packaging Specification located at <http://www.microchip.com/packaging>



		Units	MILLIMETERS		
Dimension Limits			MIN	NOM	MAX
Number of Pins	N		8		
Pitch	e		1.27 BSC		
Overall Height	A		-	-	1.75
Molded Package Thickness	A2		1.25	-	-
Standoff §	A1		0.10	-	0.25
Overall Width	E		6.00 BSC		
Molded Package Width	E1		3.90 BSC		
Overall Length	D		4.90 BSC		
Chamfer (Optional)	h		0.25	-	0.50
Foot Length	L		0.40	-	1.27
Footprint	L1		1.04 REF		
Foot Angle	φ		0°	-	8°
Lead Thickness	c		0.17	-	0.25
Lead Width	b		0.31	-	0.51
Mold Draft Angle Top	α		5°	-	15°
Mold Draft Angle Bottom	β		5°	-	15°

Notes:

1. Pin 1 visual index feature may vary, but must be located within the hatched area.
2. § Significant Characteristic
3. Dimensions D and E1 do not include mold flash or protrusions. Mold flash or protrusions shall not exceed 0.15mm per side.
4. Dimensioning and tolerancing per ASME Y14.5M

BSC: Basic Dimension. Theoretically exact value shown without tolerances.

REF: Reference Dimension, usually without tolerance, for information purposes only.

Microchip Technology Drawing No. C04-057C Sheet 2 of 2

47L04/47C04/47L16/47C16

8-Lead Plastic Small Outline (SN) – Narrow, 3.90 mm Body [SOIC]

Note: For the most current package drawings, please see the Microchip Packaging Specification located at <http://www.microchip.com/packaging>



RECOMMENDED LAND PATTERN

Dimension Limits	Units	MILLIMETERS		
		MIN	NOM	MAX
Contact Pitch	E	1.27 BSC		
Contact Pad Spacing	C		5.40	
Contact Pad Width (X8)	X1			0.60
Contact Pad Length (X8)	Y1			1.55

Notes:

1. Dimensioning and tolerancing per ASME Y14.5M

BSC: Basic Dimension. Theoretically exact value shown without tolerances.

Microchip Technology Drawing No. C04-2057A

47L04/47C04/47L16/47C16

8-Lead Plastic Thin Shrink Small Outline (ST) – 4.4 mm Body [TSSOP]

Note: For the most current package drawings, please see the Microchip Packaging Specification located at <http://www.microchip.com/packaging>



Dimension Limits	Units	MILLIMETERS		
		MIN	NOM	MAX
Number of Pins	N	8		
Pitch	e	0.65 BSC		
Overall Height	A	–	–	1.20
Molded Package Thickness	A2	0.80	1.00	1.05
Standoff	A1	0.05	–	0.15
Overall Width	E	6.40 BSC		
Molded Package Width	E1	4.30	4.40	4.50
Molded Package Length	D	2.90	3.00	3.10
Foot Length	L	0.45	0.60	0.75
Footprint	L1	1.00 REF		
Foot Angle	ϕ	0°	–	8°
Lead Thickness	c	0.09	–	0.20
Lead Width	b	0.19	–	0.30

Notes:

- Pin 1 visual index feature may vary, but must be located within the hatched area.
- Dimensions D and E1 do not include mold flash or protrusions. Mold flash or protrusions shall not exceed 0.15 mm per side.
- Dimensioning and tolerancing per ASME Y14.5M.

BSC: Basic Dimension. Theoretically exact value shown without tolerances.

REF: Reference Dimension, usually without tolerance, for information purposes only.

Microchip Technology Drawing C04-086B

47L04/47C04/47L16/47C16

8-Lead Plastic Thin Shrink Small Outline (ST) - 4.4 mm Body [TSSOP]

Note: For the most current package drawings, please see the Microchip Packaging Specification located at <http://www.microchip.com/packaging>



RECOMMENDED LAND PATTERN

Units		MILLIMETERS		
Dimension Limits		MIN	NOM	MAX
Contact Pitch	E		0.65 BSC	
Contact Pad Spacing	C1		5.90	
Contact Pad Width (X8)	X1			0.45
Contact Pad Length (X8)	Y1			1.45
Distance Between Pads	G	0.20		

Notes:

1. Dimensioning and tolerancing per ASME Y14.5M

BSC: Basic Dimension, Theoretically exact value shown without tolerances.

Microchip Technology Drawing No. C04-2086A

APPENDIX A: REVISION HISTORY

Revision A (January 2015)

Initial release of the document.

Revision B (July 2016)

Removed Advance Information status; Updated AC/DC Characteristics table; Minor typographical corrections.

Revision C (October 2016)

Updated AC/DC parameters with final limits.

THE MICROCHIP WEBSITE

Microchip provides online support via our website at www.microchip.com. This website is used as a means to make files and information easily available to customers. Accessible by using your favorite Internet browser, the website contains the following information:

- **Product Support** – Data sheets and errata, application notes and sample programs, design resources, user's guides and hardware support documents, latest software releases and archived software
- **General Technical Support** – Frequently Asked Questions (FAQ), technical support requests, online discussion groups, Microchip consultant program member listing
- **Business of Microchip** – Product selector and ordering guides, latest Microchip press releases, listing of seminars and events, listings of Microchip sales offices, distributors and factory representatives

CUSTOMER CHANGE NOTIFICATION SERVICE

Microchip's customer notification service helps keep customers current on Microchip products. Subscribers will receive e-mail notification whenever there are changes, updates, revisions or errata related to a specified product family or development tool of interest.

To register, access the Microchip website at www.microchip.com. Under "Support", click on "Customer Change Notification" and follow the registration instructions.

CUSTOMER SUPPORT

Users of Microchip products can receive assistance through several channels:

- Distributor or Representative
- Local Sales Office
- Field Application Engineer (FAE)
- Technical Support

Customers should contact their distributor, representative or Field Application Engineer (FAE) for support. Local sales offices are also available to help customers. A listing of sales offices and locations is included in the back of this document.

Technical support is available through the website at: <http://www.microchip.com/support>

47L04/47C04/47L16/47C16

NOTES:

47L04/47C04/47L16/47C16

PRODUCT IDENTIFICATION SYSTEM

To order or obtain information, e.g., on pricing or delivery, refer to the factory or the listed sales office.

<u>PART NO.</u>	<u>[X]⁽¹⁾</u>	<u>X</u>	<u>/XX</u>	Examples:
Device	Tape & Reel Option	Temp. Range	Package	
Device:	47L04:	4 Kbit, 3V SRAM with EEPROM backup		a) 47L04-E/P: 4 Kbit Extended Temperature, 3V, 8-LD PDIP package.
	47C04:	4 Kbit, 5V SRAM with EEPROM backup		b) 47L04-E/SN: 4 Kbit Extended Temperature, 3V, 8-LD SOIC package.
	47L16:	16 Kbit, 3V SRAM with EEPROM backup		c) 47L04-I/ST: 4 Kbit Industrial Temperature, 3V, 8-LD TSSOP package.
	47C16:	16 Kbit, 5V SRAM with EEPROM backup		d) 47L04T-E/SN: Tape and Reel, 4 Kbit Extended Temperature, 3V, 8-LD SOIC package.
Tape and Reel Option:	Blank	= Standard packaging (tube or tray)		e) 47L04T-I/ST: Tape and Reel, 4 Kbit Industrial Temperature, 3V, 8-LD TSSOP package.
	T	= Tape & Reel		a) 47C04-E/P: 4 Kbit Extended Temperature, 5V, 8-LD PDIP package.
Temperature Range:	I	= -40°C to +85°C		b) 47C04-E/SN: 4 Kbit Extended Temperature, 5V, 8-LD SOIC package.
	E	= -40°C to +125°C		c) 47C04-I/ST: 4 Kbit Industrial Temperature, 5V, 8-LD TSSOP package.
Package:	P	= Plastic DIP (300 mil body), 8-lead		d) 47C04T-E/SN: Tape and Reel, 4 Kbit Extended Temperature, 5V, 8-LD SOIC package.
	SN	= Plastic SOIC (3.90 mm body), 8-lead		e) 47C04T-I/ST: Tape and Reel, 4 Kbit Industrial Temperature, 5V, 8-LD TSSOP package.
	ST	= Plastic TSSOP (4.4 mm), 8-lead		a) 47L16-E/P: 16 Kbit Extended Temperature, 3V 8-LD PDIP package.
				b) 47L16-E/SN: 16 Kbit Extended Temperature, 3V 8-LD SOIC package.
				c) 47L16-I/ST: 16 Kbit Industrial Temperature, 3V 8-LD TSSOP package.
				d) 47L16T-E/SN: Tape and Reel, 16 Kbit Extended Temperature, 3V 8-LD SOIC package.
				e) 47L16T-I/ST: Tape and Reel, 16 Kbit Industrial Temperature, 3V 8-LD TSSOP package.
				a) 47C16-E/P: 16 Kbit Extended Temperature, 5V, 8-LD PDIP package.
				b) 47C16-E/SN: 16 Kbit Extended Temperature, 5V, 8-LD SOIC package.
				c) 47C16-I/ST: 16 Kbit Industrial Temperature, 5V, 8-LD TSSOP package.
				d) 47C16T-E/SN: Tape and Reel, 16 Kbit Extended Temperature, 5V, 8-LD SOIC package.
				e) 47C16T-I/ST: Tape and Reel, 16 Kbit Industrial Temperature, 5V, 8-LD TSSOP package.
				Note 1: Tape and Reel identifier only appears in the catalog part number description. This identifier is used for ordering purposes and is not printed on the device package. Check with your Microchip Sales Office for package availability with the Tape and Reel option.

47L04/47C04/47L16/47C16

NOTES:

Note the following details of the code protection feature on Microchip devices:

- Microchip products meet the specification contained in their particular Microchip Data Sheet.
- Microchip believes that its family of products is one of the most secure families of its kind on the market today, when used in the intended manner and under normal conditions.
- There are dishonest and possibly illegal methods used to breach the code protection feature. All of these methods, to our knowledge, require using the Microchip products in a manner outside the operating specifications contained in Microchip's Data Sheets. Most likely, the person doing so is engaged in theft of intellectual property.
- Microchip is willing to work with the customer who is concerned about the integrity of their code.
- Neither Microchip nor any other semiconductor manufacturer can guarantee the security of their code. Code protection does not mean that we are guaranteeing the product as “unbreakable.”

Code protection is constantly evolving. We at Microchip are committed to continuously improving the code protection features of our products. Attempts to break Microchip's code protection feature may be a violation of the Digital Millennium Copyright Act. If such acts allow unauthorized access to your software or other copyrighted work, you may have a right to sue for relief under that Act.

Information contained in this publication regarding device applications and the like is provided only for your convenience and may be superseded by updates. It is your responsibility to ensure that your application meets with your specifications. MICROCHIP MAKES NO REPRESENTATIONS OR WARRANTIES OF ANY KIND WHETHER EXPRESS OR IMPLIED, WRITTEN OR ORAL, STATUTORY OR OTHERWISE, RELATED TO THE INFORMATION, INCLUDING BUT NOT LIMITED TO ITS CONDITION, QUALITY, PERFORMANCE, MERCHANTABILITY OR FITNESS FOR PURPOSE. Microchip disclaims all liability arising from this information and its use. Use of Microchip devices in life support and/or safety applications is entirely at the buyer's risk, and the buyer agrees to defend, indemnify and hold harmless Microchip from any and all damages, claims, suits, or expenses resulting from such use. No licenses are conveyed, implicitly or otherwise, under any Microchip intellectual property rights unless otherwise stated.

Microchip received ISO/TS-16949:2009 certification for its worldwide headquarters, design and wafer fabrication facilities in Chandler and Tempe, Arizona; Gresham, Oregon and design centers in California and India. The Company's quality system processes and procedures are for its PIC® MCUs and dsPIC® DSCs, KEELoC® code hopping devices, Serial EEPROMs, microperipherals, nonvolatile memory and analog products. In addition, Microchip's quality system for the design and manufacture of development systems is ISO 9001:2000 certified.

**QUALITY MANAGEMENT SYSTEM
CERTIFIED BY DNV
= ISO/TS 16949 =**

Trademarks

The Microchip name and logo, the Microchip logo, AnyRate, dsPIC, FlashFlex, flexPWR, Heldo, JukeBlox, KeeLoq, KeeLoq logo, Klear, LANCheck, LINK MD, MediaLB, MOST, MOST logo, MPLAB, OptoLyzer, PIC, PICSTART, PIC32 logo, RightTouch, SpyNIC, SST, SST Logo, SuperFlash and UNI/O are registered trademarks of Microchip Technology Incorporated in the U.S.A. and other countries.

ClockWorks, The Embedded Control Solutions Company, ETHERSYNCH, Hyper Speed Control, HyperLight Load, IntelliMOS, mTouch, Precision Edge, and QUIET-WIRE are registered trademarks of Microchip Technology Incorporated in the U.S.A.

Analog-for-the-Digital Age, Any Capacitor, AnyIn, AnyOut, BodyCom, chipKIT, chipKIT logo, CodeGuard, dsPICDEM, dsPICDEM.net, Dynamic Average Matching, DAM, ECAN, EtherGREEN, In-Circuit Serial Programming, ICSP, Inter-Chip Connectivity, JitterBlocker, KlearNet, KlearNet logo, MiWi, motorBench, MPASM, MPF, MPLAB Certified logo, MPLIB, MPLINK, MultiTRAK, NetDetach, Omniscient Code Generation, PICDEM, PICDEM.net, PICkit, PICtail, PureSilicon, RightTouch logo, REAL ICE, Ripple Blocker, Serial Quad I/O, SQL, SuperSwitcher, SuperSwitcher II, Total Endurance, TSHARC, USBCheck, VariSense, ViewSpan, WiperLock, Wireless DNA, and ZENA are trademarks of Microchip Technology Incorporated in the U.S.A. and other countries.

SQTP is a service mark of Microchip Technology Incorporated in the U.S.A.

Silicon Storage Technology is a registered trademark of Microchip Technology Inc. in other countries.

GestIC is a registered trademark of Microchip Technology Germany II GmbH & Co. KG, a subsidiary of Microchip Technology Inc., in other countries.

All other trademarks mentioned herein are property of their respective companies.

© 2015-2016, Microchip Technology Incorporated, Printed in the U.S.A., All Rights Reserved.

ISBN: 978-1-5224-1002-7



MICROCHIP

Worldwide Sales and Service

AMERICAS

Corporate Office

2355 West Chandler Blvd.
Chandler, AZ 85224-6199

Tel: 480-792-7200

Fax: 480-792-7277

Technical Support:

[http://www.microchip.com/
support](http://www.microchip.com/support)

Web Address:

www.microchip.com

Atlanta

Duluth, GA

Tel: 678-957-9614

Fax: 678-957-1455

Austin, TX

Tel: 512-257-3370

Boston

Westborough, MA

Tel: 774-760-0087

Fax: 774-760-0088

Chicago

Itasca, IL

Tel: 630-285-0071

Fax: 630-285-0075

Cleveland

Independence, OH

Tel: 216-447-0464

Fax: 216-447-0643

Dallas

Addison, TX

Tel: 972-818-7423

Fax: 972-818-2924

Detroit

Novi, MI

Tel: 248-848-4000

Houston, TX

Tel: 281-894-5983

Indianapolis

Noblesville, IN

Tel: 317-773-8323

Fax: 317-773-5453

Los Angeles

Mission Viejo, CA

Tel: 949-462-9523

Fax: 949-462-9608

New York, NY

Tel: 631-435-6000

San Jose, CA

Tel: 408-735-9110

Canada - Toronto

Tel: 905-695-1980

Fax: 905-695-2078

ASIA/PACIFIC

Asia Pacific Office

Suites 3707-14, 37th Floor
Tower 6, The Gateway
Harbour City, Kowloon

Hong Kong

Tel: 852-2943-5100

Fax: 852-2401-3431

Australia - Sydney

Tel: 61-2-9868-6733

Fax: 61-2-9868-6755

China - Beijing

Tel: 86-10-8569-7000

Fax: 86-10-8528-2104

China - Chengdu

Tel: 86-28-8665-5511

Fax: 86-28-8665-7889

China - Chongqing

Tel: 86-23-8980-9588

Fax: 86-23-8980-9500

China - Dongguan

Tel: 86-769-8702-9880

China - Guangzhou

Tel: 86-20-8755-8029

China - Hangzhou

Tel: 86-571-8792-8115

Fax: 86-571-8792-8116

China - Hong Kong SAR

Tel: 852-2943-5100

Fax: 852-2401-3431

China - Nanjing

Tel: 86-25-8473-2460

Fax: 86-25-8473-2470

China - Qingdao

Tel: 86-532-8502-7355

Fax: 86-532-8502-7205

China - Shanghai

Tel: 86-21-5407-5533

Fax: 86-21-5407-5066

China - Shenyang

Tel: 86-24-2334-2829

Fax: 86-24-2334-2393

China - Shenzhen

Tel: 86-755-8864-2200

Fax: 86-755-8203-1760

China - Wuhan

Tel: 86-27-5980-5300

Fax: 86-27-5980-5118

China - Xian

Tel: 86-29-8833-7252

Fax: 86-29-8833-7256

ASIA/PACIFIC

China - Xiamen

Tel: 86-592-2388138

Fax: 86-592-2388130

China - Zhuhai

Tel: 86-756-3210040

Fax: 86-756-3210049

India - Bangalore

Tel: 91-80-3090-4444

Fax: 91-80-3090-4123

India - New Delhi

Tel: 91-11-4160-8631

Fax: 91-11-4160-8632

India - Pune

Tel: 91-20-3019-1500

Japan - Osaka

Tel: 81-6-6152-7160

Fax: 81-6-6152-9310

Japan - Tokyo

Tel: 81-3-6880-3770

Fax: 81-3-6880-3771

Korea - Daegu

Tel: 82-53-744-4301

Fax: 82-53-744-4302

Korea - Seoul

Tel: 82-2-554-7200

Fax: 82-2-558-5932 or

82-2-558-5934

Malaysia - Kuala Lumpur

Tel: 60-3-6201-9857

Fax: 60-3-6201-9859

Malaysia - Penang

Tel: 60-4-227-8870

Fax: 60-4-227-4068

Philippines - Manila

Tel: 63-2-634-9065

Fax: 63-2-634-9069

Singapore

Tel: 65-6334-8870

Fax: 65-6334-8850

Taiwan - Hsin Chu

Tel: 886-3-5778-366

Fax: 886-3-5770-955

Taiwan - Kaohsiung

Tel: 886-7-213-7828

Taiwan - Taipei

Tel: 886-2-2508-8600

Fax: 886-2-2508-0102

Thailand - Bangkok

Tel: 66-2-694-1351

Fax: 66-2-694-1350

EUROPE

Austria - Wels

Tel: 43-7242-2244-39

Fax: 43-7242-2244-393

Denmark - Copenhagen

Tel: 45-4450-2828

Fax: 45-4485-2829

France - Paris

Tel: 33-1-69-53-63-20

Fax: 33-1-69-30-90-79

Germany - Dusseldorf

Tel: 49-2129-3766400

Germany - Karlsruhe

Tel: 49-721-625370

Germany - Munich

Tel: 49-89-627-144-0

Fax: 49-89-627-144-44

Italy - Milan

Tel: 39-0331-742611

Fax: 39-0331-466781

Italy - Venice

Tel: 39-049-7625286

Netherlands - Drunen

Tel: 31-416-690399

Fax: 31-416-690340

Poland - Warsaw

Tel: 48-22-3325737

Spain - Madrid

Tel: 34-91-708-08-90

Fax: 34-91-708-08-91

Sweden - Stockholm

Tel: 46-8-5090-4654

UK - Wokingham

Tel: 44-118-921-5800

Fax: 44-118-921-5820

06/23/16

Mouser Electronics

Authorized Distributor

Click to View Pricing, Inventory, Delivery & Lifecycle Information:

Microchip:

[47C04-E/P](#) [47C04-E/SN](#) [47C04-E/ST](#) [47C04-I/P](#) [47C04-I/SN](#) [47C04-I/ST](#) [47L16T-I/SN](#) [47L16T-I/ST](#) [47L16-E/ST](#)
[47L16-I/P](#) [47L16-I/SN](#) [47L16-I/ST](#) [47L16T-E/SN](#) [47L16T-E/ST](#) [47L04-I/SN](#) [47L04-I/ST](#) [47L04T-E/SN](#) [47L04T-](#)
[E/ST](#) [47L04T-I/SN](#) [47L04T-I/ST](#) [47C16T-I/SN](#) [47C16T-I/ST](#) [47L04-E/P](#) [47L04-E/SN](#) [47L04-E/ST](#) [47L04-I/P](#)
[47C16-E/ST](#) [47C16-I/P](#) [47C16-I/SN](#) [47C16-I/ST](#) [47C16T-E/SN](#) [47C16T-E/ST](#) [47C04T-E/SN](#) [47C04T-E/ST](#)
[47C04T-I/SN](#) [47C04T-I/ST](#) [47C16-E/P](#) [47C16-E/SN](#) [47L16-E/SN](#)

Компания «Life Electronics» занимается поставками электронных компонентов импортного и отечественного производства от производителей и со складов крупных дистрибьюторов Европы, Америки и Азии.

С конца 2013 года компания активно расширяет линейку поставок компонентов по направлению коаксиальный кабель, кварцевые генераторы и конденсаторы (керамические, пленочные, электролитические), за счёт заключения дистрибьюторских договоров

Мы предлагаем:

- Конкурентоспособные цены и скидки постоянным клиентам.
- Специальные условия для постоянных клиентов.
- Подбор аналогов.
- Поставку компонентов в любых объемах, удовлетворяющих вашим потребностям.
- Приемлемые сроки поставки, возможна ускоренная поставка.
- Доставку товара в любую точку России и стран СНГ.
- Комплексную поставку.
- Работу по проектам и поставку образцов.
- Формирование склада под заказчика.
- Сертификаты соответствия на поставляемую продукцию (по желанию клиента).
- Тестирование поставляемой продукции.
- Поставку компонентов, требующих военную и космическую приемку.
- Входной контроль качества.
- Наличие сертификата ISO.

В составе нашей компании организован Конструкторский отдел, призванный помогать разработчикам, и инженерам.

Конструкторский отдел помогает осуществить:

- Регистрацию проекта у производителя компонентов.
- Техническую поддержку проекта.
- Защиту от снятия компонента с производства.
- Оценку стоимости проекта по компонентам.
- Изготовление тестовой платы монтаж и пусконаладочные работы.



Тел: +7 (812) 336 43 04 (многоканальный)

Email: org@lifeelectronics.ru