

HALL EFFECT SINGLE AXIS PADDLE

HPW
HALL EFFECT
PADDLE

ONE MILLION CYCLE ROTATIONAL LIFE



Paddle Style



Lever Style

The HPW series is available with eight output options. The HPW series offers a self-centering single axis actuator that provides linear change in voltage output in either direction from center. Options include increasing or decreasing voltage output in either direction from center position to the full travel position in either direction, and single or dual outputs in either direction. The HPW series provides a one million cycle full forward to full back life and the electronics are sealed to IP68S, all the while offering outstanding EMI/RFI immunity.

Features:

- Designed for grip, armrest & panel mounting
- Proven contactless analog output Hall effect technology
- 8 output options available
- Self-centering, single axis actuator
- 1,000,000 mechanical life
- Electronics watertight to IP68S
- 100V/M EMI/RFI immunity
- RoHS/WEEE/Reach compliant

| Standard Characteristics/Ratings: | | | | |
|---|---|-------|-----|-------|
| MECHANICAL: | | | | |
| Mechanical Life: | 1,000,000 full forward to full back | | | |
| Travel: | Full travel angle each direction from center to 25° typical | | | |
| Operating Force: | 4 oz typical @ 25° | | | |
| Max Allowable Radial Load: | 30.0 lbs. | | | |
| ELECTRICAL RATINGS: Vcc = 5V @ 25°C Load = 1mA (4.7KΩ) | | | | |
| Electrical | Units | Min | Typ | Max |
| Supply Voltage | VDC | 4.5 | 5 | 5.5 |
| Output Voltage Tolerance at Center (see graph for output values) | VDC @ 5V Vcc | -0.25 | N/A | +0.25 |
| Output Voltage Tolerance at Full Travel (see graph for output values) | VDC @ 5V Vcc | -0.25 | N/A | +0.25 |
| Supply Current Options A & D (B = 0, Vcc = 5V, Io = 0) | mA | N/A | 8 | 10 |
| Supply Current All Other Options (B = 0, Vcc = 5V, Io = 0) | mA | N/A | 16 | 20 |
| ENVIRONMENTAL: | | | | |
| Operating Temp Range: | -40°C min to +85°C max | | | |
| Humidity: | 96% RH, 70°C, 96 hours | | | |
| Vibration: | Per MIL-DTL-810F minimum integrity | | | |
| Sand/Dust: | Per SAE J1455 | | | |
| Seal Integrity: | Electronics watertight per IP68S | | | |
| EMI: | Withstand per MIL-STD-461D/SAE J1113-22 | | | |
| RFI: | Withstand 100 V/M, 14Hz to 1GHz | | | |

HPW PART NUMBER CODE

| HPW | - | X | X | X | X | X | X |
|-----------------|-------------------|----------------|-----------------|-------------------------------------|-------------|--------------|---|
| Button Style | Output 1* | Output 2** | Operating Force | Termination | Bezel Color | Button Color | |
| 1. Paddle Style | A. 2.5 +/- 2.0VDC | NONE | 1.4.0 oz | A. 22 AWG 18.3" Long, Stripped Ends | 1. Red | 1. Red | |
| 2. Lever Style | B. 2.5 +/- 2.0VDC | 2.5 +/- 2.0VDC | | B. 0.025" SQ. Pins, Tin Plated | 2. Black | 2. Black | |
| | C. 2.5 +/- 2.0VDC | 2.5 +/- 2.0VDC | | | 3. Orange | 3. Orange | |
| | D. 2.5 +/- 1.5VDC | NONE | | | 4. Yellow | 4. Yellow | |
| | E. 2.5 +/- 1.5VDC | 2.5 +/- 1.5VDC | | | 5. Green | 5. Green | |
| | F. 2.5 +/- 1.5VDC | 2.5 +/- 1.5VDC | | | 6. Blue | 6. Blue | |
| | G. 1.0 - 4.0VDC | 1.0 - 4.0VDC | | | 7. Violet | 7. Violet | |
| | H. 0.5 - 4.5VDC | 0.5 - 4.5VDC | | | 8. Gray | 8. Gray | |
| | | | | | 9. White | 9. White | |

* Outputs are from the center position to the full travel position in each direction. Options A–F provide increasing voltage in Direction 1 and decreasing voltage in Direction 2 from a single output. Options G and H provide increasing voltages in both directions from two separate outputs.

** Options B and E provide redundant output 2 which duplicates output 1. Options C and F provide redundant output 2 which is inverse of output 1.

HALL EFFECT SINGLE AXIS PADDLE

ONE MILLION CYCLE ROTATIONAL LIFE

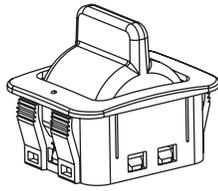

PADDLE STYLE

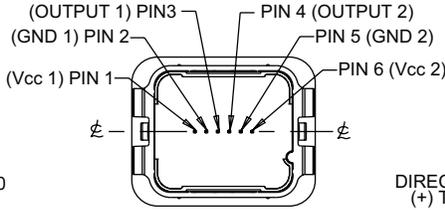
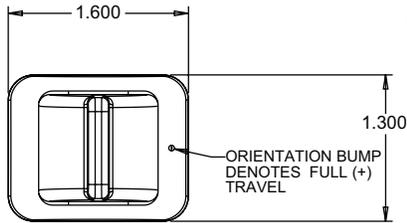
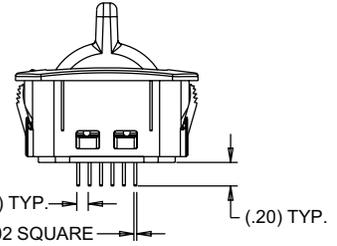

PINNED TERMINATION
NOT ALL PINS ARE PRESENT
IN ALL OUTPUT CONFIGURATIONS

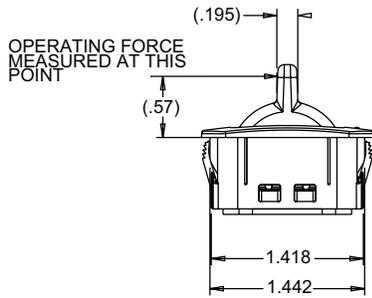
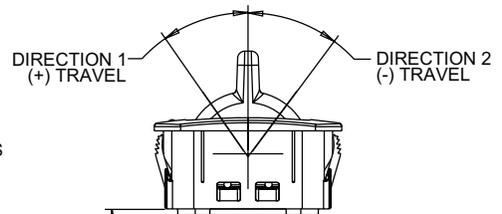

OPERATING FORCE
MEASURED AT THIS
POINT

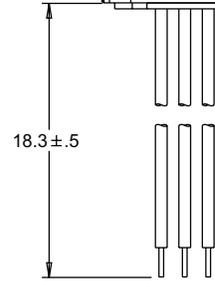
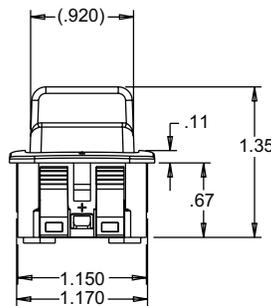

WIRED TERMINATION
NOT ALL WIRES ARE PRESENT
IN ALL OUTPUT CONFIGURATIONS

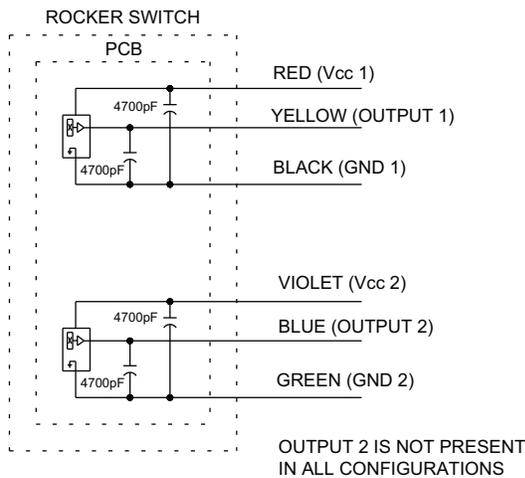

RECOMMENDED PANEL THICKNESS: 0.100 OPTIMUM THICKNESS
(0.065 MIN. - 0.175 MAX.)

RECOMMENDED PANEL OPENING: 1.180 X 1.480 OPTIMUM
(1.175/1.185 X 1.475/1.485)

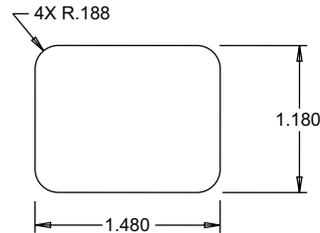

HALL EFFECT SINGLE AXIS PADDLE

HPW
HALL EFFECT
PADDLE

ONE MILLION CYCLE ROTATIONAL LIFE

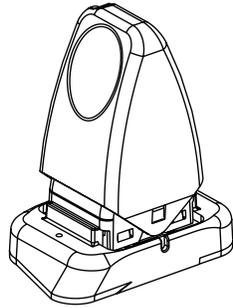

LEVER STYLE

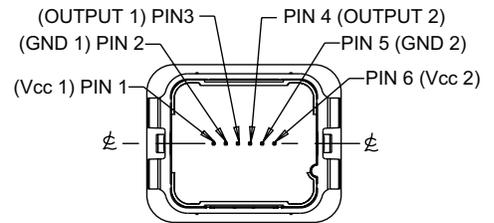
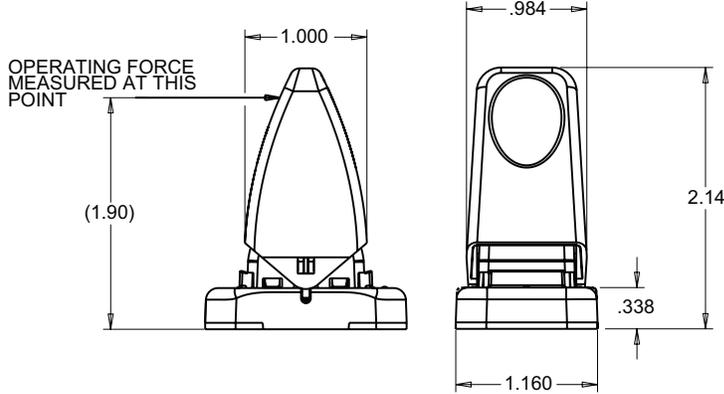
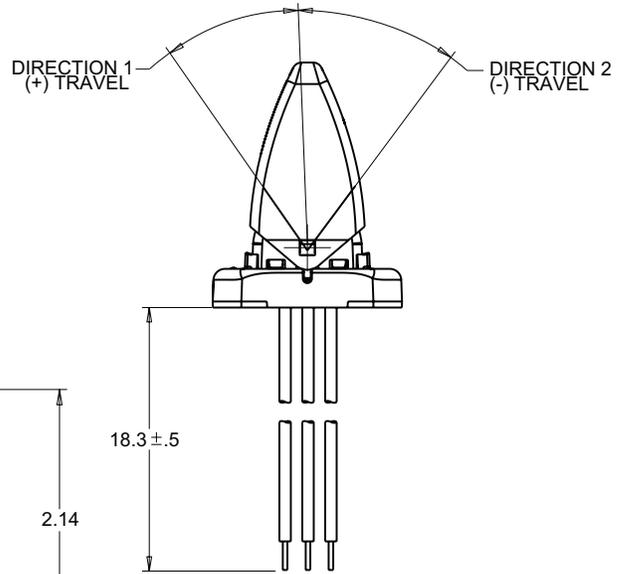
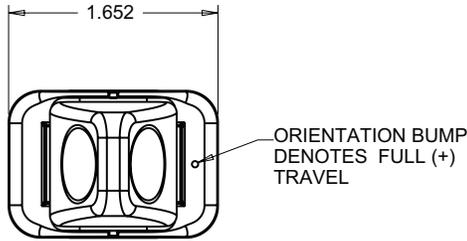
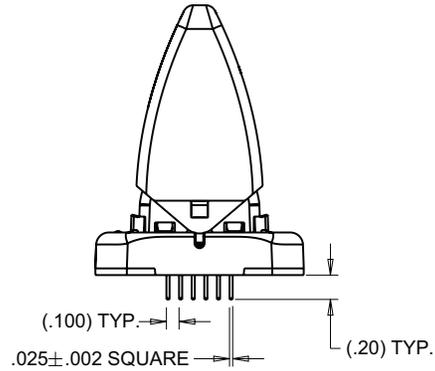

RECOMMENDED PANEL THICKNESS: 0.130 OPTIMUM THICKNESS
(0.125 MIN. - 0.135 MAX.)

RECOMMENDED PANEL OPENING: \varnothing 0.800 OPTIMUM
(0.750 MIN. - 0.850 MAX)

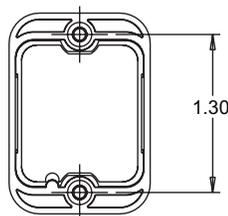
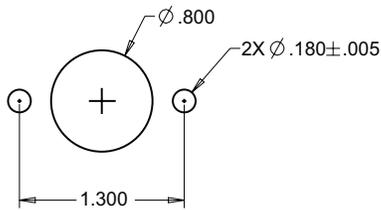

PINNED TERMINATION
NOT ALL PINS ARE PRESENT
IN ALL OUTPUT CONFIGURATIONS

HALL EFFECT

ONE MILLION CYCLE ROTATIONAL LIFE

OPTION A

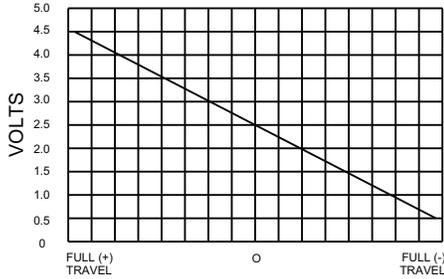

OUTPUT 1 ———
OUTPUT 2 - - -

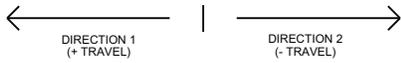

OPTION B



OUTPUT 1 ———
OUTPUT 2 - - -

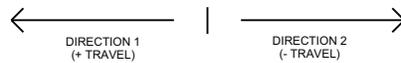

OPTION C

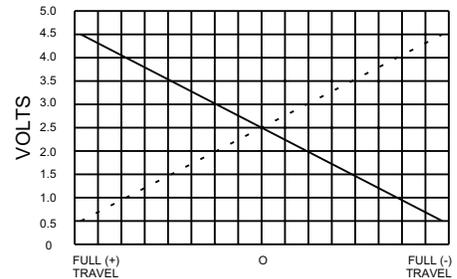

OUTPUT 1 ———
OUTPUT 2 - - -

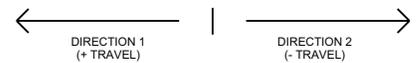

OPTION D

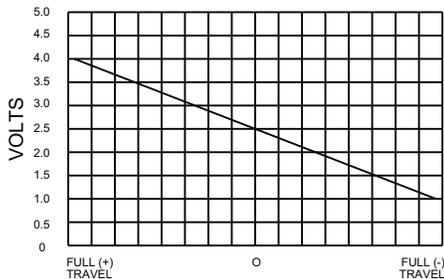

OUTPUT 1 ———
OUTPUT 2 - - -

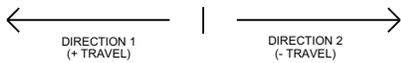

OPTION E

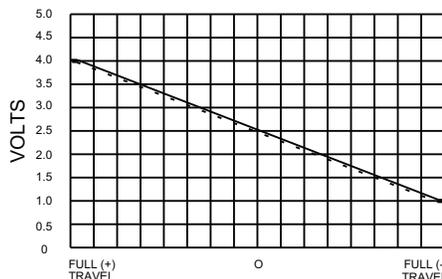

OUTPUT 1 ———
OUTPUT 2 - - -

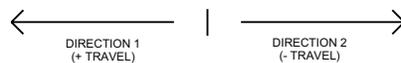

OPTION F

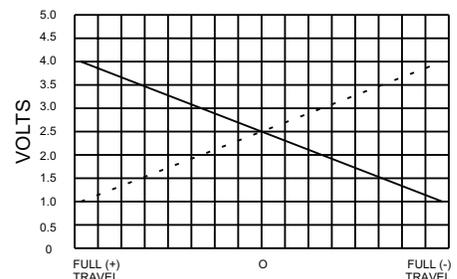

OUTPUT 1 ———
OUTPUT 2 - - -

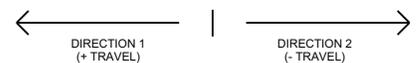

OPTION G

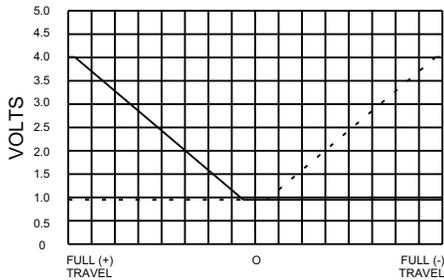

OUTPUT 1 ———
OUTPUT 2 - - -

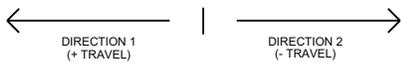

OPTION H

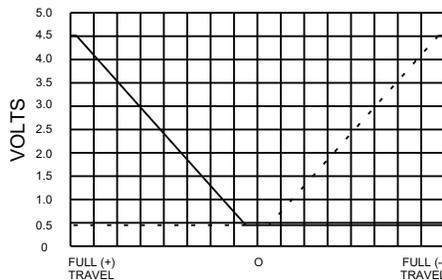

OUTPUT 1 ———
OUTPUT 2 - - -

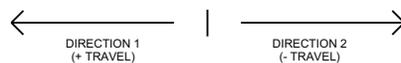

Компания «Life Electronics» занимается поставками электронных компонентов импортного и отечественного производства от производителей и со складов крупных дистрибьюторов Европы, Америки и Азии.

С конца 2013 года компания активно расширяет линейку поставок компонентов по направлению коаксиальный кабель, кварцевые генераторы и конденсаторы (керамические, пленочные, электролитические), за счёт заключения дистрибьюторских договоров

Мы предлагаем:

- Конкурентоспособные цены и скидки постоянным клиентам.
- Специальные условия для постоянных клиентов.
- Подбор аналогов.
- Поставку компонентов в любых объемах, удовлетворяющих вашим потребностям.
- Приемлемые сроки поставки, возможна ускоренная поставка.
- Доставку товара в любую точку России и стран СНГ.
- Комплексную поставку.
- Работу по проектам и поставку образцов.
- Формирование склада под заказчика.
- Сертификаты соответствия на поставляемую продукцию (по желанию клиента).
- Тестирование поставляемой продукции.
- Поставку компонентов, требующих военную и космическую приемку.
- Входной контроль качества.
- Наличие сертификата ISO.

В составе нашей компании организован Конструкторский отдел, призванный помогать разработчикам, и инженерам.

Конструкторский отдел помогает осуществить:

- Регистрацию проекта у производителя компонентов.
- Техническую поддержку проекта.
- Защиту от снятия компонента с производства.
- Оценку стоимости проекта по компонентам.
- Изготовление тестовой платы монтаж и пусконаладочные работы.



Тел: +7 (812) 336 43 04 (многоканальный)

Email: org@lifeelectronics.ru