

# Optocoupler, Phototransistor Output, High Temperature



17918-23



## FEATURES

- Temperature range - 55 °C to + 110 °C
- Rated impulse voltage (transient overvoltage)  
 $V_{IOTM} = 6 \text{ kV}_{peak}$
- Isolation test voltage (partial discharge test voltage)  
 $V_{pd} = 1.6 \text{ kV}$
- Rated isolation voltage (RMS includes DC)  
 $V_{IOWM} = 600 \text{ V}_{RMS}$
- Rated recurring peak voltage (repetitive)  $V_{IORM} = 850 \text{ V}_{peak}$
- Material categorization: For definitions of compliance please see [www.vishay.com/doc?99912](http://www.vishay.com/doc?99912)



**RoHS**  
COMPLIANT

## DESCRIPTION

The VO615A consists of a phototransistor optically coupled to a gallium arsenide infrared-emitting diode in a 4 pin plastic dual inline package.

## AGENCY APPROVALS

(All parts are certified under base model VO615A)

- BSI: EN 60065:2002, EN 60950-1:2006
- DIN EN 60747-5-5 (VDE 0884), available with option 1
- FIMKO: FI25155
- UL 1577 file no. E52744
- cUL 1577 tested to CSA 22.2 bulletin 5A
- CQC file no. 09001038077; 09001038080

## APPLICATIONS

Circuits for safe protective separation against electrical shock according to safety class II (reinforced isolation):

- Application class I to IV at mains voltage  $\leq 300 \text{ V}$
- Application class I to IV at mains voltage  $\leq 600 \text{ V}$  according to table 1 of IEC 60664-1, suitable for:
  - Switch-mode power supplies
  - Line receiver
  - Computer peripheral interface
  - Microprocessor system interface

ORDERING INFORMATION															
<div style="display: flex; justify-content: space-around; align-items: center;"> <div style="border: 1px solid black; padding: 2px;">V</div> <div style="border: 1px solid black; padding: 2px;">O</div> <div style="border: 1px solid black; padding: 2px;">6</div> <div style="border: 1px solid black; padding: 2px;">1</div> <div style="border: 1px solid black; padding: 2px;">5</div> <div style="border: 1px solid black; padding: 2px;">A</div> <div style="border: 1px solid black; padding: 2px;">-</div> <div style="border: 1px solid black; padding: 2px;">#</div> <div style="border: 1px solid black; padding: 2px;">X</div> <div style="border: 1px solid black; padding: 2px;">0</div> <div style="border: 1px solid black; padding: 2px;">#</div> <div style="border: 1px solid black; padding: 2px;">#</div> <div style="border: 1px solid black; padding: 2px;">T</div> </div>															
PART NUMBER						CTR BIN		PACKAGE OPTION			TAPE AND REEL				
AGENCY CERTIFIED/ PACKAGE	CTR (%)														
	5 mA	10 mA				5 mA									
BSI, FIMKO, UL, cUL, CQC (option 1)	50 to 600	40 to 80	63 to 125	100 to 200	160 to 320	50 to 150	100 to 300	80 to 160	130 to 260	200 to 400					
DIP-4	VO615A	VO615A-1	VO615A-2	VO615A-3	VO615A-4	VO615A-5	VO615A-6	VO615A-7	VO615A-8	VO615A-9					
DIP-4, 400 mil, option 6	VO615A-X006	VO615A-1X006	VO615A-2X006	VO615A-3X006	VO615A-4X006	VO615A-5X006	VO615A-6X006	VO615A-7X006	VO615A-8X006	VO615A-9X006					
SMD-4, option 7	VO615A-X007T	VO615A-1X007T	VO615A-2X007T	VO615A-3X007T	VO615A-4X007T	VO615A-5X007T	VO615A-6X007T	VO615A-7X007T	VO615A-8X007T	VO615A-9X007T					
SMD-4, option 8	-	-	-	VO615A-3X008T	-	-	-	-	-	-					
SMD-4, option 9	VO615A-X009T	VO615A-1X009T	VO615A-2X009T	VO615A-3X009T	VO615A-4X009T	VO615A-5X009T	VO615A-6X009T	VO615A-7X009T	-	-					
VDE, BSI, FIMKO, UL, cUL, CQC	50 to 600	40 to 80	63 to 125	100 to 200	160 to 320	50 to 150	100 to 300	80 to 160	130 to 260	200 to 400					
DIP-4	VO615A-X001	VO615A-1X001	VO615A-2X001	VO615A-3X001	VO615A-4X001	-	VO615A-6X001	VO615A-7X001	VO615A-8X001	-					
DIP-4, 400 mil, option 6	-	-	VO615A-2X016	VO615A-3X016	VO615A-4X016	VO615A-5X016	-	-	VO615A-8X016	VO615A-9X016					
SMD-4, option 7	VO615A-X017T	VO615A-1X017T	-	VO615A-3X017T	VO615A-4X017T	-	VO615A-6X017T	VO615A-7X017T	VO615A-8X017T	VO615A-9X017T					
SMD-4, option 8	-	-	-	VO615A-3X018T	VO615A-4X018T	-	-	-	VO615A-8X018T	-					
SMD-4, option 9	-	VO615A-1X019T	VO615A-2X019T	VO615A-3X019T	VO615A-4X019T	-	-	-	-	-					

### Note

- Additional options may be possible, please contact sales office.

<b>ABSOLUTE MAXIMUM RATINGS</b> ( $T_{amb} = 25\text{ }^{\circ}\text{C}$ , unless otherwise specified)				
PARAMETER	TEST CONDITION	SYMBOL	VALUE	UNIT
<b>INPUT</b>				
Reverse voltage		$V_R$	6	V
Forward current		$I_F$	60	mA
Forward surge current	$t_p \leq 10\text{ }\mu\text{s}$	$I_{FSM}$	1.5	A
LED power dissipation	at $25\text{ }^{\circ}\text{C}$	$P_{diss}$	70	mW
<b>OUTPUT</b>				
Collector emitter voltage		$V_{CEO}$	70	V
Emitter collector voltage		$V_{ECO}$	7	V
Collector current		$I_C$	50	mA
Collector peak current	$t_p/T = 0.5, t_p \leq 10\text{ ms}$	$I_{CM}$	100	mA
Output power dissipation	at $25\text{ }^{\circ}\text{C}$	$P_{diss}$	70	mW
<b>COUPLER</b>				
Isolation test voltage (RMS)	$t = 1\text{ s}$	$V_{ISO}$	5000	$V_{RMS}$
Operating ambient temperature range		$T_{amb}$	- 55 to + 110	$^{\circ}\text{C}$
Storage temperature range		$T_{stg}$	- 55 to + 125	$^{\circ}\text{C}$
Soldering temperature <sup>(1)</sup>	2 mm from case, $\leq 10\text{ s}$	$T_{sld}$	260	$^{\circ}\text{C}$

**Notes**

- Stresses in excess of the absolute maximum ratings can cause permanent damage to the device. Functional operation of the device is not implied at these or any other conditions in excess of those given in the operational sections of this document. Exposure to absolute maximum ratings for extended periods of the time can adversely affect reliability.
- <sup>(1)</sup> Refer to reflow profile for soldering conditions for surface mounted devices (SMD), and wave profile for soldering conditions for through hole devices (DIP), please go to "Assembly Instructions" ([www.vishay.com/doc?80054](http://www.vishay.com/doc?80054)).

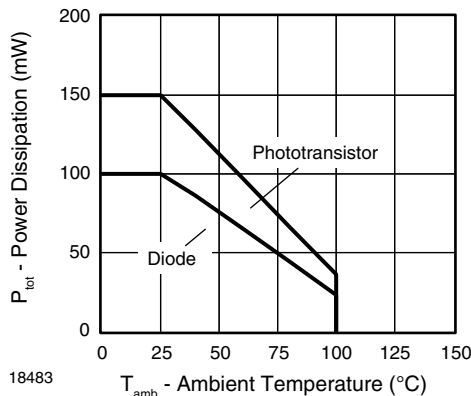

Fig. 1 - Permissible Power Dissipation vs. Ambient Temperature

<b>ELECTRICAL CHARACTERISTICS</b> ( $T_{amb} = 25\text{ }^{\circ}\text{C}$ , unless otherwise specified)						
PARAMETER	TEST CONDITION	SYMBOL	MIN.	TYP.	MAX.	UNIT
<b>INPUT</b>						
Forward voltage	$I_F = 50\text{ mA}$	$V_F$		1.43	1.6	V
Reverse current	$V_R = 6\text{ V}$	$I_R$			100	$\mu\text{A}$
Junction capacitance	$V_R = 0, f = 1\text{ MHz}$	$C_j$		50		pF
<b>OUTPUT</b>						
Collector emitter voltage	$I_C = 1\text{ mA}$	$V_{CEO}$	70			V
Emitter collector voltage	$I_E = 100\text{ }\mu\text{A}$	$V_{ECO}$	7			V
Collector emitter cut-off current	$V_{CE} = 20\text{ V}, I_F = 0$	$I_{CEO}$		10	100	nA
<b>COUPLER</b>						
Collector emitter saturation voltage	$I_F = 10\text{ mA}, I_C = 1\text{ mA}$	$V_{CEsat}$			0.3	V
Cut-off frequency	$V_{CE} = 5\text{ V}, I_F = 10\text{ mA}, R_L = 100\text{ }\Omega$	$f_c$		110		kHz
Coupling capacitance	$f = 1\text{ MHz}$	$C_k$		0.6		pF

**Note**

- Minimum and maximum values are testing requirements. Typical values are characteristics of the device and are the result of engineering evaluation. Typical values are for information only and are not part of the testing requirements.

<b>CURRENT TRANSFER RATIO</b> ( $T_{amb} = 25\text{ }^{\circ}\text{C}$ , unless otherwise specified)							
PARAMETER	TEST CONDITION	PART	SYMBOL	MIN.	TYP.	MAX.	UNIT
$I_C/I_F$	$V_{CE} = 5\text{ V}$ , $I_F = 1\text{ mA}$	VO615A-1	CTR	13	30		%
		VO615A-2	CTR	22	45		%
		VO615A-3	CTR	34	70		%
		VO615A-4	CTR	56	90		%
	$V_{CE} = 5\text{ V}$ , $I_F = 5\text{ mA}$	VO615A	CTR	50		600	%
		VO615A-5	CTR	50		150	%
		VO615A-6	CTR	100		300	%
		VO615A-7	CTR	80		160	%
		VO615A-8	CTR	130		260	%
	$V_{CE} = 5\text{ V}$ , $I_F = 10\text{ mA}$	VO615A-9	CTR	200		400	%
		VO615A-1	CTR	40		80	%
		VO615A-2	CTR	63		125	%
		VO615A-3	CTR	100		200	%
VO615A-4	CTR	160		320	%		

<b>SAFETY AND INSULATION RATED PARAMETERS</b>						
PARAMETER	TEST CONDITION	SYMBOL	MIN.	TYP.	MAX.	UNIT
Partial discharge test voltage - routine test	100 %, $t_{test} = 1\text{ s}$	$V_{pd}$	1.6			kV
Partial discharge test voltage - lot test (sample test)	$t_{Tr} = 60\text{ s}$ , $t_{test} = 10\text{ s}$ , (see figure 2)	$V_{pd}$	1.36			kV
Insulation resistance	$V_{IO} = 500\text{ V}$	$R_{IO}$	$10^{12}$			$\Omega$
	$V_{IO} = 500\text{ V}$ , $T_{amb} = 100\text{ }^{\circ}\text{C}$	$R_{IO}$	$10^{11}$			$\Omega$
	$V_{IO} = 500\text{ V}$ , $T_{amb} = 150\text{ }^{\circ}\text{C}$ (construction test only)	$R_{IO}$	$10^9$			$\Omega$
Rated impulse voltage		$V_{IOTM}$			6000	$V_{peak}$
Max. working voltages	Recurring peak voltage	$V_{IORM}$			850	$V_{peak}$
Forward current		$I_{SI}$			130	mA
Power dissipation		$P_{SO}$			265	mW
Safety temperature		$T_{si}$			150	$^{\circ}\text{C}$
Creepage distance					7.6	mm

**Note**

- According to DIN EN 60747-5-5 (VDE 0884), § 7.4.3.8.2 (see figure 2). This optocoupler is suitable for safe electrical isolation only within the safety ratings. Compliance with the safety ratings shall be ensured by means of suitable protective circuits.



Fig. 2 - Derating Diagram



Fig. 3 - Test Pulse Diagram for Sample Test According to DIN EN 60747-5-2 (VDE 0884); IEC 60747-5-5

SWITCHING CHARACTERISTICS ( $T_{amb} = 25\text{ }^{\circ}\text{C}$ , unless otherwise specified)						
PARAMETER	TEST CONDITION	SYMBOL	MIN.	TYP.	MAX.	UNIT
Delay time	$V_S = 5\text{ V}$ , $I_C = 2\text{ mA}$ , $R_L = 100\ \Omega$	$t_d$		3		$\mu\text{s}$
Rise time	$V_S = 5\text{ V}$ , $I_C = 2\text{ mA}$ , $R_L = 100\ \Omega$	$t_r$		3		$\mu\text{s}$
Fall time	$V_S = 5\text{ V}$ , $I_C = 2\text{ mA}$ , $R_L = 100\ \Omega$	$t_f$		4.7		$\mu\text{s}$
Storage time	$V_S = 5\text{ V}$ , $I_C = 2\text{ mA}$ , $R_L = 100\ \Omega$	$t_s$		0.3		$\mu\text{s}$
Turn-on time	$V_S = 5\text{ V}$ , $I_C = 2\text{ mA}$ , $R_L = 100\ \Omega$	$t_{on}$		6		$\mu\text{s}$
Turn-off time	$V_S = 5\text{ V}$ , $I_C = 2\text{ mA}$ , $R_L = 100\ \Omega$	$t_{off}$		5		$\mu\text{s}$
Turn-on time	$V_S = 5\text{ V}$ , $I_F = 10\text{ mA}$ , $R_L = 1\text{ k}\Omega$	$t_{on}$		3		$\mu\text{s}$
Turn-off time	$V_S = 5\text{ V}$ , $I_F = 10\text{ mA}$ , $R_L = 1\text{ k}\Omega$	$t_{off}$		10		$\mu\text{s}$



Fig. 4 - Test Circuit



Fig. 5 - Test Circuit and Waveforms

**TYPICAL CHARACTERISTICS** ( $T_{amb} = 25\text{ }^{\circ}\text{C}$ , unless otherwise specified)



Fig. 6 - Forward Voltage vs. Forward Current



Fig. 8 - Leakage Current vs. Ambient Temperature



Fig. 7 - Collector Current vs. Collector Emitter Voltage (NS)



Fig. 9 - Collector Current vs. Collector Emitter Voltage (sat)



Fig. 10 - Normalized CTR (sat) vs. Ambient Temperature



Fig. 13 - Normalized CTR (sat) vs. Forward Current



Fig. 11 - Normalized CTR (NS) vs. Ambient Temperature



Fig. 14 -  $F_{CTR}$  vs.  $I_C$  (sat) (mA)



Fig. 12 - Normalized CTR (NS) vs. Forward Current

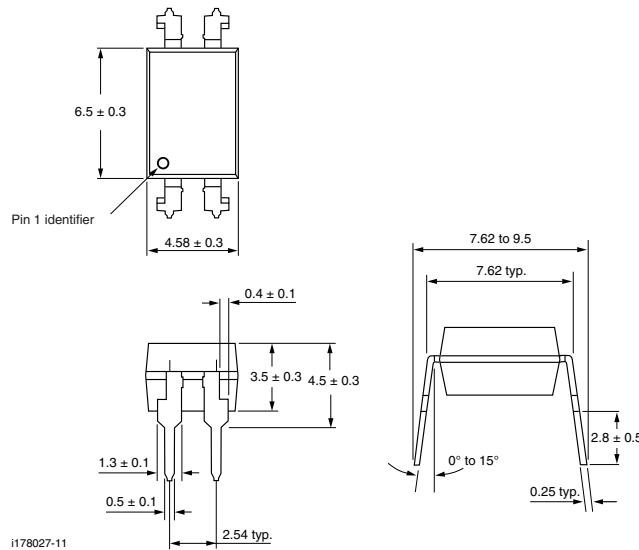

Fig. 15 -  $F_{CTR}$  vs. Phase Angle (kHz)

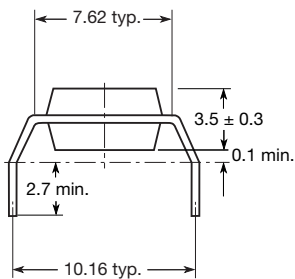

Fig. 16 - Switching Time vs. Load Resistance

**PACKAGE DIMENSIONS** in millimeters



**Option 6**



**Option 7**

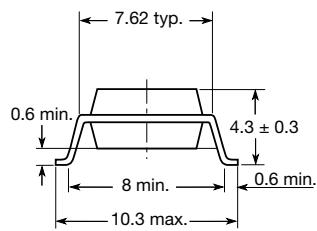

**Option 8**

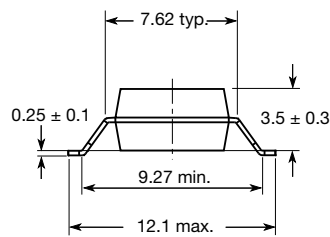

**Option 9**

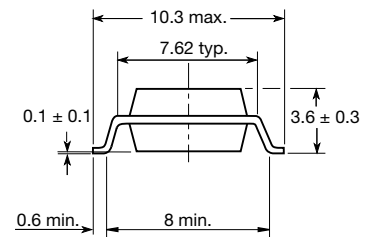

20802-36

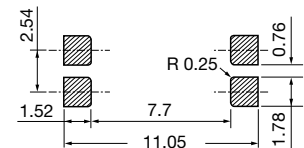
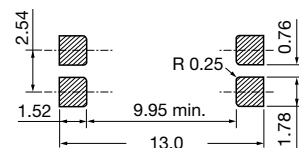
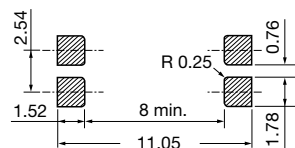

**PACKAGE MARKING** (Example of VO615A-3X017T)



**Notes**

- Only options 1, 7, and 8 are reflected in the package marking.
- The VDE logo is only marked on option 1 parts.
- Tape and reel suffix (T) is not part of the package marking.

**PACKING INFORMATION**

DEVICE PER TUBE			
TYPE	UNITS/TUBE	TUBES/BOX	UNITS/BOX
DIP-4, standard and option 6	100	40	4000

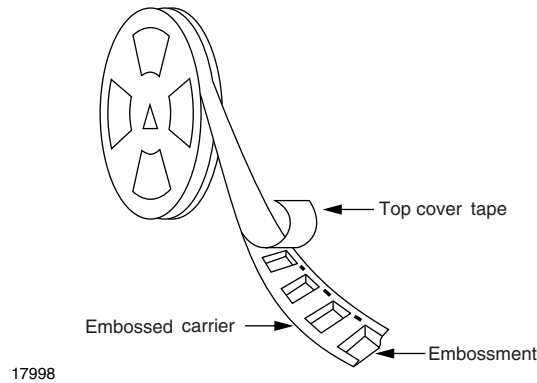

17998

Fig. 17 - Tape and Reel Shipping Medium

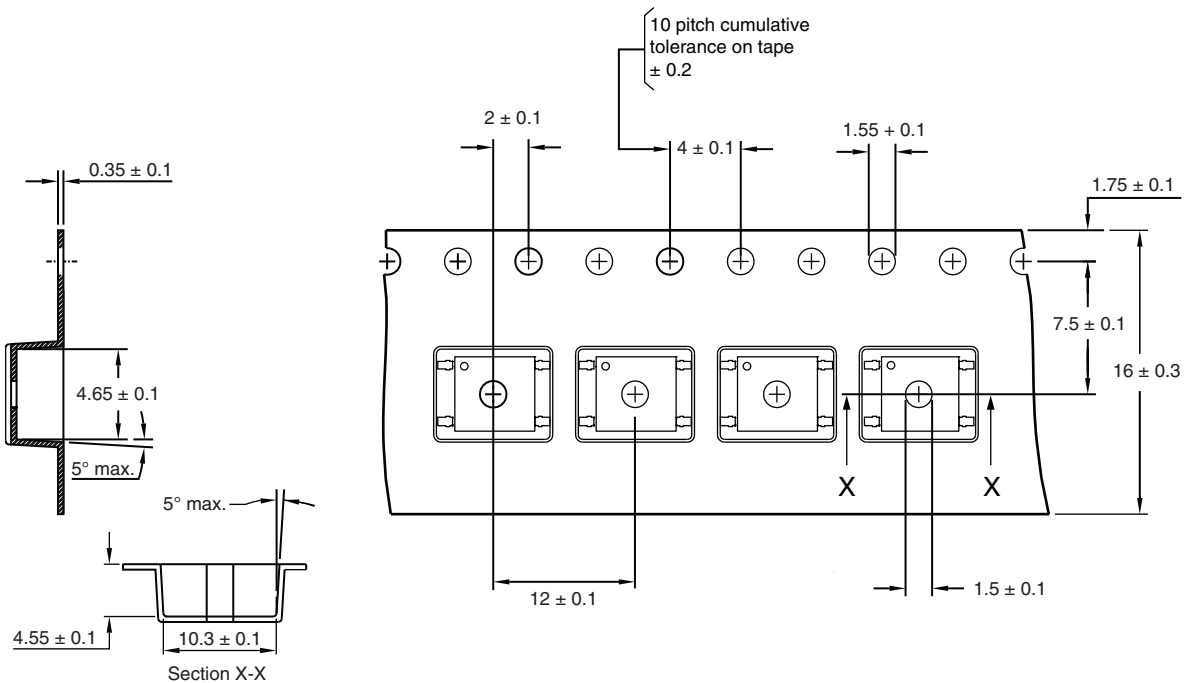

Fig. 18 - Tape and Reel Packing for Option 7 and Option 9 (1000 units per reel)



Fig. 19 - Tape and Reel Packing for Option 8  
(2000 units per reel)





## Disclaimer

ALL PRODUCT, PRODUCT SPECIFICATIONS AND DATA ARE SUBJECT TO CHANGE WITHOUT NOTICE TO IMPROVE RELIABILITY, FUNCTION OR DESIGN OR OTHERWISE.

Vishay Intertechnology, Inc., its affiliates, agents, and employees, and all persons acting on its or their behalf (collectively, "Vishay"), disclaim any and all liability for any errors, inaccuracies or incompleteness contained in any datasheet or in any other disclosure relating to any product.

Vishay makes no warranty, representation or guarantee regarding the suitability of the products for any particular purpose or the continuing production of any product. To the maximum extent permitted by applicable law, Vishay disclaims (i) any and all liability arising out of the application or use of any product, (ii) any and all liability, including without limitation special, consequential or incidental damages, and (iii) any and all implied warranties, including warranties of fitness for particular purpose, non-infringement and merchantability.

Statements regarding the suitability of products for certain types of applications are based on Vishay's knowledge of typical requirements that are often placed on Vishay products in generic applications. Such statements are not binding statements about the suitability of products for a particular application. It is the customer's responsibility to validate that a particular product with the properties described in the product specification is suitable for use in a particular application. Parameters provided in datasheets and/or specifications may vary in different applications and performance may vary over time. All operating parameters, including typical parameters, must be validated for each customer application by the customer's technical experts. Product specifications do not expand or otherwise modify Vishay's terms and conditions of purchase, including but not limited to the warranty expressed therein.

Except as expressly indicated in writing, Vishay products are not designed for use in medical, life-saving, or life-sustaining applications or for any other application in which the failure of the Vishay product could result in personal injury or death. Customers using or selling Vishay products not expressly indicated for use in such applications do so at their own risk. Please contact authorized Vishay personnel to obtain written terms and conditions regarding products designed for such applications.

No license, express or implied, by estoppel or otherwise, to any intellectual property rights is granted by this document or by any conduct of Vishay. Product names and markings noted herein may be trademarks of their respective owners.

## Material Category Policy

**Vishay Intertechnology, Inc. hereby certifies that all its products that are identified as RoHS-Compliant fulfill the definitions and restrictions defined under Directive 2011/65/EU of The European Parliament and of the Council of June 8, 2011 on the restriction of the use of certain hazardous substances in electrical and electronic equipment (EEE) - recast, unless otherwise specified as non-compliant.**

**Please note that some Vishay documentation may still make reference to RoHS Directive 2002/95/EC. We confirm that all the products identified as being compliant to Directive 2002/95/EC conform to Directive 2011/65/EU.**

**Vishay Intertechnology, Inc. hereby certifies that all its products that are identified as Halogen-Free follow Halogen-Free requirements as per JEDEC JS709A standards. Please note that some Vishay documentation may still make reference to the IEC 61249-2-21 definition. We confirm that all the products identified as being compliant to IEC 61249-2-21 conform to JEDEC JS709A standards.**

Компания «Life Electronics» занимается поставками электронных компонентов импортного и отечественного производства от производителей и со складов крупных дистрибьюторов Европы, Америки и Азии.

С конца 2013 года компания активно расширяет линейку поставок компонентов по направлению коаксиальный кабель, кварцевые генераторы и конденсаторы (керамические, пленочные, электролитические), за счёт заключения дистрибьюторских договоров

Мы предлагаем:

- Конкурентоспособные цены и скидки постоянным клиентам.
- Специальные условия для постоянных клиентов.
- Подбор аналогов.
- Поставку компонентов в любых объемах, удовлетворяющих вашим потребностям.
- Приемлемые сроки поставки, возможна ускоренная поставка.
- Доставку товара в любую точку России и стран СНГ.
- Комплексную поставку.
- Работу по проектам и поставку образцов.
- Формирование склада под заказчика.
- Сертификаты соответствия на поставляемую продукцию (по желанию клиента).
- Тестирование поставляемой продукции.
- Поставку компонентов, требующих военную и космическую приемку.
- Входной контроль качества.
- Наличие сертификата ISO.

В составе нашей компании организован Конструкторский отдел, призванный помогать разработчикам, и инженерам.

Конструкторский отдел помогает осуществить:

- Регистрацию проекта у производителя компонентов.
- Техническую поддержку проекта.
- Защиту от снятия компонента с производства.
- Оценку стоимости проекта по компонентам.
- Изготовление тестовой платы монтаж и пусконаладочные работы.



Тел: +7 (812) 336 43 04 (многоканальный)

Email: [org@lifeelectronics.ru](mailto:org@lifeelectronics.ru)