



SILEGO

SLG59H1016V

A 22 V, 13.1 mΩ, 3.5 A, 125°C-Rated, Integrated Power Switch with VIN Lockout Select and MOSFET Current Monitor Output

General Description

The SLG59H1016V is a high-performance, self-powered 13.1 mΩ NMOS power switch designed for all 4.5 to 22 V power rails up to 3.5 A. Using a proprietary MOSFET design, the SLG59H1016V achieves a stable 13.1 mΩ RDSON across a wide input/supply voltage range. Using Silego's proprietary CuFET™ technology, the SLG59H1016V package also exhibits a low thermal resistance for high-current operation.

Designed to operate over a -40°C to 125°C range, the SLG59H1016V is available in a low thermal resistance, RoHS-compliant, 1.6 x 3.0 mm STQFN package.

Features

- Wide Operating Supply Voltage: 4.5 V to 22 V
- Maximum Continuous Switch Current: 3.5 A
- Automatic nFET SOA Protection
- High-performance MOSFET Switch
 - Low RDSON: 13.1 mΩ at $V_{IN} = 22\text{ V}$
 - Low $\Delta RDSON/\Delta V_{IN}$: $<0.05\text{ m}\Omega/\text{V}$
 - Low $\Delta RDSON/\Delta T$: $<0.06\text{ m}\Omega/^\circ\text{C}$
- 4-Level, Pin-programmable VIN Overvoltage Lockout
- Capacitor-programmable Inrush Current Control
- Two stage Current Limit Protection:
 - Resistor-programmable Active Current Limit
 - Internal Short-circuit Current limit
- Open Drain FAULT Signaling
- MOSFET Current Analog Output Monitor: 10 $\mu\text{A}/\text{A}$
- Fast 4 kΩ Output Discharge
- Pb-Free / Halogen-Free / RoHS Compliant Packaging

Pin Configuration

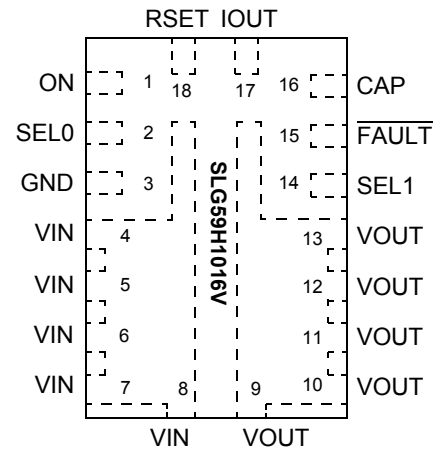

18-pin STQFN
1.6 x 3.0 mm, 0.40mm pitch
(Top View)

Applications

- Power-Rail Switching
- Multifunction Printers
- Large-format Copiers
- Telecommunications Equipment
- High-performance Computing
 - 5V, 9V, 12V, and 20V Point-of-Load Power Distribution
- Motor Drives

Block Diagram and a 20V / 3 A Typical Application Circuit

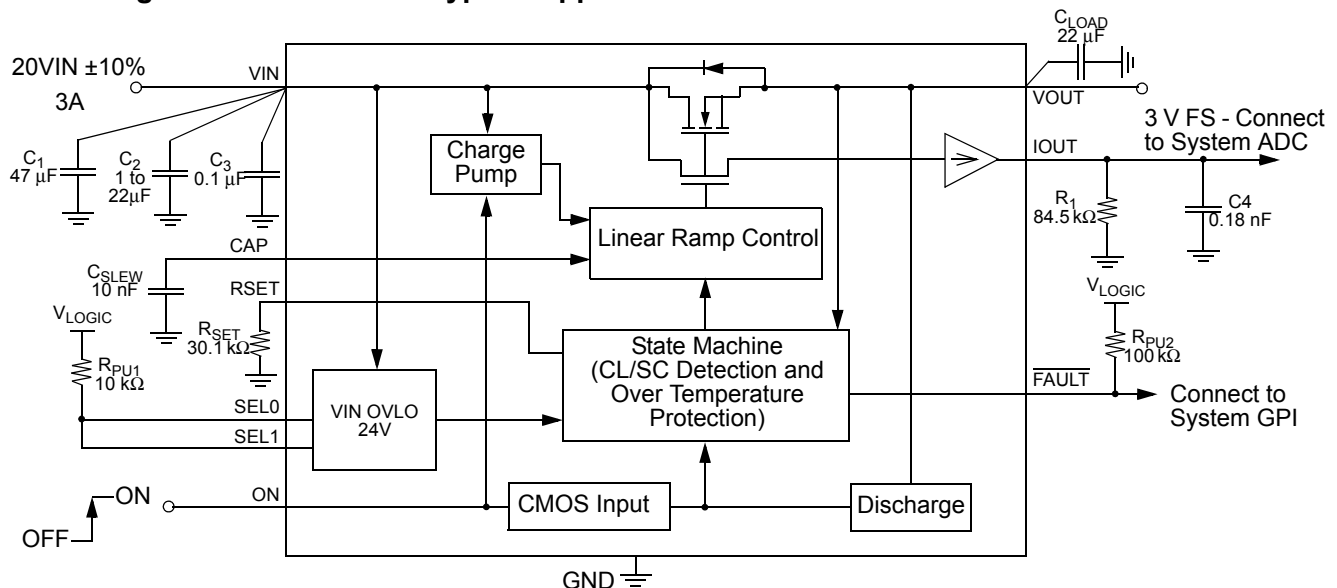



Pin Description

Pin #	Pin Name	Type	Pin Description
1	ON	Input	A low-to-high transition on this pin initiates the operation of the SLG59H1016V's state machine. ON is an asserted HIGH, level-sensitive CMOS input with $V_{IL} < 0.3\text{ V}$ and $V_{IH} > 0.9\text{ V}$. As the ON pin input circuit does not have an internal pull-down resistor, connect this pin to a general-purpose output (GPO) of a microcontroller, an application processor, or a system controller – do not allow this pin to be open-circuited.
2	SEL0	Input	As level-sensitive, CMOS inputs with $V_{IL} < 0.3\text{ V}$ and $V_{IH} > 1.65\text{ V}$, the SEL0 (LSB) and the SEL1 (MSB) pins select one of four V_{IN} overvoltage lockout thresholds. Please see the Applications Section for additional information and the Electrical Characteristics table for the V_{IN} overvoltage thresholds. A logic LOW on either pin is achieved by connecting the pin of interest to GND; a logic HIGH on either pin is achieved by connecting a 10 k Ω external resistor from the pin in question to the system's local logic supply.
3	GND	GND	Pin 3 is the main ground connection for the SLG59H1016V's internal charge pump, its gate drive and current-limit circuits as well as its internal state machine. Therefore, use a short, stout connection from Pin 3 to the system's analog or power plane.
4-8	VIN	MOSFET	VIN supplies the power for the operation of the SLG59H1016V, its internal control circuitry, and the drain terminal of the nFET power switch. With 5 pins fused together at VIN, connect a 47 μF (or larger) low-ESR capacitor from this pin to ground. Capacitors used at VIN should be rated at 50 V or higher.
9-13	VOUT	MOSFET	Source terminal of n-channel MOSFET (5 pins fused for VOUT). Connect a 22 μF (or larger) low-ESR capacitor from this pin to ground. Capacitors used at VOUT should be rated at 50 V or higher.
14	SEL1	Input	Please see SEL0 Pin Description above
15	$\overline{\text{FAULT}}$	Output	An open drain output, FAULT is asserted within $T_{\text{FAULT_LOW}}$ when a $V_{IN_overvoltage}$, a current-limit, a nFET SOA, or an over-temperature condition is detected. FAULT is deasserted within $T_{\text{FAULT_HIGH}}$ when the fault condition is removed. Connect an 100 k Ω external resistor from the FAULT pin to local system logic supply.
16	CAP	Output	A low-ESR, stable dielectric, ceramic surface-mount capacitor connected from CAP pin to GND sets the V_{OUT} slew rate and overall turn-on time of the SLG59H1016V. For best performance, the range for C_{SLEW} values are $10\text{ nF} \leq C_{\text{SLEW}} \leq 20\text{ nF}$ – please see typical characteristics for additional information. Capacitors used at the CAP pin should be rated at 10 V or higher. Please consult Applications Section on how to select C_{SLEW} based on V_{OUT} slew rate and loading conditions.
17	IOUT	Output	IOUT is the SLG59H1016V's power MOSFET load current monitor output. As an analog output current, this signal when applied to a ground-reference resistor generates a voltage proportional to the current through the n-channel MOSFET. The I_{OUT} transfer characteristic is typically 10 $\mu\text{A/A}$ with a voltage compliance range of $0.5\text{ V} \leq V_{\text{IOUT}} \leq 4\text{ V}$. Optimal IOUT linearity is exhibited for $0.5\text{ A} \leq I_{\text{DS}} \leq 3.5\text{ A}$. In addition, it is recommended to bypass the IOUT pin to GND with a 0.18 nF capacitor.
18	RSET	Input	A 1%-tolerance, metal-film resistor between 23.5 k Ω and 95 k Ω sets the SLG59H1016V's active current limit. A 95 k Ω resistor sets the SLG59H1016V's active current limit to 1 A and a 23.5 k Ω resistor sets the active current limit to 4 A.

Ordering Information

Part Number	Type	Production Flow
SLG59H1016V	STQFN 18L FC	Extended Industrial, -40 °C to 125 °C
SLG59H1016VTR	STQFN 18L FC (Tape and Reel)	Extended Industrial, -40 °C to 125 °C



Absolute Maximum Ratings

Parameter	Description	Conditions	Min.	Typ.	Max.	Unit
V _{IN} to GND	Power Switch Input Voltage to GND	Continuous	-0.3	--	30	V
		Maximum pulsed V _{IN} , pulse width <0.1s	--	--	32	V
V _{OUT} to GND	Power Switch Output Voltage to GND		-0.3	--	V _{IN}	V
ON, SEL[1,0], CAP, RSET, IOUT, and FAULT to GND	ON, SEL[1,0], CAP, RSET, IOUT, and FAULT Pin Voltages to GND		-0.3	--	7	V
T _S	Storage Temperature		-65	--	150	°C
ESD _{HBM}	ESD Protection	Human Body Model	2000	--	--	V
ESD _{CDM}	ESD Protection	Charged Device Model	500	--	--	V
MSL	Moisture Sensitivity Level		1			
θ _{JA}	Thermal Resistance	1.6 x 3.0 mm 18L STQFN; Determined with the device mounted onto a 1 in ² , 1 oz. copper pad of FR-4 material	--	40	--	°C/W
MOSFET IDS _{CONT}	Continuous Current from V _{IN} to V _{OUT}	T _J < 150°C	--	--	4	A
MOSFET IDS _{PEAK}	Peak Current from V _{IN} to V _{OUT}	Maximum pulsed switch current, pulse width < 1 ms	--	--	5	A

Note: Stresses greater than those listed under "Absolute Maximum Ratings" may cause permanent damage to the device. This is a stress rating only and functional operation of the device at these or any other conditions above those indicated in the operational sections of this specification is not implied. Exposure to absolute maximum rating conditions for extended periods may affect reliability.

Electrical Characteristics

4.5 V ≤ V_{IN} ≤ 22 V; C_{IN} = 47 μF, T_A = -40°C to 125°C, unless otherwise noted. Typical values are at T_A = 25°C

Parameter	Description	Conditions	Min.	Typ.	Max.	Unit
V _{IN}	Operating Input Voltage		4.5	--	22	V
V _{IN(OVLO)}	V _{IN} Overvoltage Lockout Threshold	V _{IN} ↑; SEL[1,0] = [0,0]	5.6	6	6.3	V
		V _{IN} ↑; SEL[1,0] = [0,1]	10.2	10.8	11.4	V
		V _{IN} ↑; SEL[1,0] = [1,0]	13.6	14.4	15.2	V
		V _{IN} ↑; SEL[1,0] = [1,1]	22.7	24	25.2	V
V _{IN(UVLO)}	V _{IN} Undervoltage Lockout Threshold	V _{IN} ↓	1.9	--	3.8	V
I _Q	Quiescent Supply Current	ON = HIGH; I _{DS} = 0 A	--	0.5	0.7	mA
I _{SHDN}	OFF Mode Supply Current	ON = LOW; I _{DS} = 0 A	--	1	12	μA
RDS _{ON}	Static Drain to Source ON Resistance	T _A = 25°C; I _{DS} = 0.1 A	--	13.1	14	mΩ
		T _A = 125°C; I _{DS} = 0.1 A	--	20	22	mΩ
I _{LIMIT}	Active Current Limit, I _{ACL}	V _{OUT} > 0.5 V; R _{SET} = 30.1 kΩ	2.8	3.2	3.6	A
	Short-circuit Current Limit, I _{SCL}	V _{OUT} < 0.5 V	--	0.5	--	A
T _{ACL}	Active Current Limit Response Time		--	120	--	μs



Electrical Characteristics (continued)

4.5 V ≤ V_{IN} ≤ 22 V; C_{IN} = 47 μF, T_A = -40°C to 125°C, unless otherwise noted. Typical values are at T_A = 25°C

Parameter	Description	Conditions	Min.	Typ.	Max.	Unit
R _{DSCHRG}	Output Discharge Resistance		3.5	4.4	5.3	kΩ
I _{OUT}	MOSFET Current Analog Monitor Output	I _{LOAD} = 1 A	8.8	9.9	11	μA
		I _{LOAD} = 3 A	27	30	33	μA
T _{IOUT}	I _{OUT} Response Time to Change in Main MOSFET Current	C _{IOUT} = 180 pF; Step load 0 to 2.4 A; 0% to 90% I _{OUT}	--	45	--	μs
C _{LOAD}	Output Load Capacitance	C _{LOAD} connected from V _{OUT} to GND	--	22	--	μF
T _{ON_Delay}	ON Delay Time	50% ON to 10% V _{OUT} ↑; V _{IN} = 4.5 V; C _{SLEW} = 10 nF; R _{LOAD} = 100 Ω, C _{LOAD} = 10 μF	--	0.4	0.5	ms
		50% ON to 10% V _{OUT} ↑; V _{IN} = 22 V; C _{SLEW} = 10 nF; R _{LOAD} = 100 Ω, C _{LOAD} = 10 μF	--	0.8	1.2	ms
T _{Total_ON}	Total Turn-on Time	50% ON to 90% V _{OUT} ↑	Set by External C _{SLEW} ¹			ms
		50% ON to 90% V _{OUT} ↑; V _{IN} = 4.5 V; C _{SLEW} = 10 nF; R _{LOAD} = 100 Ω, C _{LOAD} = 10 μF	--	1.4	2.1	ms
		50% ON to 90% V _{OUT} ↑; V _{IN} = 22 V; C _{SLEW} = 10 nF; R _{LOAD} = 100 Ω, C _{LOAD} = 10 μF	--	5	8	ms
V _{OUT(SR)}	VOUT Slew rate	10% V _{OUT} to 90% V _{OUT} ↑	Set by External C _{SLEW} ¹			V/ms
		10% V _{OUT} to 90% V _{OUT} ↑; V _{IN} = 4.5 to 22 V; C _{SLEW} = 10 nF; R _{LOAD} = 100 Ω, C _{LOAD} = 10 μF	2.4	3.2	4.0	V/ms
T _{OFF_Delay}	OFF Delay Time	50% ON to V _{OUT} ↓; R _{LOAD} = 100 Ω, No C _{LOAD}	--	18	--	μs
T _{Fall}	VOUT Fall Time	ON = HIGH-to-LOW; R _{LOAD} = 100 Ω, No C _{LOAD}	8	13	20	μs
T _{FAULT_LOW}	FAULT Assertion Time	Abnormal Step Load Current event to Fault ↓; I _{ACL} = 1 A; V _{IN} = 22 V; R _{SET} = 90 kΩ; switch in 20 Ω load;	--	80	--	μs
T _{FAULT_HIGH}	FAULT De-assertion Time	Delay to FAULT ↑ after fault condition is removed; I _{ACL} = 1 A; V _{IN} = 22 V; R _{SET} = 90 kΩ; switch out 20 Ω load	--	180	--	μs
FAULT _{VOL}	FAULT Output Low Voltage	I _{FAULT} = 1 mA	--	0.2	--	V
ON_VIH	ON Pin Input High Voltage		0.9	--	5	V
ON_VIL	ON Pin Input Low Voltage		-0.3	0	0.3	V
SEL[1,0]_VIH	SEL[1,0] pins Input High Voltage		1.65	--	4.5	V
SEL[1,0]_VIL	SEL[1,0] pins Input Low Voltage		-0.3	--	0.3	V
I _{ON(Leakage)}	ON Pin Leakage Current	1V ≤ ON ≤ 5V or ON = GND	--	--	1	μA
THERM _{ON}	Thermal Protection Shutdown Threshold		--	150	--	°C
THERM _{OFF}	Thermal Protection Restart Threshold		--	125	--	°C

Notes:

1. Refer to typical Timing Parameter vs. C_{SLEW} performance charts for additional information when available.



T_{Total_ON} , T_{ON_Delay} and Slew Rate Measurement Timing Details

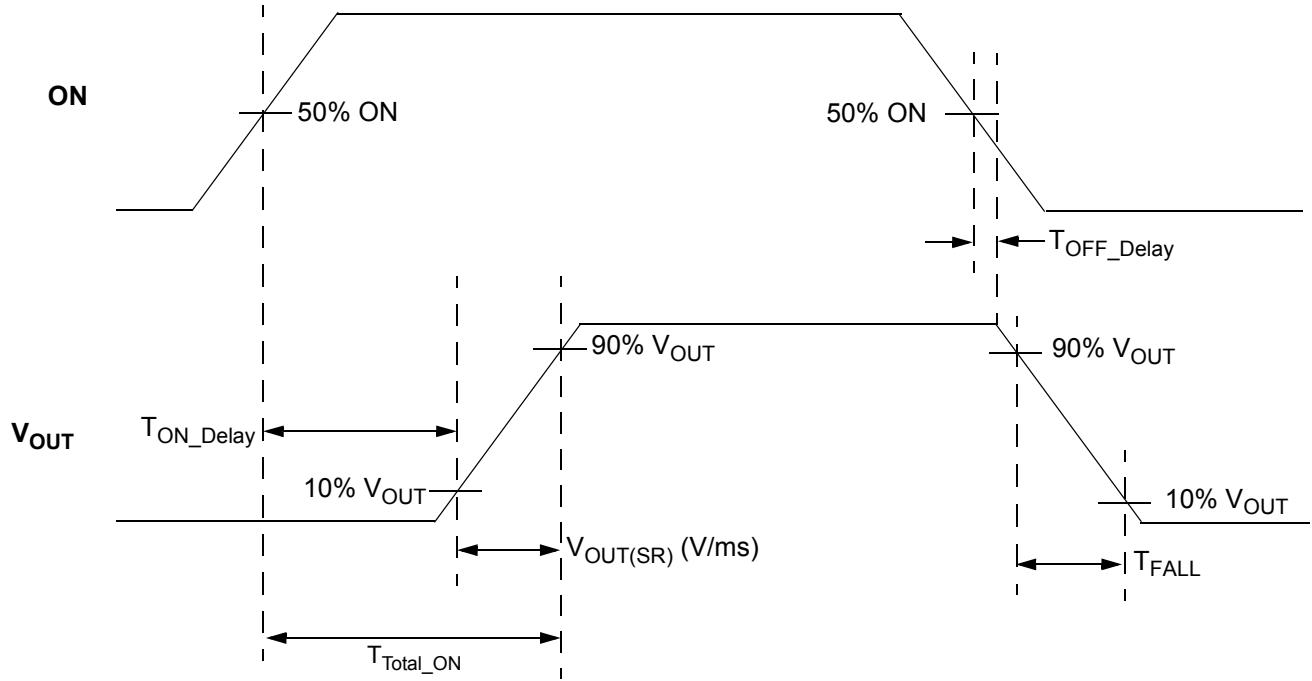



Typical Performance Characteristics

RDS_{ON} vs. Temperature and V_{IN}

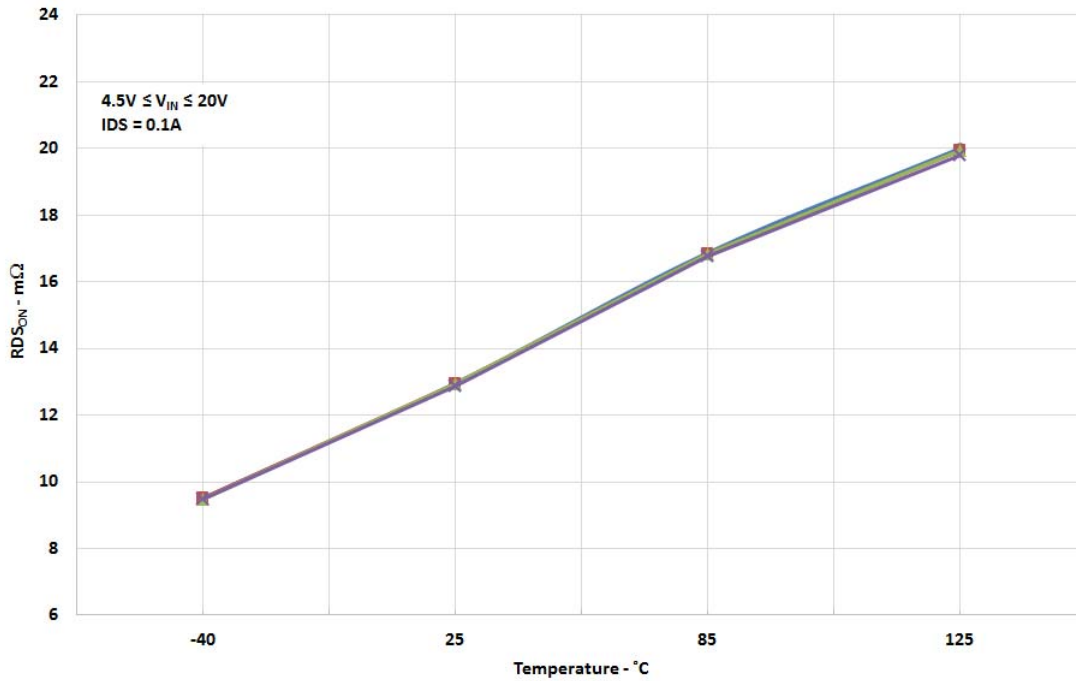

I_{ACL} vs. Temperature, R_{SET}, and V_{IN}

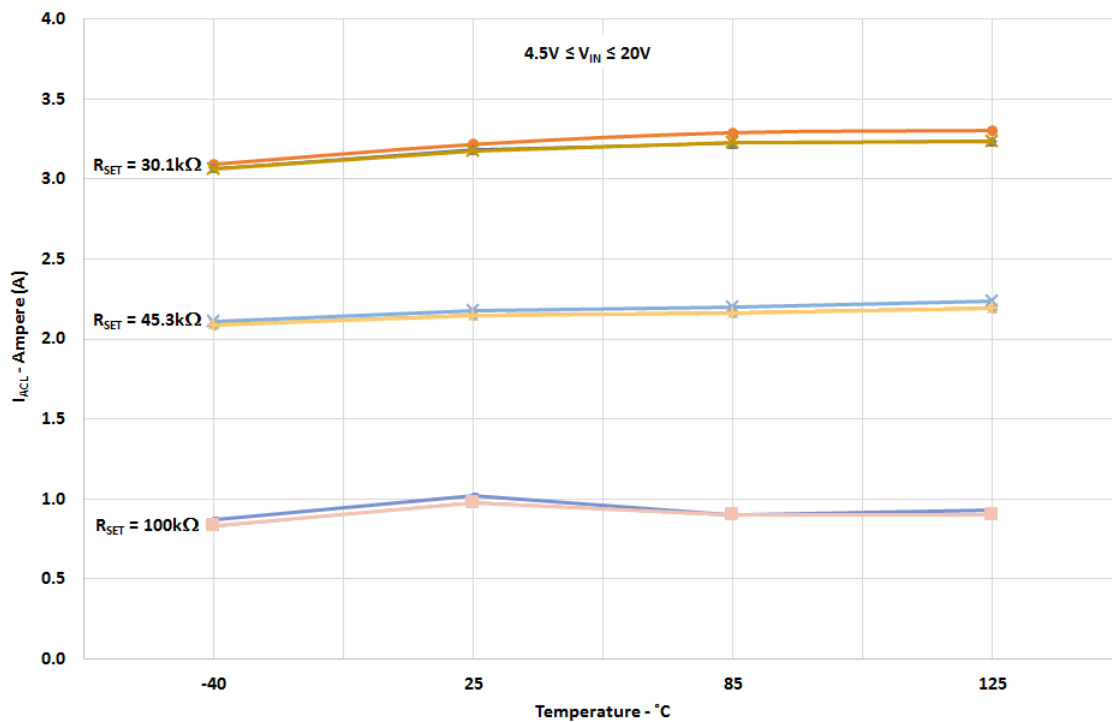



I_{OUT} vs. MOSFET I_{DS} and V_{IN}

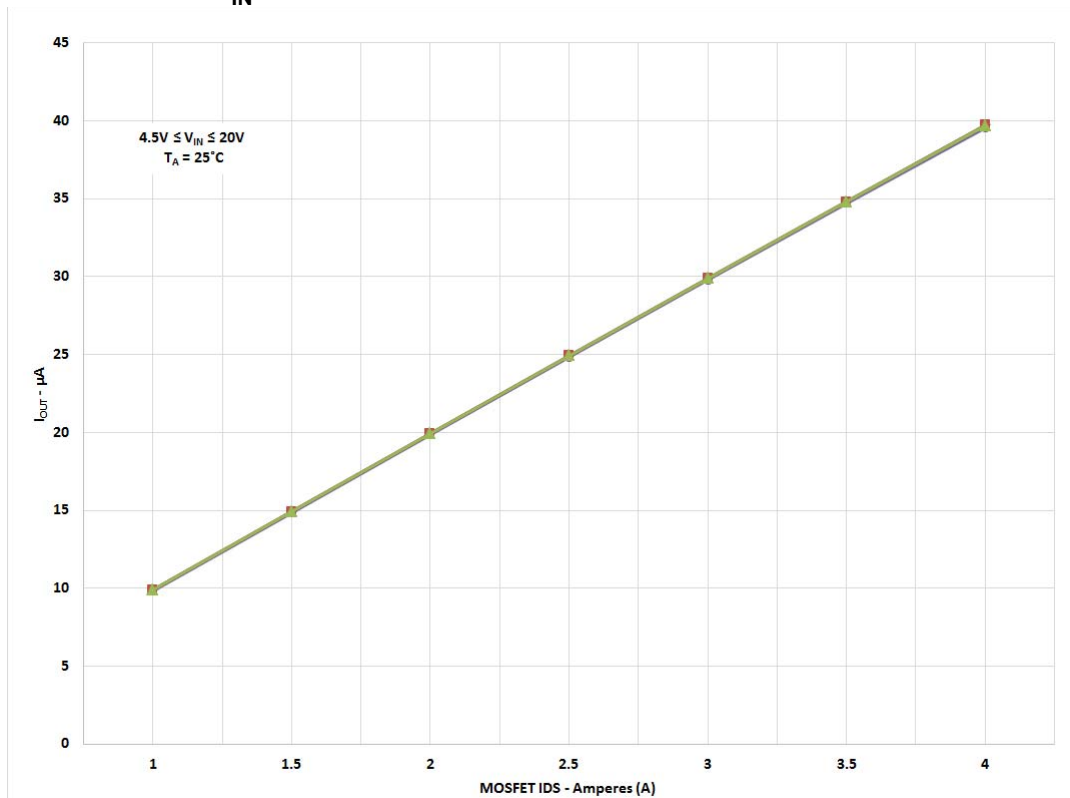

I_{OUT} vs. Temperature, MOSFET I_{DS} , and V_{IN}

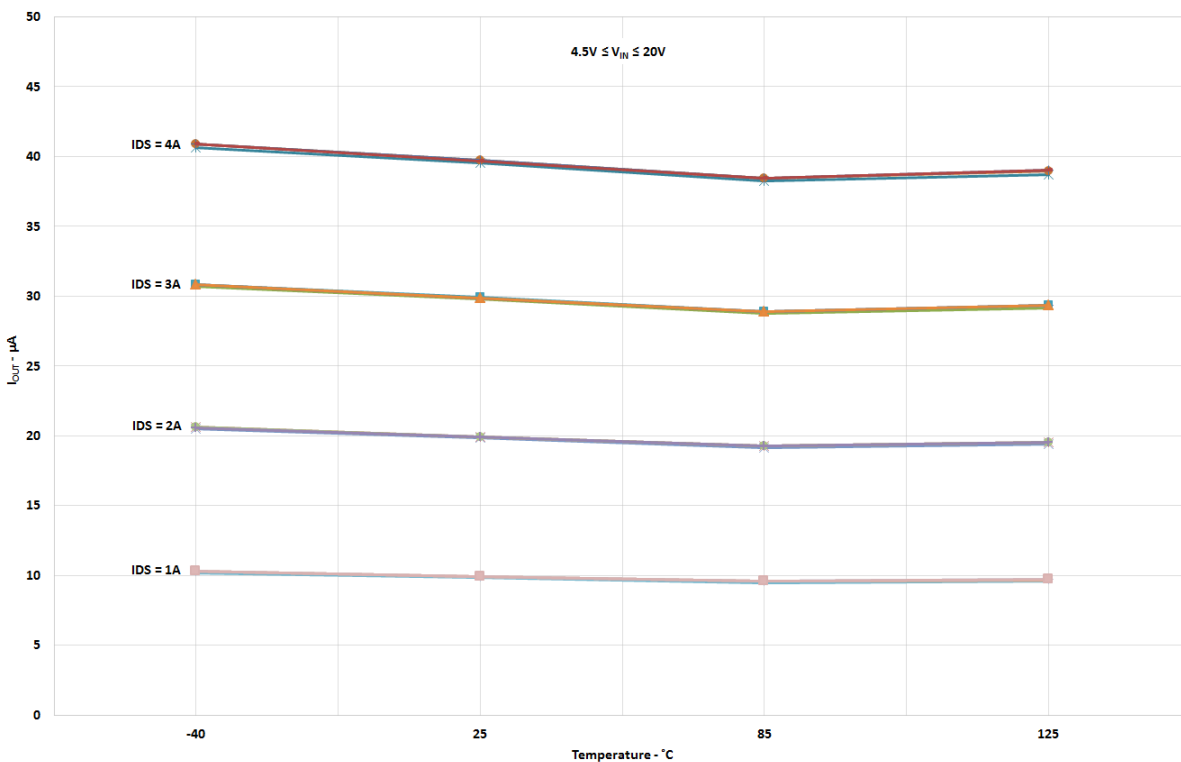



V_{OUT} Slew Rate vs. Temperature, V_{IN} , and C_{SLEW}

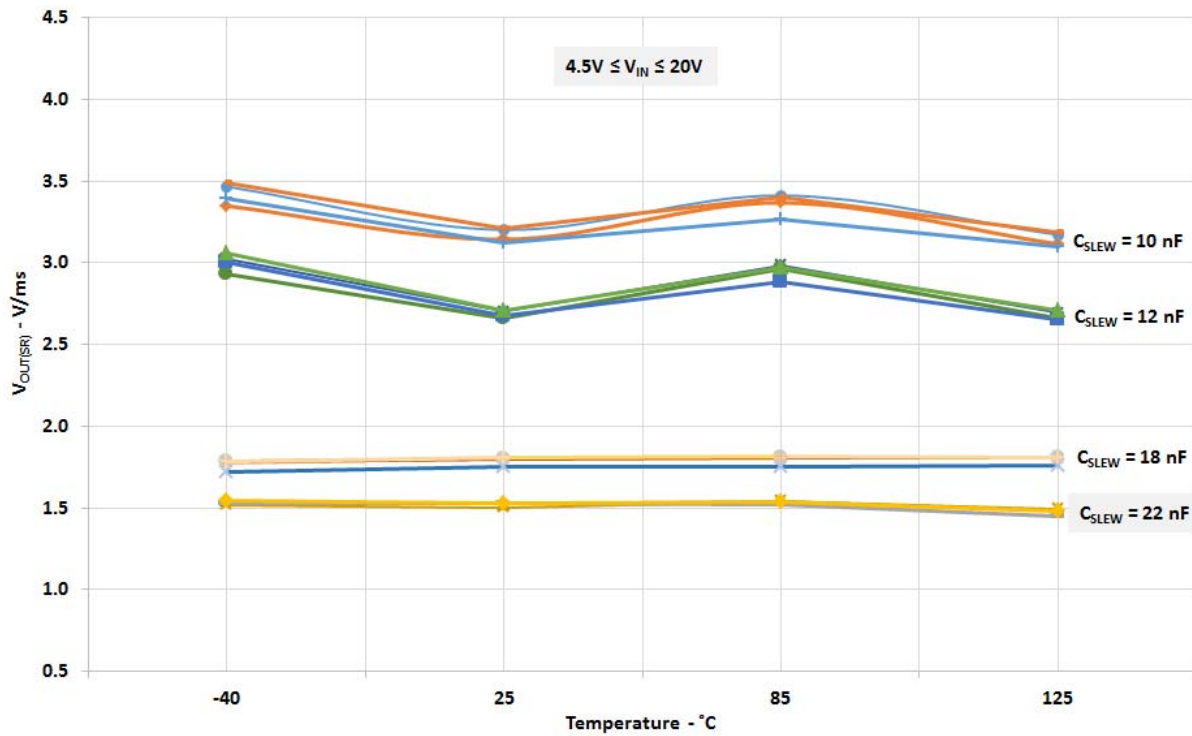

T_{Total_ON} vs. C_{SLEW} , V_{IN} , and Temperature

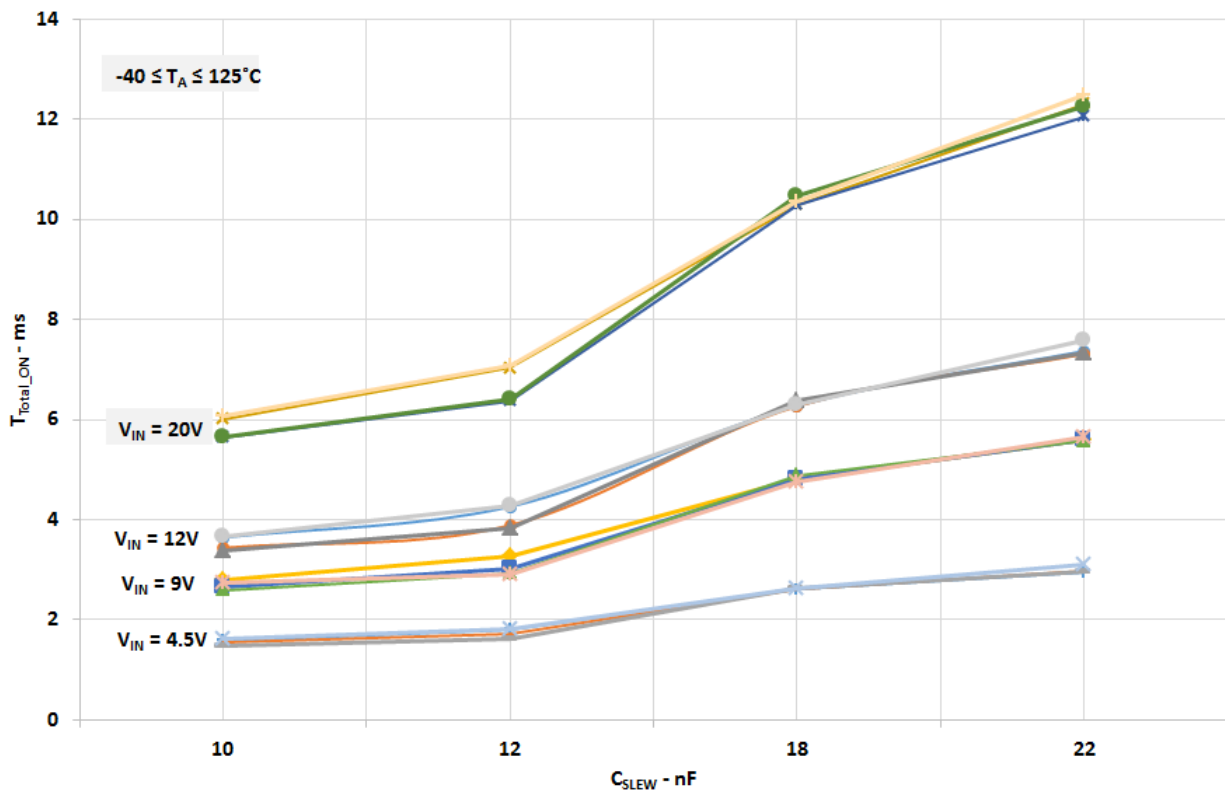



Typical Turn-on Waveforms - $V_{IN} = 4.5\text{ V}$

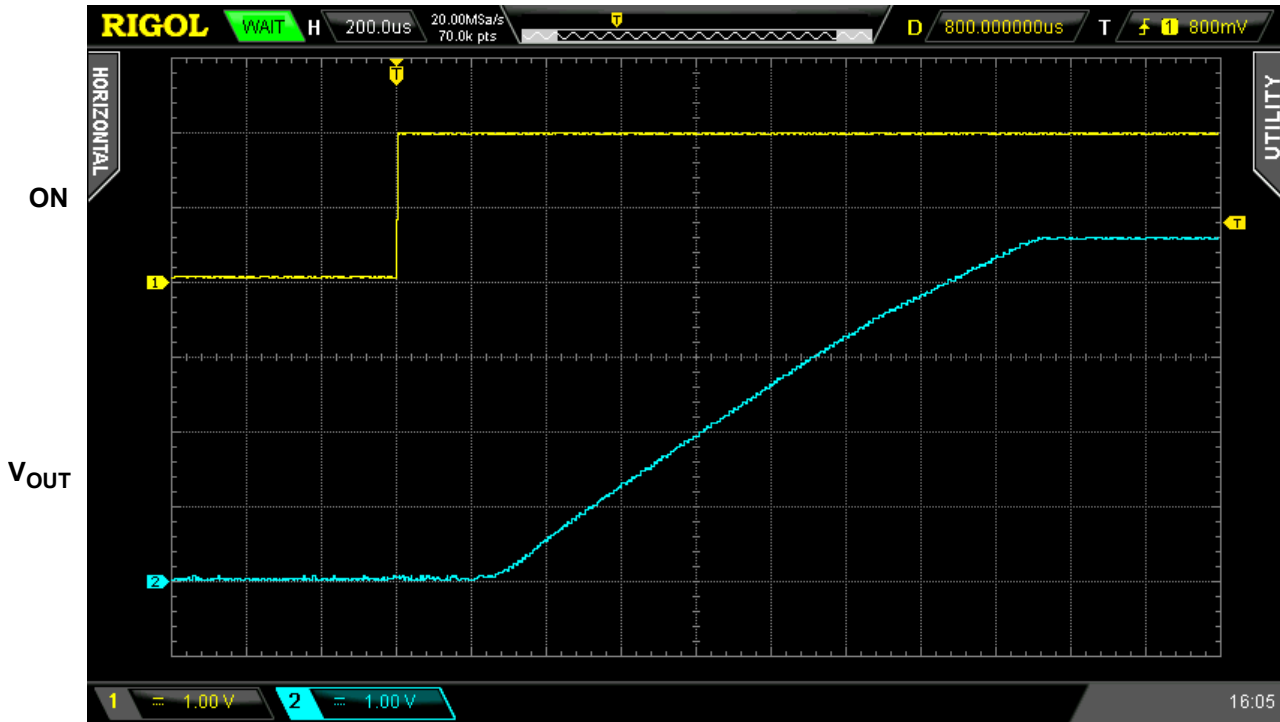

Figure 1. Typical Turn ON operation waveform for $V_{IN} = 4.5\text{ V}$, $C_{SLEW} = 10\text{ nF}$, $C_{LOAD} = 10\text{ }\mu\text{F}$, $R_{LOAD} = 100\text{ }\Omega$

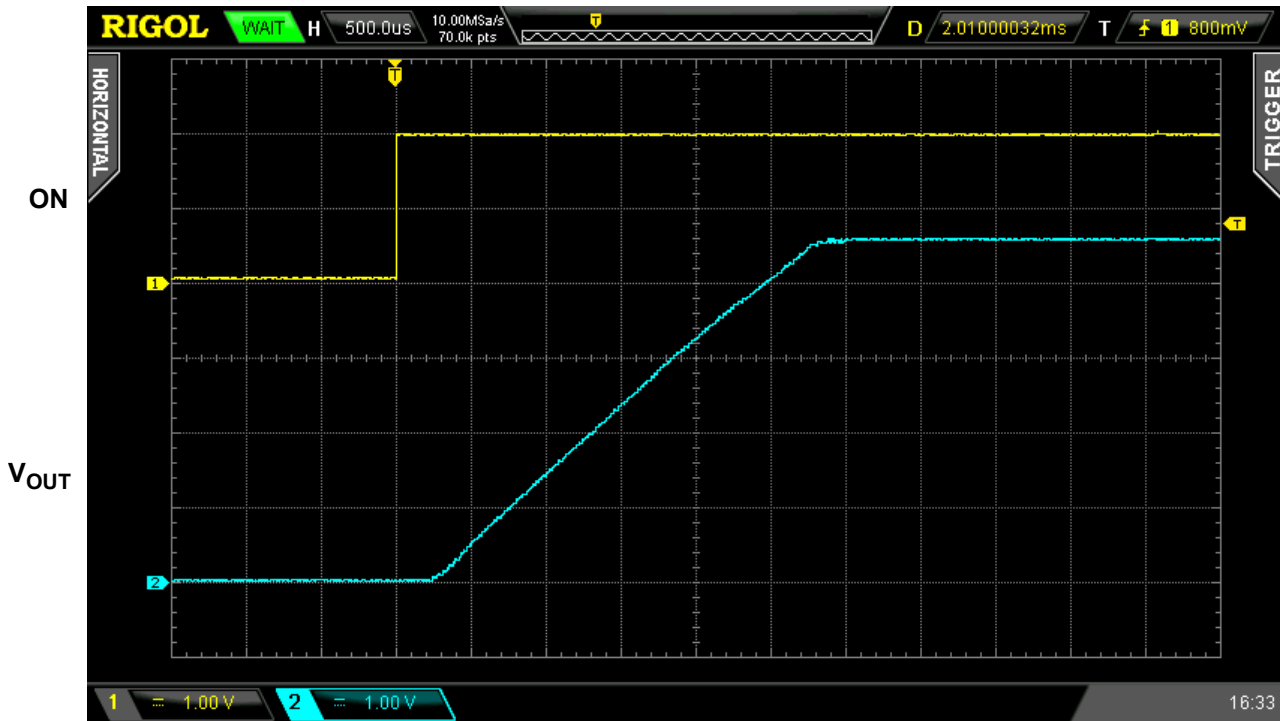

Figure 2. Typical Turn ON operation waveform for $V_{IN} = 4.5\text{ V}$, $C_{SLEW} = 18\text{ nF}$, $C_{LOAD} = 10\text{ }\mu\text{F}$, $R_{LOAD} = 100\text{ }\Omega$



Typical Turn-on Waveforms - $V_{IN} = 22\text{ V}$

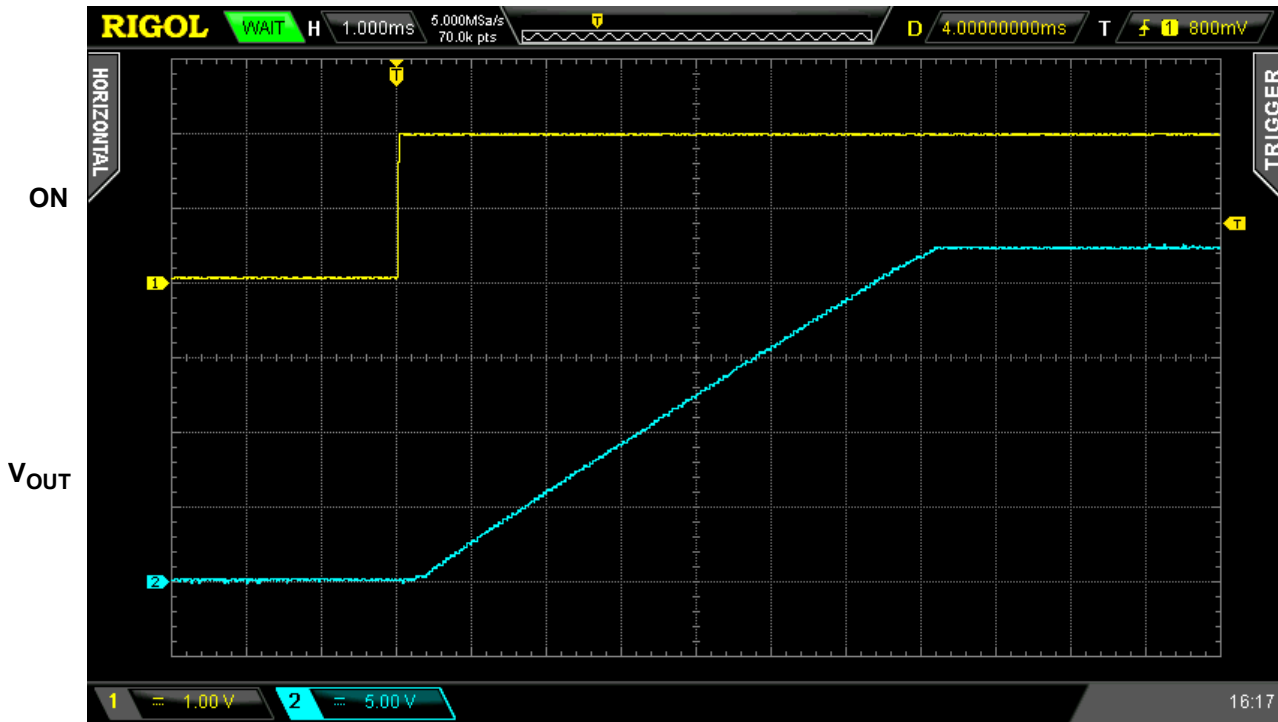

Figure 3. Typical Turn ON operation waveform for $V_{IN} = 22\text{ V}$, $C_{SLEW} = 10\text{ nF}$, $C_{LOAD} = 10\text{ }\mu\text{F}$, $R_{LOAD} = 100\text{ }\Omega$

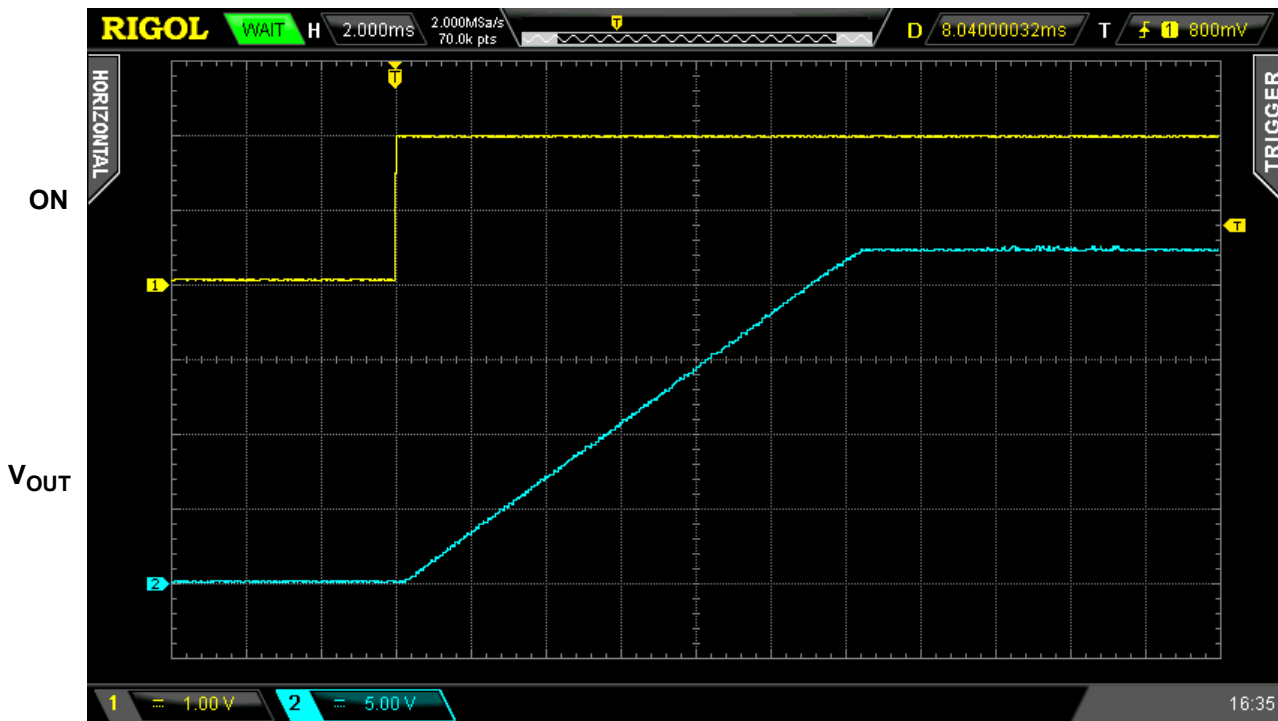

Figure 4. Typical Turn ON operation waveform for $V_{IN} = 22\text{ V}$, $C_{SLEW} = 18\text{ nF}$, $C_{LOAD} = 10\text{ }\mu\text{F}$, $R_{LOAD} = 100\text{ }\Omega$



Typical Turn-off Waveforms - $V_{IN} = 4.5\text{ V}$

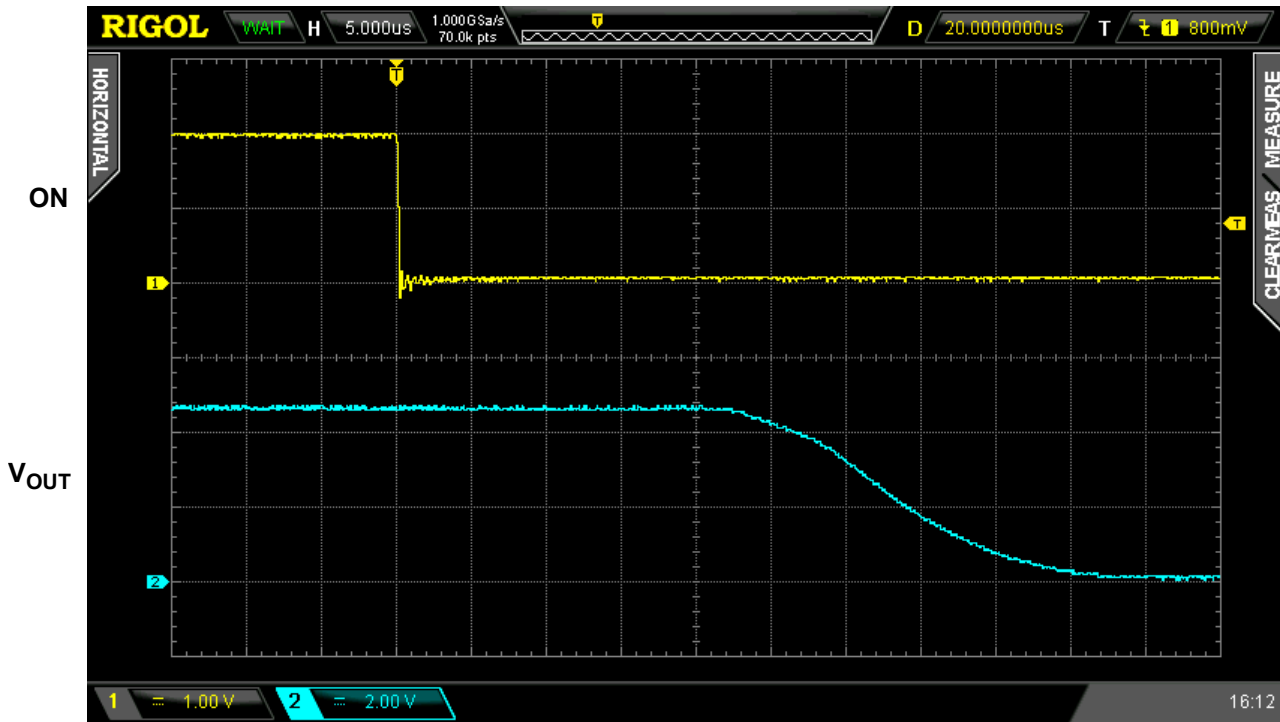

Figure 5. Typical Turn OFF operation waveform for $V_{IN} = 4.5\text{ V}$, $C_{SLEW} = 10\text{ nF}$, no C_{LOAD} , $R_{LOAD} = 100\ \Omega$

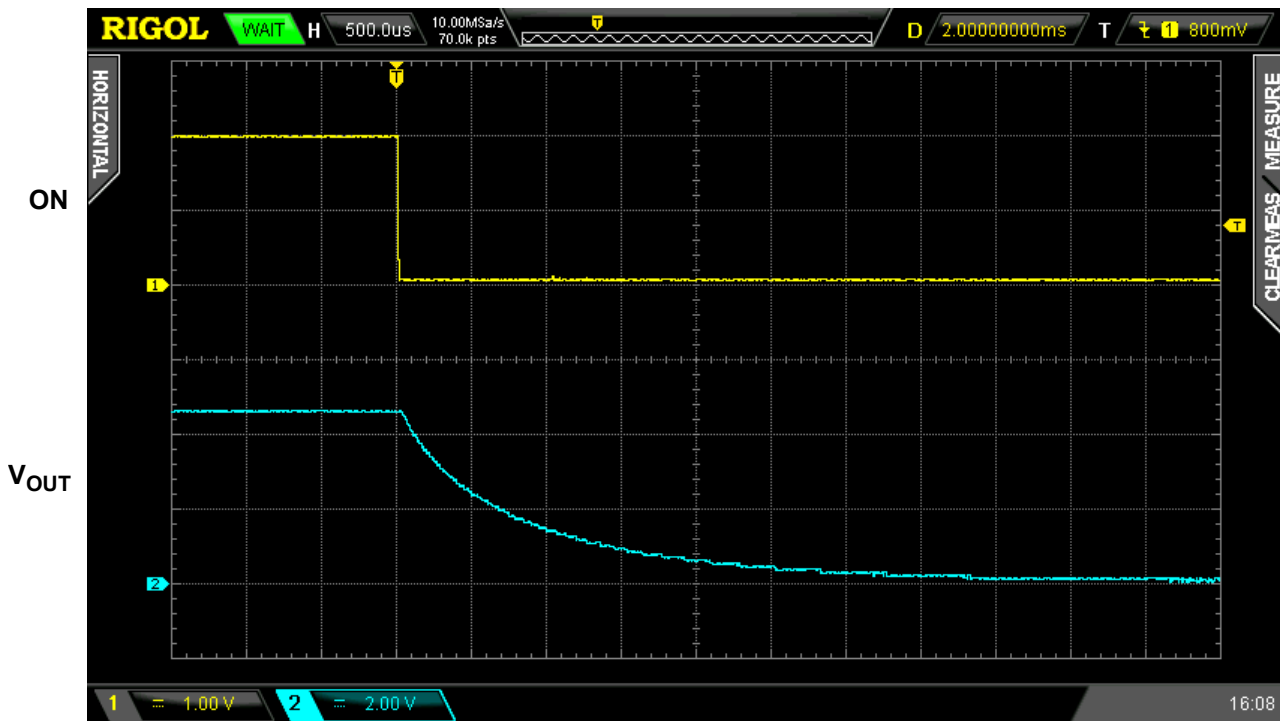

Figure 6. Typical Turn OFF operation waveform for $V_{IN} = 4.5\text{ V}$, $C_{SLEW} = 10\text{ nF}$, $C_{LOAD} = 10\ \mu\text{F}$, $R_{LOAD} = 100\ \Omega$



Typical Turn-off Waveforms - $V_{IN} = 22V$

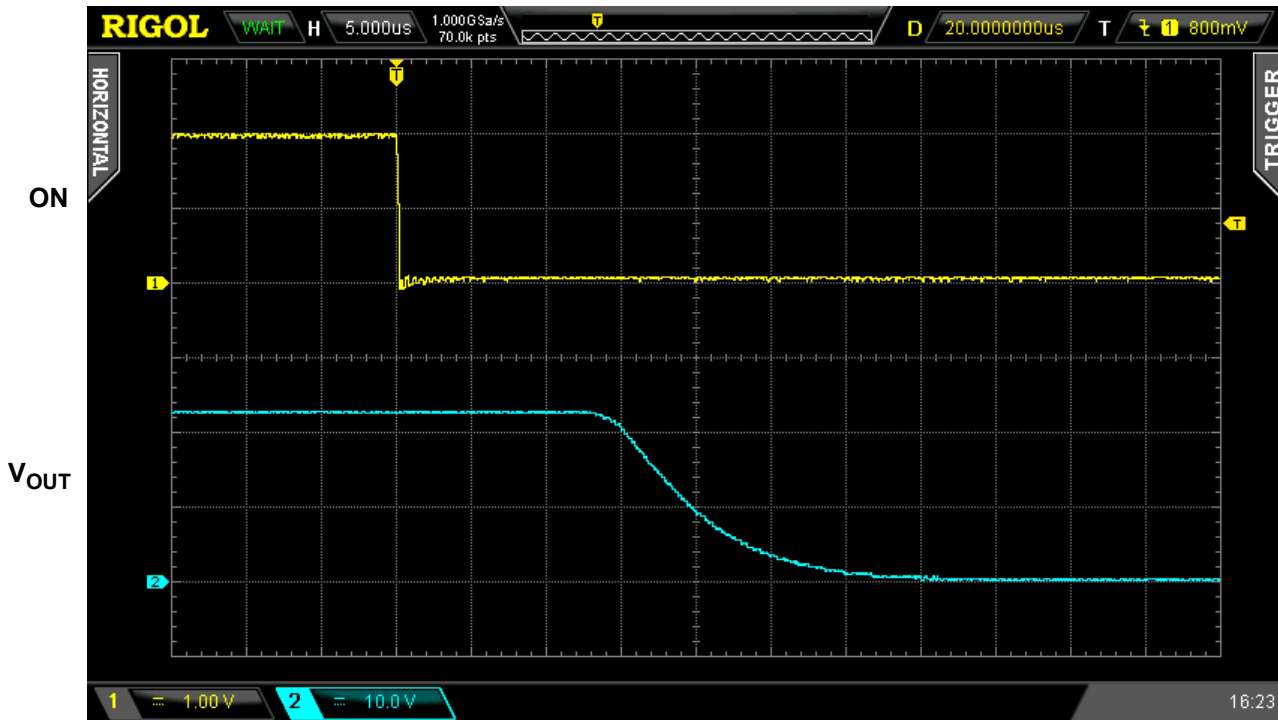

Figure 7. Typical Turn OFF operation waveform for $V_{IN} = 22V$, $C_{SLEW} = 10\text{ nF}$, no C_{LOAD} , $R_{LOAD} = 100\ \Omega$

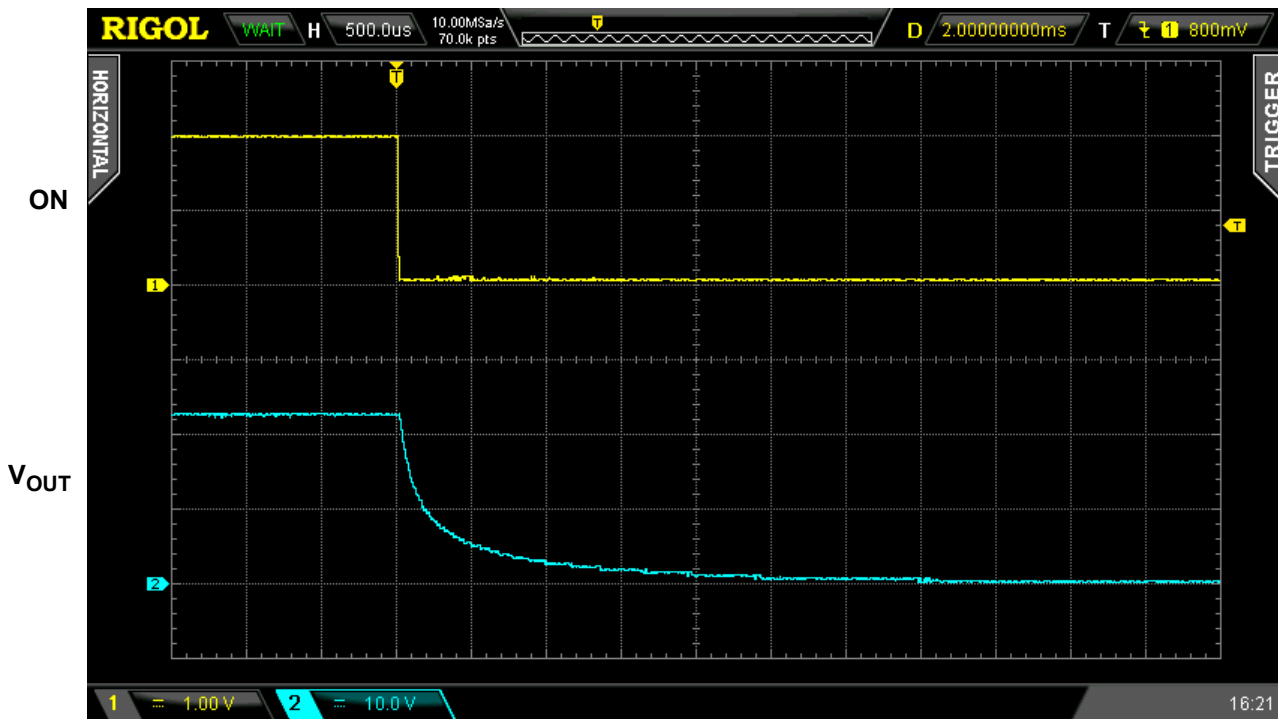
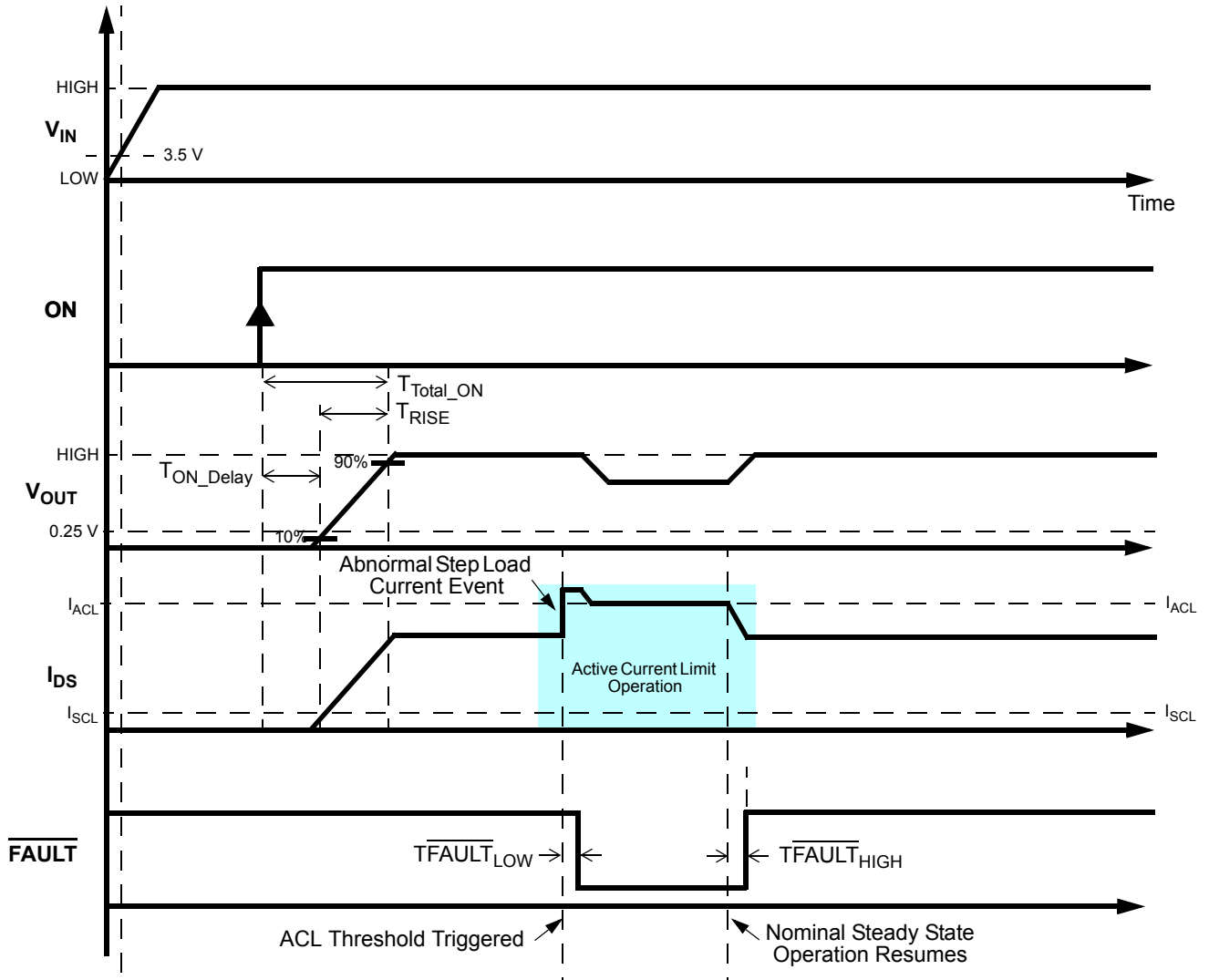

Figure 8. Typical Turn OFF operation waveform for $V_{IN} = 22V$, $C_{SLEW} = 10\text{ nF}$, $C_{LOAD} = 10\ \mu\text{F}$, $R_{LOAD} = 100\ \Omega$



Timing Diagram - Basic Operation including Active Current Limit Protection





Timing Diagram - Active Current Limit & Thermal Protection Operation

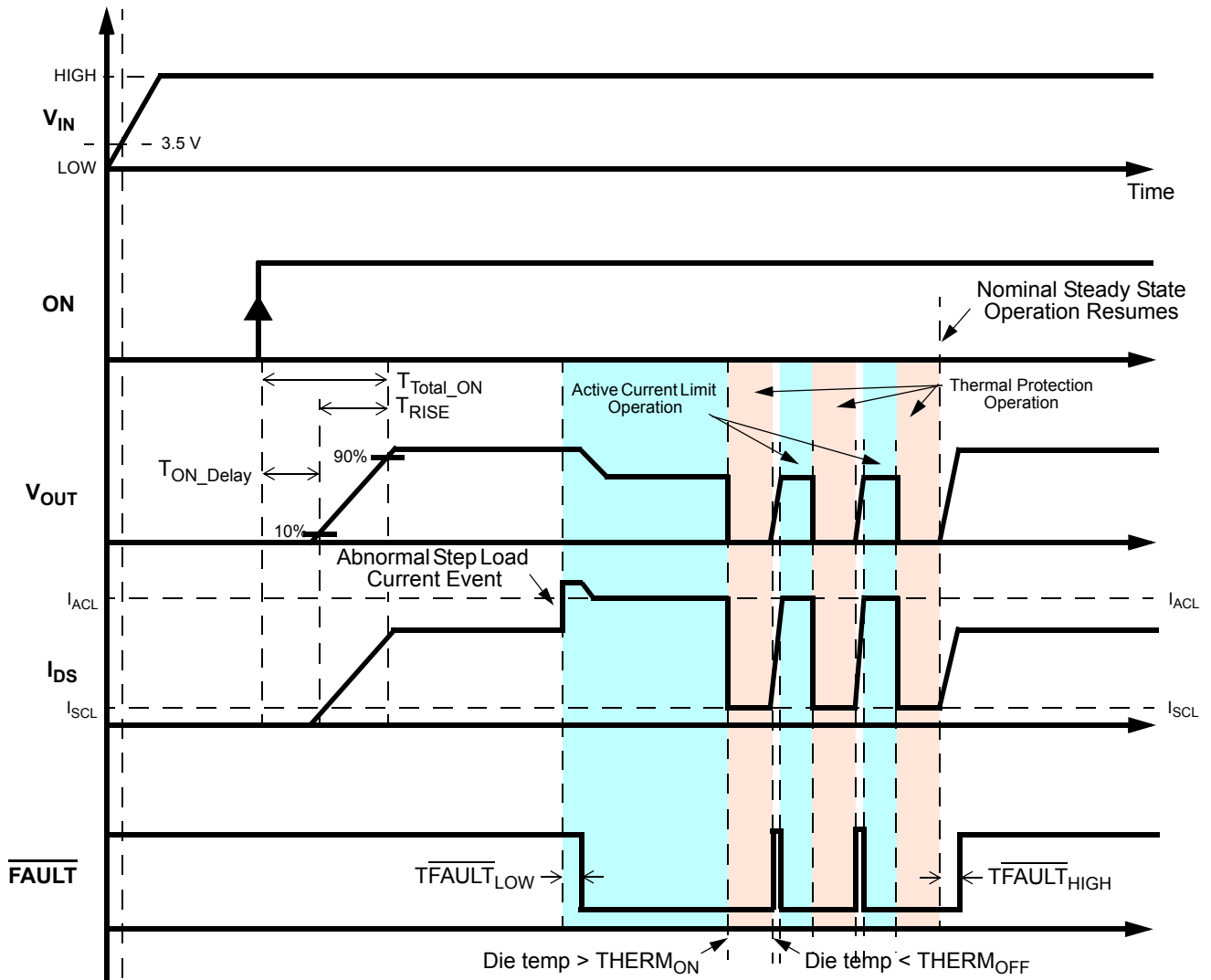



Timing Diagram - Basic Operation including Active Current + Internal FET SOA Protection

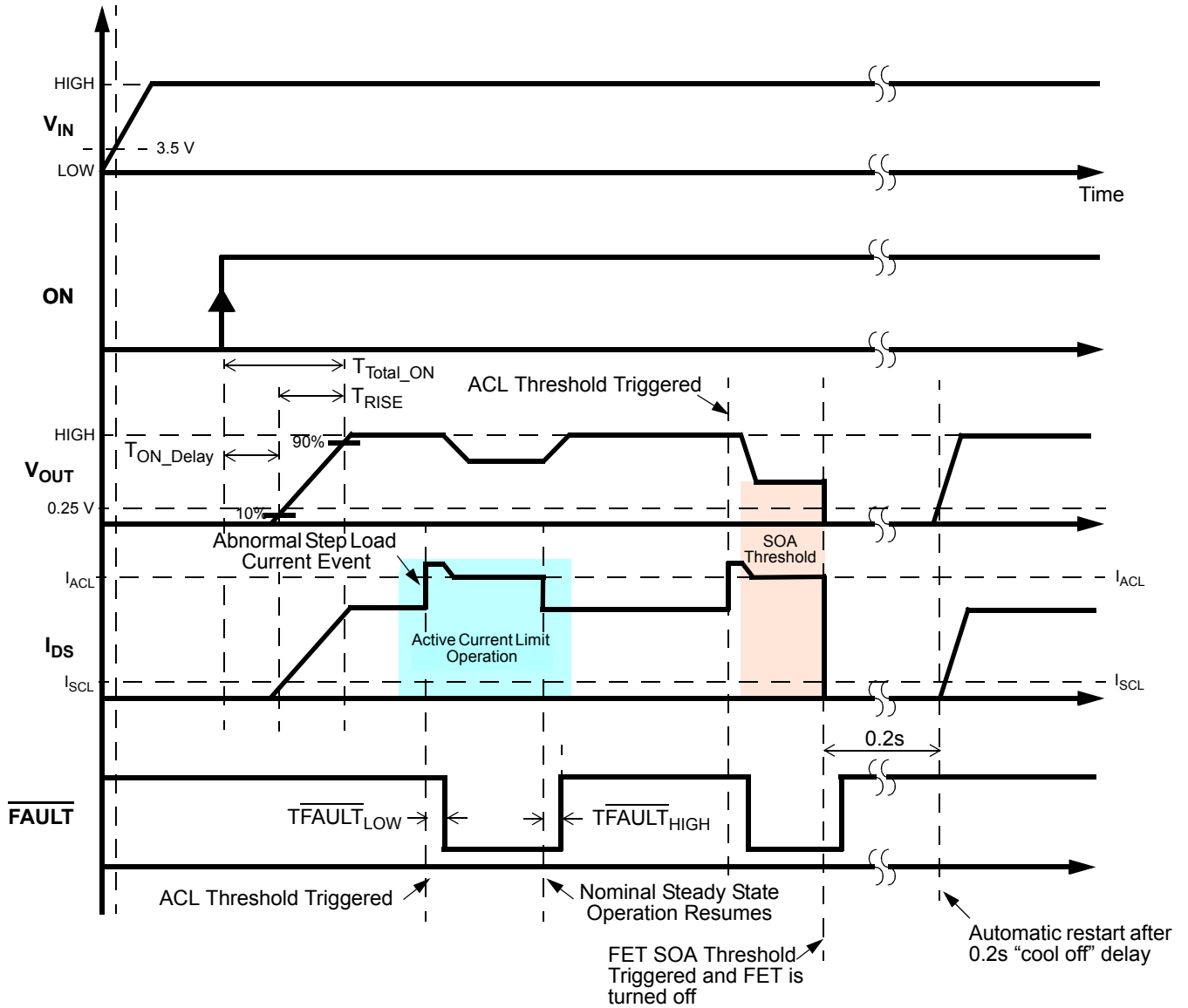



Applications Information

HFET1 Safe Operating Area Explained

Silego's HFET1 integrated power controllers incorporate a number of internal protection features that prevents them from damaging themselves or any other circuit or subcircuit downstream of them. One particular protection feature is their Safe Operation Area (SOA) protection. SOA protection is automatically activated under overpower and, in some cases, under overcurrent conditions. Overpower SOA is activated if package power dissipation exceeds an internal 5W threshold longer than 2.5 ms. HFET1 devices will quickly switch off (open circuit) upon overpower detection and automatically resume (close) nominal operation once overpower condition no longer exists.

One possible way to have an overpower condition trigger SOA protection is when HFET1 products are enabled into heavy output resistive loads and/or into large load capacitors. It is under these conditions to follow carefully the "Safe Start-up Loading" guidance in the Applications section of the datasheet. During an overcurrent condition, HFET1 devices will try to limit the output current to the level set by the external R_{SET} resistor. Limiting the output current, however, causes an increased voltage drop across the FET's channel because the FET's $R_{DS_{ON}}$ increased as well. Since the FET's $R_{DS_{ON}}$ is larger, package power dissipation also increases. If the resultant increase in package power dissipation is higher/equal than 5 W for longer than 2.5 ms, internal SOA protection will be triggered and the FET will open circuit (switch off). Every time SOA protection is triggered, all HFET1 devices will automatically attempt to resume nominal operation after 160 ms.

Safe Start-up Condition

SLG59H1016V has built-in protection to prevent over-heating during start-up into a heavy load. Overloading the VOUT pin with a capacitor and a resistor may result in non-monotonic V_{OUT} ramping. In general, under light loading on VOUT, V_{OUT} ramping can be controlled with C_{SLEW} value. The following equation serves as a guide:

$$C_{SLEW} = \frac{T_{RAMP}}{V_{IN}} \times 4.9 \mu A \times \frac{20}{3}$$

where

T_{RAMP} = Total ramping time for V_{OUT} to reach V_{IN}

V_{IN} = Input Voltage

C_{SLEW} = Capacitor value for CAP pin

When capacitor and resistor loading on VOUT during start up, the following tables will ensure V_{OUT} ramping is monotonic without triggering internal protection:

Safe Start-up Loading for $V_{IN} = 22 V$ (Monotonic Ramp)			
Slew Rate (V/ms)	C_{SLEW} Control (nF) ³	C_{LOAD} (μF)	R_{LOAD} (Ω)
0.5	66.7	500	80
1.0	33.3	250	80
1.5	22.2	160	80
2.0	16.7	120	80
2.5	13.3	100	80



Safe Start-up Loading for $V_{IN} = 12\text{ V}$ (Monotonic Ramp)			
Slew Rate (V/ms)	C_{SLEW} Control (nF) ³	C_{LOAD} (μF)	R_{LOAD} (Ω)
1	33.3	500	20
2	16.7	250	20
3	11.1	160	20
4	8.3	120	20
5	6.7	100	20

Note 3: Select the closest-value tolerance capacitor.

Setting the SLG59H1016V's Active Current Limit

R_{SET} (k Ω)	Active Current Limit (A)
95	1
45	2
30	3
23.5	4

Setting the SLG59H1016V's Input Overvoltage Lockout Threshold

As shown in the table below, SEL[1,0] selects the V_{IN} overvoltage threshold at which the SLG59H1016V's internal state machine will turn OFF (open circuit) the power MOSFET if V_{IN} exceeds the selected threshold.

SEL1	SEL0	$V_{IN(OVLO)}$ (Typ)
0	0	6 V
0	1	10.8 V
1	0	14.4 V
1	1	24 V

For example, SEL[1,1] would be the most appropriate setting for applications where the steady-state V_{IN} can extend up to 20 V without causing any damage to the SLG59H1016V since the IC is 29-V tolerant.

With an activated SLG59H1016V (ON=HIGH) and at any time V_{IN} crosses the programmed V_{IN} overvoltage threshold, the state machine opens the power switch and asserts the $\overline{\text{FAULT}}$ pin within $T_{\text{FAULT_LOW}}$.

In applications with a deactivated or inactive SLG59H1016V ($V_{IN} > V_{IN(UVLO)}$ and ON=LOW) and if the applied V_{IN} is higher than the programmed $V_{IN(OVLO)}$ threshold, the SLG59H1016V's state machine will keep the power switch open circuited if the ON pin is toggled LOW-to-HIGH. In these cases, the $\overline{\text{FAULT}}$ pin will also be asserted within $T_{\text{FAULT_LOW}}$ and will remain asserted until V_{IN} resumes nominal, steady-state operation.

In all cases, the SLG59H1016V's V_{IN} undervoltage lockout threshold is fixed at $V_{IN(UVLO)}$.



Power Dissipation

The junction temperature of the SLG59H1016V depends on different factors such as board layout, ambient temperature, and other environmental factors. The primary contributor to the increase in the junction temperature of the SLG59H1016V is the power dissipation of its power MOSFET. Its power dissipation and the junction temperature in nominal operating mode can be calculated using the following equations:

$$PD = RDS_{ON} \times I_{DS}^2$$

where:

PD = Power dissipation, in Watts (W)

RDS_{ON} = Power MOSFET ON resistance, in Ohms (Ω)

I_{DS} = Output current, in Amps (A)

and

$$T_J = PD \times \theta_{JA} + T_A$$

where:

T_J = Junction temperature, in Celsius degrees ($^{\circ}C$)

θ_{JA} = Package thermal resistance, in Celsius degrees per Watt ($^{\circ}C/W$)

T_A = Ambient temperature, in Celsius degrees ($^{\circ}C$)

In current-limit mode, the SLG59H1016V's power dissipation can be calculated by taking into account the voltage drop across the power switch ($V_{IN} - V_{OUT}$) and the magnitude of the output current in current-limit mode (I_{ACL}):

$$PD = (V_{IN} - V_{OUT}) \times I_{ACL} \text{ or}$$

$$PD = (V_{IN} - (R_{LOAD} \times I_{ACL})) \times I_{ACL}$$

where:

PD = Power dissipation, in Watts (W)

V_{IN} = Input Voltage, in Volts (V)

R_{LOAD} = Load Resistance, in Ohms (Ω)

I_{ACL} = Output limited current, in Amps (A)

$V_{OUT} = R_{LOAD} \times I_{ACL}$



Package Top Marking System Definition

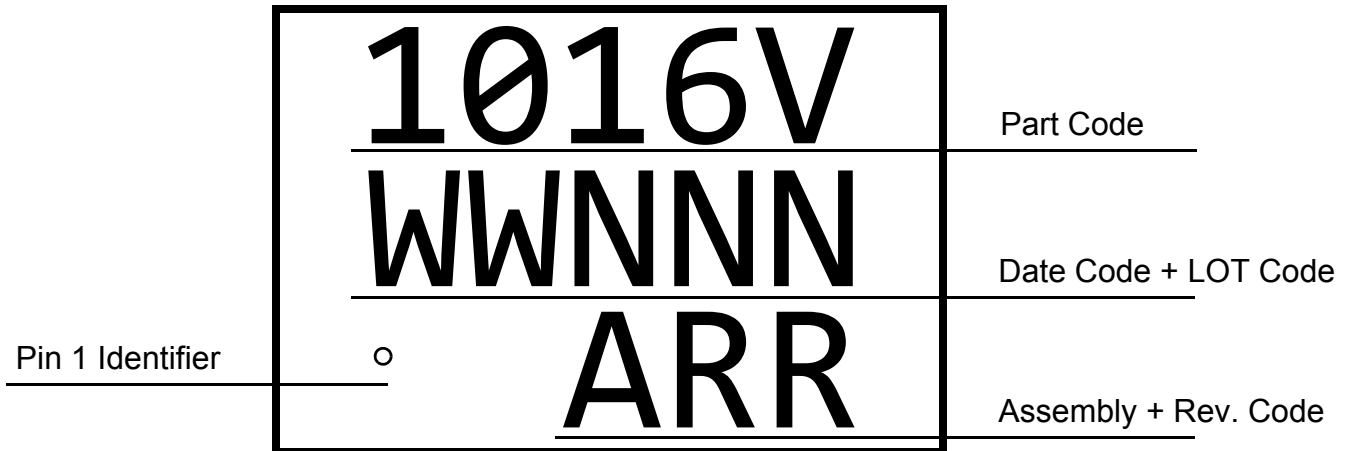

- 1016V - Part ID Field
- WW - Date Code Field¹
- NNN - Lot Traceability Code Field¹
- A - Assembly Site Code Field²
- RR - Part Revision Code Field²

Note 1: Each character in code field can be alphanumeric A-Z and 0-9
Note 2: Character in code field can be alphabetic A-Z



Package Drawing and Dimensions

18 Lead TQFN Package 1.6 x 3 mm (Fused Lead)
JEDEC MO-220, Variation WCEE

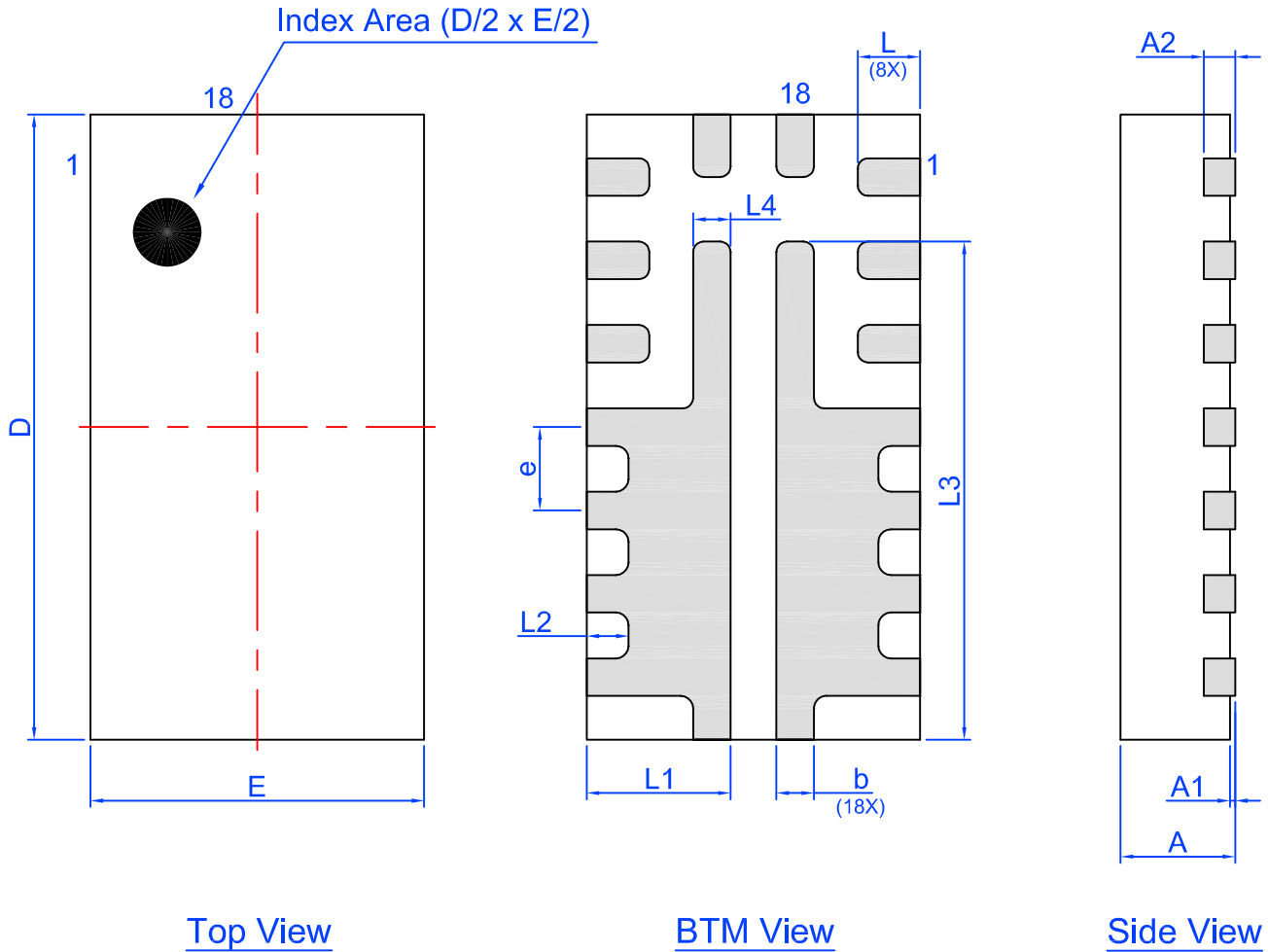

Unit: mm

Symbol	Min	Nom.	Max	Symbol	Min	Nom.	Max
A	0.50	0.55	0.60	D	2.95	3.00	3.05
A1	0.005	-	0.05	E	1.55	1.60	1.65
A2	0.10	0.15	0.20	L	0.25	0.30	0.35
b	0.13	0.18	0.23	L1	0.64	0.69	0.74
e	0.40 BSC			L2	0.15	0.20	0.25
L3	2.34	2.39	2.44	L4	0.13	0.18	0.23



Tape and Reel Specifications

Package Type	# of Pins	Nominal Package Size [mm]	Max Units		Reel & Hub Size [mm]	Leader (min)		Trailer (min)		Tape Width [mm]	Part Pitch [mm]
			per Reel	per Box		Pockets	Length [mm]	Pockets	Length [mm]		
STQFN 18L 0.4P FC Green	18	1.6 x 3 x 0.55	3,000	3,000	178 / 60	100	400	100	400	8	4

Carrier Tape Drawing and Dimensions

Package Type	Pocket BTM Length	Pocket BTM Width	Pocket Depth	Index Hole Pitch	Pocket Pitch	Index Hole Diameter	Index Hole to Tape Edge	Index Hole to Pocket Center	Tape Width
	A0	B0	K0	P0	P1	D0	E	F	W
STQFN 18L 0.4P FC Green	1.78	3.18	0.76	4	4	1.5	1.75	3.5	8

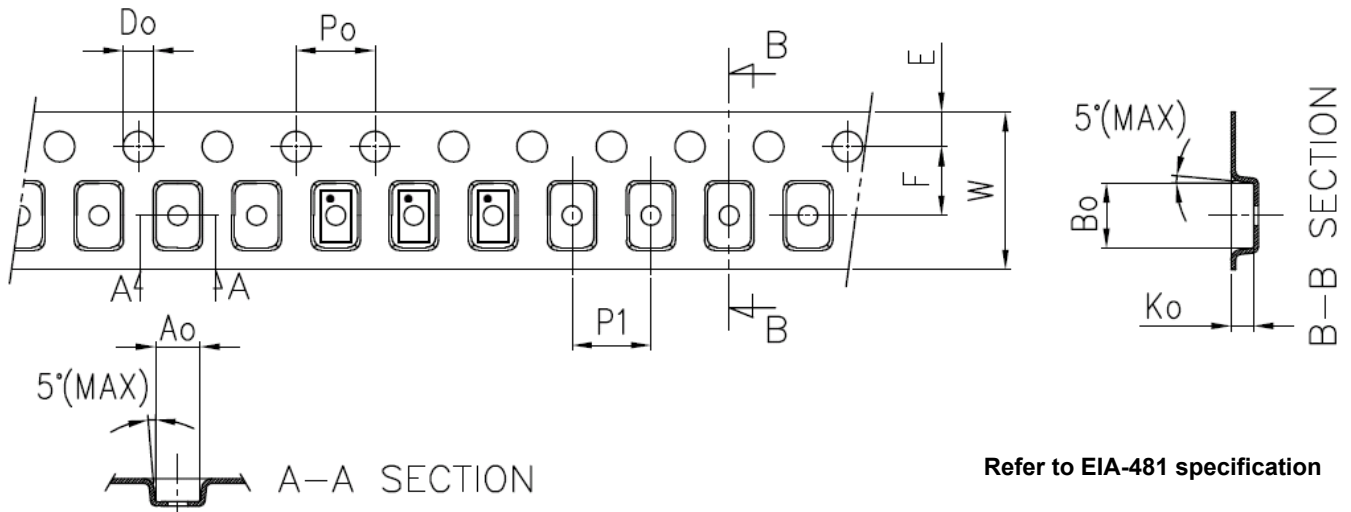

Refer to EIA-481 specification

Recommended Reflow Soldering Profile

Please see IPC/JEDEC J-STD-020: latest revision for reflow profile based on package volume of 2.64 mm³ (nominal). More information can be found at www.jedec.org.



Revision History

Date	Version	Change
2/24/2017	1.00	Production Release

Компания «Life Electronics» занимается поставками электронных компонентов импортного и отечественного производства от производителей и со складов крупных дистрибьюторов Европы, Америки и Азии.

С конца 2013 года компания активно расширяет линейку поставок компонентов по направлению коаксиальный кабель, кварцевые генераторы и конденсаторы (керамические, пленочные, электролитические), за счёт заключения дистрибьюторских договоров

Мы предлагаем:

- Конкурентоспособные цены и скидки постоянным клиентам.
- Специальные условия для постоянных клиентов.
- Подбор аналогов.
- Поставку компонентов в любых объемах, удовлетворяющих вашим потребностям.
- Приемлемые сроки поставки, возможна ускоренная поставка.
- Доставку товара в любую точку России и стран СНГ.
- Комплексную поставку.
- Работу по проектам и поставку образцов.
- Формирование склада под заказчика.
- Сертификаты соответствия на поставляемую продукцию (по желанию клиента).
- Тестирование поставляемой продукции.
- Поставку компонентов, требующих военную и космическую приемку.
- Входной контроль качества.
- Наличие сертификата ISO.

В составе нашей компании организован Конструкторский отдел, призванный помогать разработчикам, и инженерам.

Конструкторский отдел помогает осуществить:

- Регистрацию проекта у производителя компонентов.
- Техническую поддержку проекта.
- Защиту от снятия компонента с производства.
- Оценку стоимости проекта по компонентам.
- Изготовление тестовой платы монтаж и пусконаладочные работы.



Тел: +7 (812) 336 43 04 (многоканальный)
Email: org@lifeelectronics.ru