

Optocoupler, Phototransistor Output, Low Input Current, With Base Connection, 5300 V_{RMS}

Features

- Very High CTR at $I_F = 1.0 \text{ mA}$, $V_{CE} = 0.5 \text{ V}$
- Specified Minimum CTR at $I_F = 0.5 \text{ mA}$,
- $V_{CE} = 1.5 \text{ V} \geq 32 \%$ (typ. 120 %)
- Good CTR Linearity with Forward Current
- Low CTR Degradation
- High Collector-Emitter Voltage $V_{CEO} = 55 \text{ V}$
- Isolation Test Voltage: 5300 V_{RMS}
- Low Current Input
- Low Coupling Capacitance
- High Common Mode Transient Immunity
- Lead-free component
- Component in accordance to RoHS 2002/95/EC and WEEE 2002/96/EC

Agency Approvals

- UL1577, File No. E52744 System Code H or J, Double Protection
- DIN EN 60747-5-2 (VDE0884)
DIN EN 60747-5-5 pending
Available with Option 1
- CSA 93751
- BSI IEC60950 IEC60065

Applications

Telecommunications
Industrial Controls
Office Machines
Microprocessor System Interfaces

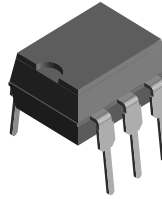

1179004

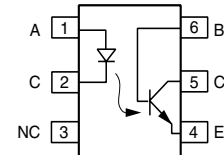

Description

The SFH 608 is an optocoupler designed for high current transfer ratio at low input currents with the output transistor saturated. This makes the device ideal for low current switching applications. The SFH608 is packaged in a six pin plastic DIP.

Order Information

Part	Remarks
SFH608-2	CTR 63 - 125 %, DIP-6
SFH608-3	CTR 100 - 200 %, DIP-6
SFH608-4	CTR 160 - 320 %, DIP-6
SFH608-5	CTR 250 - 500 %, DIP-6
SFH608-2-X006	CTR 63 - 125 %, DIP-6 400 mil (option 6)
SFH608-2-X007	CTR 63 - 125 %, SMD-6 (option 7)
SFH608-2-X009	CTR 63 - 125 %, SMD-6 (option 9)
SFH608-3-X006	CTR 100 - 200 %, DIP-6 400 mil (option 6)
SFH608-3-X007	CTR 100 - 200 %, SMD-6 (option 7)
SFH608-4-X006	CTR 160 - 320 %, DIP-6 400 mil (option 6)
SFH608-4-X007	CTR 160 - 320 %, SMD-6 (option 7)
SFH608-5-X007	CTR 250 - 500 %, SMD-6 (option 7)

For additional information on the available options refer to Option Information.

Absolute Maximum Ratings

$T_{amb} = 25\text{ }^{\circ}\text{C}$, unless otherwise specified

Stresses in excess of the absolute Maximum Ratings can cause permanent damage to the device. Functional operation of the device is not implied at these or any other conditions in excess of those given in the operational sections of this document. Exposure to absolute Maximum Rating for extended periods of the time can adversely affect reliability.

Input

Parameter	Test condition	Symbol	Value	Unit
Reverse voltage		V_R	6.0	V
DC Forward current		I_F	50	mA
Surge forward current	$t \leq 10\text{ }\mu\text{s}$	I_{FSM}	2.5	A
Total power dissipation		P_{diss}	70	mW

Output

Parameter	Test condition	Symbol	Value	Unit
Collector-emitter voltage		V_{CE}	55	V
Collector-base voltage		V_{CBO}	55	V
Emitter-base voltage		V_{EBO}	7.0	V
Collector current		I_C	50	mA
Surge collector current	$t_p \leq 1.0\text{ ms}$		100	mA
Total power dissipation		P_{diss}	150	mW

Coupler

Parameter	Test condition	Symbol	Value	Unit
Isolation test voltage (between emitter and detector, refer to climate DIN 40046 part 2 Nov. 74)	$t = 1.0\text{ s}$	V_{ISO}	5300	V_{RMS}
Creepage			≥ 7.0	mm
Clearance			≥ 7.0	mm
Comparative tracking index per DIN IEC 112/VDE 0303, part 1			175	
Isolation resistance	$V_{IO} = 500\text{ V}, T_{amb} = 25\text{ }^{\circ}\text{C}$	R_{IO}	$\geq 10^{12}$	Ω
	$V_{IO} = 500\text{ V}, T_{amb} = 100\text{ }^{\circ}\text{C}$	R_{IO}	$\geq 10^{11}$	Ω
Storage temperature range		T_{stg}	- 55 to + 150	$^{\circ}\text{C}$
Operating temperature range		T_{amb}	- 55 to + 100	$^{\circ}\text{C}$
Soldering temperature	max. 10 s, dip soldering: distance to seating plane $\geq 1.5\text{ mm}$	T_{sld}	260	$^{\circ}\text{C}$

Electrical Characteristics

$T_{amb} = 25\text{ }^{\circ}\text{C}$, unless otherwise specified

Minimum and maximum values are testing requirements. Typical values are characteristics of the device and are the result of engineering evaluation. Typical values are for information only and are not part of the testing requirements.

Input

Parameter	Test condition	Symbol	Min	Typ.	Max	Unit
Forward voltage	$I_F = 5.0\text{ mA}$	V_F		1.1	1.5	V
Reverse voltage	$I_R = 10\text{ }\mu\text{A}$	V_R	6.0			V
Reverse current	$V_R = 6.0\text{ V}$	I_R		0.01	10	μA
Capacitance	$V_R = 0\text{ V}$, $f = 1.0\text{ MHz}$	C_O		25		pF
Thermal resistance		R_{thja}		1070		K/W

Output

Parameter	Test condition	Symbol	Min	Typ.	Max	Unit
Voltage, collector-emitter	$I_{CE} = 10\text{ }\mu\text{A}$	V_{CEO}	55			V
Voltage, emitter-base	$I_{EB} = 10\text{ }\mu\text{A}$	V_{EBO}	7.0			V
Collector-emitter capacitance	$V_{CE} = 5.0$, $f = 1.0\text{ MHz}$	C_{CE}		10		pF
Collector - base capacitance	$V_{CE} = 5.0$, $f = 1.0\text{ MHz}$	C_{CB}		16		pF
Emitter - base capacitance	$V_{CE} = 5.0$, $f = 1.0\text{ MHz}$	C_{EB}		10		pF
Thermal resistance		R_{thja}		500		K/W
Collector-emitter leakage current	$V_{CE} = 10\text{ V}$	I_{CEO}		10	200	nA

Coupler

Parameter	Test condition	Part	Symbol	Min	Typ.	Max	Unit
Coupling capacitance			C_C		0.60		pF
Saturation voltage, collector-emitter	$I_C = 0.32\text{ mA}$, $I_F = 1.0\text{ mA}$	SFH608-2	V_{CEsat}		0.25	0.4	V
	$I_C = 0.5\text{ mA}$, $I_F = 1.0\text{ mA}$	SFH608-3	V_{CEsat}		0.25	0.4	V
	$I_C = 0.8\text{ mA}$, $I_F = 1.0\text{ mA}$	SFH608-4	V_{CEsat}		0.25	0.4	V
	$I_C = 0.125\text{ mA}$, $I_F = 1.0\text{ mA}$	SFH608-5	V_{CEsat}		0.25	0.4	V

Current Transfer Ratio

Parameter	Test condition	Part	Symbol	Min	Typ.	Max	Unit
Coupling Transfer Ratio	$I_F = 1.0\text{ mA}$, $V_{CE} = 0.5\text{ V}$	SFH608-2	CTR	63		125	%
	$I_F = 0.5\text{ mA}$, $V_{CE} = 1.5\text{ V}$	SFH608-2	CTR	32	75		%
	$I_F = 1.0\text{ mA}$, $V_{CE} = 0.5\text{ V}$	SFH608-3	CTR	100		200	%
	$I_F = 0.5\text{ mA}$, $V_{CE} = 1.5\text{ V}$	SFH608-3	CTR	50	120		%
	$I_F = 1.0\text{ mA}$, $V_{CE} = 0.5\text{ V}$	SFH608-4	CTR	160		320	%
	$I_F = 0.5\text{ mA}$, $V_{CE} = 1.5\text{ V}$	SFH608-4	CTR	80	200		%
	$I_F = 1.0\text{ mA}$, $V_{CE} = 0.5\text{ V}$	SFH608-5	CTR	250		500	%
	$I_F = 0.5\text{ mA}$, $V_{CE} = 1.5\text{ V}$	SFH608-5	CTR	125	300		%

Switching Characteristics

Parameter	Test condition	Symbol	Min	Typ.	Max	Unit
Turn-on time	$I_C = 2.0 \text{ mA}$ (to adjust by I_F), $R_L = 100 \Omega$, $V_{CC} = 5.0 \text{ V}$	t_{on}		8.0		μs
Rise time	$I_C = 2.0 \text{ mA}$ (to adjust by I_F), $R_L = 100 \Omega$, $V_{CC} = 5.0 \text{ V}$	t_r		5.0		μs
Turn-off time	$I_C = 2.0 \text{ mA}$ (to adjust by I_F), $R_L = 100 \Omega$, $V_{CC} = 5.0 \text{ V}$	t_{off}		7.5		μs
Fall time	$I_C = 2.0 \text{ mA}$ (to adjust by I_F), $R_L = 100 \Omega$, $V_{CC} = 5.0 \text{ V}$	t_f		7.0		μs

Typical Characteristics ($T_{amb} = 25 \text{ }^\circ\text{C}$ unless otherwise specified)

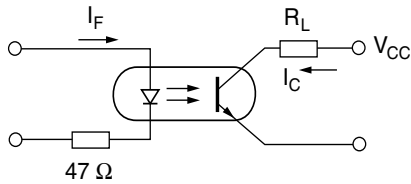

Figure 1. Switching Schematic

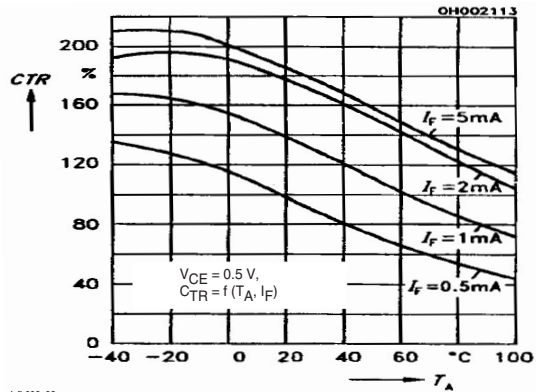

Figure 3. Current Transfer Ratio (typ.)

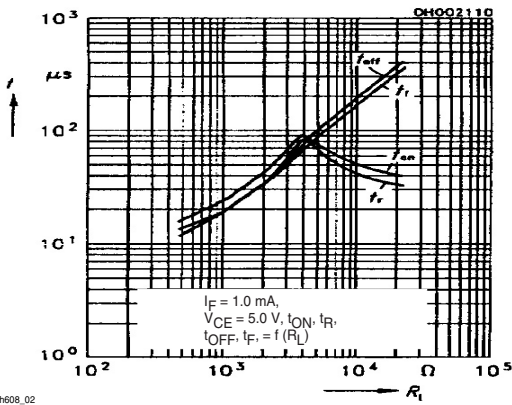

Figure 2. Switching Times

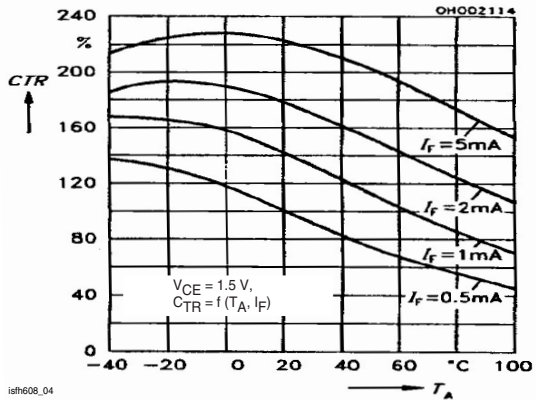
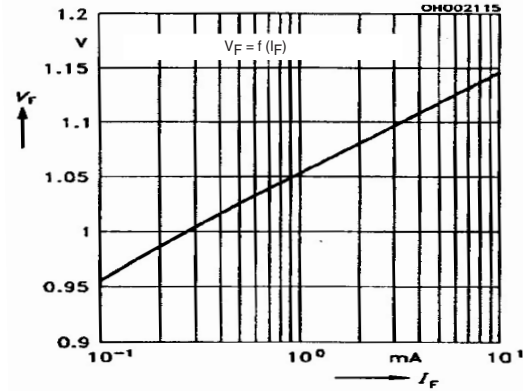
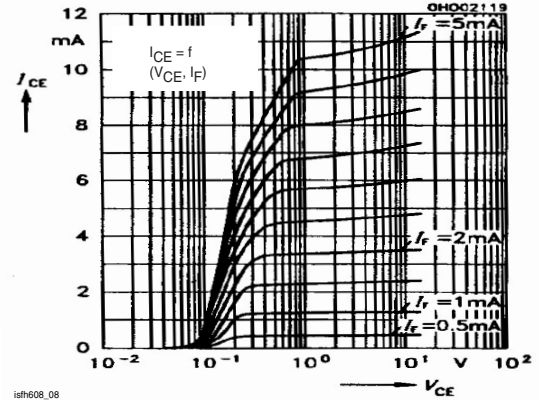

Figure 4. Current Transfer Ratio (typ.)



isth608_05

Figure 5. Diode Forward Voltage (typ.)



isth608_08

Figure 8. Output Characteristics

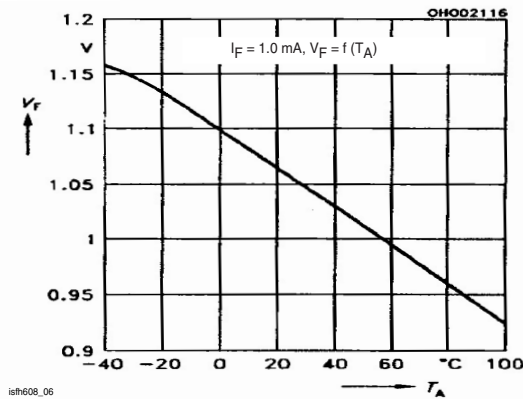

isth608_06

Figure 6. Diode Forward Voltage (typ.)

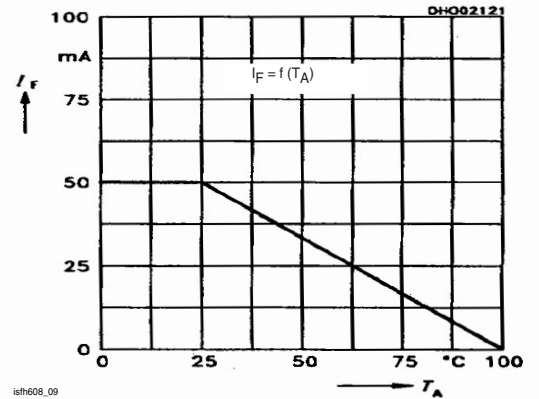

isth608_09

Figure 9. Permissible Forward Current Diode

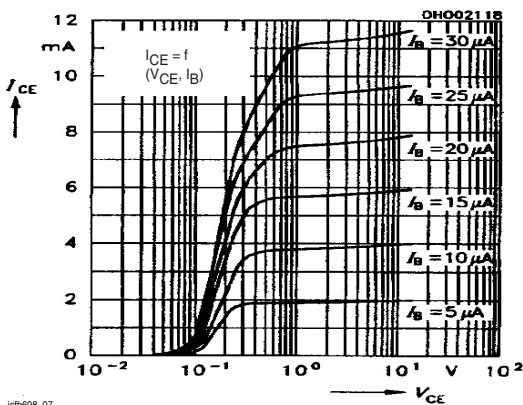

isth608_07

Figure 7. Output Characteristics

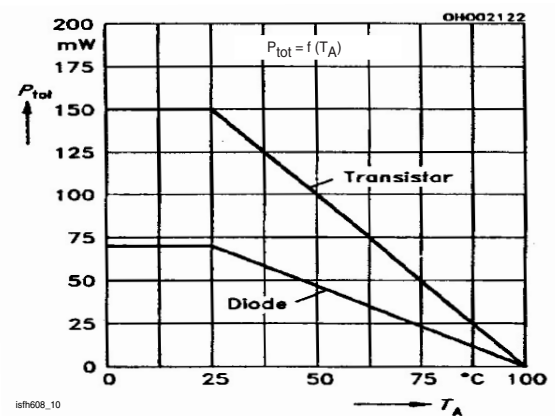

isth608_10

Figure 10. Permissible Power Dissipation for Transistor and Diode

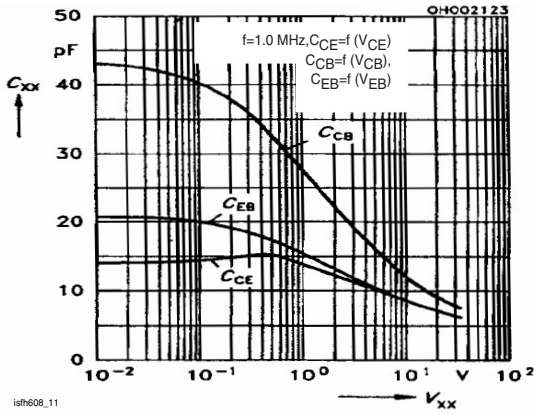

Figure 11. Transistor Capacitance

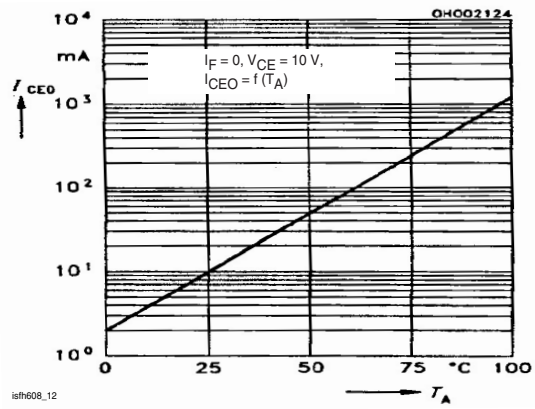
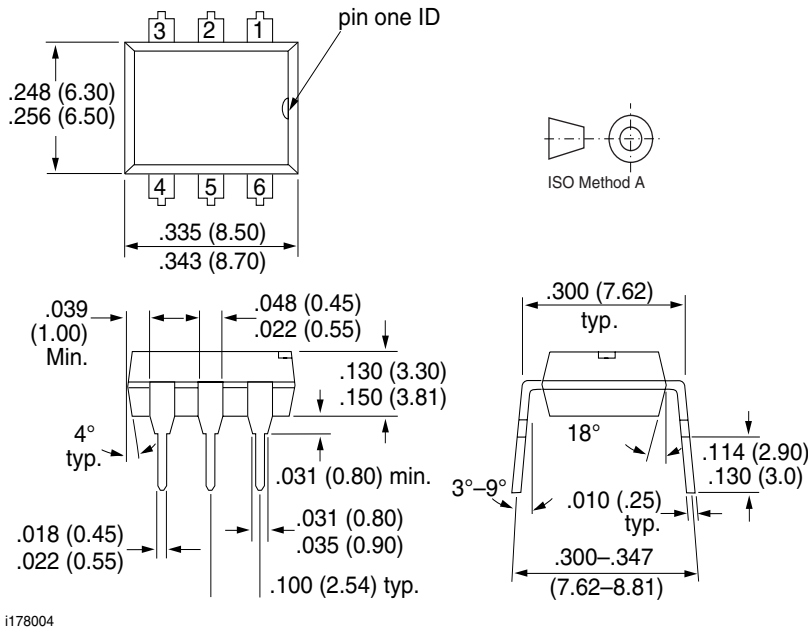
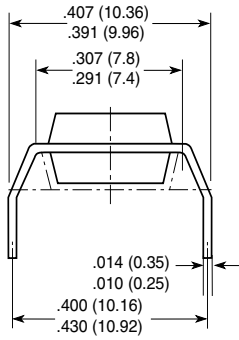

Figure 12. Collector-Emitter Leakage Current vs. Temp.

Package Dimensions in Inches (mm)



Option 6



Option 7

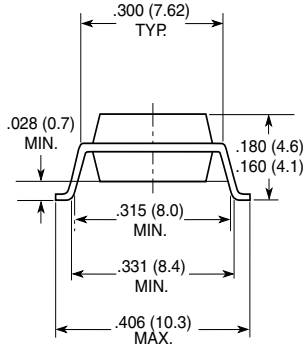

Option 9

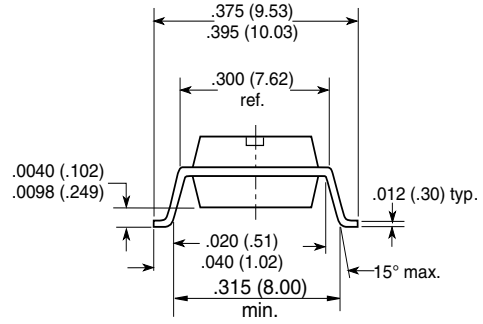

18450

Ozone Depleting Substances Policy Statement

It is the policy of Vishay Semiconductor GmbH to

1. Meet all present and future national and international statutory requirements.
2. Regularly and continuously improve the performance of our products, processes, distribution and operating systems with respect to their impact on the health and safety of our employees and the public, as well as their impact on the environment.

It is particular concern to control or eliminate releases of those substances into the atmosphere which are known as ozone depleting substances (ODSs).

The Montreal Protocol (1987) and its London Amendments (1990) intend to severely restrict the use of ODSs and forbid their use within the next ten years. Various national and international initiatives are pressing for an earlier ban on these substances.

Vishay Semiconductor GmbH has been able to use its policy of continuous improvements to eliminate the use of ODSs listed in the following documents.

1. Annex A, B and list of transitional substances of the Montreal Protocol and the London Amendments respectively
2. Class I and II ozone depleting substances in the Clean Air Act Amendments of 1990 by the Environmental Protection Agency (EPA) in the USA
3. Council Decision 88/540/EEC and 91/690/EEC Annex A, B and C (transitional substances) respectively.

Vishay Semiconductor GmbH can certify that our semiconductors are not manufactured with ozone depleting substances and do not contain such substances.

We reserve the right to make changes to improve technical design
and may do so without further notice.

Parameters can vary in different applications. All operating parameters must be validated for each customer application by the customer. Should the buyer use Vishay Semiconductors products for any unintended or unauthorized application, the buyer shall indemnify Vishay Semiconductors against all claims, costs, damages, and expenses, arising out of, directly or indirectly, any claim of personal damage, injury or death associated with such unintended or unauthorized use.

Vishay Semiconductor GmbH, P.O.B. 3535, D-74025 Heilbronn, Germany
Telephone: 49 (0)7131 67 2831, Fax number: 49 (0)7131 67 2423



Notice

Specifications of the products displayed herein are subject to change without notice. Vishay Intertechnology, Inc., or anyone on its behalf, assumes no responsibility or liability for any errors or inaccuracies.

Information contained herein is intended to provide a product description only. No license, express or implied, by estoppel or otherwise, to any intellectual property rights is granted by this document. Except as provided in Vishay's terms and conditions of sale for such products, Vishay assumes no liability whatsoever, and disclaims any express or implied warranty, relating to sale and/or use of Vishay products including liability or warranties relating to fitness for a particular purpose, merchantability, or infringement of any patent, copyright, or other intellectual property right.

The products shown herein are not designed for use in medical, life-saving, or life-sustaining applications. Customers using or selling these products for use in such applications do so at their own risk and agree to fully indemnify Vishay for any damages resulting from such improper use or sale.

Компания «Life Electronics» занимается поставками электронных компонентов импортного и отечественного производства от производителей и со складов крупных дистрибьюторов Европы, Америки и Азии.

С конца 2013 года компания активно расширяет линейку поставок компонентов по направлению коаксиальный кабель, кварцевые генераторы и конденсаторы (керамические, пленочные, электролитические), за счёт заключения дистрибьюторских договоров

Мы предлагаем:

- Конкурентоспособные цены и скидки постоянным клиентам.
- Специальные условия для постоянных клиентов.
- Подбор аналогов.
- Поставку компонентов в любых объемах, удовлетворяющих вашим потребностям.
- Приемлемые сроки поставки, возможна ускоренная поставка.
- Доставку товара в любую точку России и стран СНГ.
- Комплексную поставку.
- Работу по проектам и поставку образцов.
- Формирование склада под заказчика.
- Сертификаты соответствия на поставляемую продукцию (по желанию клиента).
- Тестирование поставляемой продукции.
- Поставку компонентов, требующих военную и космическую приемку.
- Входной контроль качества.
- Наличие сертификата ISO.

В составе нашей компании организован Конструкторский отдел, призванный помогать разработчикам, и инженерам.

Конструкторский отдел помогает осуществить:

- Регистрацию проекта у производителя компонентов.
- Техническую поддержку проекта.
- Защиту от снятия компонента с производства.
- Оценку стоимости проекта по компонентам.
- Изготовление тестовой платы монтаж и пусконаладочные работы.



Тел: +7 (812) 336 43 04 (многоканальный)

Email: org@lifeelectronics.ru