

# Agilent HDSP-331x/332E/333x/334x Series 7.62 mm (0.3 inch) General Purpose Seven-Segment Display Data Sheet

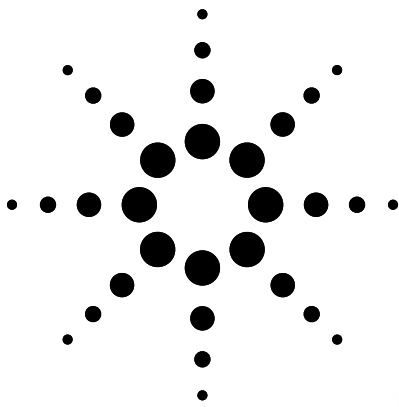

## Description

This 7.62 mm (0.3 inch) LED seven-segment display uses industry standard size package and pinout. The device is available in either common anode

or common cathode. The choice of colors includes High Efficiency Red (HER), Green, AlGaAs Red, and Yellow. The gray face displays are suitable for indoor use.

## Features

- **Industry standard size**
- **Industry standard pinout**  
7.62 mm (0.4 inch) character height  
DIP lead on 2.54 mm
- **Choice of colors**  
High Efficiency Red (HER), Green, AlGaAs Red, and Yellow
- **Excellent appearance**  
Evenly lighted segments gray package gives optimum contrast  
 $\pm 50^\circ$  viewing angle
- **Design flexibility**  
Common anode or common cathode  
Single digit  
Left and right hand decimal point
- **Categorized for luminous intensity**  
Green and yellow categorized for color

## Applications

- **Suitable for indoor use**
- **Not recommended for industrial application, i.e., operating temperature requirements exceeding  $+85^\circ\text{C}$  or below  $-25^\circ\text{C}$ <sup>[1]</sup>**
- **Extreme temperature cycling not recommended**

## Note:

1. For additional details, please contact your local Agilent sales office or an authorized distributor.

## Devices

HER	Green	AlGaAs Red	Yellow	Description	Package Drawing
HDSP-331E	HDSP-331G	HDSP-331A	HDSP-331Y	Common Anode, Right Hand and Left Hand Decimal	A
HDSP-332E				Common Anode, Right Hand and Left Hand Decimal without Pin 4, 5 and 12	A
HDSP-333E	HDSP-333G	HDSP-333A	HDSP-333Y	Common Cathode, Right Hand Decimal	B
HDSP-334E	HDSP-334G	HDSP-334A	HDSP-334Y	Common Cathode, Right Hand Decimal	C



## Part Numbering System

5082 -X X X X-X X X X X

HDSP-X X X X-X X X X X

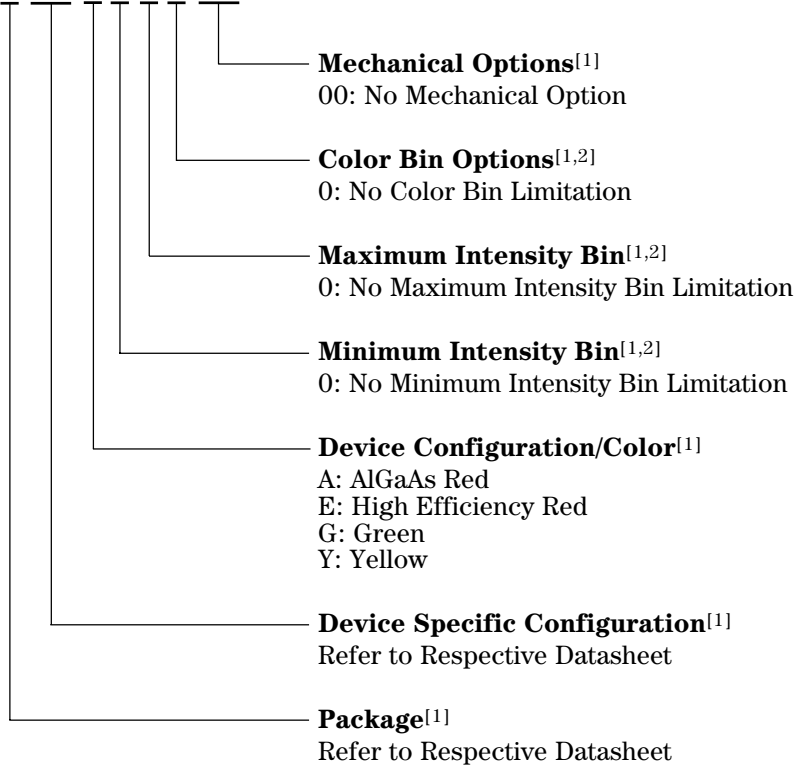

### Notes:

1. For codes not listed in the figure above, please refer to the respective datasheet or contact your nearest Agilent representative for details.
2. Bin options refer to shippable bins for a part number. Color and Intensity Bins are typically restricted to 1 bin per tube (exceptions may apply). Please refer to respective datasheet for specific bin limit information.

# Package Dimensions

## Package Drawing A

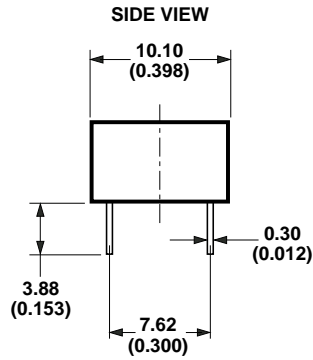
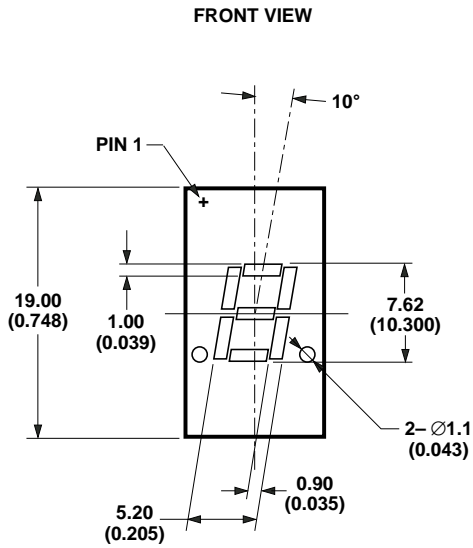

NOTE: HDSP-332E DOES NOT HAVE PIN 4, 5 AND 12.

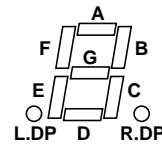
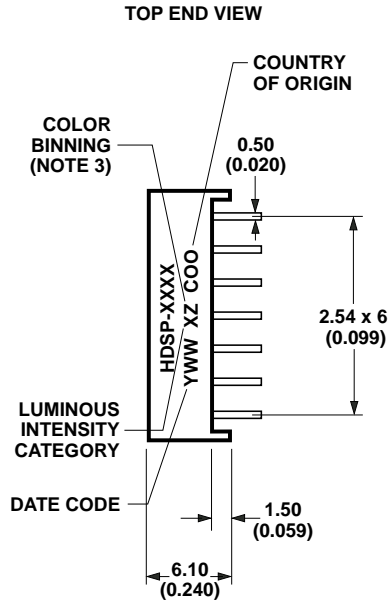

DIMENSIONS IN MILLIMETERS (INCHES)

# Package Dimensions

## Package Drawing B

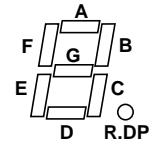
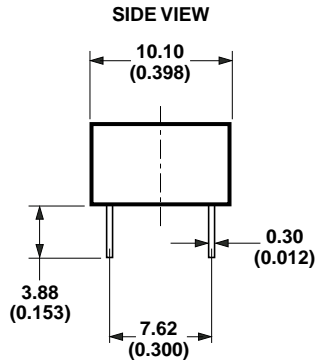
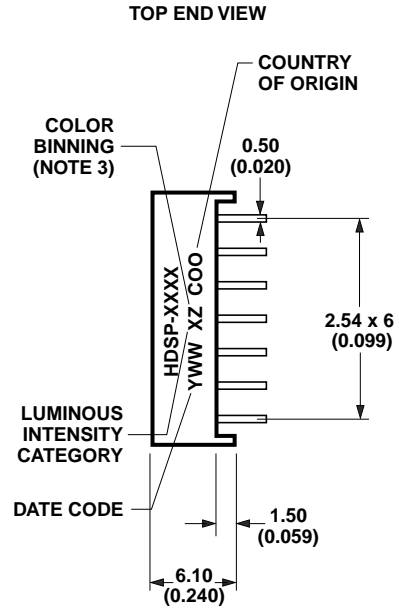
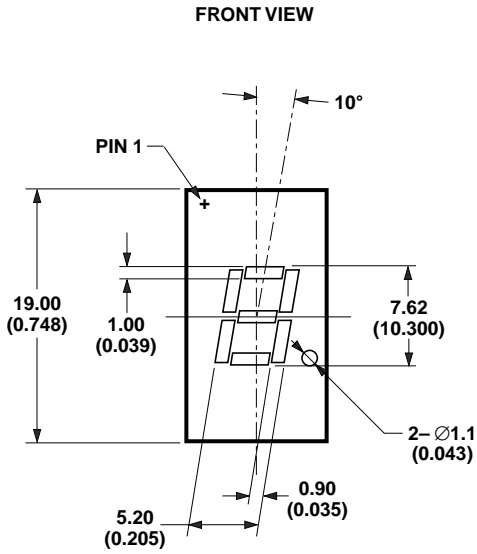

DIMENSIONS IN MILLIMETERS (INCHES)

# Package Dimensions

## Package Drawing C

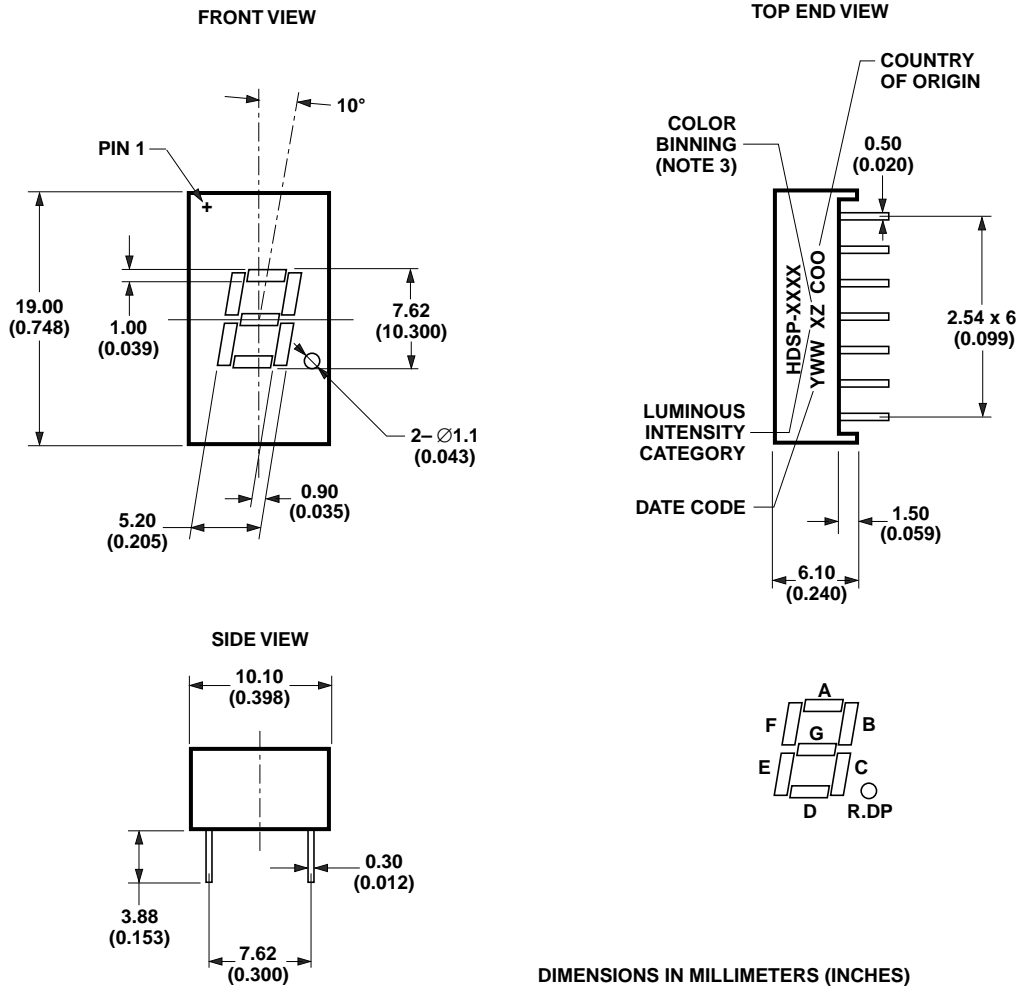

DIMENSIONS IN MILLIMETERS (INCHES)

## Internal Circuit Diagram

### Common Anode

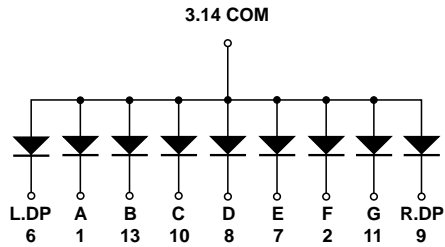

HDSP-331E/331G/331Y/331A/332E

PIN NO.	CONNECTION
1	CATHODE A
2	CATHODE F
3	COMMON ANODE
6	CATHODE L.DP
7	CATHODE E
8	CATHODE D
9	CATHODE R.DP
10	CATHODE C
11	CATHODE G
13	CATHODE B
14	COMMON ANODE
PINS 4, 5, 12: NO CONNECTION FOR HDSP-331E/331G/331Y/331A AND NO PIN FOR HDSP-332E	

### Common Cathode

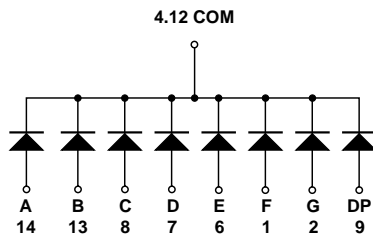

HDSP-333E/333G/333Y/333A

PIN NO.	CONNECTION
1	ANODE F
2	ANODE G
4	COMMON CATHODE
6	ANODE E
7	ANODE D
8	ANODE C
9	ANODE DP
12	COMMON CATHODE
13	ANODE B
14	ANODE A
PINS 3, 5, 10, 11: NC	

## Internal Circuit Diagram

Common Cathode

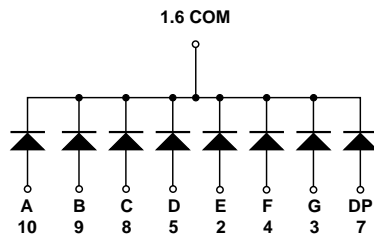

HDSP-334E/334G/334Y/334A

PIN NO.	CONNECTION
1	COMMON CATHODE
2	ANODE E
3	ANODE G
4	ANODE F
5	ANODE D
6	COMMON CATHODE
7	ANODE DP
8	ANODE C
9	ANODE B
10	ANODE A
PINS 11, 12, 13, 14: NC	

### Absolute Maximum Ratings at T<sub>A</sub> = 25 °C

Description	HER HDSP-33xE	Green HDSP-33xG	AlGaAs Red HDSP-33xA	Yellow HDSP-33xY	Units
Power Dissipation Segment	65	65	30	52	mW
Forward Current Segment	25 <sup>[1]</sup>	25 <sup>[2]</sup>	15 <sup>[3]</sup>	20 <sup>[4]</sup>	mA
Peak Forward Current per Segment (1/10 Duty Factor at 10 kHz)	100	100	80	80	mA
Operating Temperature Range	-35 to +85	-35 to +85	-35 to +85	-35 to +85	°C
Storage Temperature Range	-35 to +85	-35 to +85	-35 to +85	-35 to +85	°C
Reverse Voltage per Segment or DP	5	5	5	5	V
Wave Soldering Temperature for 3 Seconds (at 2 mm Distance from the Body)	250	250	250	250	°C

**Notes:**

1. Derate above 25 °C at 0.33 mA/°C.
2. Derate above 25 °C at 0.33 mA/°C.
3. Derate above 25 °C at 0.2 mA/°C.
4. Derate above 25 °C at 0.27 mA/°C.

### Electrical/Optical Characteristics at T<sub>A</sub> = 25 °C

#### High Efficiency Red (HER)

Devices							
HDSP-	Parameter	Symbol	Min.	Typ.	Max.	Units	Test Conditions
331E	Luminous Intensity/Segment	I <sub>V</sub>	0.8	1.15		mcd	I <sub>F</sub> = 5 mA
				1.80		mcd	I <sub>F</sub> = 10 mA
332E	Forward Voltage	V <sub>F</sub>		2.05	2.40	V	I <sub>F</sub> = 20 mA
333E	Peak Wavelength	λ <sub>PEAK</sub>		635		nm	
334E	Dominant Wavelength	λ <sub>d</sub>		620		nm	
	Reverse Voltage	VR	5			V	I <sub>R</sub> = 100 μA

#### Green

Devices							
HDSP-	Parameter	Symbol	Min.	Typ.	Max.	Units	Test Conditions
331G	Luminous Intensity/Segment	I <sub>V</sub>	0.8	2.00		mcd	I <sub>F</sub> = 10 mA
						V	I <sub>F</sub> = 10 mA
333G	Forward Voltage	V <sub>F</sub>	1.80	2.25	2.60	V	I <sub>F</sub> = 20 mA
334G	Peak Wavelength	λ <sub>PEAK</sub>		568		nm	
				573		nm	
	Reverse Voltage	VR	5			V	I <sub>R</sub> = 100 μA



## AlGaAs Red

Devices							
HDSP-	Parameter	Symbol	Min.	Typ.	Max.	Units	Test Conditions
331A 333A 334A	Luminous Intensity/Segment	$I_V$		3.93		mcd	$I_F = 5 \text{ mA}$
			2.001	4.20		mcd	$I_F = 10 \text{ mA}$
	Forward Voltage	$V_F$		1.85	2.00	V	$I_F = 20 \text{ mA}$
	Peak Wavelength	$\lambda_{PEAK}$		660		nm	
	Dominant Wavelength	$\lambda_d$		643		nm	
	Reverse Voltage	$V_R$	5			V	$I_R = 100 \mu\text{A}$

## Yellow

Devices							
HDSP-	Parameter	Symbol	Min.	Typ.	Max.	Units	Test Conditions
331Y 333Y 334Y	Luminous Intensity/Segment	$I_V$		0.71		mcd	$I_F = 5 \text{ mA}$
			0.80	1.50		mcd	$I_F = 10 \text{ mA}$
	Forward Voltage	$V_F$		2.15	2.60	V	$I_F = 20 \text{ mA}$
	Peak Wavelength	$\lambda_{PEAK}$		595		nm	
	Dominant Wavelength	$\lambda_d$		590		nm	
	Reverse Voltage	$V_R$	5			V	$I_R = 100 \mu\text{A}$

## Intensity Bin Limits (mcd at 10 mA)

Bin Name	HER/Green/Yellow		AlGaAs Red	
	Min. <sup>[1]</sup>	Max. <sup>[1]</sup>	Min. <sup>[1]</sup>	Max. <sup>[1]</sup>
G	0.801	1.250	NA	NA
H	1.251	2.000	NA	NA
I	2.001	3.200	2.001	3.200
J	NA	NA	3.201	5.050
K	NA	NA	5.051	8.000

**Note:**

1. Tolerance for each bin limit is  $\pm 10\%$ .

## Color Bin Limits (nm at 10 mA)

Color	Bin	Dominant Wavelength (nm)	
		Min. <sup>[1]</sup>	Max. <sup>[1]</sup>
Green	3	569.1	571.0
	4	571.1	573.0
	5	573.1	575.0
Yellow	1	585.5	588.5
	2	588.5	591.5
	3	591.5	594.5

**Note:**

1. Tolerance for each bin limit is 1 nm.

## High Efficiency Red (HER)

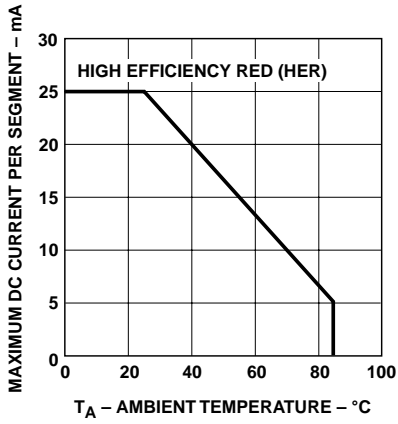

Figure 1. Maximum allowable average or DC current vs. ambient temperature.

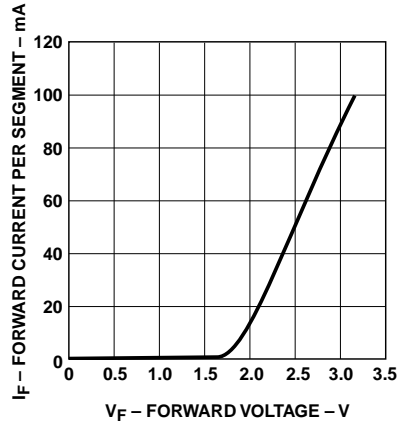

Figure 2. Forward current vs. forward voltage.

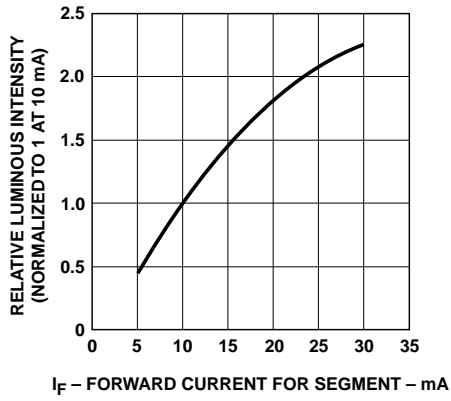

Figure 3. Relative luminous intensity vs. DC forward current.

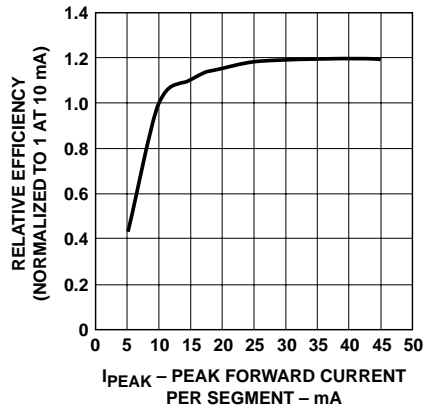

Figure 4. Relative efficiency (luminous intensity per unit current) vs. peak current.

## Green

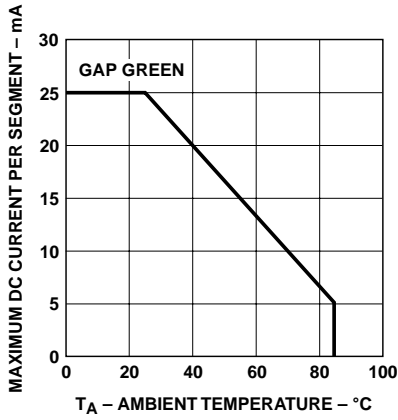

Figure 5. Maximum allowable average or DC current vs. ambient temperature.

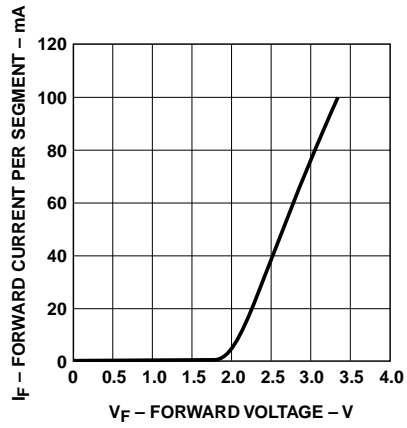

Figure 6. Forward current vs. forward voltage.

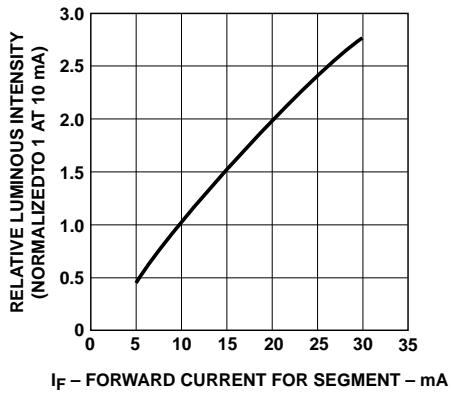

Figure 7. Relative luminous intensity vs. DC forward current.

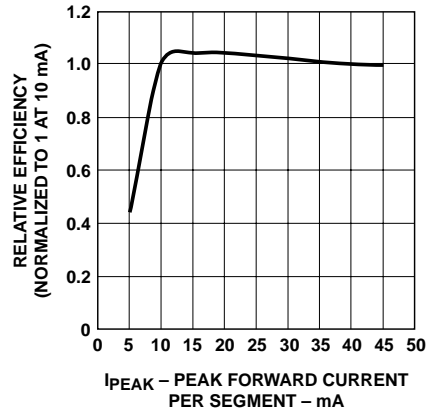

Figure 8. Relative efficiency (luminous intensity per unit current) vs. peak current.

## AlGaAs Red

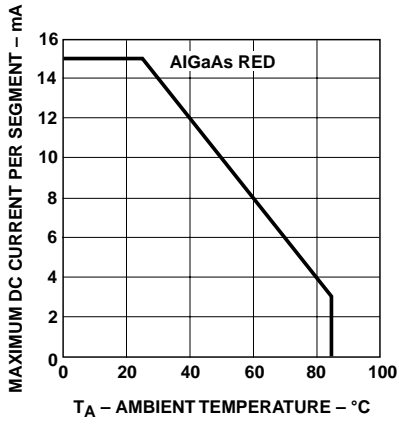

Figure 9. Maximum allowable average or DC current vs. ambient temperature.

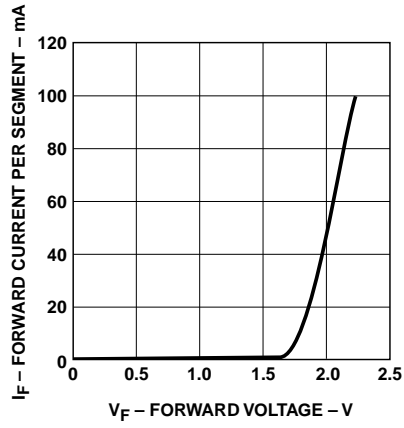

Figure 10. Forward current vs. forward voltage.

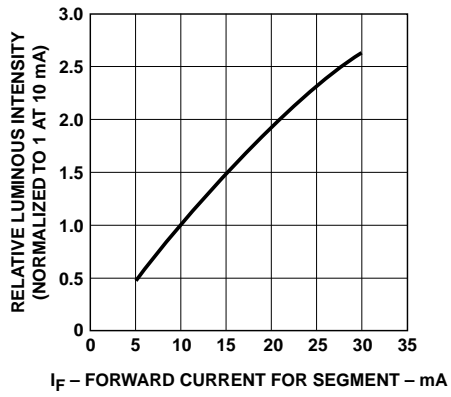

Figure 11. Relative luminous intensity vs. DC forward current.

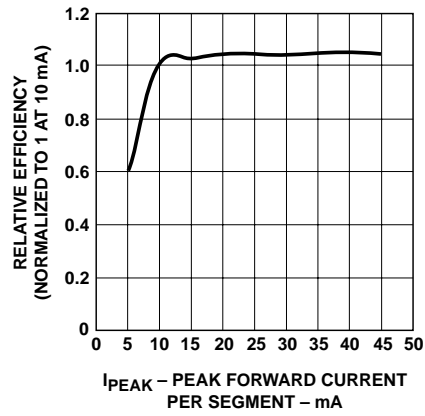

Figure 12. Relative efficiency (luminous intensity per unit current) vs. peak current.

## Yellow

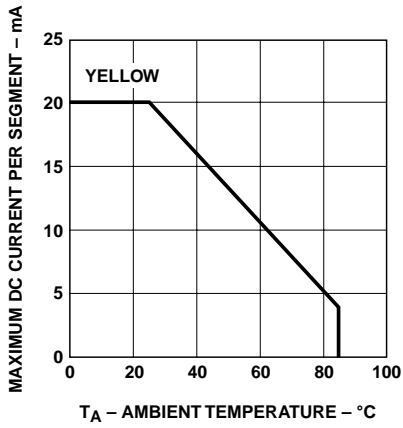

Figure 13. Maximum allowable average or DC current vs. ambient temperature.

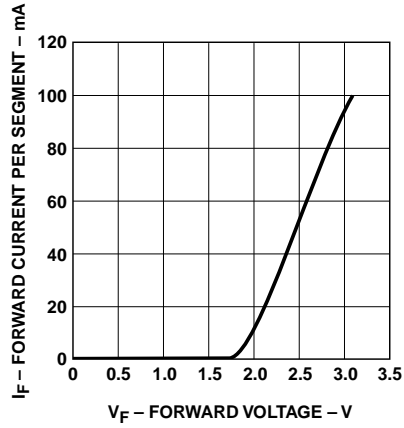

Figure 14. Forward current vs. forward voltage.

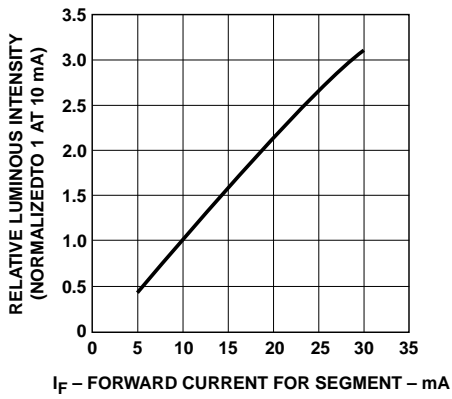

Figure 15. Relative luminous intensity vs. DC forward current.

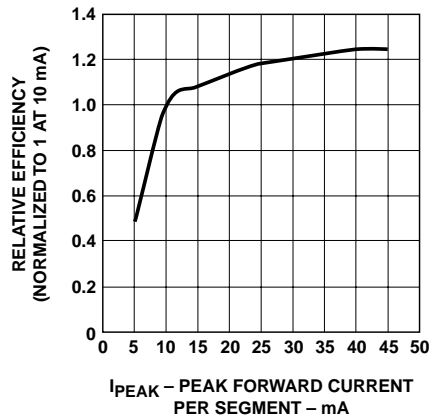

Figure 16. Relative efficiency (luminous intensity per unit current) vs. peak current.

**[www.agilent.com/semiconductors](http://www.agilent.com/semiconductors)**

For product information and a complete list of distributors, please go to our web site.

For technical assistance call:

Americas/Canada: +1 (800) 235-0312 or (916) 788-6763

Europe: +49 (0) 6441 92460

China: 10800 650 0017

Hong Kong: (+65) 6756 2394

India, Australia, New Zealand: (+65) 6755 1939

Japan: (+81 3) 3335-8152(Domestic/International), or 0120-61-1280(Domestic Only)

Korea: (+65) 6755 1989

Singapore, Malaysia, Vietnam, Thailand, Philippines, Indonesia: (+65) 6755 2044

Taiwan: (+65) 6755 1843

Data subject to change.

Obsoletes 5988-2971EN

July 17, 2004

5988-9421EN

Компания «Life Electronics» занимается поставками электронных компонентов импортного и отечественного производства от производителей и со складов крупных дистрибьюторов Европы, Америки и Азии.

С конца 2013 года компания активно расширяет линейку поставок компонентов по направлению коаксиальный кабель, кварцевые генераторы и конденсаторы (керамические, пленочные, электролитические), за счёт заключения дистрибьюторских договоров

Мы предлагаем:

- Конкурентоспособные цены и скидки постоянным клиентам.
- Специальные условия для постоянных клиентов.
- Подбор аналогов.
- Поставку компонентов в любых объемах, удовлетворяющих вашим потребностям.
- Приемлемые сроки поставки, возможна ускоренная поставка.
- Доставку товара в любую точку России и стран СНГ.
- Комплексную поставку.
- Работу по проектам и поставку образцов.
- Формирование склада под заказчика.
- Сертификаты соответствия на поставляемую продукцию (по желанию клиента).
- Тестирование поставляемой продукции.
- Поставку компонентов, требующих военную и космическую приемку.
- Входной контроль качества.
- Наличие сертификата ISO.

В составе нашей компании организован Конструкторский отдел, призванный помогать разработчикам, и инженерам.

Конструкторский отдел помогает осуществить:

- Регистрацию проекта у производителя компонентов.
- Техническую поддержку проекта.
- Защиту от снятия компонента с производства.
- Оценку стоимости проекта по компонентам.
- Изготовление тестовой платы монтаж и пусконаладочные работы.



Тел: +7 (812) 336 43 04 (многоканальный)  
Email: [org@lifeelectronics.ru](mailto:org@lifeelectronics.ru)