

ASF1430

Bidirectional Mass Flow Meter

- Total mass flow integrator
- Data rates up to 200 Hz
- Unique dynamic range: 0.01 sccm – 400 sccm
- Outstanding resolution and accuracy
- Calibrated & temperature compensated
- RS-232
- RoHS compliant



v 2.3 / November 2008

ASF1430 Product Summary

The ASF1430 Mass Flow Meter enables extremely accurate bidirectional measurement of fast changing gas flow over four orders of magnitude. Its leading performance is based on SENSIRION's unsurpassed CMOSens[®] sensor technology which combines a high precision sensor element with the amplification and A/D converter circuit on one single CMOS chip. This results in superior resolution, fast response time and large dynamic range at lowest power consumption. All measurement data is fully calibrated and temperature compensated by means of an internal microcontroller.

Mounted in rugged, chemically inert PBT housing the ASF1430 is suitable for a wide range of applications. Such include mass flow metering for process control, medical applications, heating ventilation and air conditioning (HVAC) solutions, as well as gas flow metrology.

The sensor housing provides two inlets for measuring the gas flow and withstands overpressures of 2 bar (29 psi).

The ASF1430 requires a supply voltage of 7...18Vdc and provides an RS-232.

ASF1430 is RoHS compliant.

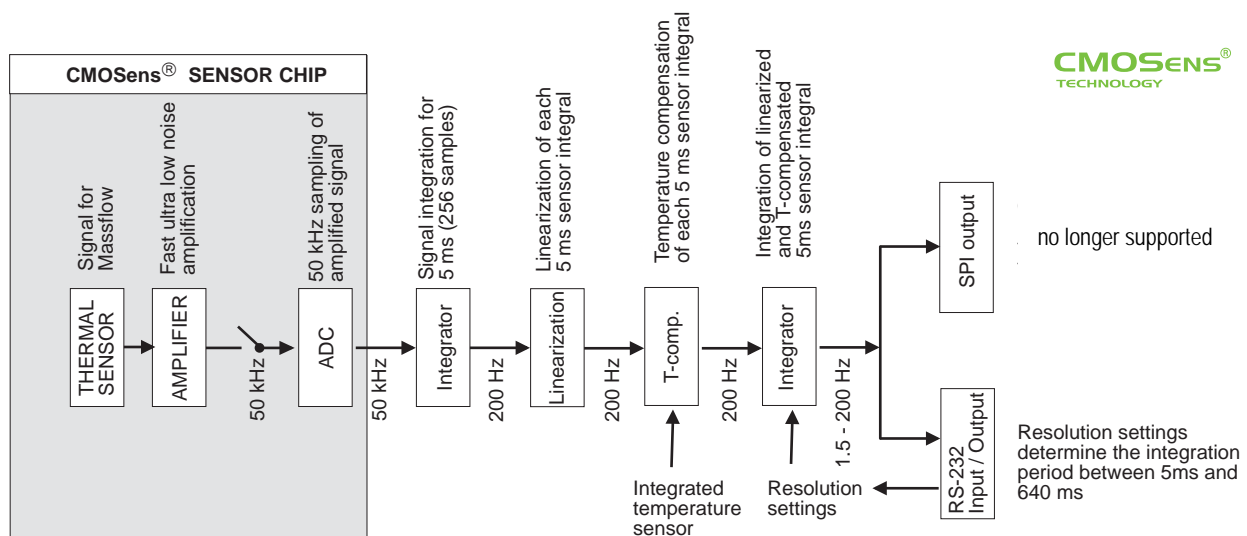

Figure 1: Block Diagram ASF1430 Mass Flow Sensor.

Introductory Description

The heart of the ASF1430 mass flow meter is powered by Sensirion's unsurpassed CMOSens[®] sensor technology. The ASF1430 mass flow meter therefore provides unbeatable performance at very attractive system cost. The lowest detectable gas flow rate is 0.0143 sccm, i.e. a minimum volume of 14.3 mm³ gas per minute can be measured. Covering at the same time a flow range of more than 4 orders of magnitude, the ASF1430 sets a new standard wherever mass flow has to be measured or controlled.

The ASF1430 mass flow sensor runs with an internal flow integration time of 5ms. This allows correct measurement and display of fast changing signals. But very often a precise total flow over a longer period is of higher interest than a fast single measurements. For this purpose the ASF1430 can be set to slower read out times (see 0). The sensor internally still integrates in 5 ms slices and recognizes fast signal changes but for the read out the total flow over the whole period is calculated. The ASF1430 mass flow meter therefore is exceptionally well suited for difficult measurement conditions when fast changing gas flows must be monitored and summed up precisely.

The ASF1430 device measures true mass flow independent of the ambient temperature and pressure changes. You simply connect the gas to be measured to the ASF1430 device to get an instantaneous gas mass flow integral with a selectable integration time between 5 ms and 640 ms.

A flow range between ± 400 sccm can directly be measured by connecting the ASF1430. To increase the range, a bypass can be used in conjunction with the ASF1430 device (see Section 1.5 of this data sheet).

In addition to mass flow, the ASF1430 device provides information about the temperature on the CMOSens[®] sensor element. Both mass flow and temperature data are accessed through an RS-232. The RS-232 interface allows you to directly connect

the ASF1430 device to a PC or PDA using standard terminal software. If a special interface such as 4-20 mA current output or other is required contact Sensirion for a customer specific solution.

In general, all gas types can be measured using the ASF1430. However, the standard calibration gas is nitrogen. Please contact SENSIRION, if you would like to use the sensor for applications with other gases.

ASF1430 is RoHS compliant.

CMOSens[®] sensor technology

CMOSens[®] is the base technology for all Sensirion multi sensor modules and sensor systems. The union of semiconductor chip and sensor technology serves as a platform for highly integrated system solutions with excellent sensor precision and reliability. With CMOSens[®], the on-chip sensor element forms an integrated whole with a high-end amplification and A/D converter circuit. Due to the compact single-chip design, CMOSens[®] based sensors are very resistant to electromagnetic disturbances (EMC), another important technical advantage of this state of the art sensor technology. As a result, CMOSens[®] based multi sensor modules offer excellent sensor precision, fast response time and a very large dynamic measurement range. In addition, the digital intelligence of the CMOSens[®] sensor technology enables digital interfaces that permit an easy link with the system of the customer ("Mount&Sense").

1 Mass Flow Sensor Performance

Table 1: Overview of ASF1430 Gas Sensor Performance (All data for 20°C, 1013 mbar unless otherwise noted).

Parameter	Condition	Minimum	Typical	Maximum	Units
Flow Sensor					
Dynamic Range ¹	direct measurement	-400		400	sccm ²
	Customer specific bypass	unlimited		unlimited	
Resolution ³	400 sccm flow / 640 ms		0.1		sccm
	< 10 sccm flow / 640 ms		0.0143 (1/70)		sccm
Lowest Detectable Flow	< 10 sccm flow / 640 ms		0.0143 (1/70)		sccm
Pressure Drop	400 sccm, $p_{abs} = 1$ bar		120		Pa ⁴
Repeatability			0.0025 % FS ⁵ 0.025 % m.v.		
Accuracy ⁶	23°C	0...5 % of full scale		0.05 % FS	
		5...100 % of full scale		1 % m.v.	
Offset	23°C		< 0.005	< 0.02	% FS
Overpressure Resistance ⁷			1	1.5	bar
Response Time	depends on resolution setting (see 0)	5		640	ms
Operating Temperature		0		70	°C
Ambient Temperature Coefficient	Zero		< 0.0008	< 0.002	% FS / °C
	Span		< 0.03	< 0.08	% measured value / °C
Position Sensitivity	$p_{abs}=1$ bar, small nitrogen flow		±0.004		% FS

Table 2: Additional Specifications of ASF1430.

Specification	Condition	Value	Unit
Temperature Sensor (measured media)			
Dynamic Range		0 – 60 / 32 – 140	°C / °F
Resolution		0.1	K
Accuracy		2	K
Material			
Wetted Materials		Si, Si ₃ N ₄ , SiOx, Gold, Viton®, Epoxy, Glob Top, PBT	
RoHS / WEEE compliance		Yes.	

¹ The calibration is valid up to +-400 sccm but the flow is displayed up to +- 440 sccm. Above 440 sccm an overflow is displayed (see section 1.1)

² 1 sccm = 1 cm³/min at 0°C and 1013mbar pressure (1sccm = 0.001 norm liter).

³ See 0

⁴ 1 bar = 100 000 Pa = 0.9869 atm = 401.9 inch H₂O = 14.5 psi

⁵ Error = % of full scale (FS) or % of measured value(m.v.), whichever is bigger.

⁶ Better calibration available on request. Allow the Sensor to warm up for best results.

⁷ Higher overpressure resistance can be realised in OEM-solutions or see Sensirion Flow Meter EM1.

Table 3: ASF1430 Mass Flow Sensor Resolution at different Flow Levels and integration time.

Flow or Differential Pressure Level	Readout Frequency 200 Hz	Readout Frequency 50 Hz	Readout Frequency 12.5 Hz	Readout Frequency 1.56 Hz
Flow Level				
400 sccm	13 sccm	3.5 sccm	0.9 sccm	0.11 sccm
100 sccm	4.0 sccm	1.0 sccm	0.3 sccm	0.03 sccm
< 10 sccm	1.0 sccm	0.25 sccm	0.06 sccm	0.0143 sccm
Mass Flow Integration Time				
	5 ms	20 ms	80 ms	640 ms

1.1 Gas Flow Characteristics

Figure 2 shows the applied gas flow vs. the digital output of the ASF1430.

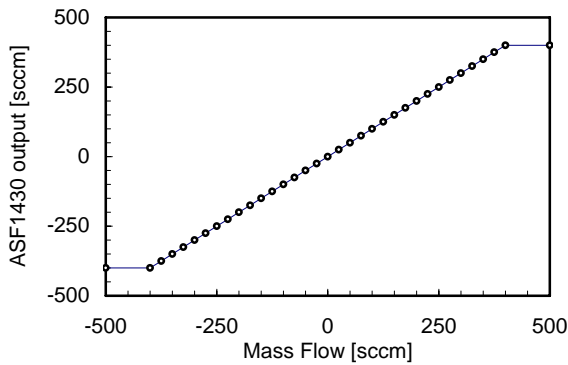

Figure 2: ASF1430 transfer characteristics.

The ASF1430 is bidirectionally calibrated up to a flow of 400 sccm. Between 400 sccm and 440 sccm flow is displayed, but with reduced accuracy. Two types of overflows are reported outside of this expanded range:

1. 'Peak Overflow' if the measured flow was only partly above 440 sccm. In this context it has to be remembered that the ASF1430 mass flow meter averages the flow over a eligible integration time. It can be that the average flow is small but that it periodically exceeds the maximum of 440 sccm and no precise measurement of the average can be guaranteed anymore. This can be checked with a sensor readout at 200 Hz.
2. 'Overflow' if the measured flow is always above the limit of 440 sccm.

1.2 Sensor Principle and Gas Types

The ASF1430 device detects mass gas flow by measuring heat transfer. A heating resistor on a thermally insulated membrane is kept above ambient temperature. In the presence of gas flow, the temperature distribution up- and downstream is disturbed. This asymmetry is then measured. Due to the minimal thermal mass of the membrane, symmetrical arrangement, and accurate temperature measurement, the revolutionary specifications of the ASF1430 devices are achieved.

The above mentioned thermal principle requires information about the gas type to be measured. The ASF1430 is available for air and nitrogen. Other gas types are available on request.

In Figure 3 the repeatability of the ASF1430 devices is compared with the repeatability of a typical Mass Flow Controller (MFC). It emphasizes the superior performance of the ASF1430 device.

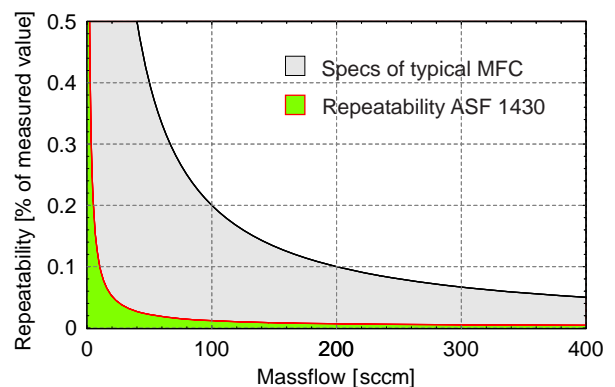

Figure 3: Comparison of the repeatability of the CMOSens® ASF1430 device compared to a typical Mass Flow Controller (MFC).

1.3 Temperature Compensation

The ASF1430 has an automatic temperature compensation implemented. The flow measurement must be suspended for the duration of each update of the temperature measurement. Since these interrupts of the flow measurement shall be short the temperature measurements are only done with a reduced accuracy. They can vary between different measurements and reduce the accuracy of the temperature compensated flow output. The duration of the temperature update is 45 ms which gives a variation of the output of the compensated flow by 0.1% of measured value (for N₂).

Advanced users can choose duration and accuracy of the temperature updates and enhance the accuracy of the temperature compensation even more.

The moment of a temperature update can be controlled in two modes:

- a) Automatically
The temperature measurements are updated automatically in fixed periods which can be set by the command INT (see Table 4).
- b) By Hand
For highest accuracy it is recommended to set INT=0 and initiate the updates through the RS-232 interface with UPDATETEMP (see Table 4). For such measurements it also makes sense to use the option for advanced users to set the duration and accuracy of the temperature update to the maximum.

By default temperature updates are done automatically every 60 seconds (INT=12000).

1.4 Gas Flow and Pressure Difference

The ASF1430 is calibrated for mass flow measurements. However, there is a well defined relation between mass flow and pressure drop. This relation is shown in Figure 4.

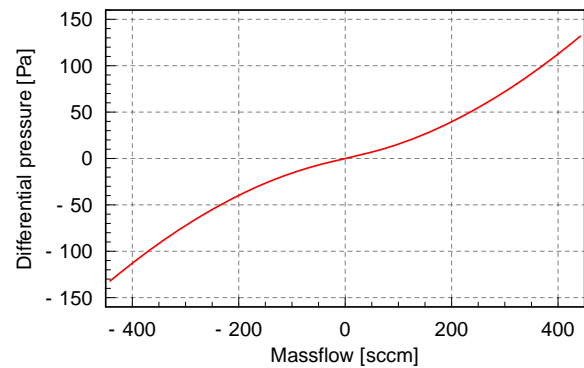

Figure 4: Differential Pressure vs. Mass Flow of ASF1430 Device.

1.5 Adjusting the Measurement Range

To adjust the measurement range, the ASF1430 device is used in conjunction with a bypass configuration (see Figure 5). Only a sample of the total flow actually gets directed through the bypass channel and the sensor system.

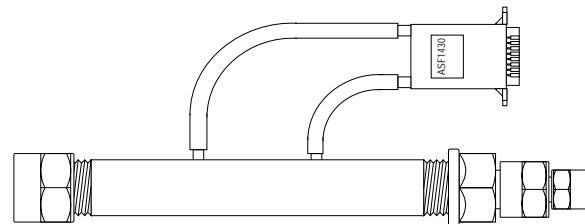

Figure 5: Extending the measurement range of the ASF1430 device using a bypass configuration. Only a sample of the total flow actually gets directed through the bypass channel and the sensor.

2 Pins and Digital Interface

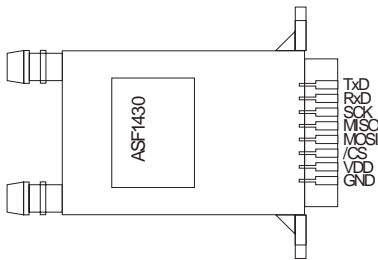

Figure 6: ASF1430 pin out.

GND and VDD (Power Supply)

The ASF1430 requires a voltage supply between 7V and 18 V. Since this voltage is internally regulated, there are no stringent requirements as far as ripple and stability are concerned.

2.1 Digital Interface

The ASF1430 has a bi-directional RS-232 to set configuration and to get flow or temperature values. Dataformat and Interpretation

The received value is a 16 bit signed integer in the two's complement representation. The calibrated data is multiplied by a constant factor and then rounded to the next smaller integer in order to transfer also fractions of an unit through the integer protocol. This factor is **70** for flow and **100** for temperature.

Example: a received value of +1234 (dec) corresponds either to 17.628 sccm in flow mode or 12.34 °C in temperature mode. An explanation of the overflow modes can be found in section 1.1.

received value (hex)	received value (dec)	flow [sccm]	temperature [°C]
0x7852	30802	overflow	--
0x7851	30801	peak overflow	--
0x7850	30800	+440.000	+308.00*
⋮	⋮	⋮	⋮
0x0001	1	+0.014286	0.01
0x0000	0	0.000000	0.00
0xFFFF	-1	-0.014286	-0.01
⋮	⋮	⋮	⋮
0x87B0	-30800	-440.000	-308.00*

*not a possible value, just to show the principle

Figure 7: Interpretation of Integer values

2.2 RS-232 Interface

All configurations (see also Section 3) for the ASF1430 can be set using its RS-232 interface. The following pins are required to communicate with the ASF1430 via RS-232:

- RxD (Receiving Data Line)
- TxD (Transmitting Data Line)
- GND (Ground)

The RS-232 protocol of the ASF1430 is configured as follows:

- Baudrate 19200
- Data Bits 8
- Stop Bits 1
- Parity none
- Protocol none
- Echo the sensor generates an echo

With these settings, the ASF1430 device can be connected to any PC or device with an RS-232. The commands have to be sent in ASCII format, the measurement values are provided as a 16 bit signed integer in binary format with 2 bytes synchronization preceding.

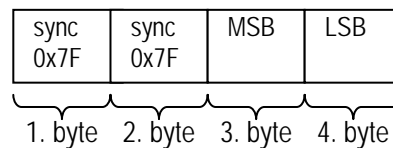

Figure 8: Byte sequence of one value

Because of the maximum range of 0x7852, the high byte never will contain 0x7F. Therefore the worst case is, if the lower byte contains 0x7F. In this special case, 0x7F appears three times in a row.

Example (val=7C 7F):

```

received string: 7F 7F 7C 7F 7F 7F 7C 7F
right sync:     7F 7F 7C 7F 7F 7F 7C 7F
wrong sync:     7F 7F 7F 7C
    
```

The best approach to find the sync in pseudo code: if (buffer[i]=7F and buffer[i+1]=7F and buffer[i+2] <> 7F) then buffer[i] and buffer[i+1] are sync bytes.

2.3 Serial Peripheral Interface (SPI)

The CMOSens® ASF1430 Mass Flow Meter has a bidirectional RS232 to set configuration and to get flow or temperature values. The in earlier versions available SPI interface is no longer specified, due to changed specifications of electronic components. If you require the SPI functionality contact Sensirion.

3 Configuration and Commands

3.1 Device Configuration

The CMOSens® ASF1430 device accepts a set of commands. They can only be sent through its RS232 interface (see Table 4 for valid commands; for correct settings of the RS232 refer to Section 2.1). This allows the user to configure the CMOSens® ASF1430 device. Since the configuration is stored in the internal EEPROM, it is maintained after power interruptions.

With the exception of the stop *s* command, all commands have to be sent in the ASCII-format and terminated by the return key (↵, ASCII #10 or #13). After completion of a command, the CMOSens® MFM returns *ok* and is ready to take a new instruction. Before entering a command, it may be necessary to clear the buffer by means of using ↵.

Table 4: RS232 Interface commands

Command	Output	Description	EEPROM Write Access
help↵	commands	Lists all available commands	
ver↵	version	Provides type of sensor, software, hardware and customer version	
info↵	calibration	Unit / Factor Flow / Overflow / Sensitivity / Factor Temperature	
data↵	serial ID	Sensor Serial Number	
go↵		Starts series of measurements	YES
s	stop	Stops series of measurements	YES
defspi=x↵		SPI-Mode: P=push, G=get (defspi? = Status)	YES
get↵		Start single measurement	YES
mod=F T↵	mode	Selects Flow- (F) or Temperature mode (T), (mod? = Status)	YES
res=0..7↵	resolution	Sets resolution: 0 -> 8 bits; 7 -> 15 bits, see Table 5, (res? = Status)	YES
int=x↵		Interval between automatic internal temperature measurements for an internal update of the temperature compensation. 0=never, {1..2*10 ⁹ }. INT is measured in units of 5 us. INT = 12000 therefore is an update every 60 sec. The duration of an update is 45 ms. Attention : Flow is not measured during this internal temperature update! (INT? = Status).	YES
updatetemp↵		Manual command for an internal temperature measurement for internal update of the temperature compensation. Used with int=0	YES
rdatax↵		reads 4 user defined bytes at the address x={0,...,9}	
wdatax=yyyy↵		writes a maximum of 4 user defined bytes at the address x={0,...,9}	YES
test↵		Sensor Selftest	YES
reset↵		Resets CMOSens® ASF1430 device	

Important Notes:

- The commands are not case sensitive.
- In order to send a new command to the ASF1430 Mass Flow Meter make sure the ASF1430 is not in measurement mode. Issue therefore a stop command *s* first. After this, any instruction can be given to the ASF1430 Mass Flow Meter and a new series of measurement can be started by *go*↵.
- The EEPROM on the ASF1430 has limited write cycles allowed on a memory cell (as true for every EEPROM). The EEPROM on the ASF1430 is specified for a minimum of 1 mio. write cycles on a single memory cell. Some commands rewrite ASF1430 registers in the EEPROM. These commands are marked in the column 'EEPROM Write Access'. Therefore excessive use of one of these commands e.g. for reconfiguration should be avoided. E.g. using the GET command every 5 seconds would reduce the guaranteed life time of the EEPROM to $10e7 / (60/5*60*24) = 60$ days.

3.2 Measurement frequency vs. resolution

There is a trade-off between resolution and measurement time. Possible settings are listed in Table 5. Choosing 12 bit results in a measurement interval of 80 ms. With the max resolution of 15 bit, a new measurement is provided every 640 ms.

Table 5: Resolution settings using the *res=value* command and corresponding response times

res=	Resolution [bit]	Internal signal integration time [ms]	Data rate [Hz]
0	8	5	200
1	9	10	100
2	10	20	50
3	11	40	25
4	12	80	12.5
5	13	160	6.25
6	14	320	3.125
7	15	640	1.56

Table 6: Error Codes

Error Code	Description	Notes
ERROR 01	Invalid command	
ERROR 02	Wrong syntax	
ERROR 03	Value out of range	
ERROR 04	Not allowed mode	
ERROR 05	No permission	
ERROR 06	No permission	
ERROR 50	Invalid EEPROM	
ERROR 99	Internal error	

3.3 Measurement Strategy

As mentioned in paragraph 3.1 (Important Notes) excessive EEPROM write cycles should be avoided. Sensirion therefore recommends to use the ASF1430 in PUSH-mode strategy: The ASF1430 is set to constant measurement mode and is pushing a new measurement once it becomes available. Check Table 5 for the update rate (data rate).

When using the ASF1430 in GET-mode strategy a measurement is started after the GET command only. At each GET command the same EEPROM memory cells are rewritten.

4 Specifications ASF1430

4.1 Absolute Maximum Ratings

Ambient storage temperature	-65°C to 150°C
Ambient operating temperature	0°C to 70°C
Overpressure resistance	2.0 bar

4.2 Electrical Specifications

Table 7: ASF1430 DC Characteristics.

Parameter	Conditions	Min.	Typ.	Max.	Units
Power Supply DC	DC	7	9	18	V
Operating Current	VDD = 9 V, no load		19		mA
	VDD = 9 V, 3k Ω at RS232 output		24		mA
Power Dissipation	VDD = 9 V, no load		171		mW

Table 8: ASF1430 RS-232 Characteristics.

Parameter	Conditions	Min.	Typ.	Max.	Units
RS232 Output					
Output Voltage Swing	Transmitter output loaded with 3k Ω	± 5	± 9		V
Power-Off Output Resistance		300			Ω
Output Short Circuit Current			± 18		mA
RS-232 Input					
Voltage Range		-15		15	V
Voltage Threshold					
Low		0.8	1.2		V
High			1.7	2.4	V
Hysteresis		0.2	0.5	1.0	V
Resistance		3	5	7	k Ω

5 Physical Dimensions and Mounting Information

The ASF1430 is mounted in chemically inert PBT housing. The rugged package has been designed to withstand overpressures of up to 2 bars. Higher pressure packages of up to 10 bars are available on request.

Physical dimensions and mounting information are provided in Figure 9 and Table 8.

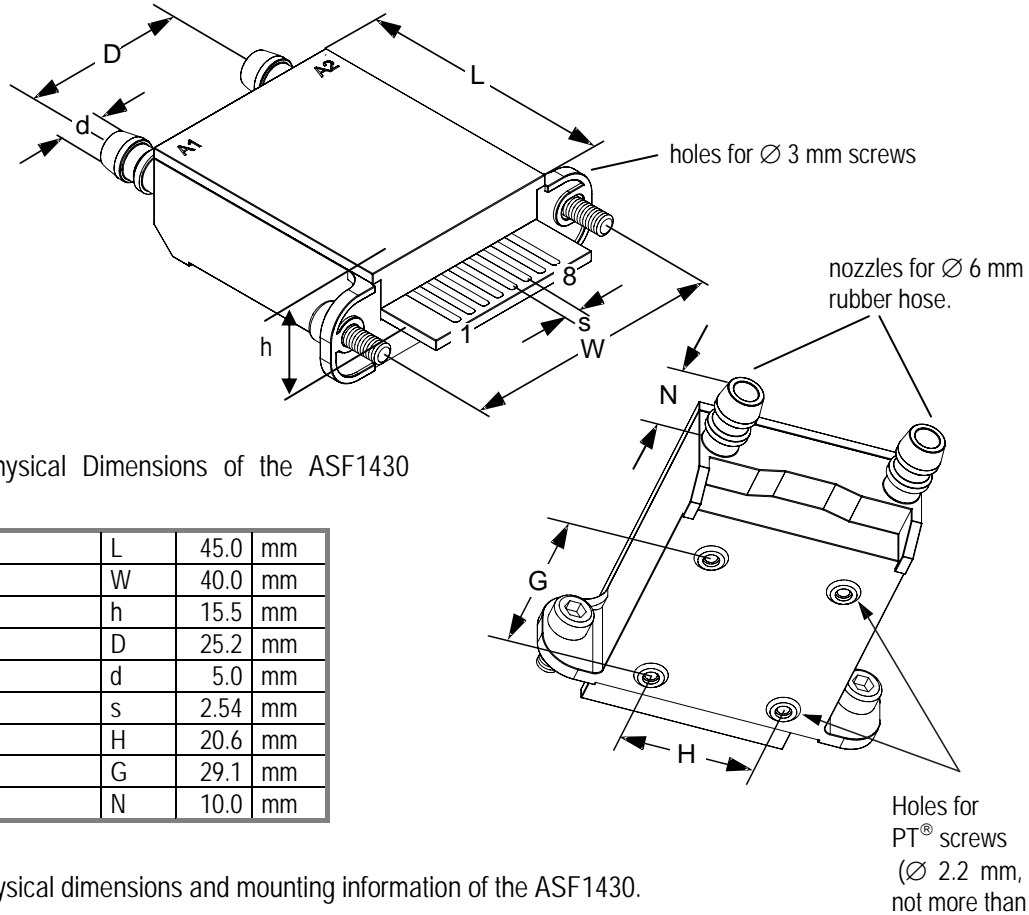

Table 9: Physical Dimensions of the ASF1430 device.

Length	L	45.0	mm
Width	W	40.0	mm
Height	h	15.5	mm
Distance	D	25.2	mm
Diameter	d	5.0	mm
Pitch	s	2.54	mm
Pitch	H	20.6	mm
Pitch	G	29.1	mm
Pitch	N	10.0	mm

Figure 9: Physical dimensions and mounting information of the ASF1430.

5.1 Connector

You need an EDAC 395-010-520-102 connector to connect the sensor. Please check the EDAC homepage for details (www.edac.net).

Alternatively the AVX 00 6338 020 000 04 0 or AVX 00 6338 020 000 04 2 connectors can be used to connect the ASF1400 as well. (See www.farnell.com, order codes 635789 or 635730).

6 Ordering Information

For small ordering quantities the ASF1430 sensor can be ordered directly at Farnell on <http://www.farnell.com>. Farnell is a worldwide distributor of electrical, electronic and industrial component products.

When ordering ASF1430 series devices at SENSIRION please refer to the following part numbers. For the latest product information access SENSIRION's website on <http://www.sensirion.com>

Table 10: Overview ordering information

Calibrated for Gas Type	Range	Packaging	Type
Air	± 400 sccm	2 bar	ASF1430

Notes: For packages to sustain higher common mode pressures check Sensirion Flow Meter EM1.

Important Notices

Warning, personal injury

Do not use this product as safety or emergency stop devices or in any other application where failure of the product could result in personal injury. Do not use this product for applications other than its intended and authorized use. Before installing, handling, using or servicing this product, please consult the data sheet and application notes. Failure to comply with these instructions could result in death or serious injury.

If the Buyer shall purchase or use SENSIRION products for any unintended or unauthorized application, Buyer shall defend, indemnify and hold harmless SENSIRION and its officers, employees, subsidiaries, affiliates and distributors against all claims, costs, damages and expenses, and reasonable attorney fees arising out of, directly or indirectly, any claim of personal injury or death associated with such unintended or unauthorized use, even if SENSIRION shall be allegedly negligent with respect to the design or the manufacture of the product.

ESD Precautions

The inherent design of this component causes it to be sensitive to electrostatic discharge (ESD). To prevent ESD-induced damage and/or degradation, take customary and statutory ESD precautions when handling this product.

See application note "ESD, Latchup and EMC" for more information.

Warranty

SENSIRION warrants solely to the original purchaser of this product for a period of 12 months (one year) from the date of delivery that this product shall be of the quality, material and workmanship defined in SENSIRION's published specifications of the product. Within such period, if proven to be defective, SENSIRION shall repair and/or replace this product, in SENSIRION's discretion, free of charge to the Buyer, provided that:

- notice in writing describing the defects shall be given to SENSIRION within fourteen (14) days after their appearance;
- such defects shall be found, to SENSIRION's reasonable satisfaction, to have arisen from SENSIRION's faulty design, material, or workmanship;

- the defective product shall be returned to SENSIRION's factory at the Buyer's expense; and
- the warranty period for any repaired or replaced product shall be limited to the unexpired portion of the original period.

This warranty does not apply to any equipment which has not been installed and used within the specifications recommended by SENSIRION for the intended and proper use of the equipment. EXCEPT FOR THE WARRANTIES EXPRESSLY SET FORTH HEREIN, SENSIRION MAKES NO WARRANTIES, EITHER EXPRESS OR IMPLIED, WITH RESPECT TO THE PRODUCT. ANY AND ALL WARRANTIES, INCLUDING WITHOUT LIMITATION, WARRANTIES OF MERCHANTABILITY OR FITNESS FOR A PARTICULAR PURPOSE, ARE EXPRESSLY EXCLUDED AND DECLINED.

SENSIRION is only liable for defects of this product arising under the conditions of operation provided for in the data sheet and proper use of the goods. SENSIRION explicitly disclaims all warranties, express or implied, for any period during which the goods are operated or stored not in accordance with the technical specifications.

SENSIRION does not assume any liability arising out of any application or use of any product or circuit and specifically disclaims any and all liability, including without limitation consequential or incidental damages. All operating parameters, including without limitation recommended parameters, must be validated for each customer's applications by customer's technical experts. Recommended parameters can and do vary in different applications. SENSIRION reserves the right, without further notice, (i) to change the product specifications and/or the information in this document and (ii) to improve reliability, functions and design of this product.

Copyright® 2001-2008, SENSIRION.
CMOSens® is a trademark of Sensirion
All rights reserved

RoHS and WEEE Statement

The SDP6x0 family complies with requirements of the following directives:

- EU Directive 2002/96/EC on waste electrical and electronic equipment (**WEEE**), OJ13.02.2003; esp. its Article 6 (1) with Annex II.
- EU Directive 2002/95/EC on the restriction of the use of certain hazardous substances in electrical and electronic equipment (**RoHS**), OJ 13.02.2003; esp. its Article 4.

Revision history

Table 11: Revision history

Date	Version	Page(s)	Changes
Dec. 2001	Preliminary	all	First public release
May 2005	V2.1	all	Specifications, typos, various small modifications
October 2006	V2.2	all	General update. I.e. EEPROM write access recommendation, new disclaimer, introduction of revision history, RoHS compliance
November 2008	V2.3	all	SPI interface no longer supported ,overpressure resistance changed, new ISO-Logo, sales Office Information

Headquarters and Sales Office

Sensirion AG
 Laubisruetistrasse 50
 CH-8712 Staefa ZH
 Switzerland

Phone: + 41 44 306 40 00
 Fax: + 41 44 306 40 30
 e-mail: info@sensirion.com
 Web: www.sensirion.com



Sales Office USA (for North American customers only)

SENSIRION Inc
 Westlake Pl. Ctr. I, suite 204
 2801 Townsgate Road
 Westlake Village, CA 91361
 USA

Phone: +1 805-409 4900
 Fax: +1 805-435 0467
 e-mail: michael.karst@sensirion.com
 Web: www.sensirion.com

Sales Office Korea (for Korean customers only)

Sensirion Korea Co. Ltd.
 #1414, Anyang Construction Twr B/D
 1112-1, Bisan-dong, Anyang-city
 Gyeonggi-Province,
 South Korea

Phone: +82 31-440-9925~27
 Fax: +82 31-440-9927
 e-mail: info@sensirion.co.kr
 Web: www.sensirion.co.kr

Sales Office Japan (for Japanese customers only)

Sensirion Japan Co. Ltd
 Representative Director: Keiichi Hasegawa
 Shinagawa Station Bldg. 7F, 4-23-5, Takanawa,
 Minato-ku, Tokyo, Japan

Tel : +81 3-3444-4940
 Fax: +81 3-3444-4939
 e-mail: info@sensirion.co.jp
 Web: www.sensirion.co.jp

Компания «Life Electronics» занимается поставками электронных компонентов импортного и отечественного производства от производителей и со складов крупных дистрибьюторов Европы, Америки и Азии.

С конца 2013 года компания активно расширяет линейку поставок компонентов по направлению коаксиальный кабель, кварцевые генераторы и конденсаторы (керамические, пленочные, электролитические), за счёт заключения дистрибьюторских договоров

Мы предлагаем:

- Конкурентоспособные цены и скидки постоянным клиентам.
- Специальные условия для постоянных клиентов.
- Подбор аналогов.
- Поставку компонентов в любых объемах, удовлетворяющих вашим потребностям.
- Приемлемые сроки поставки, возможна ускоренная поставка.
- Доставку товара в любую точку России и стран СНГ.
- Комплексную поставку.
- Работу по проектам и поставку образцов.
- Формирование склада под заказчика.
- Сертификаты соответствия на поставляемую продукцию (по желанию клиента).
- Тестирование поставляемой продукции.
- Поставку компонентов, требующих военную и космическую приемку.
- Входной контроль качества.
- Наличие сертификата ISO.

В составе нашей компании организован Конструкторский отдел, призванный помогать разработчикам, и инженерам.

Конструкторский отдел помогает осуществить:

- Регистрацию проекта у производителя компонентов.
- Техническую поддержку проекта.
- Защиту от снятия компонента с производства.
- Оценку стоимости проекта по компонентам.
- Изготовление тестовой платы монтаж и пусконаладочные работы.



Тел: +7 (812) 336 43 04 (многоканальный)
Email: org@lifeelectronics.ru